

SHARP®

DIGITAL MULTIFUNCTIONAL SYSTEM

MODEL: MX-B355W
MX-B455W

Quick Start Guide



BEFORE USING THE MACHINE

Functions of the machine and procedures for placing originals and loading paper



COPIER

Using the copy function



PRINTER

Using the printer function



FACSIMILE

Using the fax function



SCANNER

Using the scan function



DOCUMENT FILING

Storing jobs as files on the hard drive



SYSTEM SETTINGS

Configuring settings to make the machine easier to use

OPERATION MANUALS AND HOW TO USE THEM

Start Guide

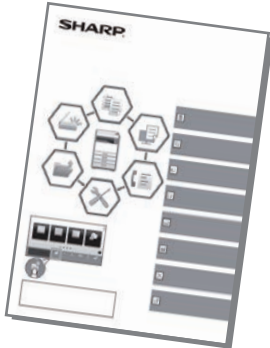

This manual explains basic procedures for using the machine, cautions for safe use of the machine, and information for the administrator. Read this manual before using the machine. For detailed operating procedures and troubleshooting information, see the manuals in PDF format.

Operation Guide (Displayed on the touch panel)



This guide appears when you tap the  icon on the machine's touch panel. The guide explains the basic procedures for operating the machine. In addition, the manuals below can be printed. To print a manual, see "[HOW TO PRINT A MANUAL \(page 4\)](#)".

► [OPERATION PANEL \(page 13\)](#)

Software Setup Guide

This guide explains how to install the software and configure settings to use the machine as a printer or scanner.
(Download only)



Quick Start Guide

This guide is intended to help you get started using the basic and convenient functions of the machine.
(It is the same contents as this manual.)



Web Page Settings Guide

This guide explains the procedures for configuring machine settings from your computer using the web page settings function embedded in the machine.





Like the "User's Manual", these manuals can be downloaded from our website and viewed on your computer.

User's Manual

Detailed explanations of the functions that can be used on the machine are provided in the "User's Manual".
The User's Manual can be downloaded from the machine.
Download the User's Manual from the Web pages in the machine.
For the downloading procedure, see "[DOWNLOADING THE OPERATION GUIDE \(page 6\)](#)".



U/I Customize Guide	Print Release Settings Guide	Troubleshooting
<p>This guide explains how to customize the user interface of the touch panel, such as background and icon images.</p> 	<p>This guide explains how to use the print release function.</p> 	<p>This manual provides answers to frequently asked questions regarding the operation of the machine in each mode.</p> 

HOW TO PRINT A MANUAL

1



Press the [Home Screen] key.

Home screen appears.

2

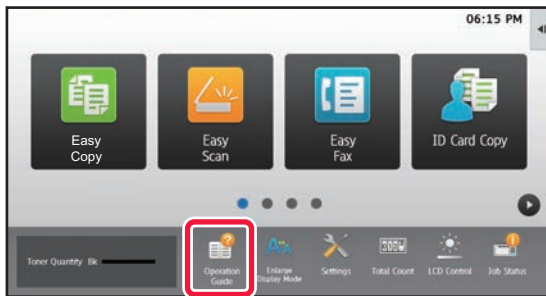

Tap the [Operation Guide] key.

3



Set in a touch panel.

(1) Tap the [Downloading and printing manuals] key.



(2) Tap the [Manuals that can be printed] key.

(3) Tap the manual icon.

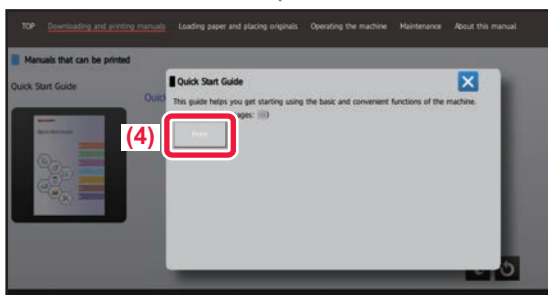

(4) Tap [Print].

The Print Settings screen appears. Select settings and tap the [Start] key to start printing.

ACCESSING THE WEB SERVER IN THE MACHINE

When the machine is connected to a network, the machine's built-in Web server can be accessed from a Web browser on your computer.

OPENING THE WEB PAGES

1

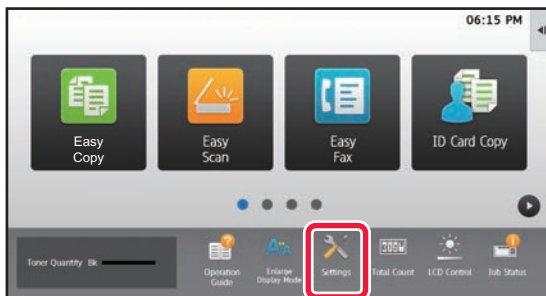

Tap the [Settings] key.

2

Tap [Status] → [Network Status] from the menu.

3

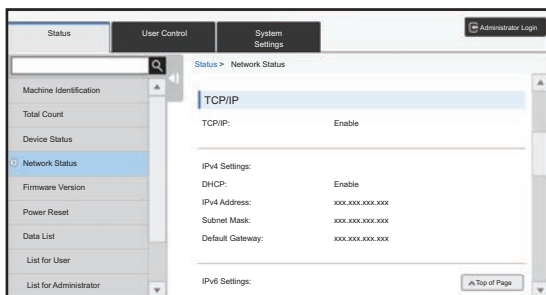

Scroll the screen down and check "IPv4 Address" in IPv4 Settings of TCP/IP.

4



Access the Web server in the machine to open the Web pages.

Start a Web browser on a computer that is connected to the same network as the machine and enter the IP address of the machine.

Recommended Web browsers
Internet Explorer: 10 or higher (Windows®)
Firefox (Windows®), Safari (Mac OS®),
Chrome (Windows®):
Latest version or immediately previous major release

The Web page will appear.
The machine settings may require that user authentication is performed in order to open the Web page. Please ask the administrator of the machine for the password that is required for user authentication.

DOWNLOADING THE OPERATION GUIDE

The Operation Guide, which is a more detailed manual, can be downloaded from the machine's Web pages.

1

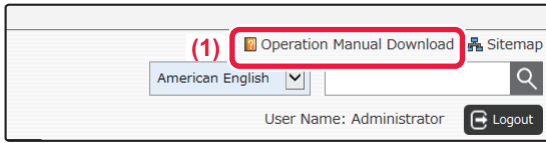

Click [Operation Manual Download] in the menu of the Web page.

2



Select the desired language.

3

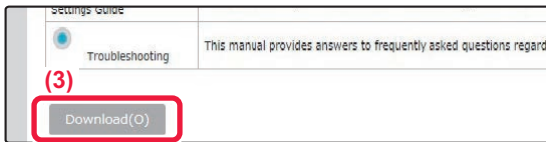

Select the manual you want to download, and click the [Download] button.

TABLE OF CONTENTS

OPERATION MANUALS AND HOW TO USE THEM	2
HOW TO PRINT A MANUAL	4
ACCESSING THE WEB SERVER IN THE MACHINE	5

BEFORE USING THE MACHINE

PART NAMES AND FUNCTIONS	10
TURNING ON/OFF THE POWER	12
OPERATION PANEL	13
PLACING ORIGINALS	15
ADJUSTING THE VOLUME	16
LOADING PAPER	17
SAVING CONTACTS IN THE ADDRESS BOOK	22
USER AUTHENTICATION	23
FUNCTIONS THAT CAN BE USED ON THE MACHINE	24

COPIER

MAKING COPIES	28
COPY MODE	30
COPYING ON SPECIAL PAPER (Bypass Copy)	31

PRINTER

PRINTING IN A WINDOWS ENVIRONMENT	34
PRINTING IN A Mac OS ENVIRONMENT	36
DIRECTLY PRINTING A FILE IN USB MEMORY	38

FACSIMILE

SENDING A FAX	40
FAX MODE	42

SCANNER

NETWORK SCANNER FUNCTION.....	44
SCANNING AN ORIGINAL	45
SCANNER MODE	47

DOCUMENT FILING

USES OF THE DOCUMENT FILING FUNCTION	50
SAVING A DOCUMENT ONLY (Scan to HDD)	51
PRINTING A SAVED FILE.....	54

SYSTEM SETTINGS

SETTING MODE	56
--------------------	----



BEFORE USING THE MACHINE

This section provides general information about the machine, including the names and functions of the parts of the machine and its peripheral devices, and the procedures for placing originals and loading paper.

▶ PART NAMES AND FUNCTIONS	10
▶ TURNING ON/OFF THE POWER.....	12
▶ OPERATION PANEL	13
▶ PLACING ORIGINALS	15
▶ ADJUSTING THE VOLUME	16
▶ LOADING PAPER.....	17
▶ SAVING CONTACTS IN THE ADDRESS BOOK.....	22
▶ USER AUTHENTICATION.....	23
▶ FUNCTIONS THAT CAN BE USED ON THE MACHINE.....	24



PART NAMES AND FUNCTIONS

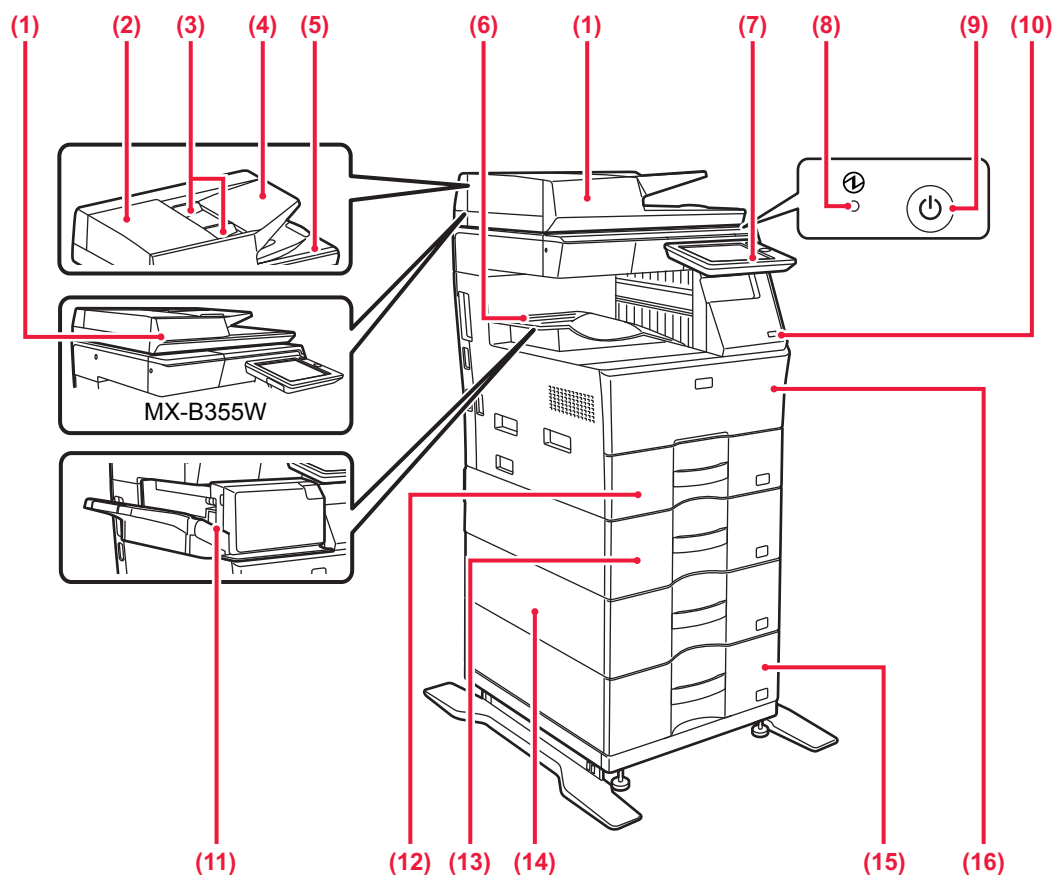

- | | |
|--|---|
| <p>(1) Automatic document feeder
It automatically feeds and scans multiple originals. 2-sided originals can be automatically scanned. For the MX-B455W, both sides of 2-sided originals can be automatically scanned at one time.
▶ USING THE AUTOMATIC DOCUMENT FEEDER (page 15)</p> <p>(2) Document feeding area cover
Open this cover to remove an original misfed or clean the paper feed roller.</p> <p>(3) Original guides
These guides help ensure that the original is scanned correctly. Adjust the guides to the width of the original.</p> <p>(4) Document feeder tray
Place the original.
Place the original with the print side facing up.</p> <p>(5) Original exit tray
The original is discharged to this tray after scanning.</p> <p>(6) Output tray
Output is delivered to this tray.</p> <p>(7) Operation panel
This panel hosts the [Power] button, [Power Save] button/indicator, error indicator, [Home Screen] key, main power indicator, data notification indicator, and touch panel.
Use the touch panel to operate each of these functions.
▶ OPERATION PANEL (page 13)</p> <p>(8) Main power indicator
This lamp lights up when the machine's main power switch is in the " " position.</p> | <p>(9) [Power] button
Use this button to turn the machine's power on and off.</p> <p>(10) USB port (A type)
This is used to connect a USB device such as a USB memory device to the machine.
Supports USB 2.0 (Hi-Speed).
If USB memory devices are connected to both the front and back sides, only the USB memory device that was inserted first will be recognized.</p> <p>(11) Inner finisher*
This staples paper.</p> <p>(12) Tray 1
Store paper in this tray. A maximum of 500 sheets (80 g/m² (20 lbs.)) of paper can be loaded.</p> <p>(13) Tray 2 (when a 600-sheet paper feed unit is installed)*
Store paper in this tray. A maximum of 600 sheets (80 g/m² (20 lbs.)) of paper can be loaded.</p> <p>(14) Tray 3 (when two 600-sheet paper feed units are installed)*
Store paper in this tray. A maximum of 600 sheets (80 g/m² (20 lbs.)) of paper can be loaded.</p> <p>(15) Tray 4 (when three 600-sheet paper feed units are installed)*
Store paper in this tray. A maximum of 600 sheets (80 g/m² (20 lbs.)) of paper can be loaded.</p> <p>(16) Front cover
Open this cover to replace a toner cartridge.</p> |
|--|---|

* Peripheral device. For more information, see the User's Manual.

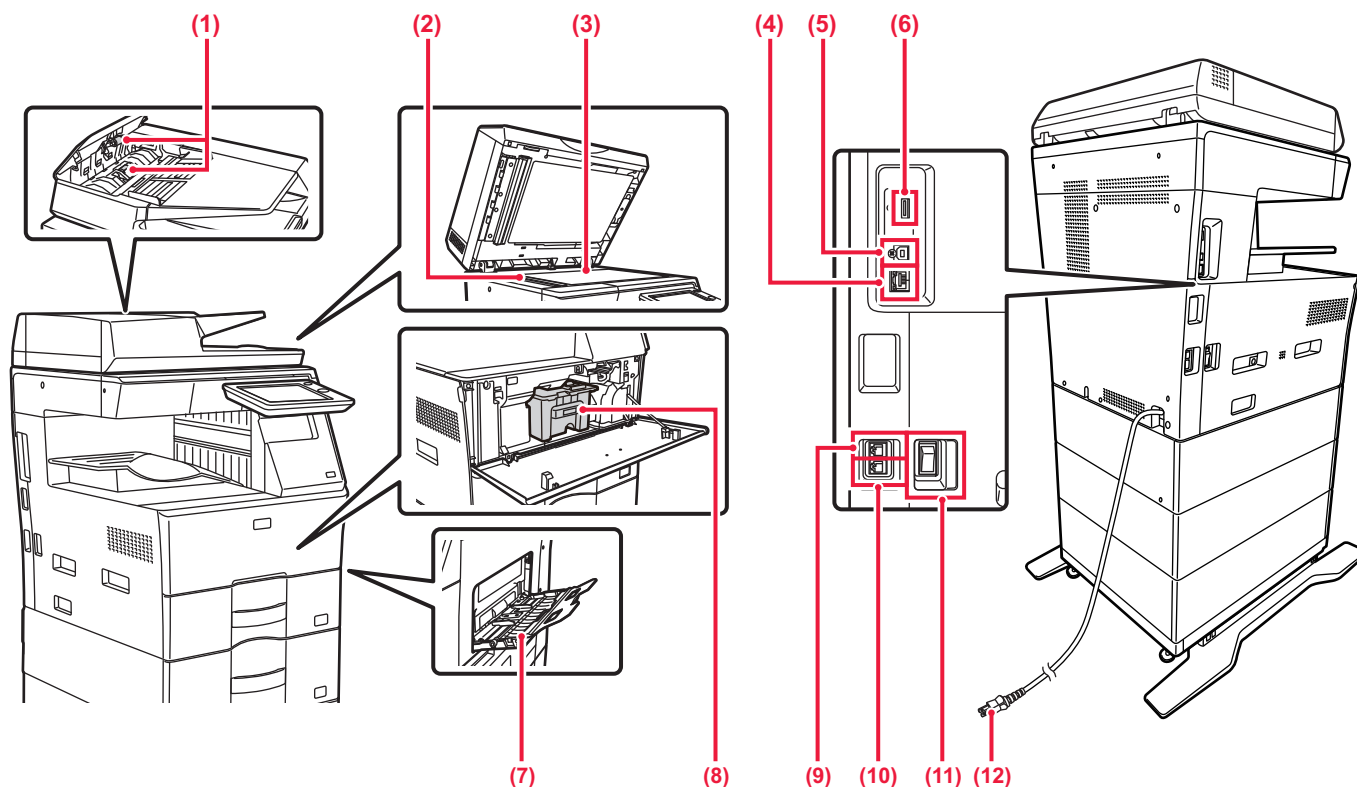

- (1) **Paper feed roller**
This roller rotates to automatically feed the original.
- (2) **Scanning area**
Originals placed in the automatic document feeder are scanned here.
- (3) **Document glass**
If you want to scan books or other thick originals that cannot be fed through the automatic document feeder, place them on this glass.
▶ [USING THE DOCUMENT GLASS \(page 15\)](#)
- (4) **LAN connector**
Connect the LAN cable to this connector when the machine is used on a network.
Use a shielded LAN cable.
- (5) **USB port (B type)**
The machine does not use this connector.
- (6) **USB port (A type)**
This is used to connect a USB device such as a USB memory device to the machine.
Supports USB 2.0 (Hi-Speed).
If USB memory devices are connected to both the front and back sides, only the USB memory device that was inserted first will be recognized.
- (7) **Bypass tray**
Use this tray to feed paper manually.
When loading large paper, open the extension guide.
▶ [Bypass tray \(page 20\)](#)
- (8) **Toner cartridge**
This cartridge contains toner.
When the toner in a cartridge runs out, replace with new one.
- (9) **Telephone line jack (LINE)**
When the fax function of the machine is used, the telephone line is connected to this jack.
- (10) **Extension phone jack (TEL)**
When the fax function of the machine is used, an extension phone can be connected to this jack.
- (11) **Main power switch**
Use this button to turn the machine's power on and off.
When using the fax or Internet fax functions, always keep this switch in the "I" position.
▶ [TURNING ON/OFF THE POWER \(page 12\)](#)
- (12) **Power plug**



TURNING ON/OFF THE POWER

This section describes how to turn on/off the machine's power and how to restart the machine.

Operate two power switches: the main power switch inside the front cover, located in the lower left corner, and the [Power] button on the operation panel.

Turning on the power

- Turn the main power switch to the " | " position.
- When the main power indicator lights in green, press the [Power] button.

Turning off the power

- Press the [Power] to turn off the power.
To turn off the power for an extended time, press the [Power] button to turn off the power, and switch the main power switch to the " ○ " position after the operation panel screen disappears.

Restart the machine

- Turn off the power by pressing the [Power] button and then press it again to turn on the power.

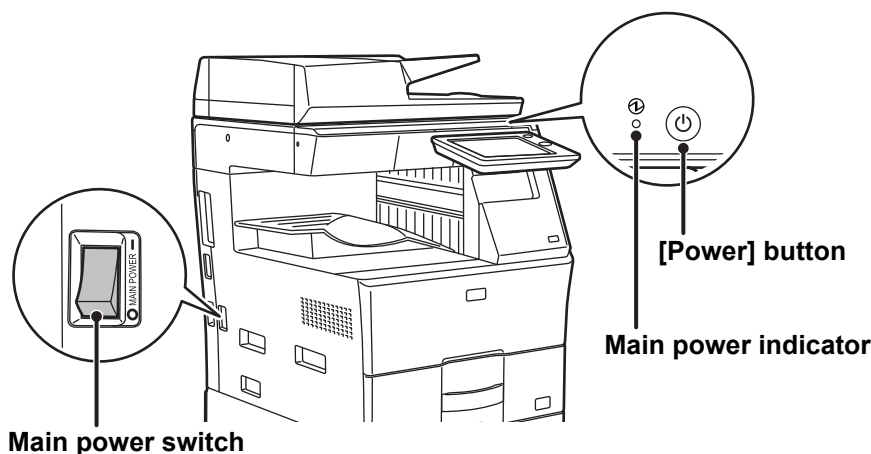

- When turning off the main power switch, press the [Power] button on the operation panel and then turn the main power switch to the " ○ " position.
In a sudden case of main power outage, turn the power for the machine back on and then turn it off in the correct order. If the machine is left for a long time with the main power having been turned off prior to the [Power] button being turned off, abnormal noises, degraded image quality or other problems may result.
- Turn off both the [Power] button and the main power switch and unplug the power cord if you suspect a machine failure, if there is a bad thunderstorm nearby, or when you are moving the machine.



- When using the fax or Internet fax function, always keep the main power switch in the " | " position.
- In order for some settings to take effect, the machine must be restarted. In some states of the machine, restarting with the [Power] button may not make the settings take effect. In this case, turn off the main power switch and then turn it on again.



OPERATION PANEL

Pressing the [Home Screen] key on the operation panel displays the home screen on the touch panel. The home screen displays the keys for selecting modes or functions.

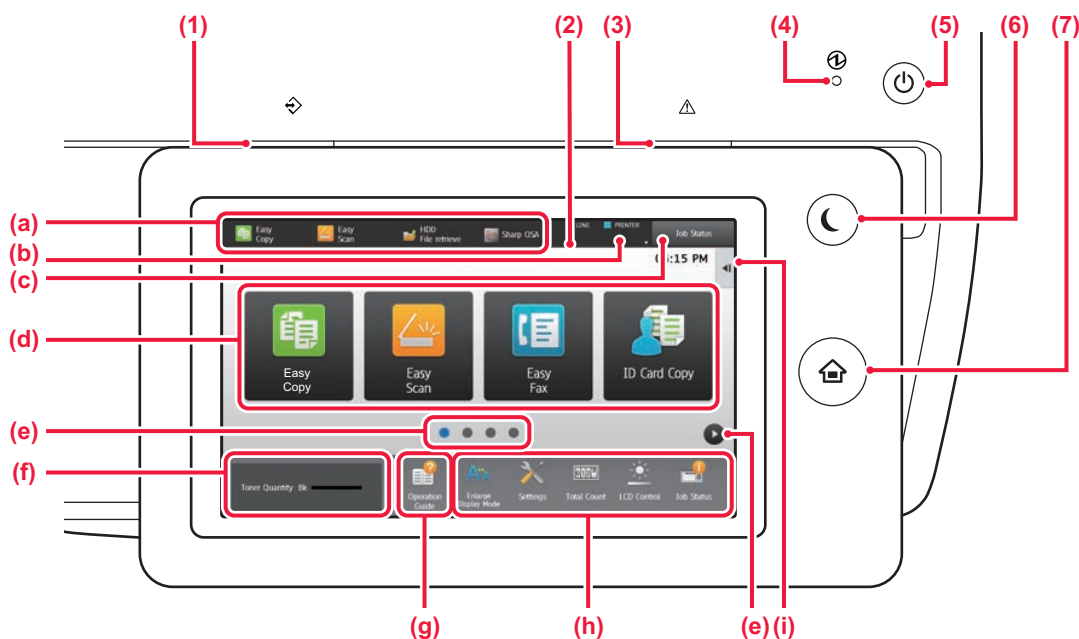

(1) Data notification indicator

Blinks during Fax and Internet Fax reception. When printing is finished, the light turns off. You can also have the indicator light in some modes when a job is being executed, in the ready state, and when an original is detected in the auto document feeder.

(2) Touch Panel

Messages and keys appear on the touch panel display. Operate the machine by directly tapping the displayed keys.

- (a) Tap a mode to change to that mode.
- (b) Display the machine's status other than the job using icons.
- (c) Display the job in progress or waiting with text or icon.
- (d) Select shortcut keys for modes or functions.
- (e) Switch the pages for displaying shortcut keys.
- (f) Display Toner Quantity.
- (g) Display Operation Guide.
- (h) Use these keys to select functions that make the machine easier to use.
- (i) Select functions that can be utilized in respective modes. Tap the tab, and the list of function keys is displayed.

(3) Error indicator

Lights solidly or blinks to indicate the status of the error.

(4) Main power indicator

This lamp lights up when the machine's main power switch is in the "I" position.

While the light is blinking, the power cannot be turned on by pressing the [Power] button.

(5) [Power] button

Use this button to turn the machine's power on and off.

(6) [Power Save] button/indicator

Use this button to set the machine to Sleep Mode for energy saving. [Power Save] button blinks when the machine is in Sleep Mode.

(7) [Home Screen] key

Display the home screen.

To change the angle of the operation panel

You can change the angle of the operation panel. Adjust the angle for ease of viewing.

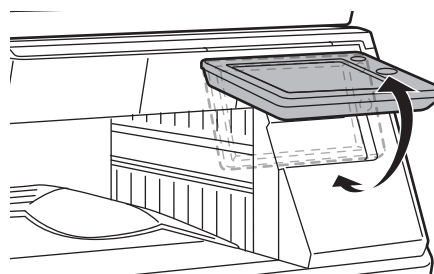



Checking the status of a job / priority / canceling

To display the Job Status screen, tap the [Job Status] key in the home screen, or tap the [Job Status] key that appears in the upper right corner of each mode screen.

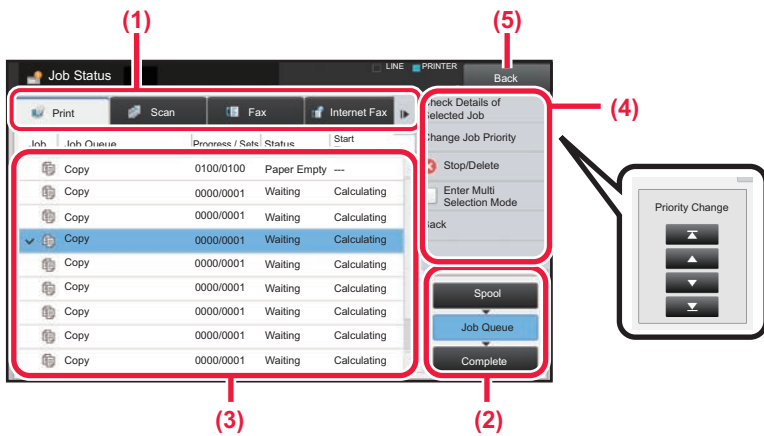

Check the job status

- (1) Tap the tab of the mode you want to check. Check copy jobs and print jobs on the [Print] tab.
- (2) Tap the [Job Queue] or [Complete] key.
- (3) Check the jobs in the list. If you want to give a job priority or cancel a job, tap that job.
- (4) To give the job priority: Tap [Change Job Priority], and tap a Change Priority key.
To cancel the job: Tap [Stop/Delete].
- (5) Tap the [Back] key to return to the original screen.

PREVIEW SCREEN

You can tap the [Preview] key to open the Preview screen. In the Preview screen on the touch panel, you can view previews of jobs and images stored in the machine.

Easy mode

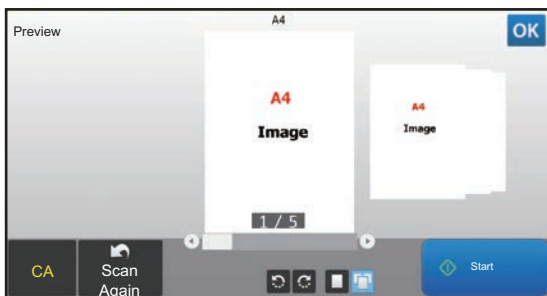

Normal mode

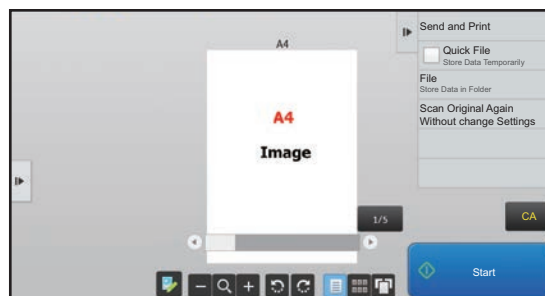

Keys used in the preview screen

	This changes the mode to edit mode. Pages of the original can be changed, rotated, or deleted.		This rotates the preview image of whole page in the arrow's direction. The printing result is not rotated.
	This reduces the image.		This displays preview images of respective pages.
	This displays the scroll bar for enlargement/reduction operations. Moving the slider to the left reduces the image, and moving the slider to the right enlarges the image.		This displays thumbnails of preview images.
	This enlarges the image.		This displays pages in a 3D view.

* Can also be used in easy mode.



PLACING ORIGINALS

The automatic document feeder can be used to automatically scan many originals at once, and this saves you the trouble of manually feeding each original.

For originals that cannot be scanned using the automatic document feeder, such as a book or a document with notes attached, use the document glass.

USING THE AUTOMATIC DOCUMENT FEEDER

When using the automatic document feeder, place the originals in the document feeder tray.

Make sure an original has not been placed on the document glass.

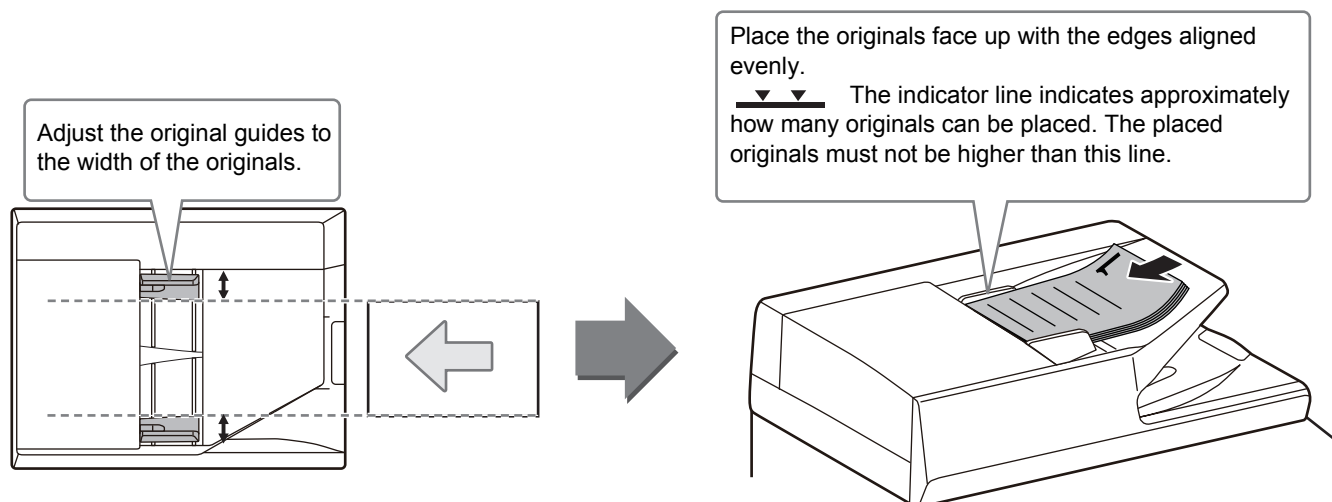

USING THE DOCUMENT GLASS

Take care that your fingers are not pinched when closing the automatic document feeder.

After placing the original, be sure to close the automatic document feeder. If left open, parts outside of the original will be copied black, causing excessive use of toner.

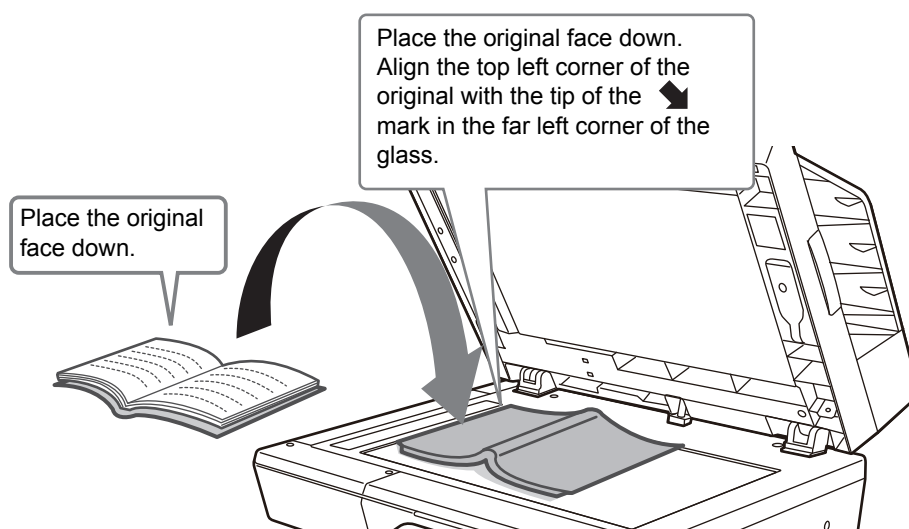

Set the orientation of the image to ensure that the orientation of the placed original is correctly recognized. For details, see the User's Manual.



ADJUSTING THE VOLUME

You can adjust the volume of sounds generated by the machine. Tap the [Settings] key and configure the following settings from the [System Settings] tab.

(Administrator rights are required.)

▶ [Setting mode when an administrator is logged in \(page 58\)](#)

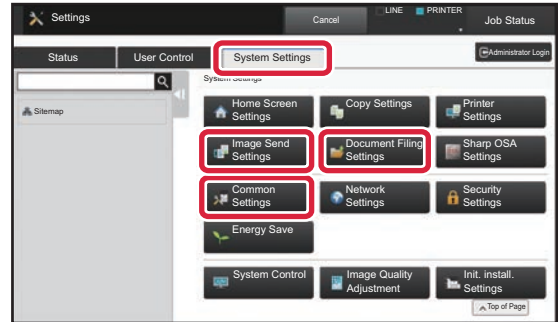
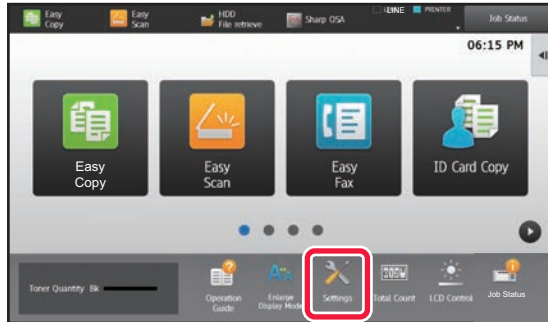

Setting	Settings
Image Send Settings - Common Settings - Condition Settings - Scan Complete Sound Setting	Configure settings for the sound that is generated at the completion of scanning when using the fax, scan, or other image send function.
Image Send Settings - Fax Settings - Default Settings - Speaker Settings	For fax, configure settings for the on-hook (speaker) volume, ringing sound, line monitor, reception completed sound, sending completed sound, and send/receive error sound.
Image Send Settings - Internet Fax Settings - Default Settings - Speaker Volume Settings	Configure settings for sounds generated when an Internet fax is received and when a communication error occurs.
Document Filing Settings - Condition Settings - Scan Complete Sound Setting	Configure settings for the sound that is generated at the completion of scanning when using the document filing function.
Common Settings - Operation Settings - Condition Settings - Key Operation Settings	Configure settings for the sound generated when a key is tapped, and whether a sound is generated when the key for a default setting is tapped.



LOADING PAPER

NAMES AND LOCATIONS OF TRAYS

The names of the trays are as follows.

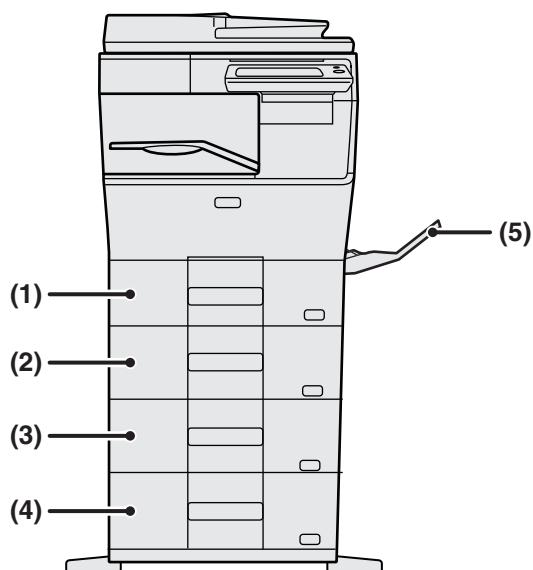

- (1) Tray 1
- (2) Tray 2 (when a 600-sheet paper feed unit is installed)
- (3) Tray 3 (when two 600-sheet paper feed units are installed)
- (4) Tray 4 (when three 600-sheet paper feed units are installed)
- (5) Bypass tray

Setting orientation of the print side

The setting orientation varies for the print side of paper, depending on the tray used. For "Letter Head" and "Pre-Printed", set the paper in the reverse orientation.

Place with the print side facing the direction indicated below.

Tray	In normal status	With letter head or pre-printed paper set
Trays 1 - 4	Facing up	Facing down
Bypass tray	Facing down	Facing up



LOAD PAPER INTO THE TRAY 1 - 4

1

Tray 1

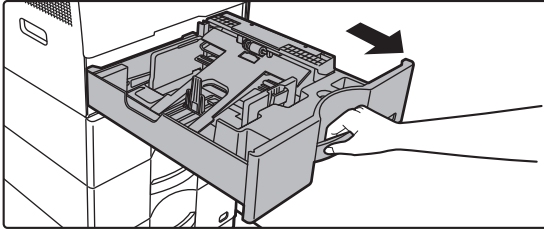

Pull out the paper tray.

Gently pull the tray out until it stops.

To load paper, go to step 3. To load a different size of paper, go to the next step.

Tray 2 - 4

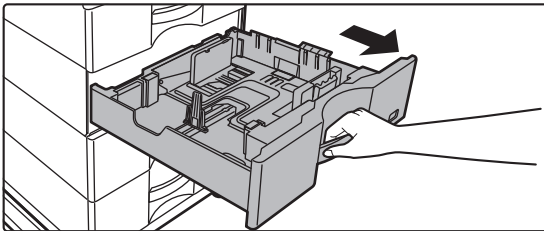

When using the tray 1, push the center of the pressure plate down until it locks into place.

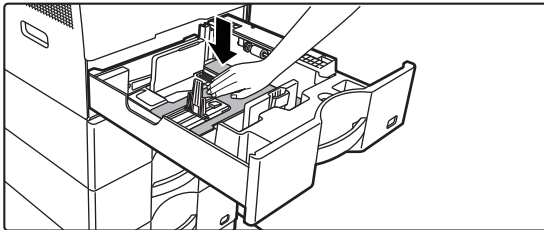

2

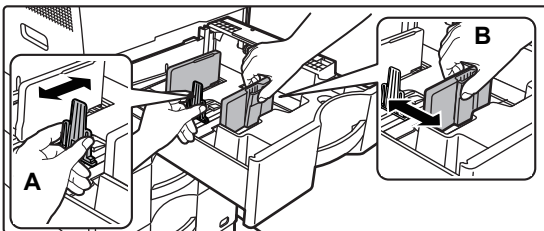

Adjust guide plates A and B to match the longitudinal and transversal dimensions of the paper to be loaded.

The guide plates A and B are slidable. Squeeze the separator plate lever and slide to the desired paper size. Adjust to the non-standard paper size so that the paper will not be too loose or too tight.



- When loading A4 size paper in tray 1, or 8-1/2" x 14" paper in trays 2 to 4, remove divider plate A. Move divider plate A all the way to the paper feed opening (right side), and pull up.

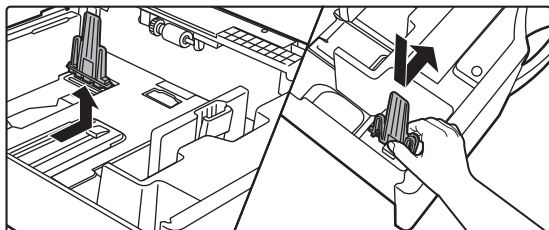

- If the machine does not recognize the paper size even though A4 size is correctly loaded in tray 1, or 8-1/2" x 14" size is correctly loaded in trays 2 to 4, check if the holder in the cassette is positioned at A4 (8-1/2" x 14" in trays 2 to 4).

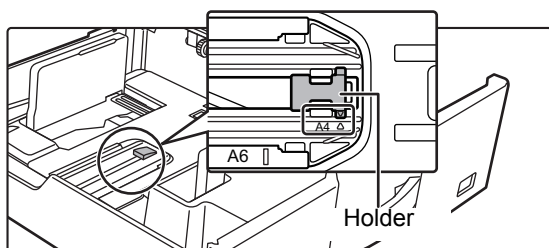

- When setting 8-1/2" x 11" size paper in tray 2 to 4, remove the 2 regulation plates with green color on the front and back side of the tray before setting the paper. The plates are contained in the inside storage space of the back side of the tray.

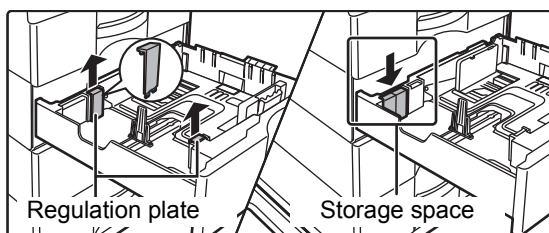

3

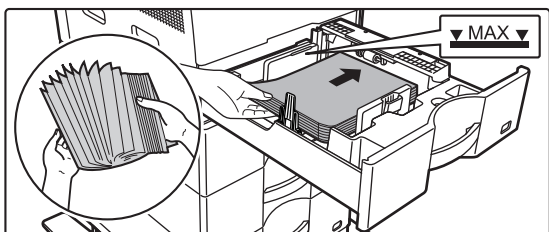

Insert the paper into the tray.

- Load the paper with the print side facing up. The stack must not be higher than the indicator line.
- Fan the paper well before loading it. Otherwise, multiple sheets may feed at once and cause a misfeed.
- Do not load the paper as shown below.



4

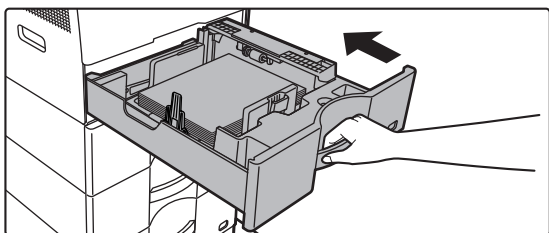

Gently push the paper tray into the machine.

Push the tray firmly all the way into the machine slowly. Forcefully inserting the paper may cause skewed feeding and paper misfeeds.



LOADING PAPER IN OTHER TRAYS

Bypass tray

1

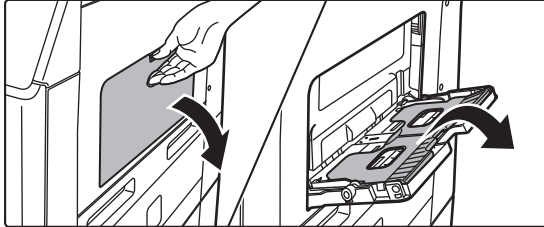

Open the bypass tray and the extension tray.

2

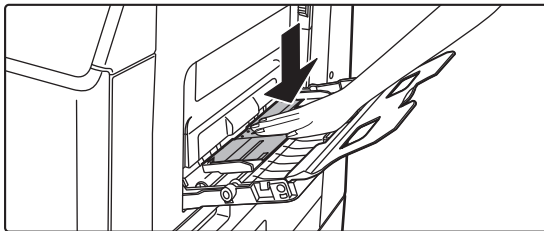

Push the center of the pressure plate down until it locks into place.

3

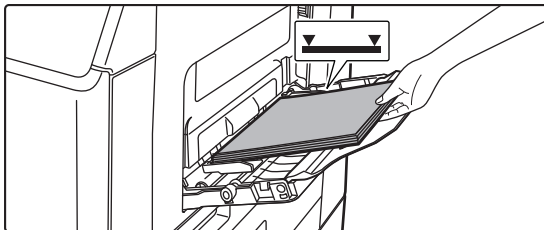

Load the paper with the print side facing down.

Insert the paper along the bypass tray guides all the way into the bypass tray until it stops slowly. Inserting the paper with excessive force may cause the leading edge to fold back. Inserting the paper too loosely may cause skewed feeding or misfeeds.

The paper must not exceed the maximum number of sheets and must not be higher than the indicator line.

4

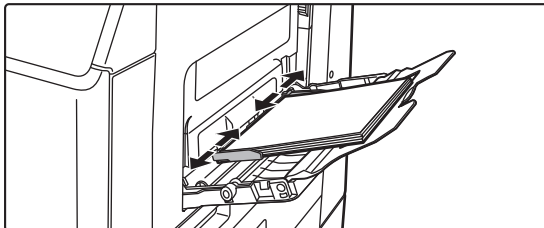

Set the bypass tray guides correctly to the width of the paper.

Adjust the bypass tray guides so that they slightly contact the loaded paper.

Loading envelopes

Only the front side of envelopes can be printed or copied on. Place the front side facing down.

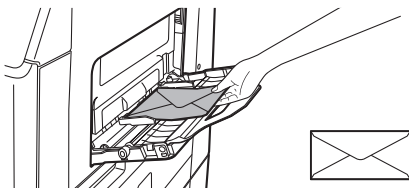

When loading envelopes in the bypass tray, set the paper type.

▶ [CHANGE THE SETTING OF THE PAPER TRAY \(page 21\)](#)



CHANGE THE SETTING OF THE PAPER TRAY

To change the paper loaded in the tray, change the machine's tray settings from the [Tray Settings] key in the home screen. As an example, the steps for changing the paper in tray 1 from 8-1/2" x 11" plain paper to 5-1/2" x 8-1/2" recycled paper are explained below.

1



Press the [Home Screen] key.

Home screen appears.

2

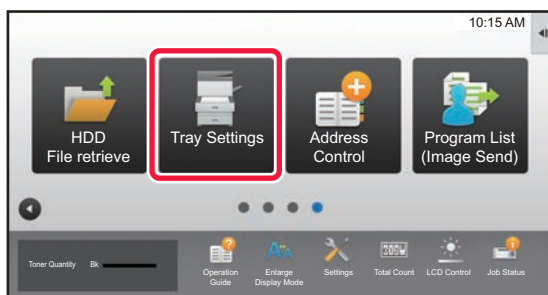

Tap the [Tray Settings] key and tap the key of the paper tray 1.

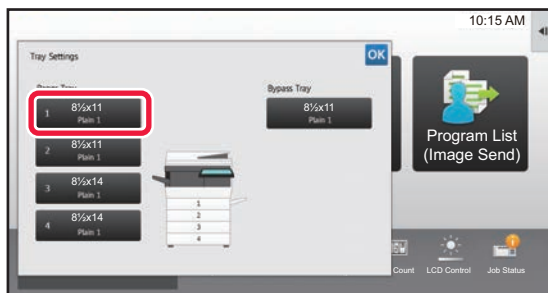

3

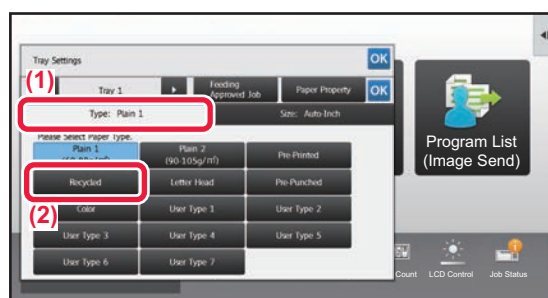

Set the paper type.

(1) Tap the tab for the Paper Type.

(2) Tap the [Recycled] key.

4

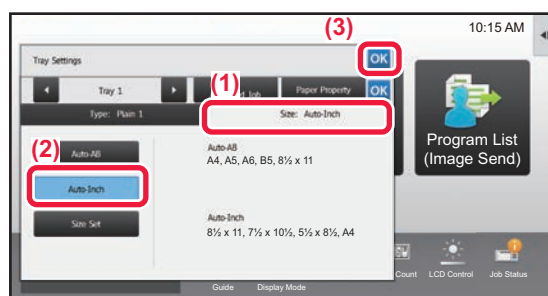

Set the paper size.

(1) Tap the tab for the Paper Size.

(2) Set the paper size.

Tap the [Auto-Inch] key

(3) Tap **OK** in "Tray Settings".



SAVING CONTACTS IN THE ADDRESS BOOK

"Contacts" and "Group" can be stored in the address book.

The procedure for adding a new contact to the address book by directly entering the name and address is explained here as an example.

1



Press the [Home Screen] key.

Home screen appears.

2

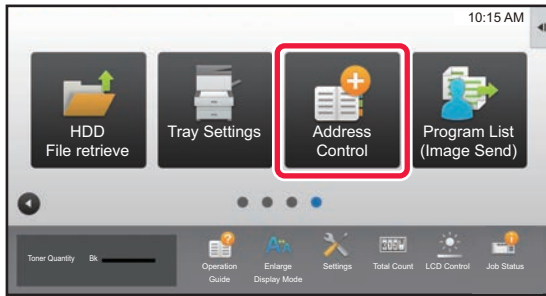

Tap the [Address Control] key.

3

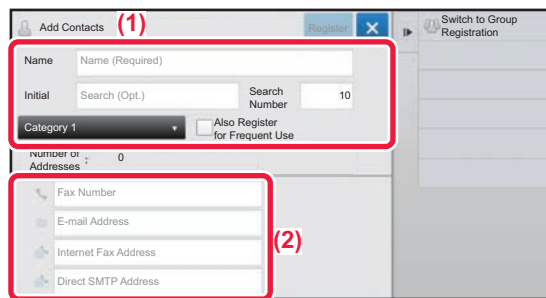

Enter the information you want to register in the address book.

(1) Enter basic information.

Be sure to enter [Name] and [Initial].

To specify a category, select one from a category list that appears when the entry box is tapped.

To register a contact for frequent use, select the [Also Register for Frequent Use] checkbox .

(2) Tap [Fax Number], [E-mail Address], [Internet Fax Address], or [Direct SMTP Address], enter the address, and tap **OK**.

4

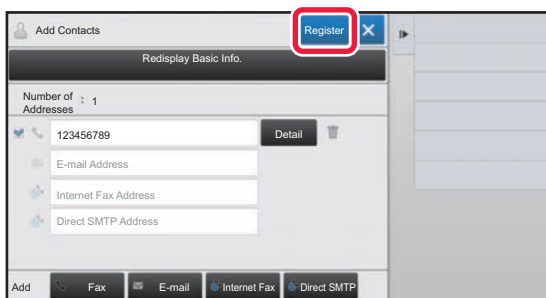

Tap the [Register] key.

The first address of each address type is set as the default address. If no address has the checkbox next to it selected, a confirmation screen will appear asking you if you want to select a default address.

Editing or deleting a contact

Tap the [Address Book] key in the home screen, select the contact to be edited or deleted, tap  in the action panel, and tap [Edit] or [Delete].

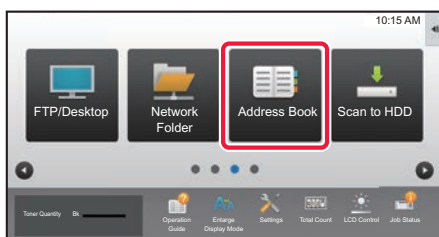



USER AUTHENTICATION

When user authentication is enabled in settings mode, you must log in in order to use the machine. User authentication is disabled in the factory default settings.

When you have finished using the machine, log out.

ABOUT AUTHENTICATION METHODS

There are two user authentication methods: authentication by user number, and authentication by login name / password. Ask the system administrator of the machine for the information you need to log in.

AUTHENTICATION BY USER NUMBER

The following procedure is used to log in using a user number received from the administrator of the machine.

When starting the machine, the login screen appears.

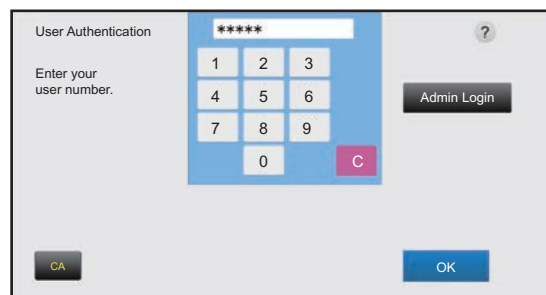

AUTHENTICATION BY LOGIN NAME/PASSWORD

This method enables users to log in using a login name and password received from the administrator of the machine or the administrator of the LDAP server.

When starting the machine, the login screen appears.

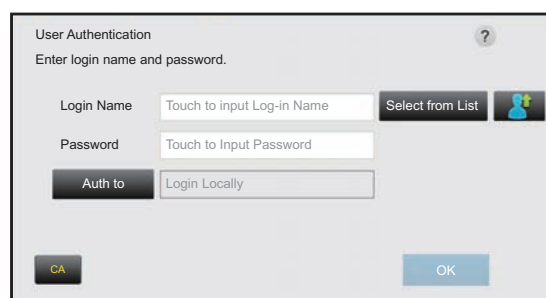

Logout

When you have finished using the machine, log out. This helps prevent unauthorized people from using the machine.





FUNCTIONS THAT CAN BE USED ON THE MACHINE

The machine has many functions for a variety of purposes.

Some convenient functions are described in below. For details, see the User's Manual.

PAPER, AND TIME SAVING FUNCTIONS

N-Up



This function uniformly lays out multiple original pages onto a single sheet of paper. This function is convenient when you wish to present multiple pages in a compact format, or show a view of all pages in a document.

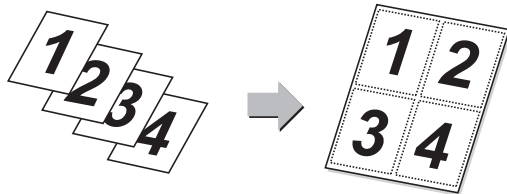

Blank Page Skip



If the scanned original contains blank pages, this function skips them to copy or send only non-blank pages. The machine detects blank pages, enabling you to skip useless blank sheets without checking an original.

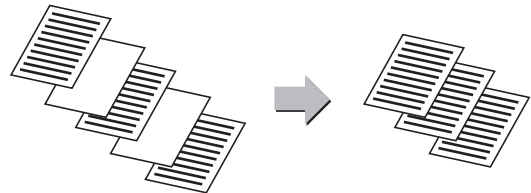

Mixed Size Original



This feature scans originals in different sizes at the same time even when 5-1/2" x 8-1/2" (A5) size originals are mixed with 8-1/2" x 11" (A4) size originals. When copying, you can combine the mixed originals setting and auto ratio setting to change the ratio used for each original and print all pages on the same size of paper.

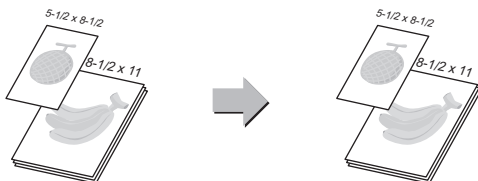

Original Count



Counting the number of scanned original sheets and display the count before transmission. Checking the number of scanned original sheets before transmission helps prevent mistakes.

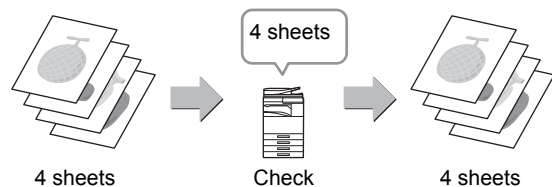

Proof Copy



This function makes a proof copy before printing the specified number of copies. Check the preview image with a proof copy. If necessary, change the setting. Using this function stores the scanned original in the machine, saving you the trouble of re-scanning the original in the changed setting.

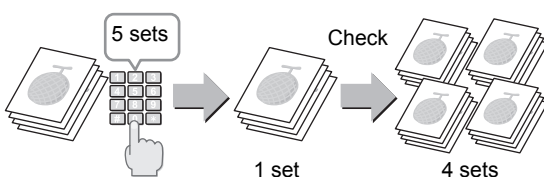

Job Build



This function divides the originals into sets and feeds each set through the automatic document feeder one set at a time when copying or sending a very large number of originals.

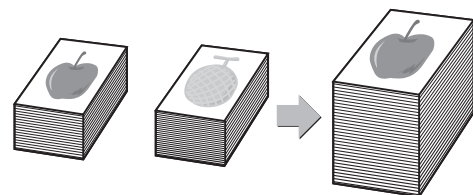



Card Shot



This function copies or sends the front and reverse sides of a card on one sheet, not on separate sheets. This function is convenient for making copies for identification purposes and helping save paper.

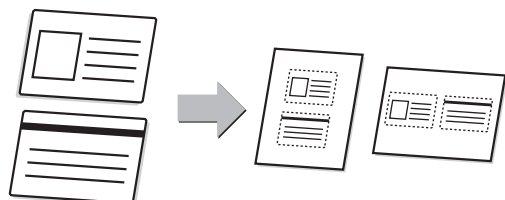

Card Shot (Multi)



Up to four cards placed on the document glass are automatically scanned into separate files, with each file consisting of the front and back of the card.

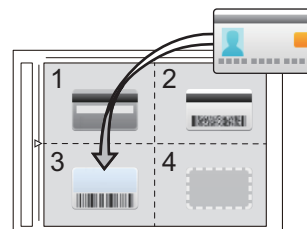

Multi-crop scan / Image Crop



You can place multiple documents such as receipts or photographs on the document glass, and automatically crop and save each document to a separate file during scanning.

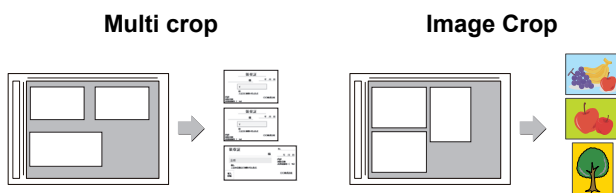

Auto Set



To automatically set scan settings appropriate for the original, tap the [Auto Set] key in the base screen of Easy Mode. Image Orientation, Resolution, and Blank Page Skip are set automatically.

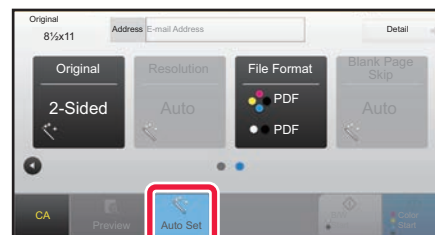



SECURITY REINFORCEMENT FUNCTIONS

Hidden Pattern Print



Characters to prevent unauthorized copying such as pre-set or customized text are placed as invisible characters in a background pattern. When an output sheet with a pattern print is copied, the hidden characters will appear.

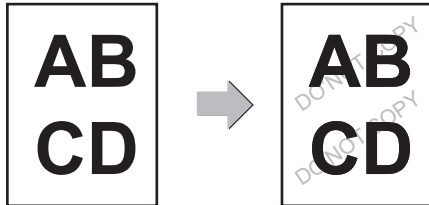

Tracking Information Print



This function forcibly prints the pre-specified traceable information to prevent an unauthorized copy.

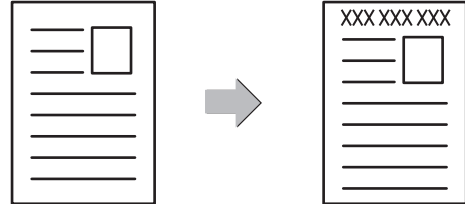

SCANNING FUNCTIONS

Background Adjustment



You can adjust the background by making light areas of the original darker or lighter.

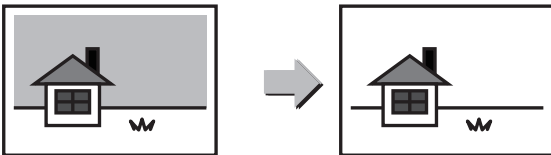

Slow Scan Mode



Use this function when you wish to scan thin originals using the automatic document feeder. This function helps prevent thin originals from misfeeding.

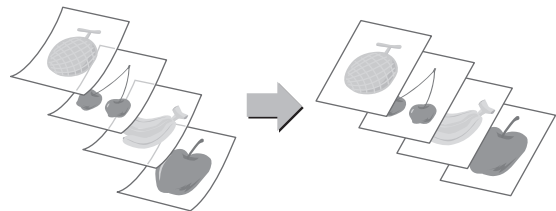

Erase



The erase function is used to erase shadows on images produced when scanning thick originals or books.

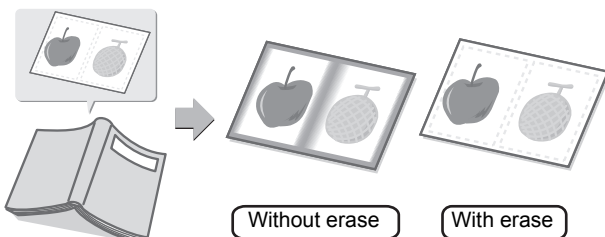



COPIER

This section explains the basic procedures for using the copier function.

▶ MAKING COPIES	28
▶ COPY MODE	30
▶ COPYING ON SPECIAL PAPER (Bypass Copy)	31



MAKING COPIES

This section explains how to set a Copy Ratio.

1



Press the [Home Screen] key.

Home screen appears.

2

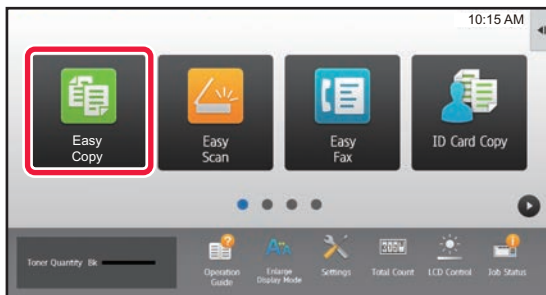

Tap the [Easy Copy] mode icon.

Easy Copy mode screen appears.

3

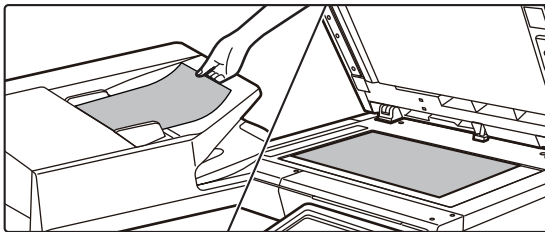

Place the original.

Place the original in the document feeder tray of the automatic document feeder, or on the document glass.

▶ [PLACING ORIGINALS \(page 15\)](#)

4

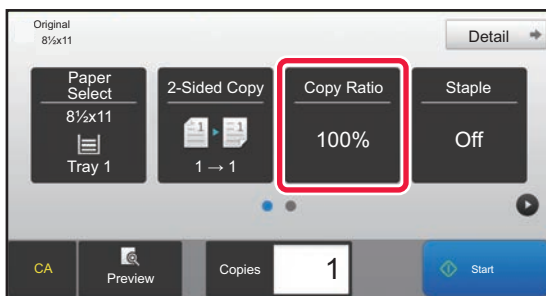

Tap the [Copy Ratio] key.

The functions below can be enabled in easy mode.

- Paper Select
- 2-Sided Copy
- Copy Ratio
- Staple*
- Original
- Exposure
- N-Up
- Card Shot

* When an inner finisher is installed.

To select more detailed settings, tap the [Detail] key and select settings in normal mode.

▶ [COPY MODE \(page 30\)](#)



5

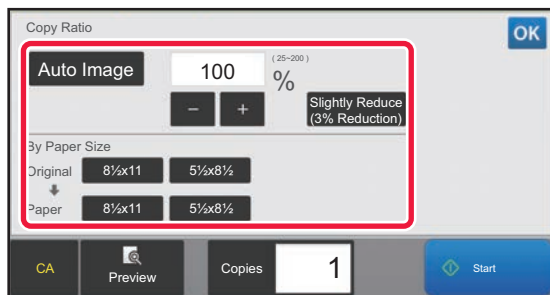

Set the copy ratio.

After the settings are completed, tap **OK**.

6

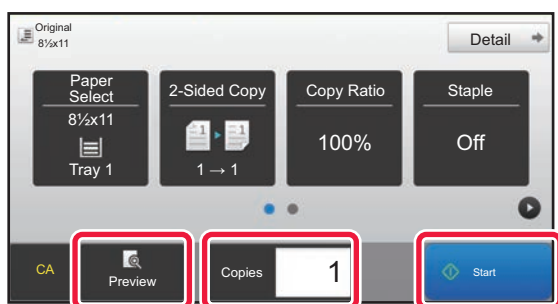

Set the number of copies and then tap the [Start] key.

- To check a preview of a document, tap the [Preview] key.
 - ▶ [PREVIEW SCREEN \(page 14\)](#)

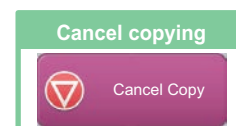



COPY MODE

Copy mode has two modes: easy mode and normal mode.

Easy mode is limited to frequently used functions that allow you to smoothly perform most copy jobs.

If you need to select detailed settings or special functions, use normal mode. All functions can be used in normal mode.

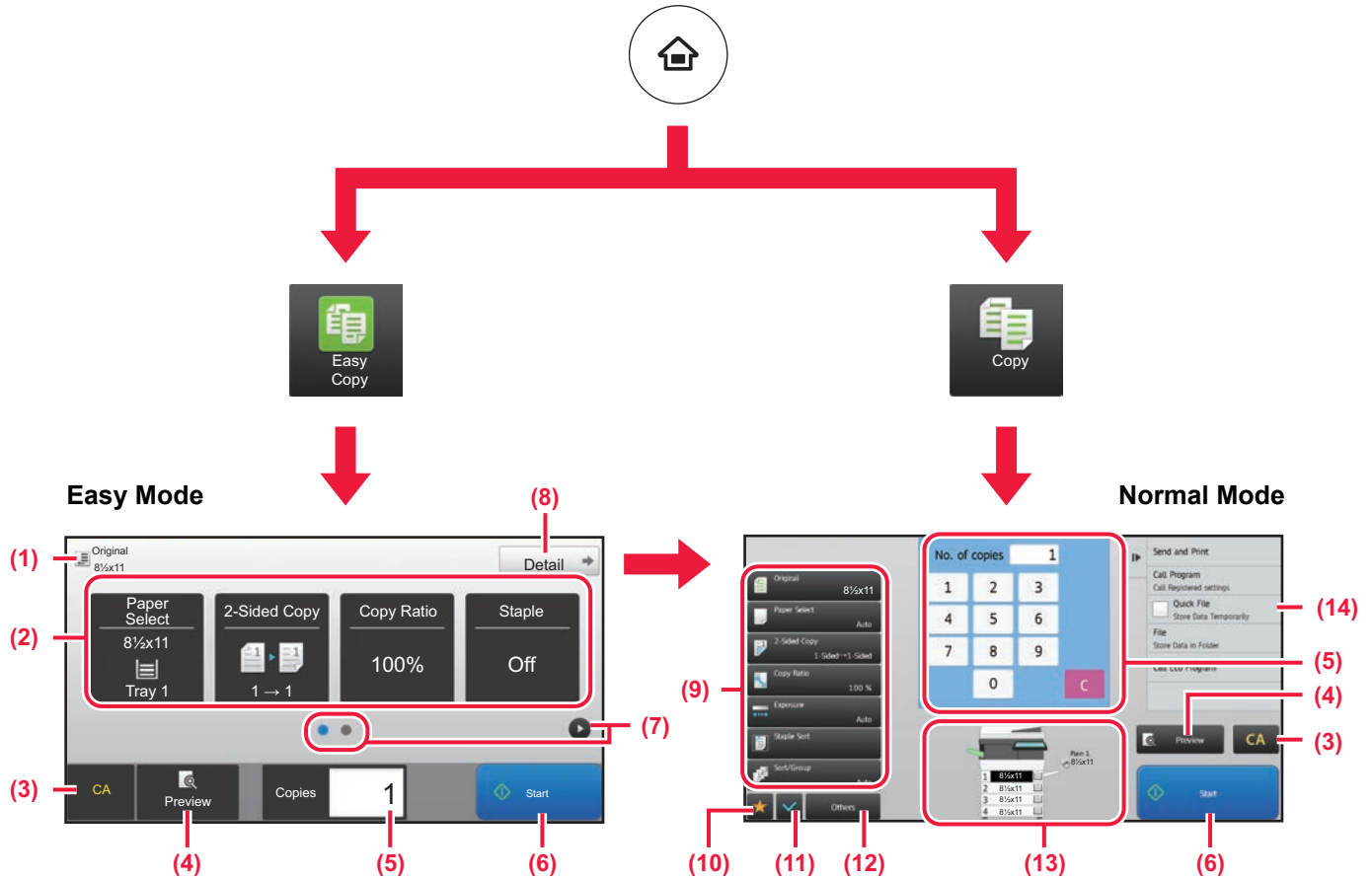

- (1) Show the size of the placed original.
- (2) Select the function that you want to use.

To select a function in easy mode
 In "Settings", select [System Settings] → [Common Settings] → [Operation Settings] → [Easy Mode Settings] → [Easy Copy]

- (3) All settings are reset.
- (4) Scan the original and show a preview image.
 ▶ [PREVIEW SCREEN \(page 14\)](#)
- (5) Enter the number of copies.
- (6) Starts copying.
- (7) Switch the pages for displaying shortcut keys.

- (8) Change to normal mode.
- (9) Setting keys that can be used to make copies.
- (10) Displays the list of function keys. Frequently used [Others] can be registered.
- (11) Check the current settings.
- (12) Displays the list of keys other than the function keys indicated above.
 ▶ [FUNCTIONS THAT CAN BE USED ON THE MACHINE \(page 24\)](#)
- (13) Indicates the presence or absence of an original and size of paper loaded in each tray. Tapping this makes the paper select screen opened.
- (14) Displays the functions that can be utilized in the Copy Mode.



COPYING ON SPECIAL PAPER (Bypass Copy)

This section explains how to load 8-1/2" x 11" heavy paper in the bypass tray.

1

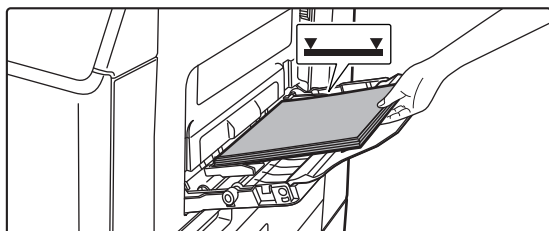

Load paper into the bypass tray.

► [Bypass tray \(page 20\)](#)

2

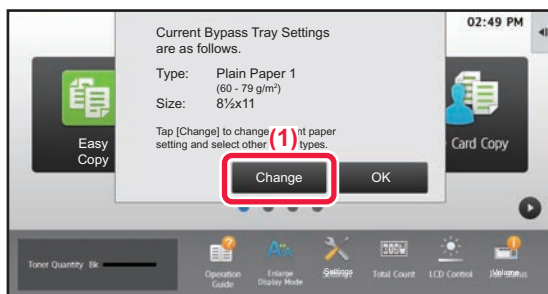

Select settings in the touch panel.

(1) If the multipurpose tray settings are different from the paper to be printed on, tap the [Change] key and go to (2).

If the same, tap the [OK] key.

(2) Tap the [Heavy Paper 1] or [Heavy Paper 2] key.

Tap the [Heavy Paper 1] key if the paper is 28 lbs. bond to 65 lbs. cover (106 g/m² to 176 g/m²), the [Heavy Paper 2] key if the paper is 65 lbs. cover to 80 lbs. cover (177 g/m² to 220 g/m²).

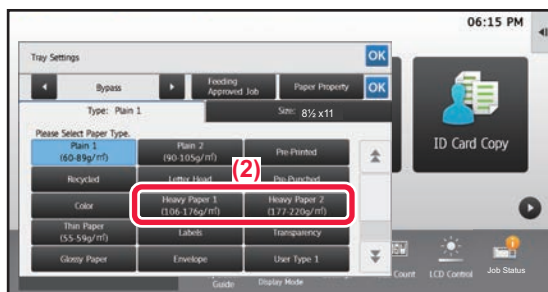

(3) Tap the [Size] tab.

(4) Tap the [8-1/2" x 11] key.

(5) Tap **OK** of "Tray Settings".

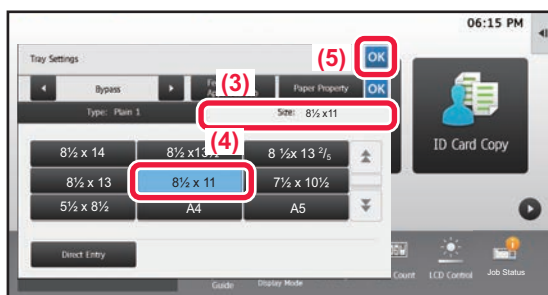



3

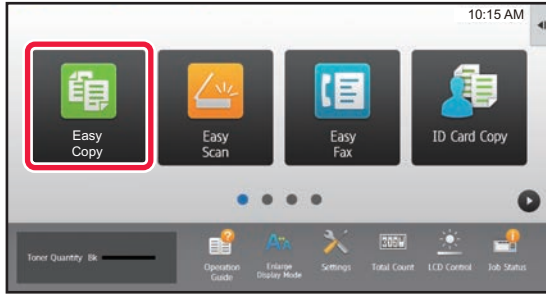

Tap the [Easy Copy] mode icon.

Easy Copy mode screen appears.

4

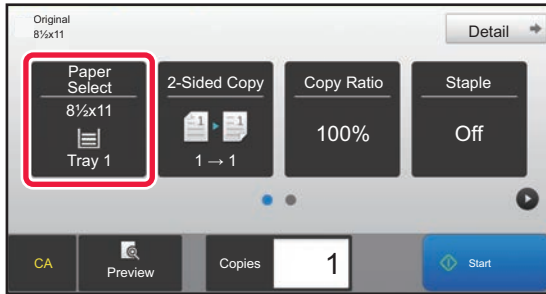

Tap the [Paper Select] Key.

5

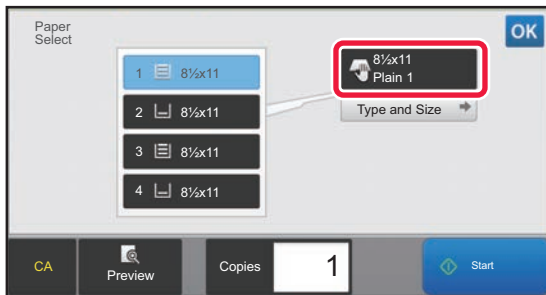

Select the Bypass Tray.

6

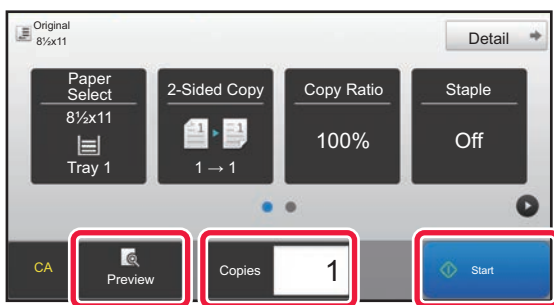

Set the number of copies and then tap the [Start] key.

- To check a preview of a document, tap the [Preview] key.
- ▶ [PREVIEW SCREEN \(page 14\)](#)

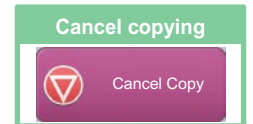
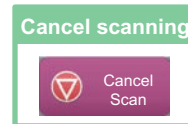



PRINTER

This section explains the basic procedure for printing using the printer driver of the machine. The explanations of screens and procedures are primarily for Windows® 10 in Windows® environments, and Mac OS X v10.12 in Mac OS environments. The window varies depending on the operating system version, the printer driver version, and the application.

▶ PRINTING IN A WINDOWS ENVIRONMENT	34
▶ PRINTING IN A Mac OS ENVIRONMENT	36
▶ DIRECTLY PRINTING A FILE IN USB MEMORY.....	38



PRINTING IN A WINDOWS ENVIRONMENT

The following example explains how to print an A4 size document from "WordPad", which is a standard accessory program in Windows.

To install the printer driver and configure settings in a Windows environment, see the Software Setup Guide.

For information on the available printer drivers and the requirements for their use, see the User's Manual.

1

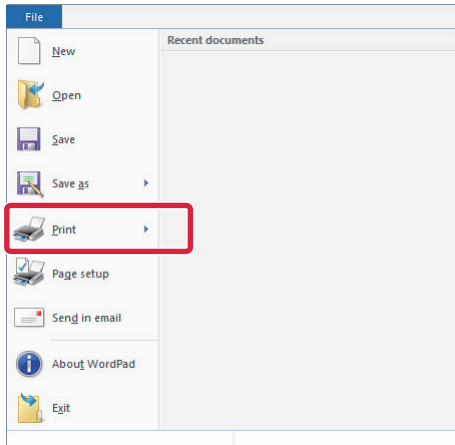

Select [Print] from the [File] menu of WordPad.

2

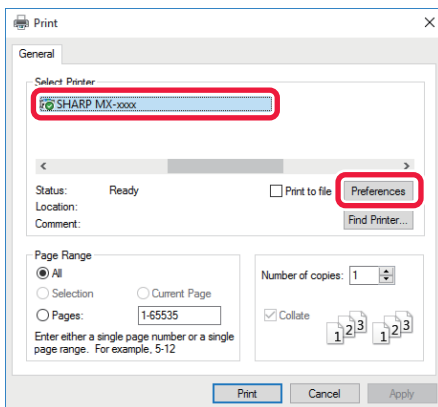

Select the machine's printer driver, and click the [Preferences] button.

If the printer drivers appear as a list, select the name of the printer driver to be used from the list.

3

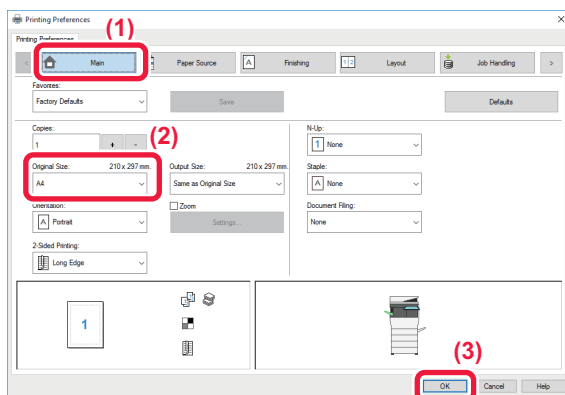

Select print settings.

(1) Click the [Main] tab.

(2) Select the original size.

To select settings on other tabs, click the desired tab and then select the settings.

(3) Click the [OK] button.

- Help can be displayed for a setting by clicking the setting and pressing the [F1] key.
- Click the [Help] button, the Help window will open to let you view explanations of the settings on the tab.



4

Click the [Print] button.

Printing begins.

PRINTING ON ENVELOPES

The bypass tray can be used for envelope printing.

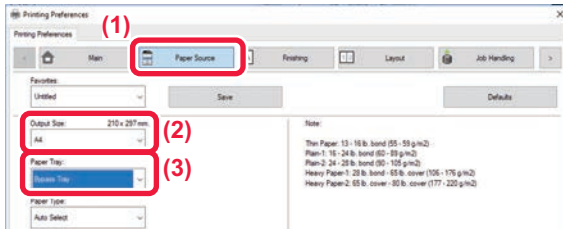

(1) Click the [Paper Source] tab.

(2) Select the envelope size from "Output Size".

When "Output Size" is set to [DL], "Paper Type" is also automatically set to [Envelope].

(3) Select [Bypass Tray] from the "Paper Tray".



Set the paper type of the bypass tray to [Envelope] and load an envelope into the bypass tray.

▶ [Loading envelopes \(page 20\)](#)





PRINTING IN A Mac OS ENVIRONMENT

The following example explains how to print a Letter size document from "TextEdit", which is a standard accessory program in Mac OS.

To install the printer driver and configure settings in a Mac OS environment, see the Software Setup Guide.

1

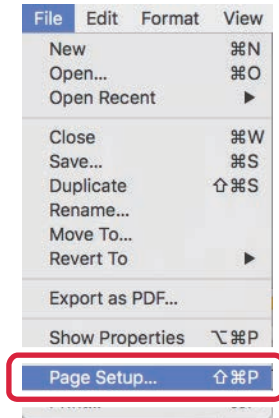

Select [Page Setup] from the [File] menu.

2

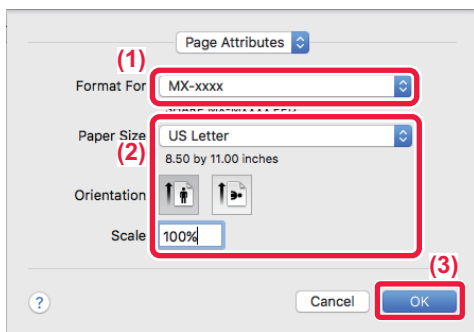

Select paper settings.

- (1) Make sure that the correct printer is selected.
- (2) Select the paper settings.
Set the paper size, paper orientation, and copy ratio.
- (3) Click the [OK] button.

3

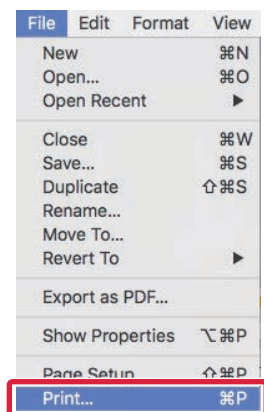

Select [Print] from the [File] menu.



4

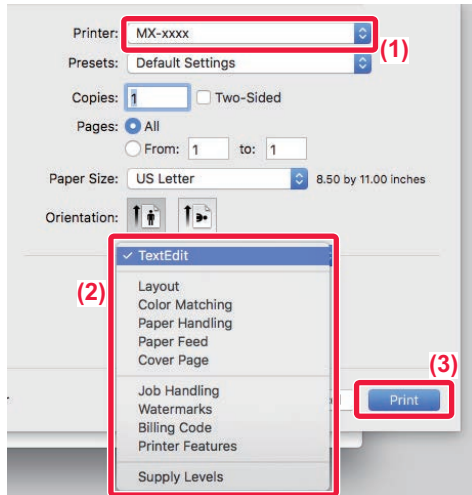

Select print settings.

- (1) Make sure that the correct printer is selected.
- (2) Select items from the menu and configure the settings as needed.
- (3) Click the [Print] button.

PRINTING ON ENVELOPES

The bypass tray can be used for envelope printing.

Select the envelope size in the settings of the application ("Page Setup" in many applications) and then perform the following steps.

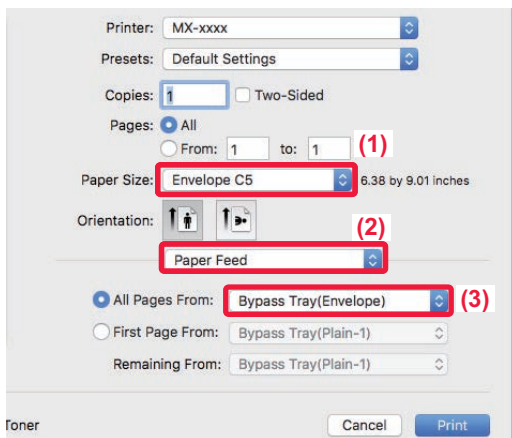

- (1) Select the envelope size from "Paper Size".
- (2) Select [Paper Feed].
- (3) Select [Bypass Tray(Envelope)] from the "All Page From".



Set the paper type of the bypass tray to [Envelope] and load an envelope into the bypass tray.

▶ [Loading envelopes \(page 20\)](#)



DIRECTLY PRINTING A FILE IN USB MEMORY

Files in a USB memory device connected to the machine are printed from the operation panel of the machine without using the printer driver. The file types (and corresponding extensions) that can be printed directly are shown below.

File Type	TIFF	JPEG	PCL	PDF, EncryptedPDF, Compact PDF, PDF/A, Compact PDF/A	PS	DOCX, XLSX, PPTX	PNG
Extension	tiff, tif	jpeg, jpg, jpe, jfif	pcl, prn, txt	pdf	ps, prn	docx, xlsx, pptx	png

1

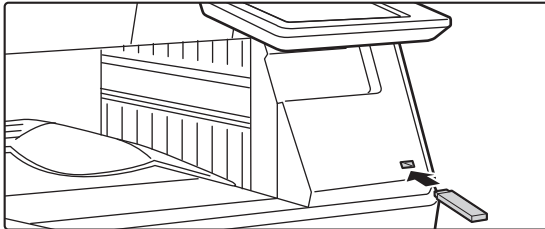

Connect the USB memory device to the machine.

2

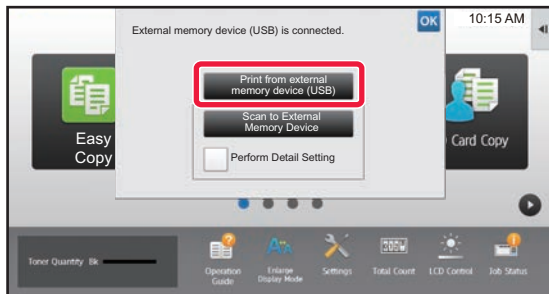

When a screen for selecting the action appears, tap [Print from external memory device (USB)].

If the screen does not appear, follow these steps:

- (1) Tap the [HDD File retrieve] key.
- (2) Tap [Select File from USB Memory to Print] on the action panel.

3

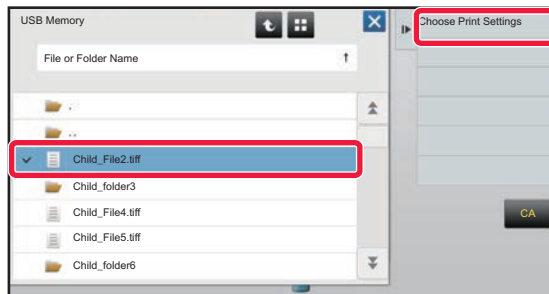

Tap the key of the file that you wish to print, and tap [Choose Print Settings] on the action panel.

- When printing multiple files, tap the keys of the files you wish to print, and tap [Print] on the action panel.
- Tap to switch to thumbnails.

4

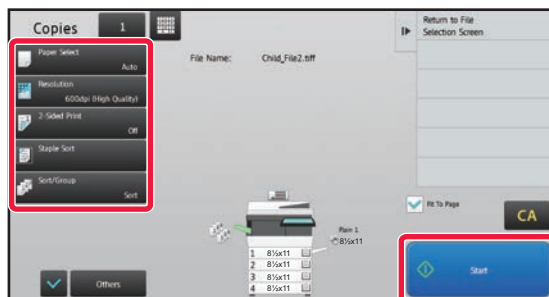

Select print settings and tap the [Start] key.

5

Remove the USB memory device from the machine.

"DirectOffice™ is a product of CSR Imaging US, LP. DirectOffice™ is a trademark of CSR Imaging US, LP, registered in the United States and other countries, used with permission."



FACSIMILE

This section explains the basic procedures for using the fax function of the machine.

▶ SENDING A FAX	40
▶ FAX MODE.....	42



SENDING A FAX

This section explains the basic procedure for sending a fax. In fax mode, color originals are sent as black and white images.

1



Press the [Home Screen] key.

Home screen appears.

2

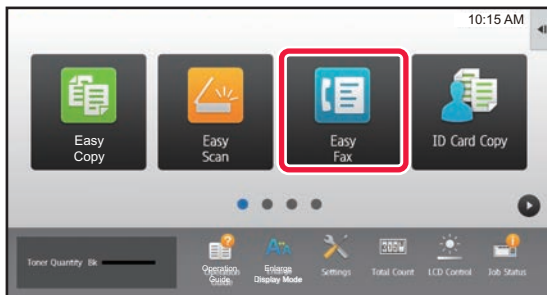

Tap the [Easy Fax] mode icon.

Easy Fax mode screen appears.

3

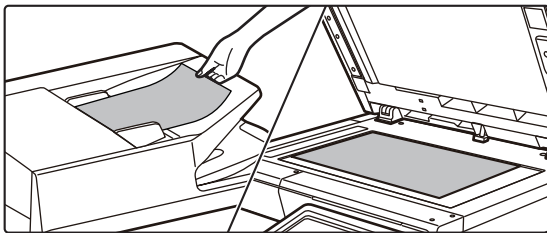

Place the original.

Place the original in the document feeder tray of the automatic document feeder, or on the document glass.

▶ [PLACING ORIGINALS \(page 15\)](#)

4

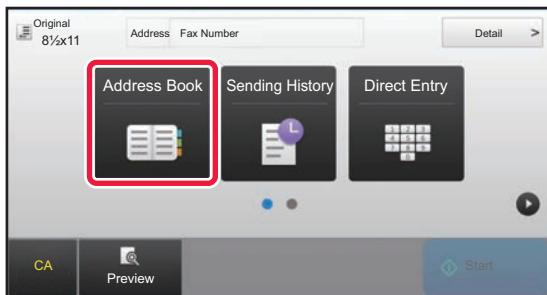

Tap the [Address Book] key.

You can also tap the numeric keys to directly enter a fax number, or select a fax number from the transmission log.

5

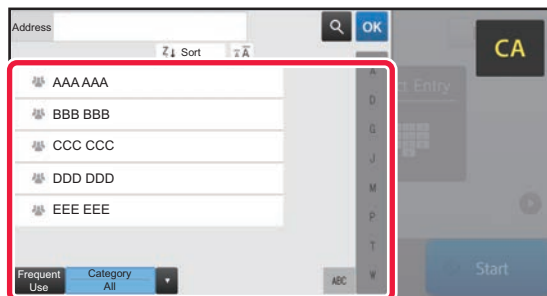

Tap the key of the desired destination.

Addresses of the current mode are selected from addresses whose checkboxes were selected when the tapped destination was registered. If no addresses were registered with the checkbox selected, tap the [Yes] key in the confirmation screen and select the desired addresses.

To add another destination, tap the key of the destination.



6

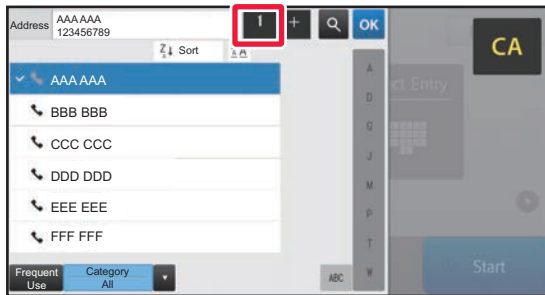

Tap the [All Destinations] key.

A list of the selected destinations appears.

7

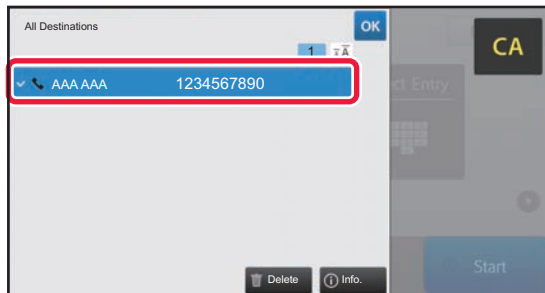

Confirm the destination.

If an incorrect destination appears in the list, tap the destination and then tap the [Delete] key.

8

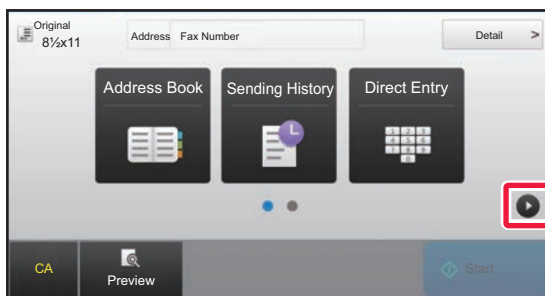

Tap to change screens and select settings.

Change settings as needed.

The functions below can be enabled in easy mode.

- Original set
- Exposure
- Resolution

To select more detailed settings, tap the [Detail] key and select settings in normal mode.

▶ [FAX MODE \(page 42\)](#)

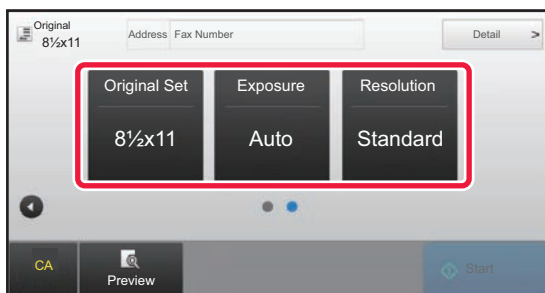

9

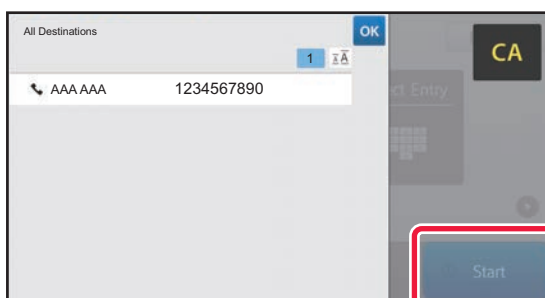

Tap the [Start] key.

To check a preview of a document, tap  to return to the base screen of Easy Fax and tap the [Preview] key.

▶ [PREVIEW SCREEN \(page 14\)](#)

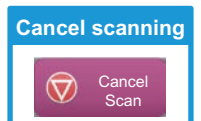



FAX MODE

Fax mode has two modes: easy mode and normal mode.

Easy mode is limited to frequently used functions that allow you to smoothly perform most fax jobs.

If you need to select detailed settings or special functions, use normal mode.

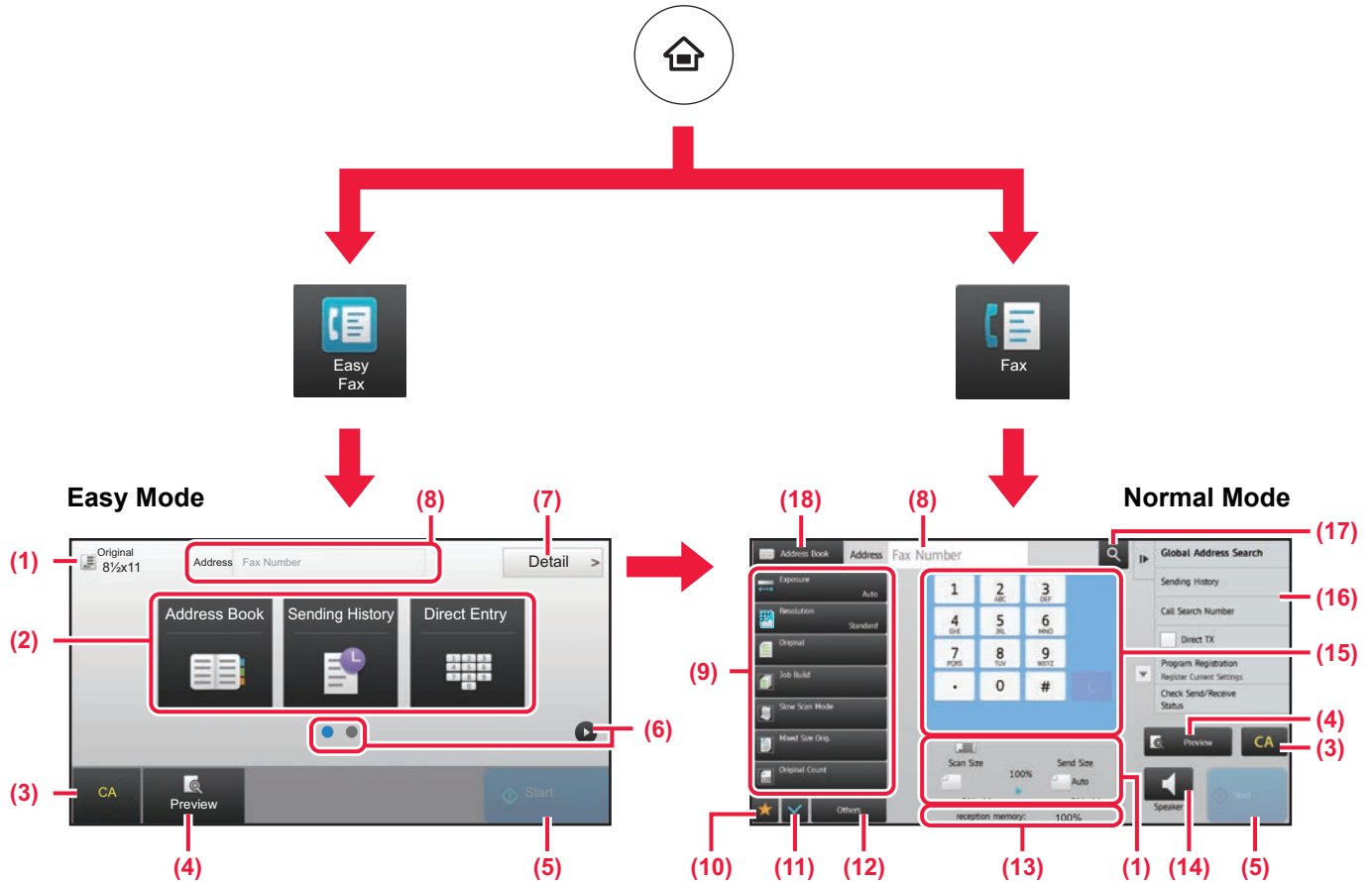

- (1) Displays the sizes of the original and the data to send.
- (2) Select the address and functions you want to use.

To select a function in easy mode
 In "Settings", select [System Settings] → [Common Settings] → [Operation Settings] → [Easy Mode Settings] → [Easy Fax]

- (3) Reset settings and addresses.
- (4) Scan the original and show a preview image.
 ▶ [PREVIEW SCREEN \(page 14\)](#)
- (5) Fax transmission will start immediately.
- (6) Switch the pages for displaying shortcut keys.
- (7) Change to normal mode.
- (8) Shows the destination fax number.
- (9) Setting keys that can be used for the fax.

- (10) Displays the list of function keys. Frequently used [Others] can be registered.
- (11) Check the current settings.
- (12) Displays the list of keys other than the function keys indicated above.
 ▶ [FUNCTIONS THAT CAN BE USED ON THE MACHINE \(page 24\)](#)
- (13) Shows the amount of free memory available for fax reception.
- (14) Tap to dial in speaker mode.
- (15) Enter the fax number.
- (16) Displays the functions that can be utilized in the Fax Mode.
- (17) Searches for the address.
- (18) Displays the address book.



SCANNER

This section explains the uses of the network scanner function and the basic procedure for using scan mode.

The Internet fax expansion kit is required to use the Internet fax function.

▶ NETWORK SCANNER FUNCTION.....	44
▶ SCANNING AN ORIGINAL.....	45
▶ SCANNER MODE	47



NETWORK SCANNER FUNCTION

The network scanner function of the machine can be used to transmit scanned images by a variety of methods. The network scanner function has the following modes. To use a mode, tap the button of the mode in the home screen.

Scan modes



To send an image to an e-mail address, use
Scan to E-mail



To upload an image to an FTP server, use
Scan to FTP



To send an image to a shared folder on your computer, use
Scan to Network Folder

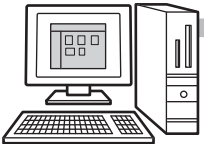

To process an image in a specific application, use
Scan to Desktop



Scan the original, and then...

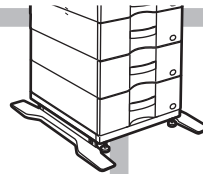

USB memory mode

Use this mode to save an image to USB memory



Internet fax mode

Use this mode to send a fax via the Internet



The machine supports Direct SMTP.

PC scan mode

Use this mode to scan a photo while making corrections on your computer



A TWAIN-compliant software application can be used.

Data entry mode

If you want to use a document solution linked to an application





SCANNING AN ORIGINAL

The basic operation for scanning is explained below.

The procedure for sending a scanned file by E-mail to a destination stored in the address book is explained here.

1



Press the [Home Screen] key.

Home screen appears.

2

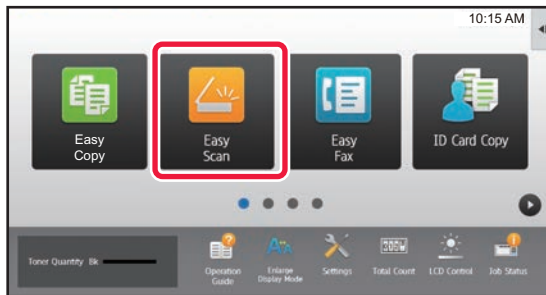

Tap the [Easy Scan] mode icon.

Easy Scan mode screen appears.

3

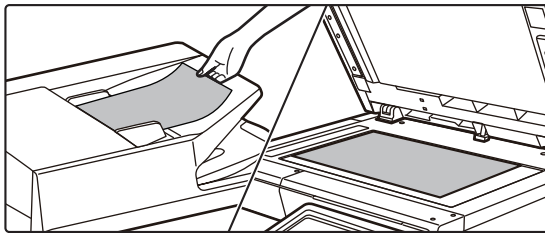

Place the original.

Place the original in the document feeder tray of the automatic document feeder, or on the document glass.

▶ [PLACING ORIGINALS \(page 15\)](#)

4

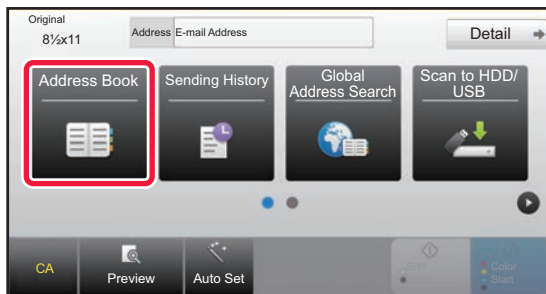

Tap the [Address Book] key.

5

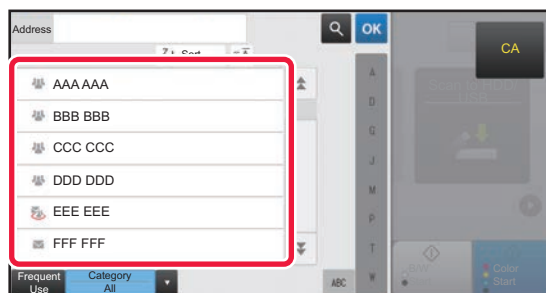

Tap the key of the desired destination.

Addresses of the current mode are selected from addresses whose checkboxes were selected when the tapped destination was registered. If no addresses were registered with the checkbox selected, tap the [Yes] key in the confirmation screen and select the desired addresses.

To add another destination, tap the key of the destination.





6

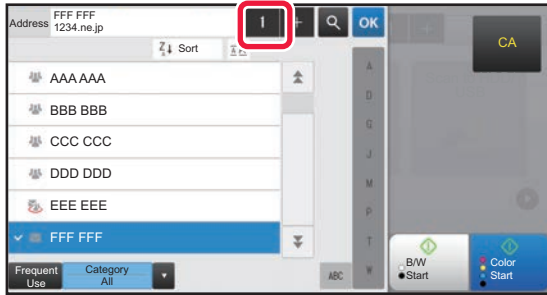

Tap the [All Destinations] key.

A list of the selected destinations appears.

7

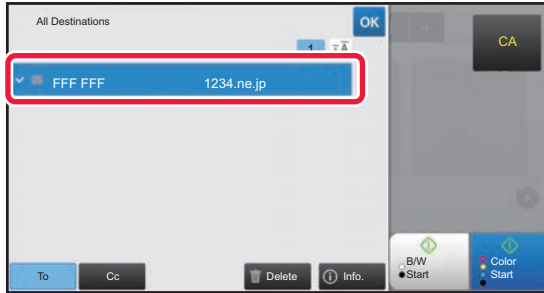

Confirm the destination.

If an incorrect destination appears in the list, tap the destination and then tap the [Delete] key.

8

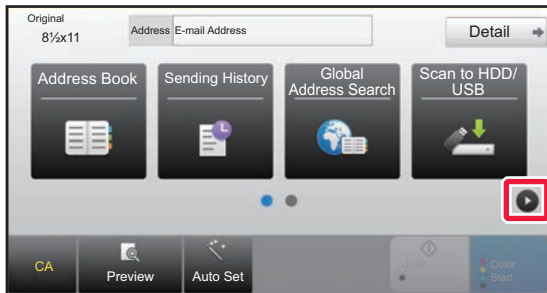

Tap to change screens and select settings.

Change settings as needed.

The functions below can be enabled in easy mode.

- Original
- Resolution
- File Format
- Blank Page Skip

To select more detailed settings, tap the [Detail] key and select settings in normal mode.

▶ [SCANNER MODE \(page 47\)](#)

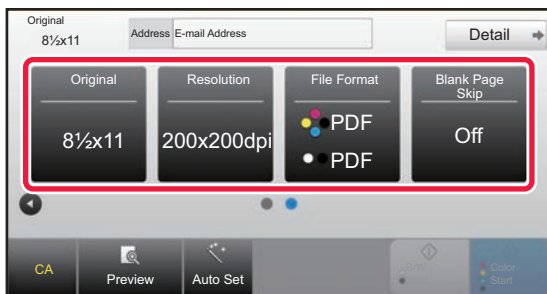



9

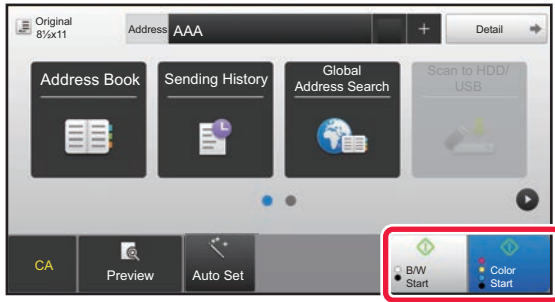

Tap the [Color Start] key or [B/W Start] key.

- In the factory default state, the machine detects whether the original is black & white or full color when you tap the [Color Start] key, and automatically switches between full color and black & white binary scanning. When you tap the [B/W Start] key, the machine scans in black & white binary. For details, see the User's Manual.
- To check a preview of a document, tap **OK** to return to the base screen of Easy Scan and tap the [Preview] key.
 - ▶ [PREVIEW SCREEN \(page 14\)](#)

Cancel scanning



SCANNER MODE

SELECTING SCANNER MODE

In the home screen, tap the icon of the desired scanner mode to display the base screen of scanner mode. If the button you want to use does not appear, tap **◀** or **▶** to change the screen.

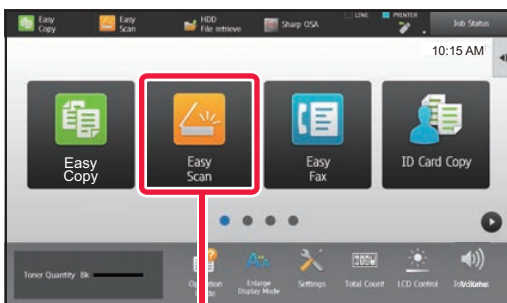

Easy
Scan

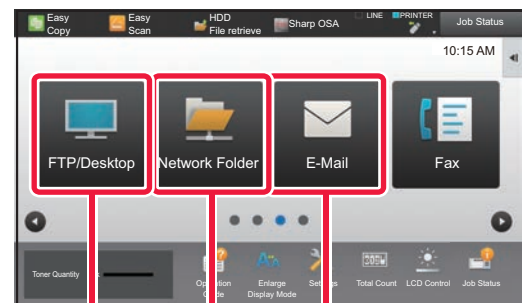
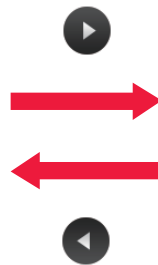

Scan to
FTP/Desktop

Scan to
Network
Folder

Scan to
E-mail





BASE SCREEN OF SCANNER MODE

Scanner mode has two modes: easy mode and normal mode.

Easy mode is limited to frequently used functions that allow you to smoothly perform most scan jobs.

If you need to select detailed settings or special functions, use normal mode.

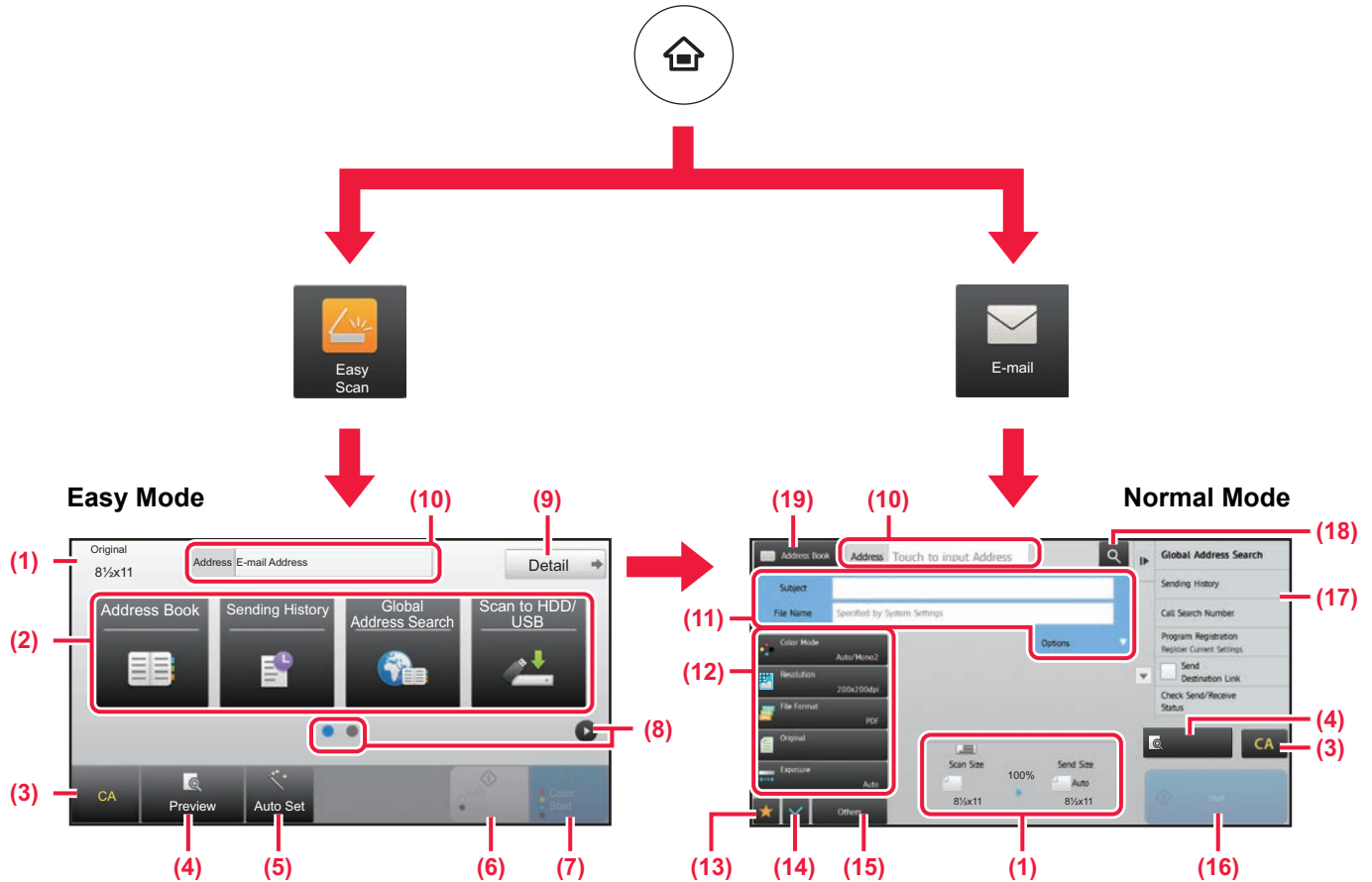

- (1) Displays the sizes of the original and the data to send.
- (2) Select the address and functions you want to use.

To select a function in easy mode
 In "Settings", select [System Settings] → [Common Settings] → [Operation Settings] → [Easy Mode Settings] → [Easy Scan]

- (3) Reset settings and addresses.
- (4) Scan the original and show a preview image.
 ▶ [PREVIEW SCREEN \(page 14\)](#)
- (5) Automatically set the original placement orientation, resolution, and skipping of blank pages.
- (6) Starts blank & white scanning.
- (7) Starts color scanning.
- (8) Switch the pages for displaying shortcut keys.
- (9) Change to normal mode.
- (10) Tap this key to display the soft keyboard.

- (11) Enter the subject, file name, and other items. The screen varies depending on the scanning type.
- (12) Setting keys that can be used for sending images.
- (13) Displays the list of function keys. Frequently used [Others] can be registered.
- (14) Checking the current settings.
- (15) Displays the list of keys other than the function keys indicated above.
 ▶ [FUNCTIONS THAT CAN BE USED ON THE MACHINE \(page 24\)](#)
- (16) Transmission will start.
- (17) Displays the functions that can be utilized in the Image Send mode.
- (18) Searches for the address.
- (19) Displays the address book.



DOCUMENT FILING

The document filing function is used to store the document or print image on the hard drive when performing a copy, print, or other job. You can print or perform other operations using the saved file at a later time.

This section introduces several of the document filing functions.

▶ USES OF THE DOCUMENT FILING FUNCTION	50
▶ SAVING A DOCUMENT ONLY (Scan to HDD)	51
▶ PRINTING A SAVED FILE.....	54



USES OF THE DOCUMENT FILING FUNCTION

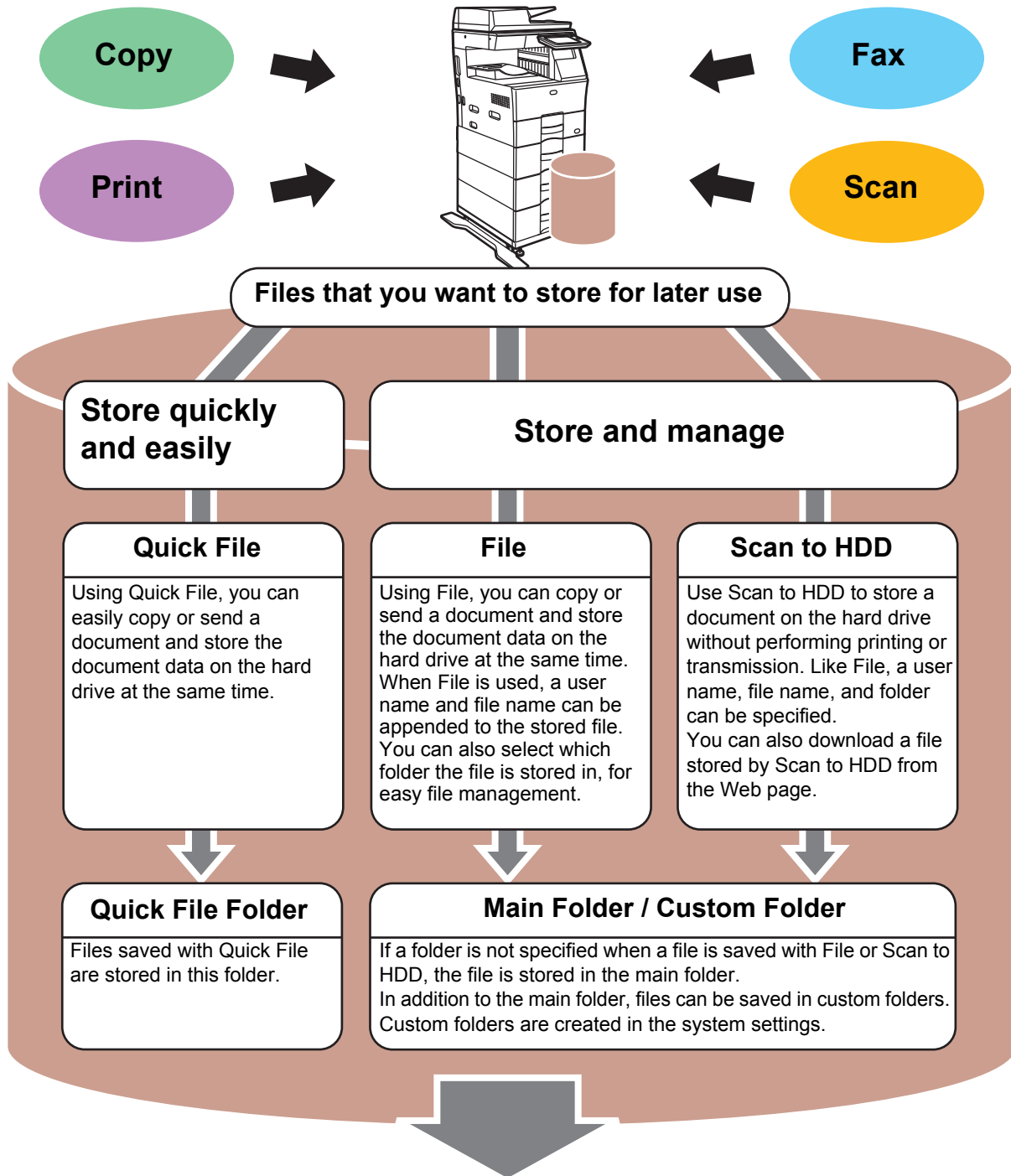

**Stored files can be printed or transmitted whenever needed.
 A file that has been stored by the printer driver cannot be transmitted.
 (The file can be transmitted if "RIP format" is changed to "RGB" format.)**



SAVING A DOCUMENT ONLY (Scan to HDD)

Scan to HDD lets you save a scanned document to the main folder or a custom folder. This function is not used to print or send.

The procedure for storing a document in the main folder is explained below.

To save to a custom folder, tap the [HDD File retrieve] key in the Home screen, tap [Scan to HDD] on the action panel, and select save settings. For more information, see the User's Manual.

Saving by Easy Scan

You can save a file in the main folder or My Folder (when user authentication is enabled).

1



Press the [Home Screen] key.

The Home screen appears.

2

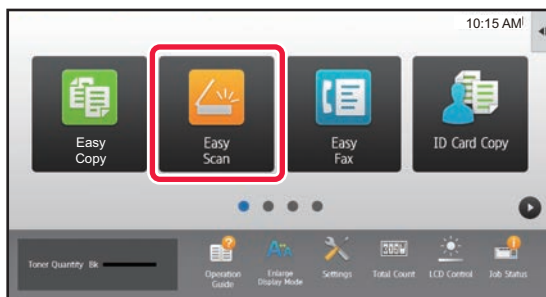

Tap the [Easy Scan] mode icon.

3

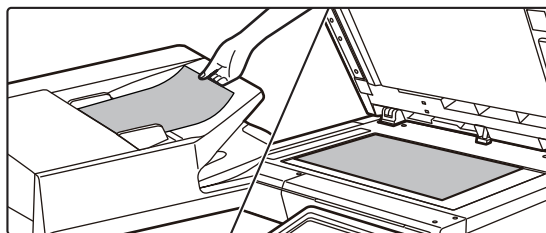

Place the original.

Place the original in the document feeder tray of the automatic document feeder, or on the document glass.

► [PLACING ORIGINALS \(page 15\)](#)

4

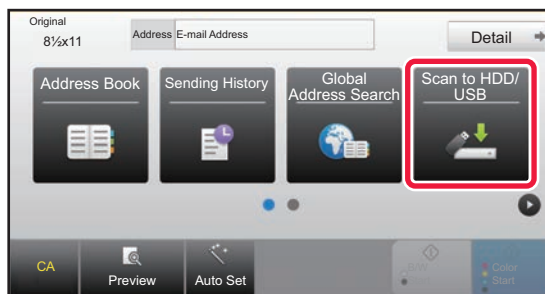

Tap the [Scan to HDD/ USB] key.





5

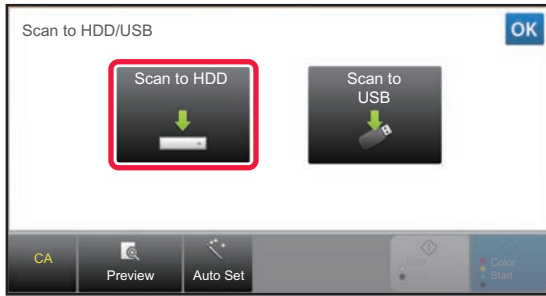

Tap the [Scan to HDD] key.

6

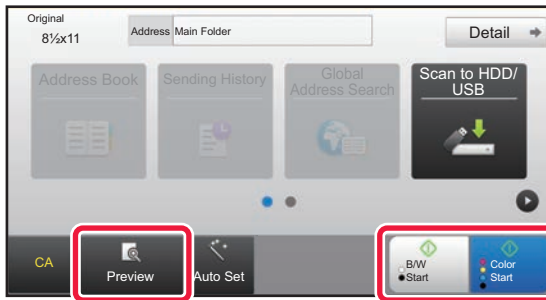

Tap the [Color Start] key or [B/W Start] key.

To check a preview of a document, tap the [Preview] key.

▶ [PREVIEW SCREEN \(page 14\)](#)

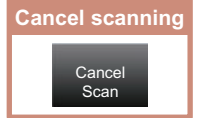



Scan to USB memory device

1

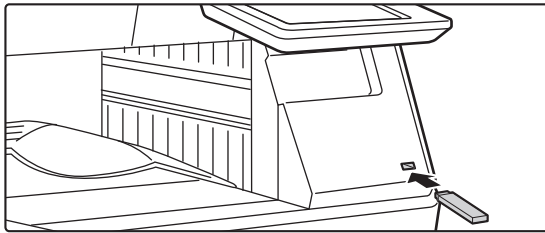

Connect the USB memory device to the machine.

2

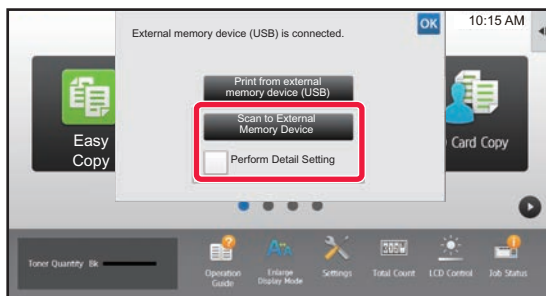

When a screen for selecting the action appears, tap [Scan to External Memory Device].

- To select detailed settings in normal mode, select the [Perform Detail Setting] checkbox .
- ▶ [BASE SCREEN OF SCANNER MODE \(page 48\)](#)
- If the machine/device save screen is open, this screen will not appear.

3

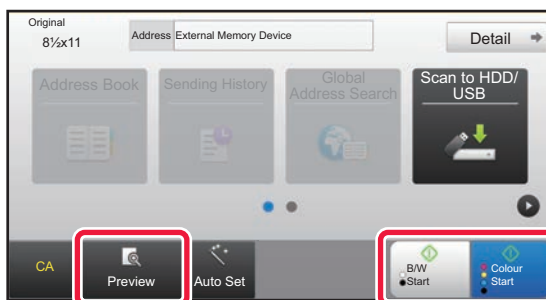

Tap the [Color Start] key or [B/W Start] key.

To check a preview of a document, tap the [Preview] key.

- ▶ [PREVIEW SCREEN \(page 14\)](#)

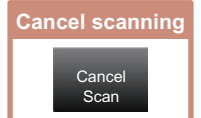

4

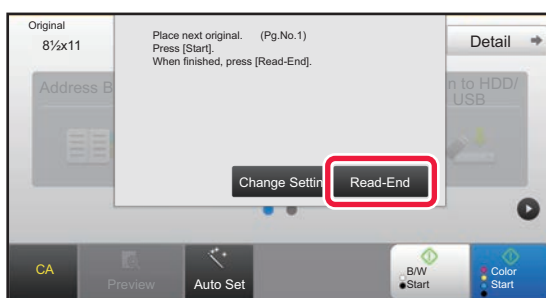

After scanning all originals, tap the [Read-End] key.

When you scan the original using the automatic document feeder, this screen does not appear.

5

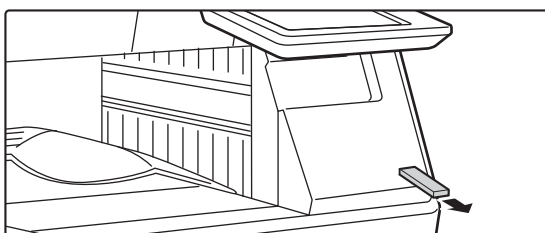

Check the [Sending data has been completed.] message, and remove the USB memory device from the machine.





PRINTING A SAVED FILE

You can retrieve a file stored by document filing and print or transmit the file. You can also print files saved in a USB memory device or a shared folder. The steps for printing the "Copy_08082017_112030" file saved in the main folder are explained below.

1



Press the [Home Screen] key.
Home screen appears.

2

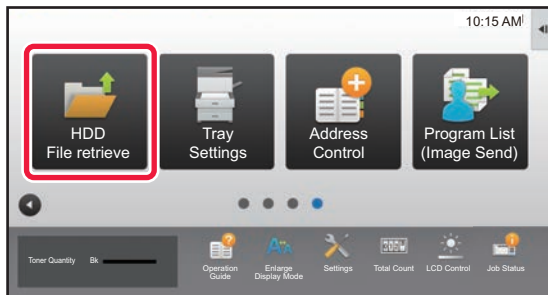

Tap the [HDD File retrieve] mode icon.

3

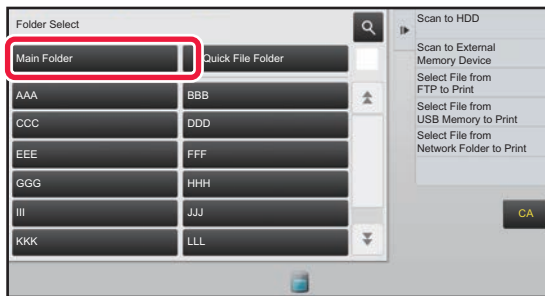

Select the file and print.
(1) Tap the [Main Folder] key.

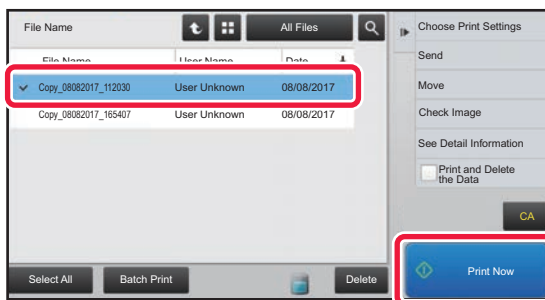

(2) Tap the key of the file that you wish to print.
In this case, tap the "Copy_08082017_112030" key. To check a preview of the printed image, tap [Check Image] on the action panel. If you want to delete the file after printing, tap [Print and Delete the Data] on the action panel so that appears.
(3) Tap the [Print Now] key.



SYSTEM SETTINGS

The setting mode let you adjust the operation of the machine to suit the needs of your workplace. This section briefly introduces several of the setting mode. For detailed explanations of the system settings, see "SYSTEM SETTINGS" in the User's Manual.

▶ SETTING MODE	56
----------------------	----



SETTING MODE

The date and time can be set, fax and scan destinations can be stored, document filing folders can be created, and various other settings related to the operation of the machine can be configured in the setting mode screen. The procedure for opening the setting mode screen and the items in the screen are explained below.

DISPLAYING THE SETTING MODE ON THE MACHINE

1



Press the [Home Screen] key.

Home screen appears.

2

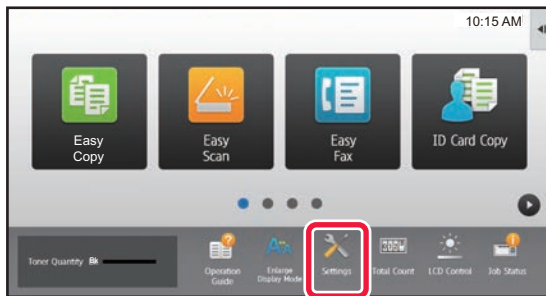

Tap the [Settings] key.

The setting mode screen appears.

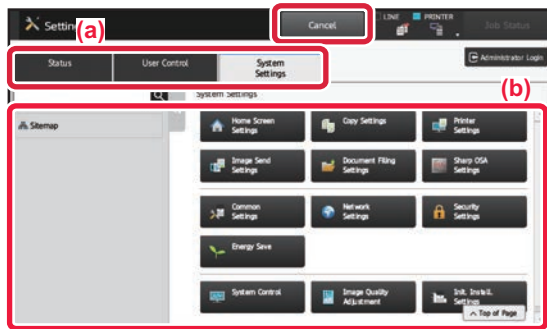

Tap the item that you want to set on menu tab (a) or setting menu (b).

To exit setting mode, tap the [Cancel] key.

▶ [Setting mode when an administrator is logged in \(page 58\)](#)



WHAT YOU CAN DO IN THE SETTING MODE

The following settings can be configured in setting mode.

Some settings may not appear on the touch panel of the machine, or in the Web browser on your computer. Some settings may not appear due to the specifications of your machine and the peripheral devices that are installed.

Menu	Overview	
Status	Displays paper tray information and device information.	
Address Book	Use to edit the address book.	
Document Operations	Use to perform actions on a file using the Document Filing function.	
User Control	This is used to store, edit, and delete users when user authentication is enabled. You can also select IC card settings.	
System Settings	Configure the main settings for the machine such as date settings and paper tray settings. You can configure the following settings.	
	Home Screen Settings	You can select settings for the machine's home screen, such as changing the home screen background.
	Copy Settings	You can select copy settings.
	Printer Settings	You can select print settings.
	Image Send Settings	Configure settings for image send, such as fax and Scan to E-mail.
	Document Filing Settings	You can select Document Filing settings.
	Sharp OSA Settings	You can select SharpOSA settings.
	Common Settings	You can configure machine settings such as date settings and tray settings.
	Network Settings	You can configure network settings such as network protocol and NAS settings.
	Security Settings	You can configure machine security settings such as authentication and changing the administrator password.
	Energy Save	The machine's power consumption can be reduced by Eco Mode setting.
	System Control	You can configure machine backup and job log settings.
	Image Quality Adjustment	You can perform image adjustment on the machine.
Initial Installation Settings	This is a group of settings that are required when you initially install the machine.	





Setting mode when an administrator is logged in

An administrator can configure settings that are more advanced than the settings available to a guest or user. When user authentication is enabled, settings may be allowed without entering the administrator password based on the rights of the logged in user. For the state of the settings, ask the administrator of the machine.

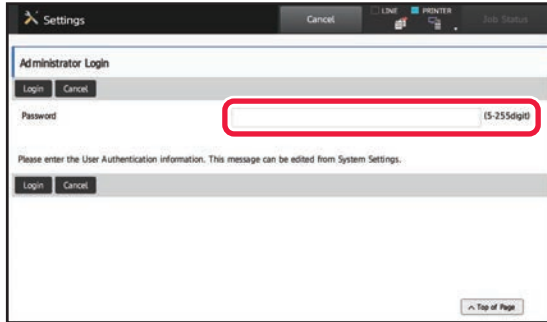

When you select an item in setting mode that requires administrator login, the administrator login screen will appear.

For the items available in setting mode when an administrator is logged in, see "SYSTEM SETTINGS" in the User's Manual.

Please note

- For information on your operating system, please refer to your operating system manual or the online Help function.
- The explanations of screens and procedures in a Windows environment are primarily for Windows 10®. The screens may vary depending on the version of the operating system or the software application.
- The explanations of screens and procedures in a Mac OS environment are based on Mac OS X v10.12 in the case of Mac OS X. The screens may vary depending on the version of the operating system or the software application.
- Wherever "MX-xxxx" appears in this manual, please substitute your model name for "xxxx".
- Considerable care has been taken in preparing this manual. If you have any comments or concerns about the manual, please contact your dealer or nearest SHARP Service Department.
- This product has undergone strict quality control and inspection procedures. In the unlikely event that a defect or other problem is discovered, please contact your dealer or nearest SHARP Service Department.
- Aside from instances provided for by law, SHARP is not responsible for failures occurring during the use of the product or its options, or failures due to incorrect operation of the product and its options, or other failures, or for any damage that occurs due to use of the product.

Warning

- Reproduction, adaptation or translation of the contents of the manual without prior written permission is prohibited, except as allowed under copyright laws.
- All information in this manual is subject to change without notice.

Illustrations and the operation panel and touch panel shown in this manual

The peripheral devices are generally optional, however, some models include certain peripheral devices as standard equipment.

The explanations in this manual assume that a paper drawer is installed on the MX-B455W.

For some functions and procedures, the explanations assume that devices other than the above are installed.

<p>The display screens, messages, and key names shown in the manual may differ from those on the actual machine due to product improvements and modifications.</p>
--

SHARP[®]
SHARP CORPORATION