

SHARP

PN-L862B

PN-L752B

PN-L652B

LCD MONITOR

OPERATION MANUAL

HDMI™

IMPORTANT:

To aid reporting in case of loss or theft, please record the product's model and serial numbers in the space provided. The numbers are located in the rear of the product.



Model No.:

Serial No.:

U.S.A. ONLY

IMPORTANT INFORMATION

WARNING: TO REDUCE THE RISK OF FIRE OR ELECTRIC SHOCK, DO NOT EXPOSE THIS PRODUCT TO RAIN OR MOISTURE.

	CAUTION RISK OF ELECTRIC SHOCK DO NOT OPEN	
<p>CAUTION: TO REDUCE THE RISK OF ELECTRIC SHOCK, DO NOT REMOVE COVER. NO USER-SERVICEABLE PARTS INSIDE. REFER SERVICING TO QUALIFIED SERVICE PERSONNEL.</p>		



The lightning flash with arrowhead symbol, within a triangle, is intended to alert the user to the presence of uninsulated “dangerous voltage” within the product’s enclosure that may be of sufficient magnitude to constitute a risk of electric shock to persons.



The exclamation point within a triangle is intended to alert the user to the presence of important operating and maintenance (servicing) instructions in the literature accompanying the product.

WARNING:

FCC Regulations state that any unauthorized changes or modifications to this equipment not expressly approved by the manufacturer could void the user’s authority to operate this equipment.

NOTE:

This equipment has been tested and found to comply with the limits for a Class A digital device, pursuant to Part 15 of the FCC Rules. These limits are designed to provide reasonable protection against harmful interference when the equipment is operated in a commercial environment. This equipment generates, uses, and can radiate radio frequency energy and, if not installed and used in accordance with the instruction manual, may cause harmful interference to radio communications. Operation of this equipment in a residential area is likely to cause harmful interference in which case the user will be required to correct the interference at his own expense.

U.S.A. ONLY

To maintain compliance with EMC regulations, use shielded cables to connect to the following terminals: HDMI input terminal, D-sub input terminal, RS-232C input terminal, USB Type C port, TOUCH PANEL terminal, and USB port.

DEAR SHARP CUSTOMER

Thank you for your purchase of a SHARP LCD product. To ensure safety and many years of trouble-free operation of your product, please read the Safety Precautions carefully before using this product.

SAFETY PRECAUTIONS

Electricity is used to perform many useful functions, but it can also cause personal injuries and property damage if improperly handled. This product has been engineered and manufactured with the highest priority on safety. However, improper use can result in electric shock and/or fire. In order to prevent potential danger, please observe the following instructions when installing, operating and cleaning the product. To ensure your safety and prolong the service life of your LCD product, please read the following precautions carefully before using the product.

1. Read instructions — All operating instructions must be read and understood before the product is operated.
2. Keep this manual in a safe place — These safety and operating instructions must be kept in a safe place for future reference.
3. Observe warnings — All warnings on the product and in the instructions must be observed closely.
4. Follow instructions — All operating instructions must be followed.
5. Cleaning — Unplug the power cord from the power outlet before cleaning the product. Use a dry cloth to clean the product. Do not use liquid cleaners or aerosol cleaners. Do not use dirty cloths. Doing so may damage the product.
6. Attachments — Do not use attachments not recommended by the manufacturer. Use of inadequate attachments can result in accidents.
7. Water and moisture — Do not use the product near water. Do not install the product in a place where water may splash onto it. Be careful of equipment which drains water such as an air-conditioner.
8. Ventilation — The vents and other openings in the cabinet are designed for ventilation. Do not cover or block these vents and openings since insufficient ventilation can cause overheating and/or shorten the life of the product. Do not place the product on a sofa, rug or other similar surface, since they can block ventilation openings. Do not place the product in an enclosed place such as a bookcase or rack, unless proper ventilation is provided or the manufacturer's instructions are followed.
9. Power cord protection — The power cords must be routed properly to prevent people from stepping on them or objects from resting on them.
10. The screen used in this product is made of glass. Therefore, it can break when the product is dropped or applied with impact. Be careful not to be injured by broken glass pieces in case the screen breaks.
11. Overloading — Do not overload power outlets or extension cords. Overloading can cause fire or electric shock.
12. Entering of objects and liquids — Never insert an object into the product through vents or openings. High voltage flows in the product, and inserting an object can cause electric shock and/or short internal parts. For the same reason, do not spill water or liquid on the product.
13. Servicing — Do not attempt to service the product yourself. Removing covers can expose you to high voltage and other dangerous conditions. Request a qualified service person to perform servicing.
14. Repair — If any of the following conditions occurs, unplug the power cord from the power outlet, and request a qualified service person to perform repairs.
 - a. When the power cord or plug is damaged.
 - b. When a liquid was spilled on the product or when objects have fallen into the product.
 - c. When the product has been exposed to rain or water.
 - d. When the product does not operate properly as described in the operating instructions.

Do not touch the controls other than those described in the operating instructions. Improper adjustment of controls not described in the instructions can cause damage, which often requires extensive adjustment work by a qualified technician.
 - e. When the product has been dropped or damaged.
 - f. When the product displays an abnormal condition. Any noticeable abnormality in the product indicates that the product needs servicing.
15. Replacement parts — In case the product needs replacement parts, make sure that the service person uses replacement parts specified by the manufacturer, or those with the same characteristics and performance as the original parts. Use of unauthorized parts can result in fire, electric shock and/or other danger.
16. Safety checks — Upon completion of service or repair work, request the service technician to perform safety checks to ensure that the product is in proper operating condition.
17. Wall mounting — When mounting the product on a wall, be sure to install the product according to the method recommended by the manufacturer.
18. Heat sources — Keep the product away from heat sources such as radiators, heaters, stoves and other heat-generating products (including amplifiers).

SAFETY PRECAUTIONS (Continued)

19. Batteries — Incorrect use of batteries may cause the batteries to burst or ignite. A leaky battery may corrode the equipment, dirty your hands or spoil your clothing. In order to avoid these problems, make sure to observe the precautions below:
 - Use the specified batteries only.
 - Install the batteries with due attention to the plus (+) and minus (-) sides of the batteries according to the instructions in the compartment.
 - Do not mix old and new batteries.
 - Do not mix batteries of different types. Voltage specifications of batteries of the same shape may vary.
 - Replace an exhausted battery with a new one promptly.
 - If you will not use the remote control for a long time, remove the batteries.
 - If leaked battery fluid gets on your skin or clothing, rinse immediately and thoroughly. If it gets into your eye, bathe your eye well rather than rubbing and seek medical treatment immediately. Leaked battery fluid that gets into your eye or your clothing may cause a skin irritation or damage your eye.
20. Usage of the monitor must not be accompanied by fatal risks or dangers that, could lead directly to death, personal injury, severe physical damage or other loss, including nuclear reaction control in nuclear facility, medical life support system, and missile launch control in a weapon system.
21. Do not stay in contact with the parts of the product that become hot for long periods of time. Doing so may result in low-temperature burns.
22. Do not modify this product.

WARNING:

This is a Class A product. In a domestic environment this product may cause radio interference in which case the user may be required to take adequate measures.

An apparatus with CLASS I construction shall be connected to a MAIN socket outlet with a protective earthing connection.

STABILITY HAZARD

If a monitor is not positioned in a sufficiently stable location, it can be potentially hazardous due to falling. Many injuries, particularly to children, can be avoided by taking simple precautions such as:

- Using fixing devices like wall mount brackets recommended by the manufacturer.
- Only using furniture that can safely support the monitor.
- Ensuring the monitor is not overhanging the edge of the supporting furniture.
- Not placing the monitor on tall furniture (for example, cupboards or bookcases) without anchoring both the furniture and the monitor to a suitable support.
- Not standing the monitors on cloth or other materials placed between the monitor and supporting furniture.
- Educating children about the dangers of climbing on furniture to reach the monitor or its controls.
- This equipment is not suitable for use in locations where children are likely to be present unsupervised.

Especially for child safety

- Don't allow children to climb on or play with the monitor.
- Don't place the monitor on furniture that can easily be used as steps, such as a chest of drawers.
- Remember that children can become excited while watching a program, especially on a "larger than life" monitor. Care should be taken to place or install the monitor where it cannot be pushed, pulled over, or knocked down.
- Care should be taken to route all cords and cables connected to the monitor so that they cannot be pulled or grabbed by curious children.

TIPS AND SAFETY INSTRUCTIONS

- The TFT color LCD panel used in this monitor is made with the application of high precision technology. However, there may be minute points on the screen where pixels never light or are permanently lit. Also, if the screen is viewed from an acute angle there may be uneven colors or brightness. Please note that these are not malfunctions but common phenomena of LCDs and will not affect the performance of the monitor.
- Do not display a still picture for a long period, as this could cause a residual image.
- Never rub or tap the monitor with hard objects.
- Please understand that SHARP CORPORATION bears no responsibility for errors made during use by the customer or a third party, nor for any other malfunctions or damage to this product arising during use, except where indemnity liability is recognized under law.
- This monitor and its accessories may be upgraded without advance notice.
- Do not use the monitor where there is a lot of dust, where humidity is high, or where the monitor may come into contact with oil or steam. Do not use in an environment where there are corrosive gases (sulfur dioxide, hydrogen sulfide, nitrogen dioxide, chlorine, ammonia, ozone, etc.). As this could lead to fire.
- Ensure that the monitor does not come into contact with water or other fluids. Ensure that no objects such as paper clips or pins enter the monitor as this could lead to fire or electric shock.
- Do not place the monitor on top of unstable objects or in unsafe places. Do not allow the monitor to receive strong shocks or to strongly vibrate. Causing the monitor to fall or topple over may damage it.
- Do not use the monitor near heating equipment or in places where there is likelihood of high temperature, as this may lead to generation of excessive heat and outbreak of fire.
- Do not use the monitor in places where it may be exposed to direct sunlight. Risk of cabinet deformation and failure if the monitor is used in direct sunlight.
- Please be sure to constantly remove dust and garbage that has attached to the ventilation opening. If dust collects in the ventilation opening or the inside of the monitor, it may lead to excessive heat, outbreak of fire, or malfunction. Please request a cleaning of the inside of the monitor from an authorized SHARP servicing dealer or service center.
- The power outlet shall be installed near the equipment and shall be easily accessible.
- Continuous operating time and warranty.
This product is designed for a maximum daily use of 16 hours. Continual use in excess of 16 hours per day is not covered by the warranty.
- Do not touch the screen when turning on the monitor, it will lead to a malfunction. When this occurs, turn the monitor power off and then on.
- Do not operate the screen with a hard or pointed object such as a fingernail or pencil.
- Depending on the application used, the touch pen may not function.
- If another USB device is connected to the computer to which the touch panel is connected, do not operate the USB device during touch panel input. Input may not take place correctly.
- Restarting the Android system.
To maintain stable operation of APPLICATION mode, the Android system must be restarted once a day.
If "Power Save Mode" is on, turn off the power.
If "Power Save Mode" is off, turn off the main power.
- If you or a third party uses the product incorrectly, or if the product is subjected to the effects of static electricity or electrical noise, or if the product malfunctions or is repaired, there is a risk that saved data will be corrupted or lost.

- Always back up important data to a USB flash drive.
- We bear no responsibility for protection of internal memory recorded content or related damages.

The Power Cord

- Use only the power cord supplied with the monitor.
- Do not damage the power cord nor place heavy objects on it, stretch it or over bend it. Also, do not add extension cords. Damage to the cord may result in fire or electric shock.
- Do not use the power cord with a power tap. Adding an extension cord may lead to fire as a result of overheating.
- Do not remove or insert the power plug with wet hands. Doing so could result in electric shock.
- Unplug the power cord if it is not used for a long time.
- Do not attempt to repair the power cord if it is broken or malfunctioning. Refer the servicing to the service representative.

Network

- When you use a network, your communication data is exposed to the risks of being stolen or illegally accessed. To avoid these risks, you need to use this monitor in a secure network environment.

Manual Scope

- Microsoft and Windows are either registered trademarks or trademarks of Microsoft Corporation in the United States and/or other countries.
- Apple, Mac and macOS are trademarks of Apple Inc., registered in the U.S. and other countries.
- The terms HDMI, HDMI High-Definition Multimedia Interface, and the HDMI Logo are trademarks or registered trademarks of HDMI Licensing Administrator, Inc.
- DisplayPort is a registered trademark of Video Electronics Standards Association.
- Google, Chrome OS and Android are trademarks or registered trademarks of Google LLC.
- Ethernet is a registered trademark of Xerox Corporation.
- VESA is either registered trademark or trademark of Video Electronics Standards Association in the United States and/or other countries.
- Bluetooth is a registered trademark of Bluetooth SIG, Inc.
- Arm and Cortex are registered trademarks of Arm Limited (or its subsidiaries) in the US and/or elsewhere.
- All other brand and product names are trademarks or registered trademarks of their respective holders.
- Illustrations in this manual may not exactly represent the actual product or display.

LED Backlight

- The LED backlight in this product has a limited lifetime.
 - * If the screen gets dark or does not turn on, it may be necessary to replace the LED backlight.
 - * This LED backlight is exclusive to this product and must be replaced by an authorized SHARP servicing dealer or service center. Please contact an authorized SHARP servicing dealer or service center for assistance.

MOUNTING PRECAUTIONS

- This product is for use indoors.
- A mounting bracket compliant with VESA specifications is required.
- Since the monitor is heavy, consult your dealer before installing, removing or moving the monitor.
- Mounting the monitor on the wall requires special expertise and the work must be performed by an authorized SHARP dealer. You should never attempt to perform any of this work yourself. Our company will bear no responsibility for accidents or injuries caused by improper mounting or mishandling.
- Use the monitor with the surface perpendicular to a level surface. If necessary, the monitor may be tilted up to 5 degrees upward.
- When moving the monitor, be sure to hold the areas shown in the figure below. Do not grasp the screen. This may cause product damage, failure, or injury.

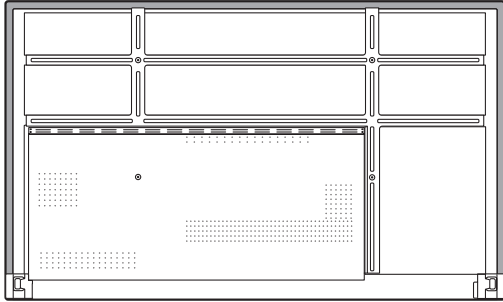

- This monitor should be used at an ambient temperature between 41°F (5°C) and 95°F (35°C). Provide enough space around the monitor to prevent heat from accumulating inside.

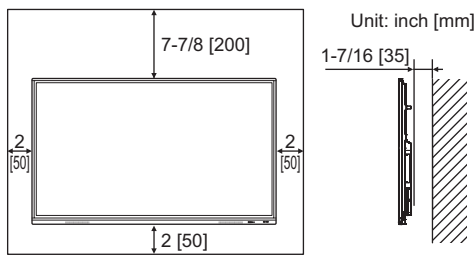

- If it is difficult to provide sufficient space for any reason such as the installation of the monitor inside a housing or of several units side-by-side, or if the ambient temperature may be outside of the range of 41°F (5°C) to 95°F (35°C), install a fan or take other measures to keep the ambient temperature within the required range.
- When installing two or more monitor units side-by-side, provide space of at least 3/16 inch (5 mm) around them to prevent stress on the adjacent unit or structure due to thermal expansion.
- Temperature condition may change when using the monitor together with the optional equipments recommended by SHARP. In such cases, please check the temperature condition specified by the optional equipments.
- Do not block any ventilation openings. If the temperature inside the monitor rises, this could lead to a malfunction.
- Do not place the monitor on a device which generates heat.
- Do not use the product in locations where the unit is exposed to direct sunlight or other strong light. Since this product operates with infrared rays, such light may cause a malfunction.
- When using multiple monitors closely, be sure the infrared transmitter/receiver does not affect the other ones.

Contents

IMPORTANT INFORMATION	3	Whiteboard	29
DEAR SHARP CUSTOMER	4	Drawing.....	31
SAFETY PRECAUTIONS	4	Erasing a drawn line.....	31
TIPS AND SAFETY INSTRUCTIONS	6	Actions using your finger (gesture).....	32
MOUNTING PRECAUTIONS	7	Opening a PDF or image on the current sheet.....	32
Supplied Components	9	Opening a file.....	32
System Requirements	9	Saving a sheet.....	33
Part Names	10	Erasing all lines drawn on the current sheet.....	33
Connecting Peripheral Equipment	12	Clearing a PDF or an image opened on the current sheet.....	33
Connecting the Power Cord	14	Deleting a sheet.....	33
Binding Cables	14	Settings.....	34
Preparing the Remote Control Unit	15	Bytello Share	35
Installing the batteries.....	15	PDF Viewer	37
Remote control operation range.....	15	File Explorer	38
Mounting a web camera	16	Web Browser	40
Attaching the wireless adapter	17	Updating the Software (Update)	41
Turning Power On/Off	18	Common Settings Menu	42
Turning on the main power.....	18	Displaying the menu screen.....	42
Turning power on.....	18	Menu item details.....	42
Turning power off.....	19	Adjustments for computer screen display.....	44
Sleep (Backlight off).....	19	Administrator Settings Menu	45
Touch Pen	20	Displaying the menu screen.....	45
Touch action	21	Menu item details.....	46
Touch action.....	21	Reset/Functional Restriction Setting (FUNCTION Menu)	50
Cautionary points.....	21	Controlling the Monitor with a computer (RS-232C)...	51
Basic Operation	22	Computer connection.....	51
About the home screen of APPLICATION mode.....	22	Communication conditions.....	51
Using the remote control unit.....	24	Communication procedure.....	51
Overlay board (Mark).....	27	RS-232C command table.....	53
Freeze.....	28	Troubleshooting	55
		Specifications	57
		Intellectual Property Rights and Other Matters	62
		Mounting Precautions	
		(For SHARP dealers and service engineers)	63

Supplied Components

If any component should be missing, please contact your dealer.

- Liquid Crystal Display Monitor: 1
- Remote control unit: 1
- Cable clamp: 4



- Power cord: 1
- Remote control unit battery: 2
- Setup Manual: 1

- Touch pen: 2
- Camera mount: 1
- Camera mount screw (M3x10): 2
- Camera screw (inch thread): 1
- Player mount: 1
- Player mount screw (M3x6): 2
- Wireless adapter: 1
- USB cable: 1
- Cover SHARP logo: 1

Place this sticker onto the SHARP logo to cover the logo.

* For environmental protection!

Do not dispose of batteries in household waste. Follow the disposal instructions for your area.

System Requirements

Hardware	Must have a USB 2.0 compliant port.
Operating system	Windows 8.1, Windows 10, Windows 11
	macOS v10.15, v11, v12
	Google Chrome OS Version 87 or later

To use the touch panel with an HDMI / D-sub connection, connect the supplied USB cable to the computer.

The touch panel and touch pen operate with the standard driver of each operating system. On the Mac, operation is only possible in mouse mode.

The Information Display Downloader can also be downloaded from the following website.

<https://business.sharpusa.com/product-downloads>

When the Information Display Downloader is installed, you can check and download the most recent versions of the software programs.

To install the software, see the manual for each.

Pen Software setup program and Touch Viewer setup program can be downloaded using Information Display Downloader.

Part Names

■ Front view

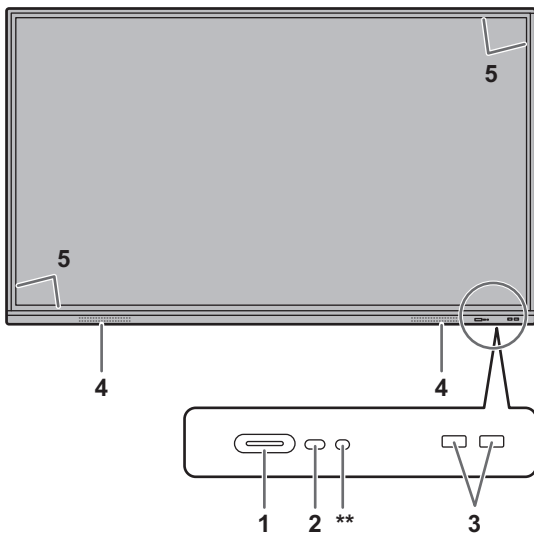

■ Rear view

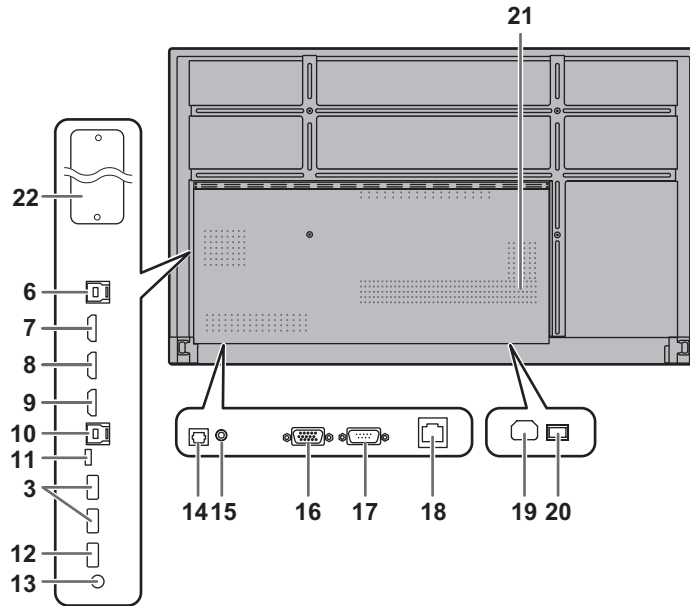

1. **POWER button / Power LED** (See page 18.)
2. **Remote control sensor** (See page 15.)
3. **USB port (USB 3.0 compliant)** (See page 13.)
4. **Speakers**
5. **Infrared transmitter/receiver**
6. **TOUCH PANEL1 terminal** (See page 12.)
7. **HDMI1 input terminal** (See page 12.)
8. **HDMI2 input terminal** (See page 12.)
9. **HDMI3 input terminal** (See page 12.)
10. **TOUCH PANEL2 terminal** (See page 12.)
11. **USB Type C port** (See page 12.)
12. **USB port (USB 2.0 compliant)** (See page 13.)
13. **Audio output terminal** (See page 13.)
14. **Digital audio output (optical) terminal** (See page 13.)
15. **Audio input terminal** (See page 12.)
16. **D-sub input terminal** (See page 12.)
17. **RS-232C input terminal** (See page 13.)
18. **LAN terminal** (See page 13.)

19. **AC input terminal** (See page 14)
20. **Main power switch** (See page 18.)
21. **Vents**
22. **Expansion slot**

This section is used to connect optional hardware for function expansion. Offering this attachment location is not a guarantee that future compatible hardware attachments will be released.

If a Windows computer is using the OPS slot, this monitor will not enter standby state while displaying the Windows Login screen.

* If you turn off the monitor while OPS Module is in sleep mode, the OPS module may malfunction. Do not perform the following operations or settings on the OPS Module.

- Go to sleep mode.
- Turn off the monitor.

** This is not used with this monitor.

TIPS

- It is possible to use the terminals for separate purposes; for example, using the TOUCH PANEL2 terminal to connect a fixed computer and using the TOUCH PANEL1 terminal to connect a mobile computer.

! Caution

- Consult your SHARP dealer for attachment/detachment of optional parts.

■ Remote control unit

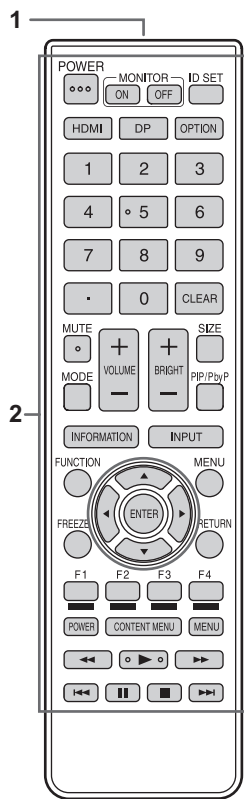

1. Signal transmitter
2. Operation buttons (See page 24.)

Connecting Peripheral Equipment

■ Front view

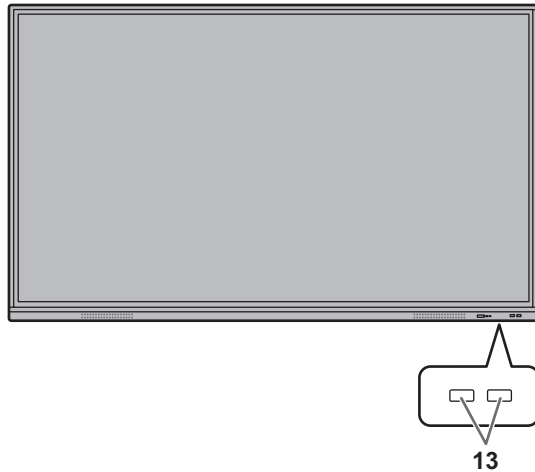

■ Rear view

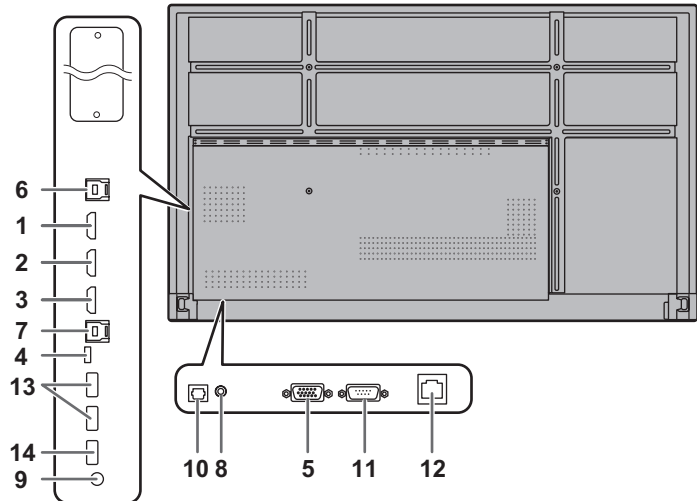

! Caution

- Be sure to turn off the main power switch and disconnect the plug from the power outlet before connecting/ disconnecting cables. Also, read the manual of the equipment to be connected.
- Be careful not to confuse the input terminal with the output terminal when connecting cables. Accidentally reversing cables connected to the input and output terminals may cause malfunctions and the other problems.
- Do not use any cable that has a damaged or deformed terminal. Using such cables may cause malfunctions.

TIPS

- Images may not be displayed properly depending on the computer (video card) to be connected.
- Use the automatic screen adjustment when a computer screen is displayed for the first time using D-SUB or when the setting of the computer is changed.
- If the audio output from the playback device is connected directly to speakers or other devices, the video on the monitor may appear delayed from the audio portion. Audio should be played through this monitor by connecting the playback device to the monitor's audio input, and connecting the monitor's audio output to the speakers or other devices.

The TOUCH PANEL terminal is USB3.0 Type B. Although the connector shape is different, the supplied USB cable (USB 2.0 Type B) can be connected to the TOUCH PANEL terminal.

1. HDMI1 input terminal (support HDMI CEC)

2. HDMI2 input terminal

3. HDMI3 input terminal

- Use a commercially available HDMI cable (conforming to the HDMI standard) that supports 4K.

4. USB Type C port

- Connect to the computer with a commercially available USB cable (type C).
- You can connect a device that supports DisplayPort alternate mode. In order to supply power to connected devices, it is necessary to support the Power delivery standard.
- There is no need to connect the USB cable to the TOUCH PANEL terminal.
- When input mode is change to USB-C, this monitor will be recognized by the connected computer.

5. D-sub input terminal

6. TOUCH PANEL1 terminal

- To use the touch panel with a computer connected to an HDMI1 input terminal or an HDMI2 input terminal, connect the touch panel to the computer with a USB cable (USB2.0 Type B or USB3.0 Type B).

7. TOUCH PANEL2 terminal

- To use the touch panel with a computer connected to an HDMI3 input terminal or a D-sub input terminal, connect the touch panel to the computer with a USB cable (USB2.0 Type B or USB3.0 Type B).

8. Audio input terminal

- Use an audio cable without resistance.

9. Audio output terminal

- The output sound varies depending on the input mode.
- The volume of the output sound can be fixed by setting “Audio Output” of “Input & Output” on the Administrator Settings menu.
- It is not possible to control the sound output from the audio output terminals with the Audio menu.

10. Digital audio output (optical) terminal

- Audio that is input into the monitor is output.
- Connect using a commercially available audio digital cable.
- The output sound varies depending on the input mode.

11. RS-232C input terminal

- You can control the monitor from a computer by connecting a commercially available RS-232 straight cable between these terminals and the computer.

12. LAN terminal

- You can connect to a network by using a commercially available LAN cable.

13. USB port (USB3.0 compliant, Type-A)

- When the input mode is HDMI1 or HDMI2, the USB port can be used for a computer connected to the TOUCH PANEL1 terminal.
- When the input mode is HDMI3 or D-SUB, the USB port can be used for a computer connected to the TOUCH PANEL2 terminal.
- When the input mode is APPLICATION, the USB port can be used for APPLICATION mode.

! Caution

- Do not switch the input mode when a USB flash drive is connected. This could corrupt the data on the USB flash drive. Switch the input mode after removing the USB flash drive. To save data to the USB flash drive, connect the USB flash drive to the USB port (USB2.0 compliant, Type-A).

14. USB port (USB2.0 compliant, Type-A)

- The USB port can be used for APPLICATION mode.

■ USB port for the APPLICATION mode

- Connect USB devices (memory device, keyboard, mouse) that you want to use in “APPLICATION” mode.

Supported USB flash drives

File System	FAT32/NTFS (Read only)
Capacity	Up to 64 GB (For FAT32, the maximum file size is 4 GB)

- A USB flash drive that is encrypted or has a security function cannot be used.
- Use a USB flash drive with a shape that can be inserted in the USB port. Some USB flash drives with special shapes cannot be inserted. Do not forcibly insert a USB flash drive. This may damage the connector or cause failure.

TIPS

- You can prohibit the use of USB flash drive. (See page 46.)

■ How to remove a USB flash drive

1. Start “File Explorer”. (See page 38.)
2. Select the USB flash drive to remove, and then touch



TIPS

- To remove a USB flash drive connected to a computer, refer to the manual of the computer.

Connecting the Power Cord

! Caution

- Use only the power cord supplied with the monitor.
1. Turn off the main power switch.
 2. Plug the power cord (supplied) into the AC input terminal.
 3. Plug the power cord (supplied) into the power outlet.

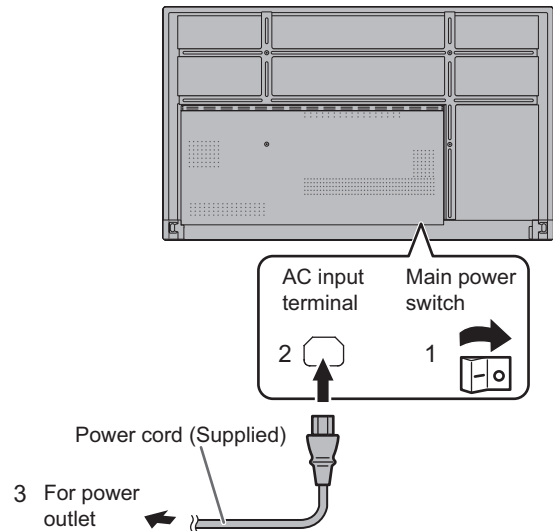

Binding Cables

The supplied cable clamps can be used to clamp the power cord and cables connected to the back of the monitor. Attach the supplied cable clamps to a flat surface, removing any dust or dirt before attaching. Do not attach over a vent.

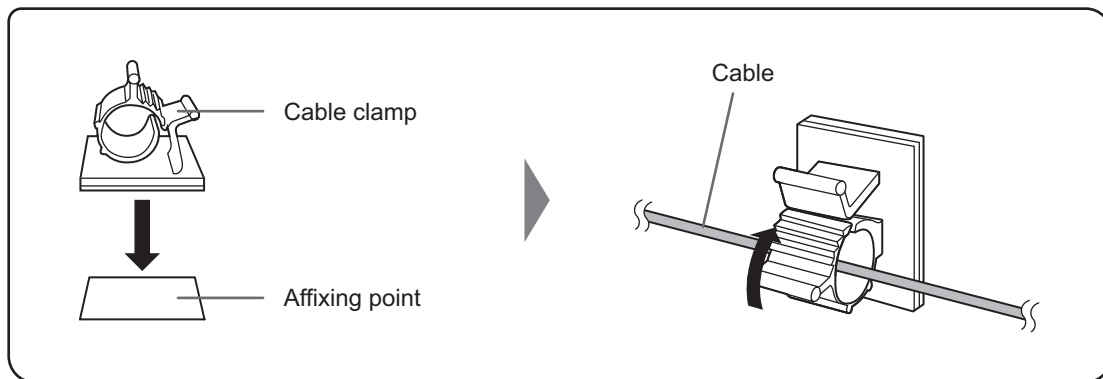

Preparing the Remote Control Unit

Installing the batteries

1. Place your finger on the part marked with the ▲, and then pull the cover off.

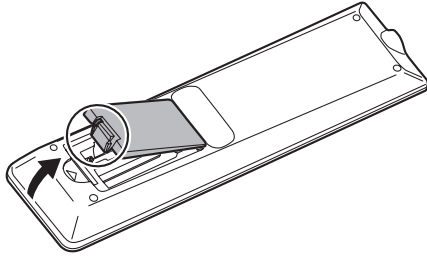

2. See the instructions in the compartment and put in the batteries (R03 or LR03 (“AAA” size) x 2) with their plus (+) and minus (-) sides oriented correctly.
3. Close the cover.

TIPS

- When the batteries become exhausted, replace them with new (commercially available) batteries.
- The supplied batteries may become exhausted quickly depending on how they are stored.
- If you will not be using the remote control for a long time, remove the batteries.
- Use manganese or alkaline batteries only.

Remote control operation range

The operation range of the remote control unit is approx. 16.4 feet (5 m) at an angle of approx 10° from the center to the top/bottom/right/left of the remote control sensor.

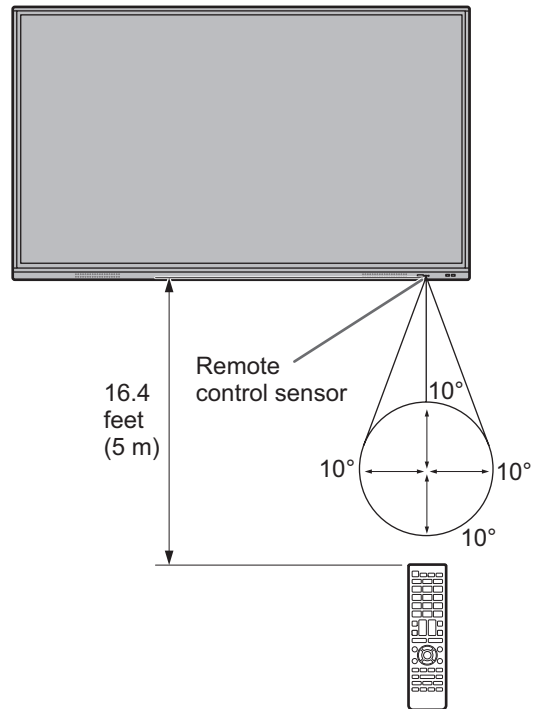

TIPS

- Do not expose the remote control unit to shock by dropping or stepping on it. This could lead to a malfunction.
- Do not expose the remote control unit to liquids, and do not place it in an area with high humidity.
- The remote control unit may not work properly if the remote control sensor is under direct sunlight or strong lighting.
- Objects between the remote control unit and the remote control sensor may prevent proper operation.
- Replace the batteries when they run low as this may shorten the remote control's operation range.
- If a fluorescent light is illuminated near the remote control unit, it may interfere with proper operation.
- Do not use it with the remote control of other equipment such as air conditioner, stereo components, etc.

Mounting a web camera

It is possible to mount the PN-ZCMS1 Video-Conferencing Soundbar (optional) or a commercially available web camera.

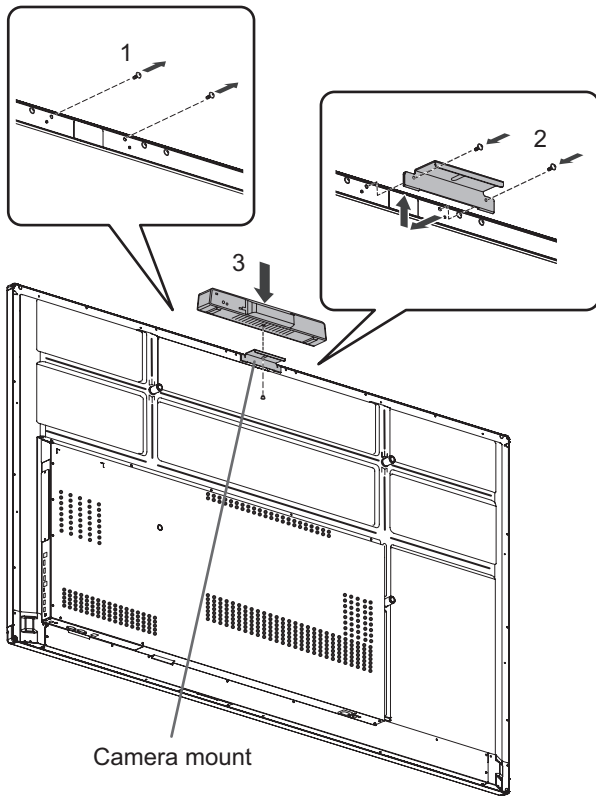

1. Remove the screws from this monitor.
2. Attach the camera mount (supplied) with the camera mount screw (M3 x 10) (supplied) (x2).
3. Attach the web camera on the camera mount with the camera screw (inch thread) (supplied) (x1).

TIPS

- Store the removed screws.
After removing the camera mount, put back the removed screws.

Attaching the wireless adapter

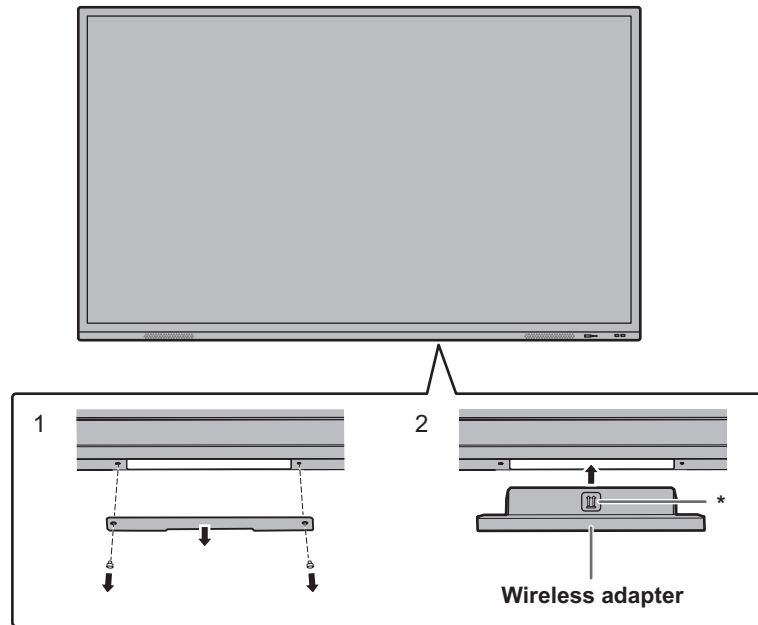

1. Remove the bottom cover.

2. Attach a wireless adapter.

Take note of the direction of the wireless adapter.
The surface with the * mark is the front.

TIPS

- Store the removed cover and screws.
After removing the wireless adapter, put back the cover, and fasten it with the removed screws.

Turning Power On/Off

! Caution

- Turn on the monitor first before turning on the computer or playback device.
- When switching the main power switch or the POWER button off and back on, always wait for at least 5 seconds. A short interval may result in a malfunction.

Turning on the main power

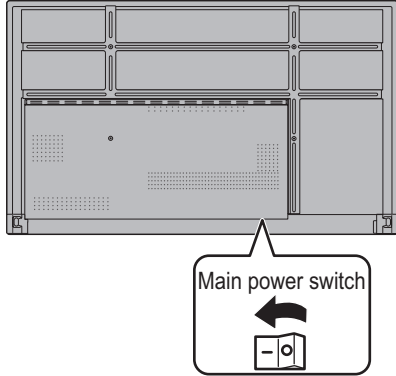

Off mode, when main power is off.

! Caution

- The main power must be turned on/off with the main power switch. Do not connect/disconnect the power cord or turn the breaker on/off while the main power switch is on.
- For a complete electrical disconnection, pull out the main plug.

Turning power on

1. Press the POWER button.

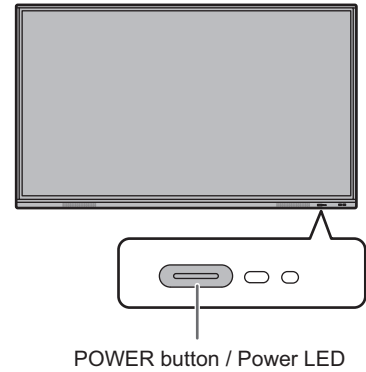
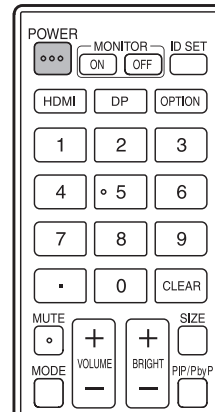

Status	Status of the monitor
Blue lit	Power on Sleep state (Backlight off)
Orange lit	Power off (Standby state*)
Blue flashing	Input signal waiting state

* Standby mode when "Power Save Mode" is set to on.

TIPS

- When the main power switch is off, the monitor cannot be turned on.
- If the monitor is in the input signal waiting state and you perform the operation described below, the monitor enters standby state.
 - Press the POWER button on the remote control unit.
 - Press and hold the POWER button on the monitor.
- To disable the logo screen from displaying when turning the power on, set "Logo Screen" to off on the Setup menu.
- You can fix the input mode that appears after startup. Set "Start Input Mode" of "Startup & Shutdown" on the System menu. (See page 48.)

■ Operations after first power-on

When you turn on the power for the first time, the language settings screen appears.

1. Select a language, and then touch “Next”.

The “Date & Time Settings” screen appears.

2. Set the date and time, and then touch “Next”.

The power save mode settings screen appears.

3. Configure the settings according to the screen.

YES:

- “Power Save Mode” is set to on.
- Current consumption is reduced while the monitor is in standby state. Android is also shut down. Note, however, that the startup time from standby state becomes longer.

NO:

- “Power Save Mode” is set to off.
- Startup time from standby state is reduced. Note, however, that more power will be consumed in standby state. Android continues to run in standby state.

Even after being set, you can change the “Power Save Mode”. (See page 46.)

4. When a screen indicating that the settings are complete appears, touch “Finish”.

The home screen of APPLICATION mode appears.

(See page 22.)



TIPS

The clock stops if the main power remains off for about 3 days.*

(*Approximate time. The actual time varies depending on the state of the monitor.)

Turning power off

1. Press the **POWER** button on the remote control unit.
Or, press and hold the **POWER** button on the monitor.

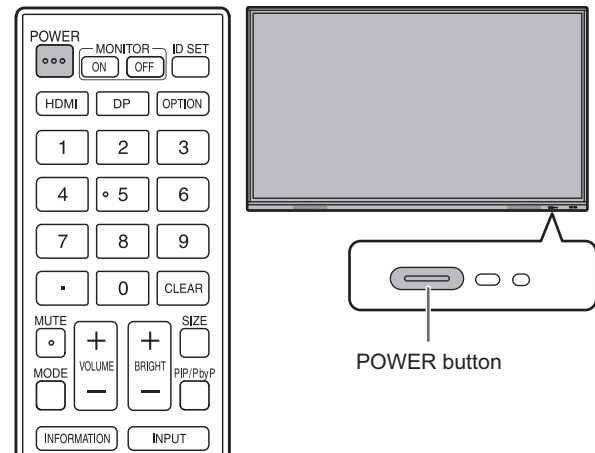

A confirmation screen appears.

2. Select “OK”.

The power will turn off. (Standby state)

!Caution

- When the power is turned off, the application data that is not saved is lost.
- A message is displayed before the power turns off. Save any data you need.
- If the monitor will be turned off by schedule, “Off if No Operation” or RS-232C control, save any data you need in advance. The power will turn off even if there is unsaved data. (The data will be lost.)

Sleep (Backlight off)

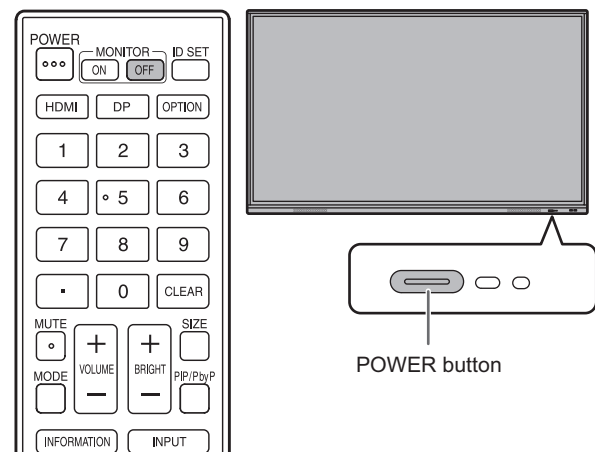

1. Press the **MONITOR OFF** button on the remote control unit.

Or, press the **POWER** button on the monitor.

The backlight will turn off.

The previous state can be restored by touching the screen or pressing any button (excluding MONITOR OFF, PIP/PbyP).

Touch Pen

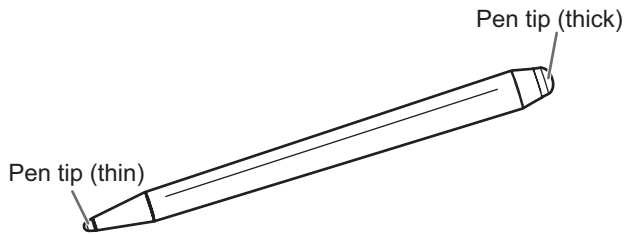

The following software recognizes the side of the touch pen that is touching the screen, enabling the two sides to be used as different pens.

- Whiteboard

For details on how to use the touch pen in Whiteboard, refer to “Whiteboard” (see page 29).

TIPS

- In the case of an Overlay board (See page 27.), multiple touch pens can be used simultaneously. In other cases, multiple touch pens cannot be used simultaneously.
- When multiple touch pens are used on an Overlay board (See page 27.), lines may break.
 - When touched simultaneously.
 - When touch pens are moved near each other.
- If the pen tip becomes worn or damaged, replace the touch pen. To purchase a new touch pen, consult your dealer.

The supplied touch pen is attached to this monitor.

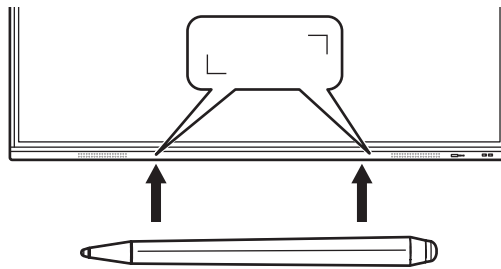

TIPS

- Do not attach anything other than the supplied touch pen.
- Magnet is used to attach the supplied touch pen. Do not move close watch or magnetic card to it.

Touch action

Touch action

Touch actions that can be used with this monitor differ according to operating system and application. The functions of touch actions are also different. For details, check operating system Help and the application's support documentation.

TIPS

- On the Mac, the actions are the equivalent mouse actions.
- For the procedures for using the touch pen in the Pen Software, see the Pen Software Operation Manual.
- The screen may not respond correctly in the following cases:
 - Touch gesture is too quick.
 - The distance between the two points is too short.
 - The two points intersect.
- In Windows 8.1/10, input panel functions can be used. For details, see Windows Help.
Input panel: A software keyboard and an input panel with handwriting recognition appear on the screen.
- In Windows 8.1/10, the ink function of Microsoft Office can be used. Handwritten comments can be written, and handwriting can be recognized. For details, see Microsoft Office Help.

Cautionary points









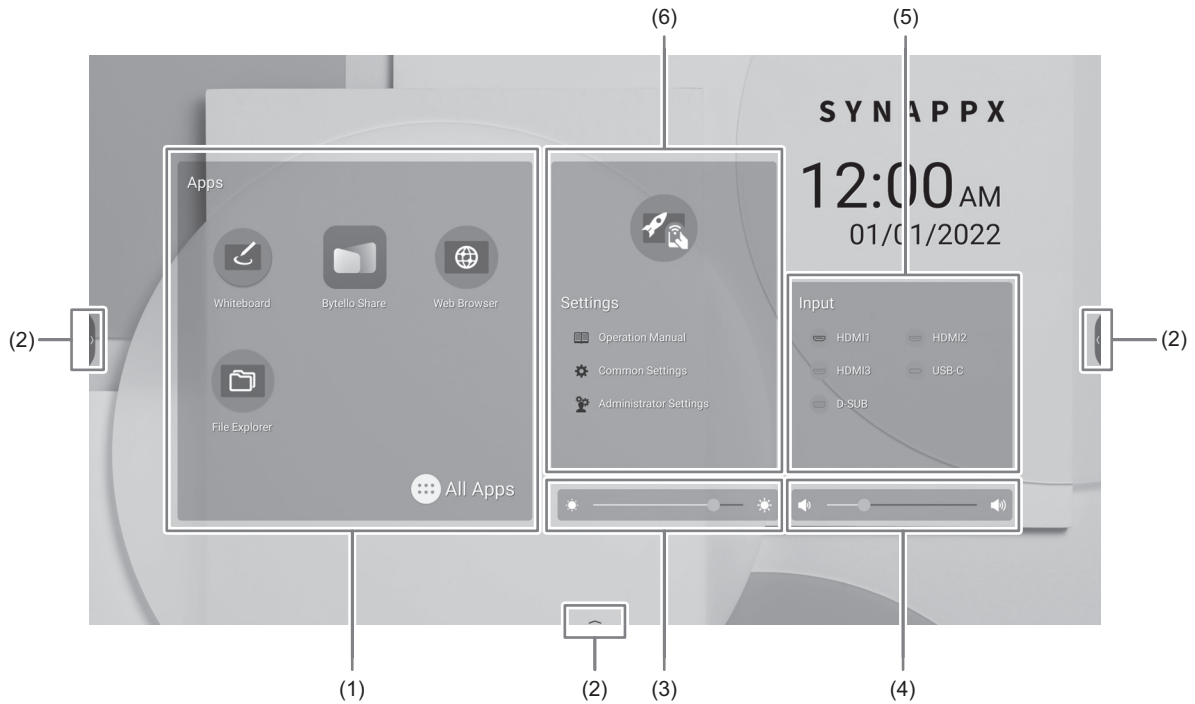

- Do not use the touch pen for any purpose other than touch panel operation.
- Do not press hard on the pen tip.
- Operation will not take place correctly if there is an obstacle between the infrared transmitter/receiver and the touch pen or your finger. Operation will not take place correctly if your fingers or your sleeve is near the screen.
- If the touch pen is held too flat against the screen, the touch position may not be correctly detected.
- If the touch pen does not work at the edge of the screen, move it slowly.
- This may not operate correctly if there is an inverter fluorescent light nearby.
- If there is dirt or foreign matter on the tip of the touch pen, remove it. Foreign matter may damage the screen.
- The touch pen position may occasionally deviate in the login screen. In this case, use the keyboard or mouse.
- If the USB cable becomes disconnected, the touch panel may not operate correctly after the USB cable is reconnected. In this case, restart the computer.
- When removing the pen tip or your finger from the screen, remove a sufficient distance. If the distance is not sufficient, a touch may be detected even if the screen is not touched.

Basic Operation

About the home screen of APPLICATION mode

This appears when the input mode is changed to APPLICATION.



- (1)  Start "Whiteboard". (See page 29.)
-  Start "Bytello Share". (See page 35.)
-  Start "Web Browser". (See page 40.)
-  Start "File Explorer". (See page 38.)
-  Display the list of applications.
-  Display "Updater". (See page 41.)
-  Start "Whiteboard". (See page 29.)
-  Start "Bytello Share". (See page 35.)
-  Start "Web Browser". (See page 40.)
-  Start "File Explorer". (See page 38.)
-  Confirm the downloaded file.

TIPS

- When a confirmation screen to allow access appears when the application is started for the first time, select "Allow".

- (2) When you touch the screen, “”, “”, and “” appear.

Touch to view the toolbar.



Go back to previous screen.*



Return to home screen of APPLICATION mode.



Display a preview of the application being executed and the last external input. (See below.) *



Display “Input” menu. (See page 25.)



Start “Overlay board”. (See page 27.)



Start “Bytello Share”. (See page 35.)



Display the images being shown on the monitor as stills. (See page 28.)

* Displayed when the input mode is APPLICATION mode.

- (3) Adjust the brightness.
 (4) Adjust the volume.
 (5) Change the input mode.

Input mode	Video	Audio
APPLICATION	APPLICATION	APPLICATION
HDMI1	HDMI1 input terminal	HDMI1 input terminal
HDMI2	HDMI2 input terminal	HDMI2 input terminal
HDMI3	HDMI3 input terminal	HDMI3 input terminal
D-SUB	D-sub input terminal	Audio input terminal
USB-C	USB Type C port	USB Type C port
OPS	Expansion slot	Expansion slot

The icon of the terminal that is not connected is grayed out.

- (6) Display the manual of this monitor and make various settings.



Switch the input mode to a computer on which “Synappx” is installed. *



Display the manual of this monitor.



Display the “Common Settings” menu. (See page 42.)



Display the “Administrator Settings” menu. (See page 45.)

* Set which input mode to switch in “Synappx Settings” on the Setup menu.

Synappx applications work with your current office technology to bring smart home convenience into the workplace.

Have a smooth meeting. Share or print information right where it’s needed. For details on Synappx, see the Synappx manual.

■ List display of startup applications (recent app bars)

When you touch on the toolbar in APPLICATION mode, a preview of the application being executed and the last external input is displayed.

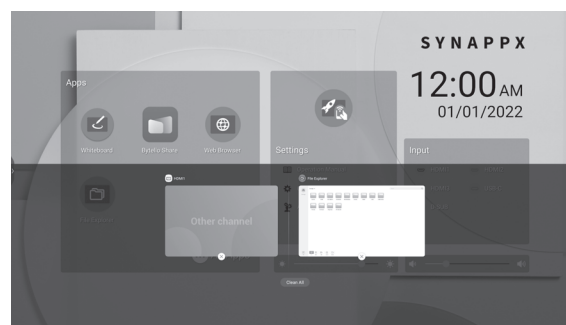

- When you touch the preview, the display switches to that application.
- Touch to exit the application.
- Touch “Clean All” to exit all applications.

TIPS

- When you touch on the toolbar displayed on the side, the recent app bar is displayed on the side.
- A preview of the whiteboard is not displayed.

Using the remote control unit

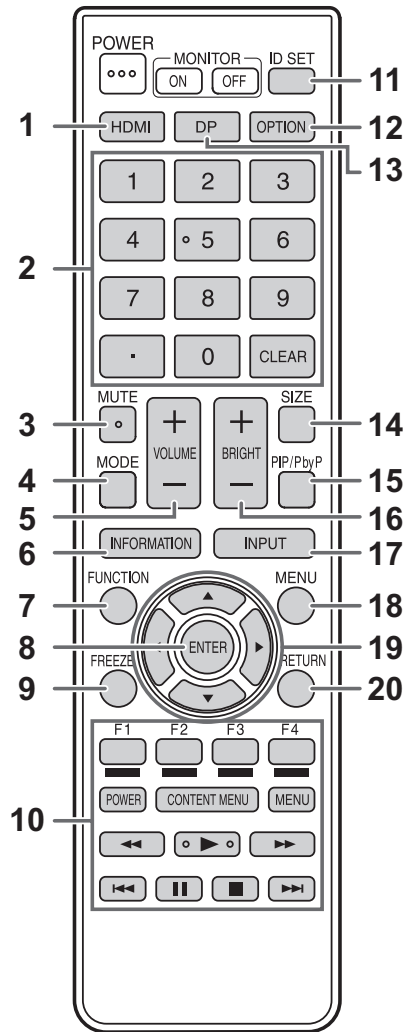

1. HDMI

Switch the input mode to HDMI1, HDMI2 or HDMI3.

2. Numeric input buttons

These buttons are used for setting such as LAN setting.

3. MUTE

Turns off the volume temporarily.

Press the MUTE button again to turn the sound back to the previous level.

4. MODE (Color mode selection)

In video input mode (other than "APPLICATION"), the color mode changes.

The menu is displayed.

Press the ▲ or ▼ button to select the color mode.

- High Illuminance is a display with colors suited to bright locations.

5. VOLUME +/- (Volume adjustment)

Press + or - to adjust the volume.

6. INFORMATION

Displays monitor information.

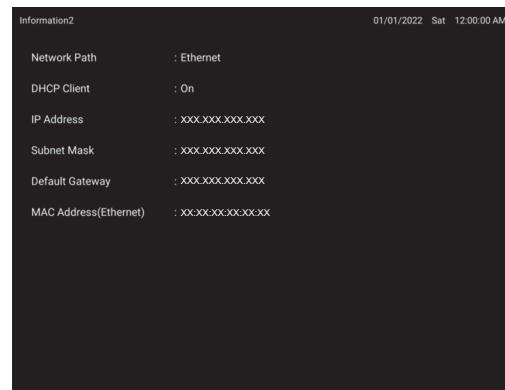
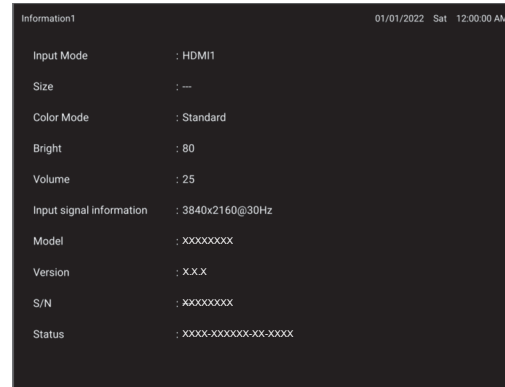

The display changes from "Information1" → "Information2" → clear display, and so on every time you press this button.

When displaying "Information", the display changes from "Information1" → "Information2" → "Information1", and so on every time you press the ► button.

Pressing the RETURN button disappears the display.

- The display disappears automatically after about 15 seconds.

7. FUNCTION

Use this to display the FUNCTION menu. (See page 50.)

8. ENTER

Confirms the setting.

9. FREEZE

Freezes the video shown on the monitor. (See page 28.)

In some cases a residual image may occur. Do not freeze the video for a long time.

10. Buttons for operating the HDMI-connected device

If “HDMI CEC Link” is set to on, you can operate devices that support HDMI CEC when the input mode is HDMI1.

CONTENT MENU button

- When input mode is APPLICATION
 - The home screen of APPLICATION mode appears.
- When “HDMI CEC Link” is set to on and input mode is HDMI1
 - Operate devices that support HDMI CEC.
- When “HDMI CEC Link” is set to off and input mode is other than APPLICATION
 - The input mode changes to APPLICATION.

11. ID SET

This is not used with this monitor.

12. OPTION

Switch the input mode to APPLICATION or OPS.

13. DP (DisplayPort)

Switch the input mode to USB-C.

14. SIZE (Screen size selection)

In video input mode (other than APPLICATION), the screen size changes.

The menu is displayed.

Press the ▲ or ▼ button to select the screen size. (See page 26.)

15. PIP/PbyP

This is not used with this monitor.

16. BRIGHT +/- (Brightness adjustment)

Press + or - to adjust the brightness.

17. INPUT (Input mode selection)

The menu is displayed.

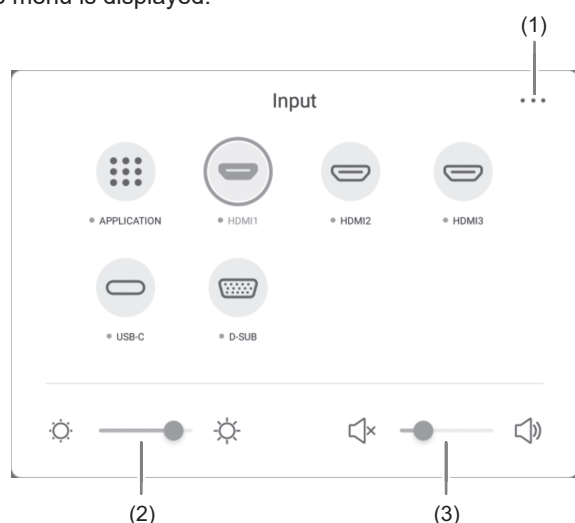

Press the ▲▼◀▶ button to select the input mode, and press the ENTER button to enter.

* For the input modes that can be selected, see “About the home screen of APPLICATION mode” (see page 22).

(1) Displays the Common Settings menu screen.

(See page 42.)

(2) Adjust the brightness.

(3) Adjust the volume.

18. MENU

Displays the Common Settings menu screen. (See page 42.)

19. Cursor

These buttons are used to perform operations such as selecting items, changing adjustment values, and moving the cursor.

20. RETURN

Returns to the previous screen.

Basic Operation

■ Switching the screen size

Even when the screen size is changed, the display may remain the same depending on the input signal.

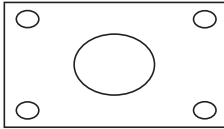
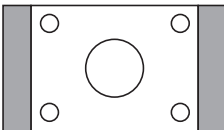
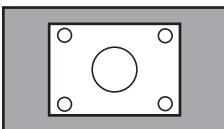
Wide		Displays image so it fills the entire screen.
Normal		Displays the image so it fills the screen without changing the aspect ratio.
Dot by Dot		Displays the dots of the input signals as the corresponding dots on the screen.

TIPS

- Using this monitor's screen-size switching function to compress or expand the screen for commercial or public viewing in establishments like cafes or hotels may infringe on the rights of the creators, as protected by Copyright Law, so please be careful.
- The appearance of the original video may change if you select a screen size with a different aspect ratio than the original image (e.g. TV broadcast or video input from external equipment).
- When 4:3 video is viewed with the whole screen using the screen-size switching function of this monitor, the edge of the video may be lost or appear distorted. If you wish to respect the creator's intentions, set the screen size to "Normal".
- When playing commercial software, parts of the image (like subtitles) may be cropped. In this case select the optimal screen size using the screen-size switching function of this monitor. With some software, there may be noise or distortion at the edges of the screen. This is due to the characteristics of the software, and is not a malfunction.
- Depending on the original video size, black bands may remain at the edges of the screen.





Overlay board (Mark)

You can draw characters or lines on the images being displayed on this monitor.

Touch  on the toolbar.



Operation bar

Tool	Function
 Pen	Draw a line. You can change the settings (color).
 Brush	Draws a line without hiding objects under the line. You can change the settings (color).
 Clean	Clear all the drawn lines.
 Save	Save a board that is being drawn as an image. The image will be saved in the "Notes/Mark" folder.
 Close	Exit the application.

You can erase an area of the screen that you touch with your palm.
Touch the screen with your palm, and when the cursor is appear, move your palm.

TIPS

- The operation bar can be moved by dragging.
- You cannot save a board in the USB flash drive.
After saving it in the internal storage, copy it to the USB flash drive with "File Explorer".
- Cannot be saved when HDCP-compliant images input from the HDMI input terminal / USB Type-C port / OPS are being displayed.
- You cannot add a sheet.

Freeze

Freezes the video shown on the monitor.

Either press the FREEZE button on the remote control unit, or touch  on the toolbar.





In the case of a still image,  is displayed at the top right of the screen.



Settings window

Settings window:

Touch to operate.

-  Magnify any location on the screen.
-  Reduce a magnified screen.
-  Display on full screen.
-  Cancel the still state.

! Caution

- In some cases a residual image may occur. Do not freeze the video for a long time.

TIPS

- If you want to mute the audio from a still image, set "Mute with Freeze" on the Input & Output menu to on.
- To cancel, press any button other than the POWER button, MUTE button or VOLUME button on the remote control unit. Freeze is also canceled when the input signal changes (switching to no signal, changing the resolution, etc.).

Whiteboard

- You can write letters or draw lines on the screen as a whiteboard.
- You can print or save content written on the screen.
- You can display an image or PDF file, and write/draw letters and lines on the image.
- In this application, the data of one screen is referred to as a “sheet”.
- A maximum of 10 sheets can be opened.



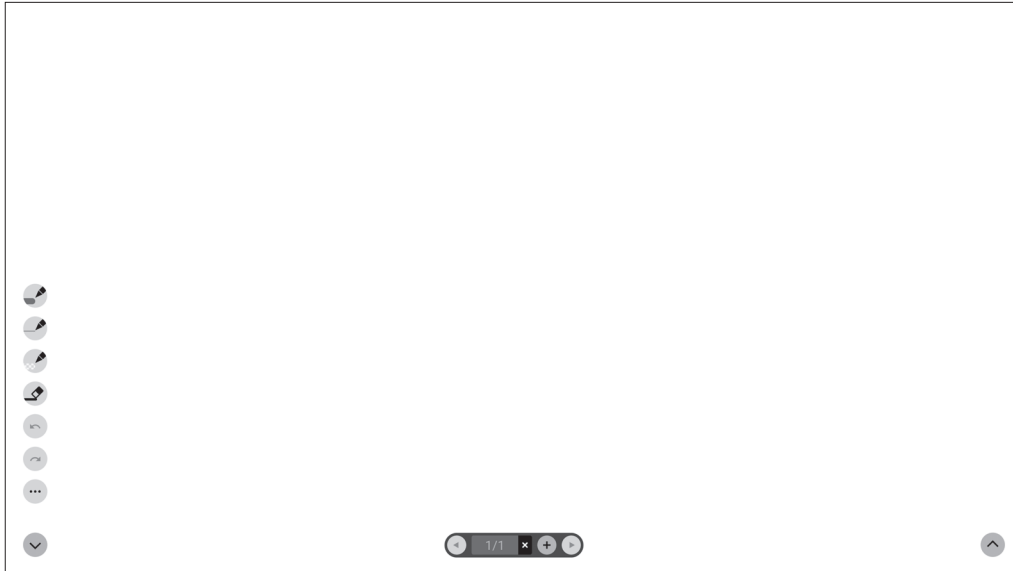













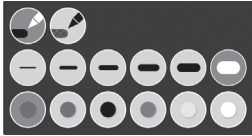











1. On the home screen of APPLICATION mode, touch “Whiteboard”.



! Caution

- When the power is turned off, any data in Whiteboard is lost.
- A message is displayed before the power turns OFF. Save any data you need.

■ Function list

Tool	Function
  	Draw lines. (See page 31.) <div style="float: right; text-align: right;"> Pen palette 1 —  Pen palette 2 —  Pen palette 3 —  </div> 
	Erase a line that you drew. (See page 31.) <div style="float: right;">  </div>
	This appears when “Draw with pen and finger” is selected. (See page 34.) Touch to perform gesture actions (enlarging/reducing, moving a sheet, etc.). (See page 32.)
	Undo the previous drawing or edit. You can repeat undo a maximum of 50 times.
	Redo an undone action.
	The sub-menu will appear. To close the sub-menu, touch  .
	Save/open a sheet. You can open an image or PDF file and use it as the background.
	Delete a drawn line, opened image, or a sheet. (See page 33.)
	Print a sheet.
	Change the settings of this application. (See page 34.) You can check the version of the application.
	Exit this application.
 	Show/hide the tools. Touch  to show the tools, or  to hide the tools. If you touch  on the opposite side when the tools appear, the displayed tools are hidden and the tools on the opposite side are shown.
	Display the previous sheet.
	Shows the current sheet number and the total number of sheets.
	Delete the currently displayed sheet.
	Add a new sheet behind the currently displayed sheet.
	Display the next sheet.

TIPS

- Multiple touch pens or fingers cannot be used simultaneously.

Drawing

The line/eraser setting is assigned to each touch pen (thin/thick) and finger.
Operate with what you use to draw.

1. Touch one of “Pen palette 1” to “Pen palette 3”.

If the line you want to draw does not exist, touch one of “Pen palette 1” to “Pen palette 3” twice. You can change the line setting (non-transparent/transparent, thickness, color).

2. Draw.

TIPS

- On the touch pen (supplied), you can set the thin tip and thick tip of the pen separately.
When this software is launched, the thin tip is set to “Pen palette 1”, and the thick tip is set to “Eraser”.
- To draw with only a touch pen, select “Draw only with pen”. (See page 34.)
To use your finger to draw, select “Draw with pen and finger”. (See page 34.)
- When this software is launched, drawing by finger is set to “Pen palette 1”.

Erasing a drawn line

The line/eraser setting is assigned to each touch pen (thin/thick) and finger.
Operate with what you use to erase.

1. Touch .

To change the size of the eraser, touch  twice.

2. Move while continuing to touch the place you want to erase.

The part you move over is erased.

TIPS

- On the touch pen (supplied), you can set the thin tip and thick tip of the pen separately.
When this software is launched, the thin tip is set to “Pen palette 1”, and the thick tip is set to “Eraser”.
- To use your finger to erase, select “Draw with pen and finger”. (See page 34.)

You can erase an area of the screen that you touch with your palm.

Touch the screen with your palm, and when the cursor is appear, move your palm.

Actions using your finger (gesture)

Enlarge/reduce a sheet

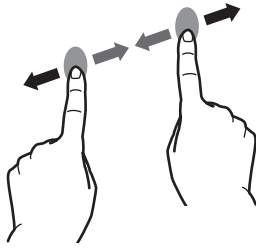

Pinch-in/pinch-out

Moving the display position of a sheet
(when enlarged)

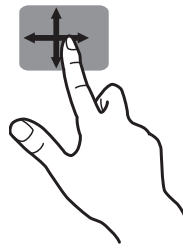

Swipe

Move to the previous/next* sheet

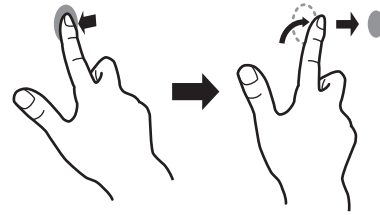

Left/right flick

* Add a new sheet when the last sheet is being displayed. (Up to 10 sheets)

When drawing with a touch pen (supplied)

(When "Draw only with pen" is selected (See page 34.))

Your finger can only be used for a gesture action.

When drawing with your finger

(When "Draw with pen and finger" is selected (See page 34.))

Touch  to perform a gesture action.

Opening a PDF or image on the current sheet



You can open a file in PDF format or an image (in JPEG or PNG format) on the current sheet.

- If there are lines drawn on the sheet, the file will appear under the lines.
- An opened image will appear in the full screen without changing the aspect ratio.
- Up to the 10 pages of a PDF file can be opened.
When there are multiple pages, the pages will appear in order starting from the current sheet.
- Depending on memory usage and other factors, it may not be possible to open a file even if it is in a supported format.

1. Touch , .
2. Touch "Insert a PDF or an image to background".
3. Select the file.

Opening a file

Data of this application that is saved in dedicated format (SDSW format) is opened as a new sheet.
The current sheet closes.

1. Touch , .
2. Touch "Open file".
3. Touch "Open without saving".
To save the current sheet, touch "Save" and perform the save procedure.
4. Select the file.



Saving a sheet

You can save a sheet in dedicated SDSW format or PDF format.



You can save the sheet to this monitor's built-in memory (internal memory) or to a USB flash drive.

TIPS

- When you save a sheet in SDSW format, you can open the sheet in this application and re-edit the sheet.
- When you save a sheet in PDF format, an opened image and drawn lines are all saved as a single image. (The sheet cannot be re-edited using this application.)
- The date and time of saving are automatically set in the file name. (Example: 180101_120000.sds / 180101_120000.pdf)

1. Touch , .
2. Touch **“Save” (SDSW format) or “Save as PDF”**.
A dialog box appears to let you specify the save location.
3. **Specify the file save location and the file name.**
4. Touch **“Save”**.



Erasing all lines drawn on the current sheet

1. Touch , .
2. Touch **“Clear drawing data on Current sheet”**.
A confirmation message will appear.
3. Touch **“Yes”**.



TIPS

- The sheet will not be deleted.

Clearing a PDF or an image opened on the current sheet



1. Touch , .
2. Touch **“Clear background image on Current sheet”**.
A confirmation message will appear.
3. Touch **“Yes”**.

Deleting a sheet

1. Touch , .
2. Touch **“Delete Current sheet” or “Delete All sheets”**.
A confirmation message will appear.
3. Touch **“Yes”**.
If you deleted all sheets, a new sheet will appear.

Settings

■ Drawing with your finger (Draw with pen and finger) / Drawing with only a touch pen (Draw only with pen)

1. Touch .
2. To draw with your finger: Touch “Draw with pen and finger”.
You can now draw with a touch pen and your finger.
Touch  before performing a gesture.
The button changes to “Draw only with pen”.
To draw with only a touch pen: Touch “Draw only with pen”.
You can now draw with only a touch pen.
Finger actions will now be gestures.
The button changes to “Draw with pen and finger”.

■ Returning the settings to their default state (Back to default settings)

1. Touch .
2. Touch “Back to default settings”.
3. When a confirmation message appears, touch “Yes”.

■ Checking the version of this software (Version Information)

1. Touch .
2. Touch “Version Information”.
3. When you have finished checking, touch “OK”.

Bytello Share

- You can display the image of another device on the same network on this monitor.
- Connections to all devices is not guaranteed.
- If the display is delayed, reduce the connected devices.
- “Bytello Share” is an application of Guangzhou Shirui Electronics Technology Co., Ltd. Functions may change due to updates by Guangzhou Shirui Electronics Technology Co., Ltd.

■ Startup

When the application is first started, it is necessary to connect to the Internet for the authentication of the application.

1. On the home screen of APPLICATION mode, touch “Bytello Share”.

Or, touch  on the toolbar.

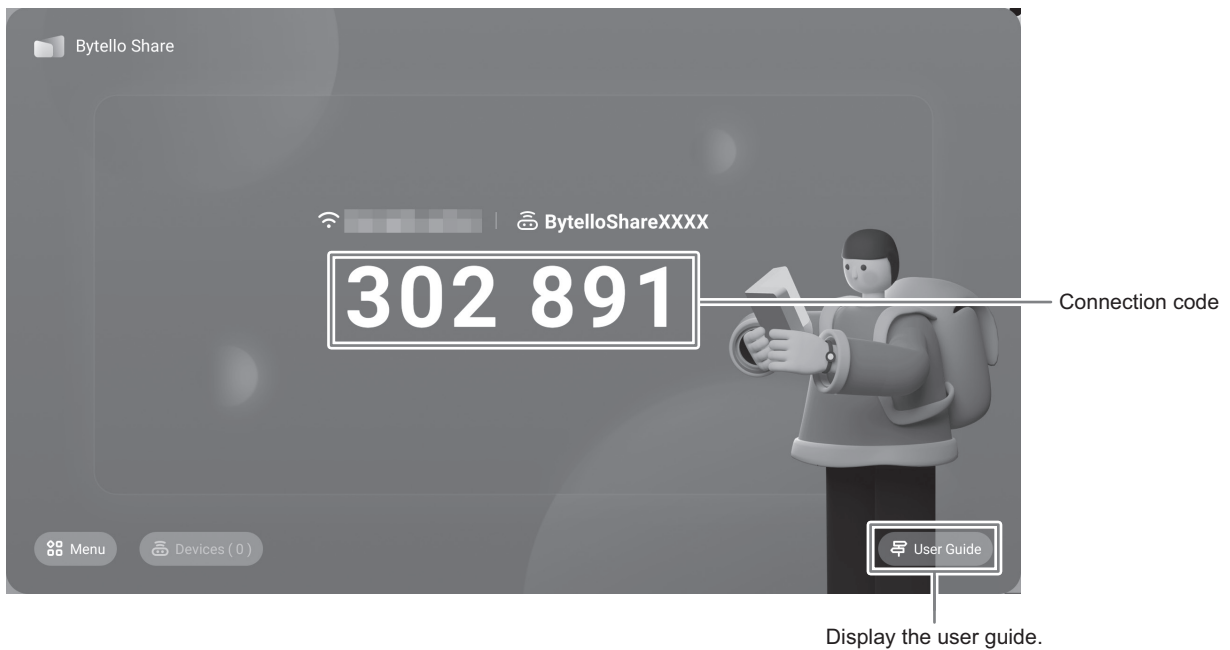

■ Preparing the device

- You must connect to the Internet.
- Access the URL specified in “User Guide”, and the download and install the application.
You can also access by scanning the QR code.

■ Operating the device

- The screen is simply an example. It varies depending on the version of the device (OS) and application.

1. Connect to the same network as this monitor, and start the application.

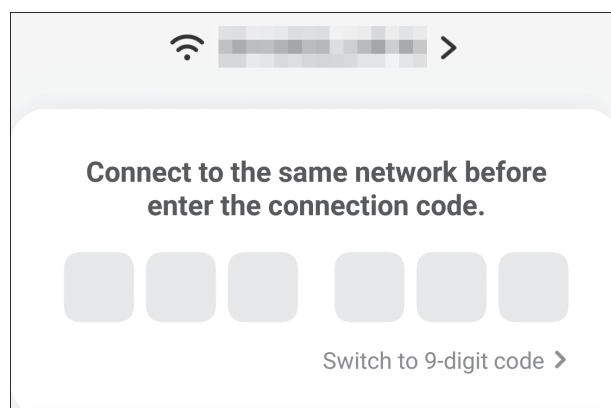

(This monitor does not support 9-digit codes.)

Bytello Share

2. Enter the connection code displayed on this monitor.

This monitor and the device are connected.

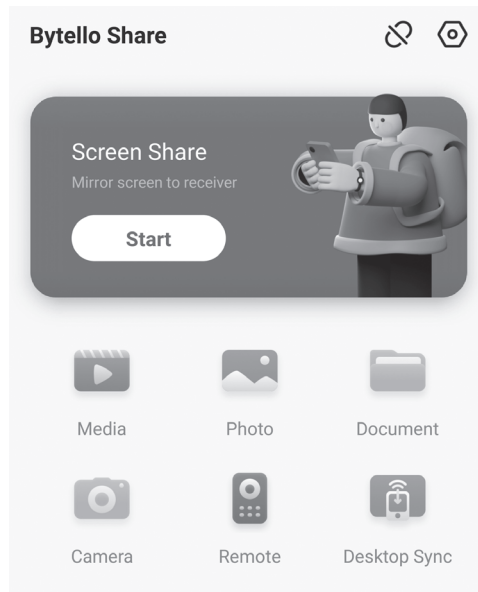

- Screen Share..... Displays the device screen.
 - Media Displays or plays back the videos and music saved in the device.
 - Photo Displays the photos and images saved in the device.
 - Document Displays the document files saved in the device.
 - Camera..... Shares the camera images on the device.
 - Remote Operates this monitor from the device.
 - Desktop Sync Displays this monitor screen on the device.
- * The tasks that can be performed vary depending on the version of the terminal (OS) and application.

■ MAKING THE SETTINGS

1. Touch “Menu” and “Settings”.

Allow this device to be discovered

Sets whether the device allows the search and connection of this monitor.

Permissions Mode

Sets whether or not to confirm on this monitor when the device transmits a screen.

Support Chromecast device

Support iOS device

Support Miracast device*

Turn ON to use.

Device Name

Changes the name of this monitor displayed on the device that transmits or receives images.

Start automatically on boot

Sets whether or not to automatically start “Bytello Share” when this monitor is turned ON.

Code refresh rate

Sets the interval to update the connection code.

Floating window size

Sets whether or not to display the connection code on a screen other than “Bytello Share”.

Normal size..... Display the connection code.

Mini size..... Display .
If you touch , the connection code is displayed.



Close Not displayed.

* Supported only by wireless LAN connection.

PDF Viewer

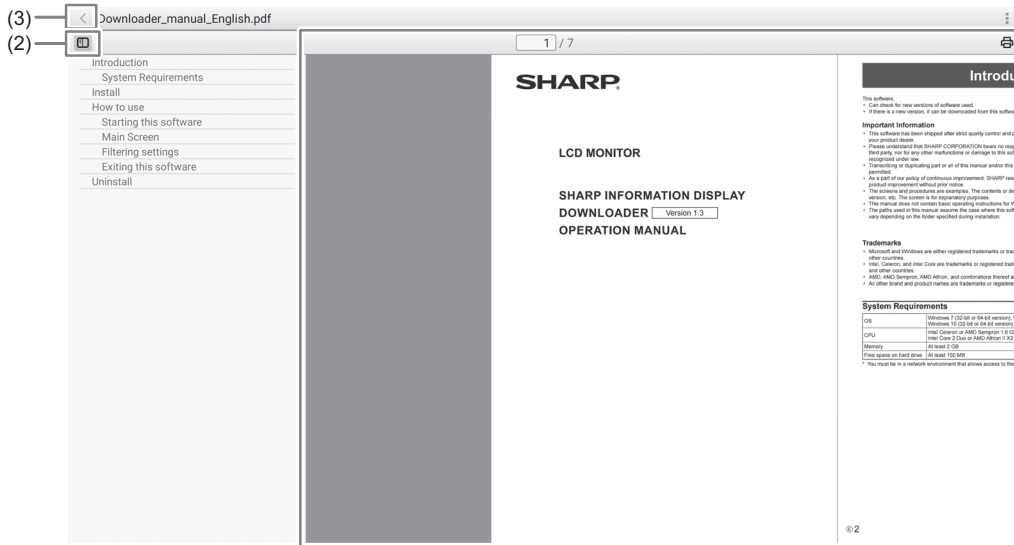
Starts when a PDF file is opened on an application such as "File Explorer", etc.

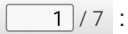

- (1) Displays the PDF.
 - Zoom-in or zoom-out the display by pinching.
 - Magnify the display by double-tap.
 -  : Displays the current page / total number of pages.
 -  : Performs printing.
- (2) Close / display the bookmark.
- (3) Exit the application.

File Explorer

Manages the files and folders in the internal storage and the USB flash drive connected to the monitor. You can also display or play back the files.

1. On the home screen of **APPLICATION** mode, touch “File Explorer”.

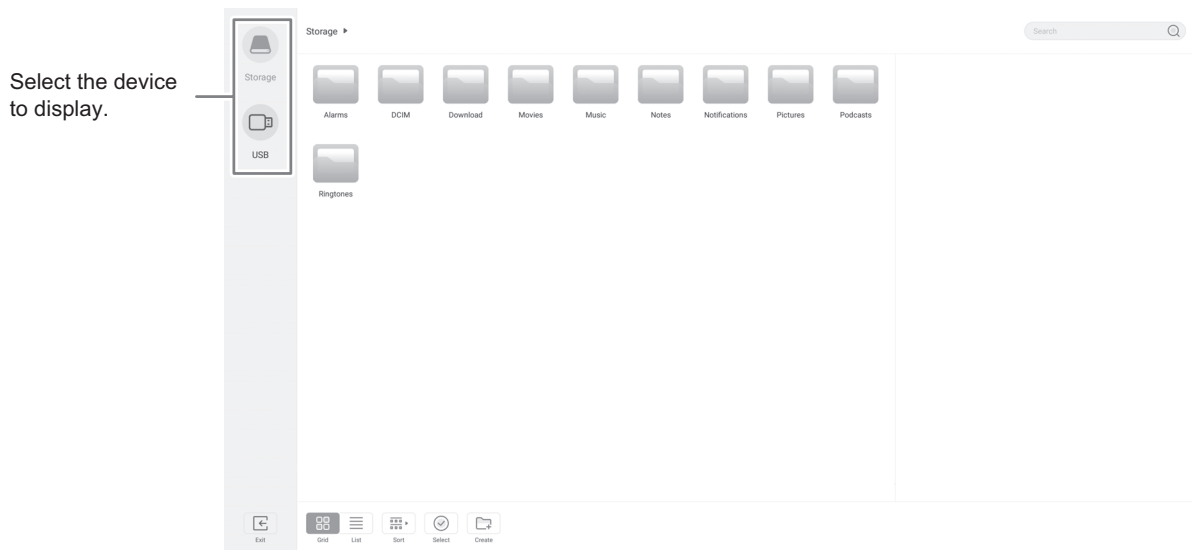

■ Creating a new folder

1. Touch “Create”.
A dialog box for the input of the folder name appears.
2. Input the folder name.
 - Up to a maximum of 255 alphanumeric characters.
3. Once input is complete, touch “OK”.

■ Copying/Moving

1. Display the file/folder to be copied/moved.
2. Touch “Select” to select the file/folder to be copied/moved.
 - You can even select multiple files/folders.
You can select all files/folders with “SelectAll”.
3. Touch “Copy” or “Cut”.
4. Display the file list of the copy/move destination.
5. Touch “Paste”.
The file/folder is copied/moved.

■ Deleting

1. Display the file/folder to be deleted.
2. Touch “Select” to select the file/folder to be deleted.
 - You can even select multiple files/folders.
You can select all files/folders with “SelectAll”.
3. Touch “Delete”.
A confirmation screen appears.
4. Touch “OK”.

■ Renaming

1. Display the file/folder to be renamed.
2. Touch “Select” to select the file/folder to be renamed.
3. Touch “Rename”.
4. Enter the new name, and then touch “OK”.

■ Exiting

1. Touch “Exit”.

■Supported formats

You can play image, music, and video files.
The types of files that can be played are as follows.

Image files

Extension	Max. resolution
*.bmp	3840x2160
.jpg (.jpeg)	
*.png	

- Progressive JPEG files are not supported.

Music files

Extension	Audio coding	Sample rate	Bit rate
*.mp3	MPEG1/2 layer3	8kHz - 48kHz	8kbps - 320kbps

Video files

Extension	Video coding	Audio coding	Max. resolution	Maximum bit rate
*.mkv	vp9 (Profile 0 (420 8bit), Profile 2 (420, 10bit))	Mpeg1/2 Layer1/2/3, AAC-LC, LPCM, opus	4096x2160@60fps	60Mbps
	VP8		1920x1080@60fps	60Mbps
	H.265 (Main/Main10 Profile, High Tier @Level 6.1)		4096x2160@60fps	200Mbps
	H.264 (BP, MP, HP @ level5.1)		3840x2160@30fps	160Mbps
	Mpeg-4 (Simple Profile, Advanced Simple, Profile@Level 5)		1920x1080@60fps	80Mbps
	mpeg1/2 (MP @HL)		1920x1080@60fps	80Mbps
*.mp4	H.265 (Main/Main10 Profile, High Tier @Level 6.1)	Mpeg1/2 Layer1/2/3, AAC-LC, vorbis, LPCM, AMR-NB	4096x2160@60fps	200Mbps
	H.264 (BP, MP, HP @ level5.1)		4096x2160@60fps	200Mbps
	Mpeg-4 (Simple Profile, Advanced Simple, Profile@Level 5)		1920x1080@60fps	80Mbps
	mpeg1/2 (MP @HL)		1920x1080@60fps	80Mbps

In some cases it may not be possible to play the above files.

Web Browser

Browses the home page.

1. On the home screen of APPLICATION mode, touch “Web Browser”.

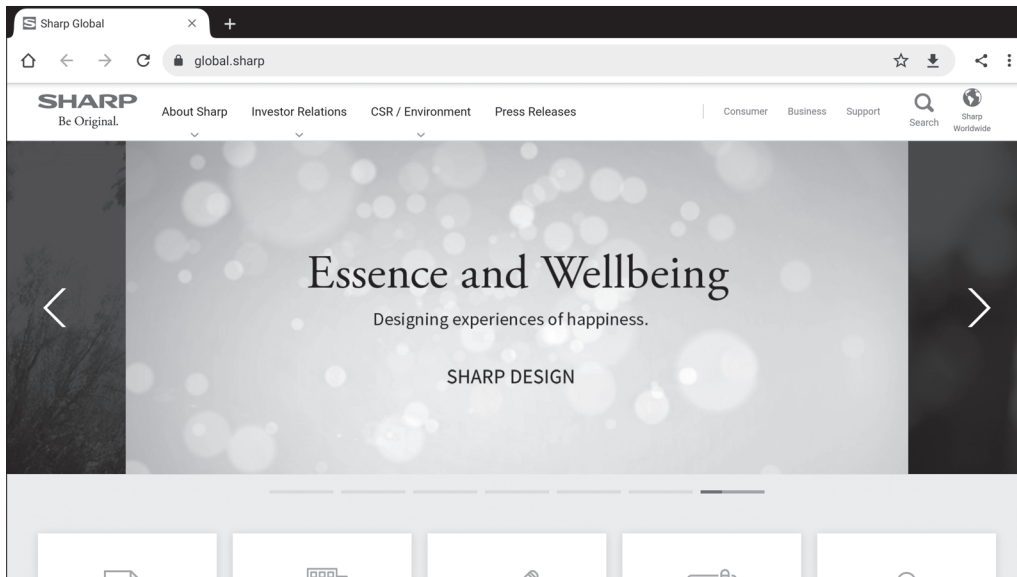

Exiting

Close the Web Browser from the recent app bar.

TIPS

- If a large-sized website is displayed, the Web Browser may close.

! Caution

- Take proper care when browsing websites.
In a malicious website, the input contents may be stolen and fraudulent applications may be downloaded.
If a fraudulent application is installed, it may result in a virus infection or stealing of communication details.
- Be sure to log out from a website that you have used by logging in.
If you remain logged in, your personal information such as the ID may be known by a third person.

Updating the Software (Update)

Update applications that are factory-installed in APPLICATION mode. (A network environment that allows access to the internet is required.)

On the home screen of APPLICATION mode, touch “All Apps”, and then touch “Updater”.

When you use Updater, a password is required. (Factory setting) (See page 45.)

The “Export Law Assurances” appears. Select “OK”.

To use the software distributed by the Updater, you must agree to the “Export Law Assurances”.

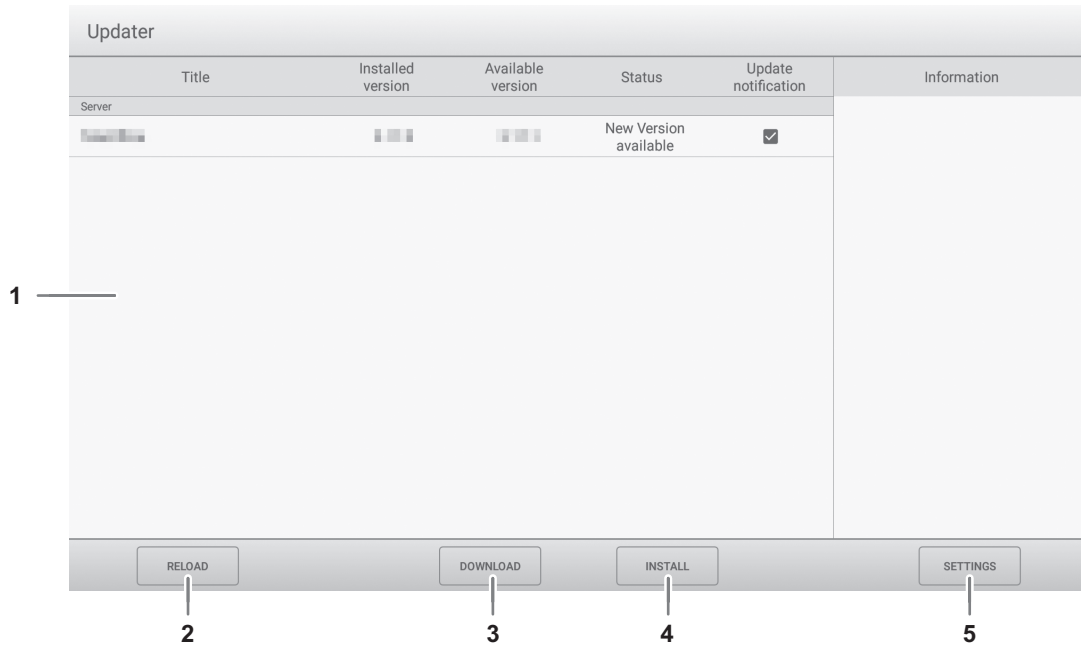

1. Information area

Shows information on already downloaded software and software that can be downloaded.

Update notification: Displayed when “Notify new versions” is set to on. Update of software that unchecked will not be notified.

2. RELOAD

Refresh the information in the information area.

3. DOWNLOAD

Download the selected software.

4. INSTALL

Install the selected software.

5. SETTINGS

Configure settings for Update.

- Hide updated items.....Set whether or not to hide updated softwares in the information area.
- Notify new versions.....Set whether or not to display a message if updated software exists.
- Scheduled installation.....Set whether or not to update the software automatically.
- Scheduled installation day.....When “Scheduled installation” is set to on, set the day of week to update the software automatically.
- Scheduled installation time.....When “Scheduled installation” is set to on, set the time to update the software automatically.
- Proxy.....Set whether or not to use this monitor in a proxy environment.
- Proxy settings.....When “Proxy” is set to on, set the host name, port, username, and password of the proxy.
- About Updater.....Display the information of this application.
- Reset.....Initialize the “SETTINGS”.

Common Settings Menu

Displaying the menu screen

Adjusts the images and sound.

! Caution

- Do not turn the main power switch off while the menu items are being displayed. Doing so may initialize the settings.

■ Example of operation

1. On the home screen of APPLICATION mode, select “Common Settings”.

Or, press the MENU button on the remote control unit.

The Common Settings menu appears.

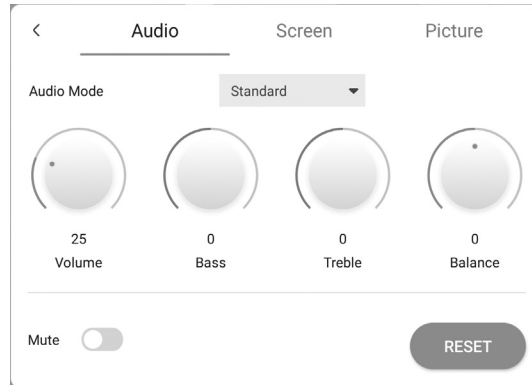

2. Select the tab and adjust each item. (See below.)

Select < to display the Input menu.

3. Once the settings are complete, touch other than the Common Settings menu.

Or, press the RETURN button on the remote control unit.

TIPS

- When press the MENU button on the remote control unit, the Common Settings menu may appear above the application's menu. Close the Common Settings menu to operate the application's menu.

Menu item details

■ Audio

Sound Mode

Selects the sound mode.

Volume

Adjusts the volume.

Bass

Adjusts the volume of bass-level sound. You can set this when the “Sound Mode” is set to “Custom”.

Treble

Adjusts the volume of treble-level sound. You can set this when the “Sound Mode” is set to “Custom”.

Balance

Adjusts the balance of the audio sound between right and left.

Mute

Sets whether or not to mute the audio.

RESET

Resets the values of the Audio menu items to the factory default settings.

■ Screen

H Position (D-SUB)

Adjust the horizontal position of the image.

V Position (D-SUB)

Adjust the vertical position of the image.

Clock (D-SUB)

Adjusts frequency for sampling clock for applicable video. Adjust when there is flickering in the form of vertical stripes. When using the adjustment pattern (see page 44), make adjustments so that no vertical stripe noise appears in it.

Phase (D-SUB)

Adjusts sampling clock phase for applicable video. Useful when small characters appear with low contrast and/or there are flickers at corners. When using the adjustment pattern (see page 44), make adjustments so that no horizontal stripe noise appears in it.

* Adjustments to "Phase" should be made only after "Clock" has been correctly set.

AUTO (D-SUB)

The "Clock", "Phase", "H Position", and "V Position" are automatically adjusted.

Executed when "AUTO" is selected. Use this automatic adjustment when you use the D-SUB to display a computer screen for the first time or when you change the setting of the computer. (See page 44.)

Size (HDMI/D-SUB/USB-C/OPS)

Changes the screen size. (See page 26.)

RESET

Resets the values of the Screen menu items to the factory default settings.

■ Picture

Color Mode (HDMI/D-SUB/USB-C/OPS)

Selects color mode for the screen.

Black Level (HDMI/D-SUB/USB-C/OPS)

Adjusts the entire brightness of the video signals. You can set this when the "Color Mode" is set to "Custom".

Contrast (HDMI/D-SUB/USB-C/OPS)

Adjusts the difference between the bright and dark portions of the image. You can set this when the "Color Mode" is set to "Custom".

White Balance

Selects the white balance.

RESET

Resets the values of the Picture menu items to the factory default settings.

Adjustments for computer screen display

■ Automatic adjustment

When you use the “D-SUB” to display a computer screen for the first time, or when you change the setting of the computer, use the automatic screen adjustment.

1. **Switch the input to “D-SUB” and display the adjustment pattern.** (See the description below.)
2. **Display the Screen menu on “Common Settings”.**
3. **Select “AUTO”.**

The automatic adjustment is complete in several seconds.

4. **Press the MENU button to close the menu screen.**

TIPS

- If the screen cannot be adjusted properly with one automatic adjustment, repeat the automatic adjustment two or three times. Try manual adjustment if necessary.

■ Screen display for adjustment

Before making adjustments in the Screen menu or Picture menu, display an image to brighten the entire screen. If you are using a Windows computer, use the adjustment pattern. Download the adjustment pattern by using Information Display Downloader.

Opening the adjustment pattern

1. **Double-click [Adj_uty.exe] downloaded.**

The adjustment pattern will appear.

Adjust the screen automatically or manually.

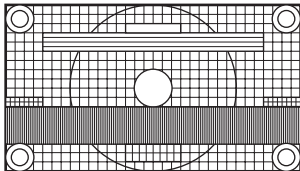

2. **When adjustment is finished, press the [Esc] on the computer’s keyboard to quit the adjustment program.**

TIPS

- If the display mode on the computer you are using is 65000 colors, the color levels in the color pattern may appear differently or grayscale may appear to be colored. (This is due to the specifications of the input signal and is not a malfunction.)

Administrator Settings Menu

Displaying the menu screen

Makes settings for this monitor.

! Caution

- Do not turn the main power switch off while the menu items are being displayed. Doing so may initialize the settings.

Touch to operate.

1. On the home screen of APPLICATION mode, touch “Administrator Settings”.

- When you use Administrator Settings, a password is required. (Factory setting)
A screen for the input of the password appears.
- When you use Administrator Settings for the first time, a Set Password screen appears. Set a password.

2. Enter the password, and then touch “OK”.

To change the password, touch “Change the admin password”.

The Administrator Settings menu appears.

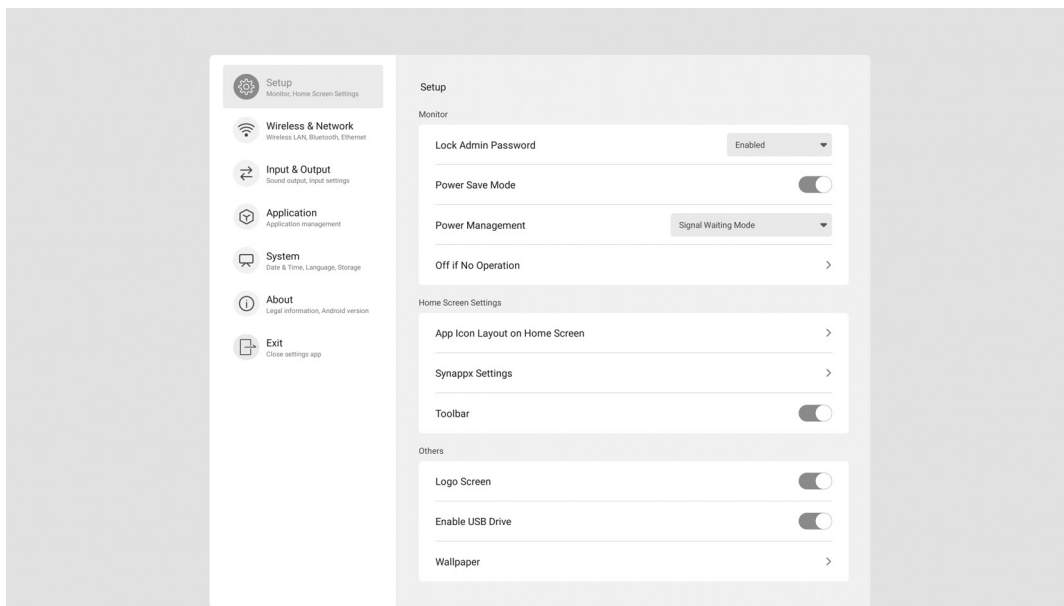

3. Set each item. (See page 46.)

4. Once the settings are complete, touch “Exit”.

Menu item details

■ Setup

Monitor

Lock Admin Password

Sets whether or not a password is necessary when using “Administrator Settings”, “FUNCTION”, and “Updater”.

Power Save Mode

When set to off, startup time from standby state is reduced. Note, however, that more power will be consumed in standby state. Android continues to run in standby state.

When set to on, standby state is standby mode. Current consumption is reduced while the monitor is in standby state.

Android is also shut down. Note, however, that the startup time from standby state becomes longer.

If set to on, certain RS-232C commands cannot be used in standby mode. (See pages 51.)

Power Management

Sets whether or not to move to input signal waiting state or standby state in the nosignal state.

Disabled Do not move.

Signal Waiting Mode Move to input signal waiting state.

Power Standby If the nosignal state continues for approximately 5 minutes, the monitor moves to the standby state. The application data that is not saved is lost.

Off if No Operation

Determines whether or not to set the monitor to go into standby state when there is no operation by the remote control unit, touch or RS-232C control.

Home Screen Settings

App Icon Layout on Home Screen

Sets the icons of the applications to be arranged on the home screen of APPLICATION mode.

Synappx Settings

Synappx Setting Sets whether or not to display the “Synappx” icon on the home screen of APPLICATION mode.

Input for Synappx When “Synappx Setting” is set to on, sets the input terminal to which the computer on which Synappx is installed is connected.

Toolbar

Sets whether or not to display the toolbar.

Others

Logo Screen

Sets whether or not to display the logo screen when turning the power on.

Enable USB Drive

Sets whether or not to allow the use of a USB flash drive.

Wallpaper

Sets the background of the home screen of APPLICATION mode.

■ Wireless & Network

Wireless & Network

Wireless LAN

Sets whether or not to use a wireless LAN when installing a wireless adapter. To use a wireless LAN, set the access points.

You cannot use the “Ethernet” when using a “Wireless LAN”.

Ethernet

Sets whether or not to use a LAN terminal.

To use a LAN terminal, set the IP address, etc. You cannot use a “Wireless LAN” when using the “Ethernet”.

Bluetooth

Set whether or not to use a commercially available Bluetooth device.

Configure settings for Bluetooth.

■ Input & Output

Sound

Audio Output

Sets the volume of sound output from the audio output terminal.

Variable1 You can adjust the volume from the speakers of this monitor and the audio output terminal simultaneously by using "Volume".

Variable2 You can adjust the volume from the audio output terminal by using "Volume".
Sound will not be output from the speakers of this monitor.

Fixed Fixes the volume from the audio output terminal. Adjust the volume by using an external device.

Mute with Freeze

Set whether or not audio turns off during freeze.

Input Settings

Auto Input Change

Sets whether the input into the input terminal automatically changes when a video signal is input into that terminal. The input via the expansion slot is ignored. (With some input signals, the input may not change.)

Input Mode Name

For each terminal, you can change the input mode name that is displayed during input mode selection or display.

External Source Display Settings

CEC Settings

Makes settings for linkage with devices connected to HDMI1 input terminal through HDMI CEC.

HDMI CEC Link

When this setting is set to on, the link will be used.

When this setting is set to off, the link will not be used.

Auto Power On..... When "HDMI CEC Link" is set to on, sets whether or not to turn this monitor ON by linking to the operation of the devices.

HDMI Modes

"HDMI Modes" settings change how the content displayed is processed and decoded using the HDMI input terminal.

Mode1 Normally used.

This will support most common color spaces and other encoding signals.

Mode2 Used when proper display cannot be performed in "Mode1", such as when a device that is not compatible with 4K is connected.

■ Application

Manages the installed applications.

■ System

Date & Time

Use 24-Hour Format

Sets whether or not to display the time in the 24-hour format.

Automatic Date & Time

Sets whether or not to set the data & time automatically via network.

Set Date

Sets the date. Displayed when "Automatic Date & Time" is set to off.

Set Time

Sets the time. Displayed when "Automatic Date & Time" is set to off.

Date format

Sets the display format for the date.

Time Zone

Sets the time zone.

Administrator Settings Menu

Language & Keyboard

Language

Sets the display language for the screen.

Virtual Keyboard

Selects the keyboard to display on the screen.

Physical Keyboard

Displays information about the physical keyboard used.

Current Keyboard

Sets the language for the physical keyboard being used.

Show Virtual Keyboard..... Sets whether or not to display a keyboard on the screen when a physical keyboard is connected.

Startup & Shutdown

Start Input Mode

You can set the input mode that will be in effect when the power is turned on.

When this is set to "Last Input Mode", the input mode when the power was last turned off will appear.

* When "Auto Input Change" is set to on and there is no input signal in the set input mode, the input mode changes to APPLICATION mode.

Startup App

When "Start Input Mode" is set to "APPLICATION", sets the applications to be started automatically.

Sleep After Startup

Sets whether or not to move to sleep state (backlight off) after startup.

Power Off Reminder

Sets whether or not to display a confirmation message when the power off schedule is executed.

Add Power On Schedule

Power can be turned ON at the specified time.

Add Power Off Schedule

Power can be turned OFF at the specified time.

Storage

Displays the capacity of the internal storage of this monitor and the external storage connected to this monitor.

System Update

Confirms the firmware version and updates the firmware.

Current Version

Displays the current firmware version.

Update

If you connect the USB flash drive containing the firmware to this monitor and then touch "Check", the firmware will be updated.

Security

Trusted Credentials

Displays the trusted credentials.

User Credentials

Displays the user credentials.

Install From Storage

Installs a file from the connected storage.

Clear credentials

Deletes all credentials.

■ About

Displays the information of the monitor.

■ Schedule

You can set the time to switch the monitor on and off.
Set this function with “Startup & Shutdown” in the System menu. (See page 48.)

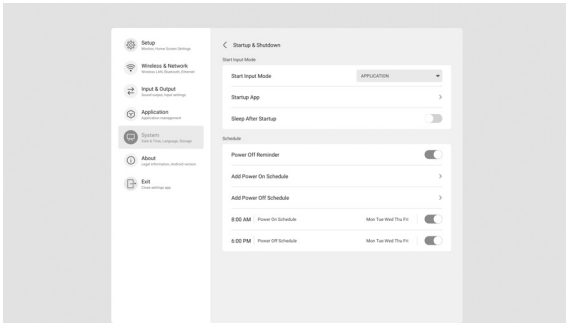

1. To turn the power ON at the specified time, touch “Add Power On Schedule”.
To turn the power OFF at the specified time, touch “Add Power Off Schedule”.
2. Set the time and day of implementation.
3. Touch “Save”.
The schedule is displayed as a list.
4. Turn on the schedule.
You can also turn off the schedule.

! Caution

- Do not switch off the main power after setting the schedule.
- Specify the correct date and time. (See page 47.)
Schedule does not function unless the date and time are specified.
- Check regularly that the set date and time are correct.
- In the power off schedule, a message is displayed on the screen approx. 1 minute before the power turns off. If you select “Cancel”, you can stop the power from turning off. (When “Power Off Reminder” is set to on.)
- The power on schedule and power off schedule must be set at an interval of 5 minutes or more.

TIPS

- Up to 14 “Schedule” items can be registered.

Reset/Functional Restriction Setting (FUNCTION Menu)

You can reset the settings to the factory default settings or restrict operations. When you use FUNCTION menu, a password is required. (Factory setting) (See page 45.)

Perform the operation from the remote control unit.

1. Press the FUNCTION button, and then press the MENU button within 10 seconds.

The FUNCTION menu appears.

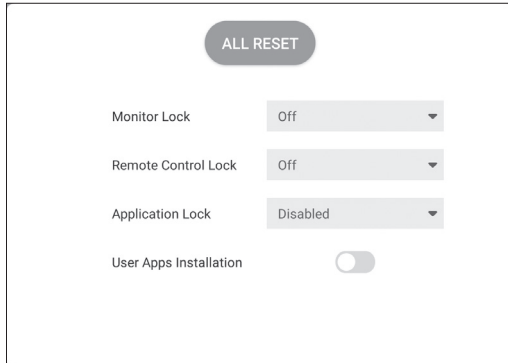

2. Select and set the items.

ALL RESET

Resets the settings to the factory default settings. In "APPLICATION" mode, only the settings of the factory-installed applications are initialized. If you select "ALL RESET", a confirmation message is displayed. Select "All Reset". This monitor restarts when initialization ends.

Monitor Lock

You can disable operations on the monitor that use buttons.

Off:

Enables operation.

Power Button:

Locks Power Button operation.

Touch:

Locks touch operation.

Power Button & Touch:

Locks Power button and touch operation.

Remote Control Lock

You can disable operations on the remote control unit that use buttons.

Off:

Enables operation.

All:

Locks all button operations.

Except Power & Volume:

Locks operations other than power operation and VOLUME +/-.

Application Lock

Sets whether or not to lock the use of the following application.

- Updater
- Synappx
- Bytello Share
- Web Browser

User Apps Installation

Sets whether or not to allow the installation of applications by the apk file.

Closing the FUNCTION menu

- Press the MENU button or RETURN button on the remote control unit.
- Touch other than the FUNCTION menu.

! Caution

- Applications installed by customers are out of scope of guarantee.
- Check the safety of applications. Some applications may affect the operation of other applications and this monitor. Also, there is a possibility of a virus infection, data corruption, falsification, or leakage.

Controlling the Monitor with a computer (RS-232C)

You can control this monitor from a computer via RS-232C (COM port) on the computer.

Computer connection

Connect with RS-232 straight cable between the computer's COM port (RS-232C connector) and the RS-232C input terminal on the monitor.

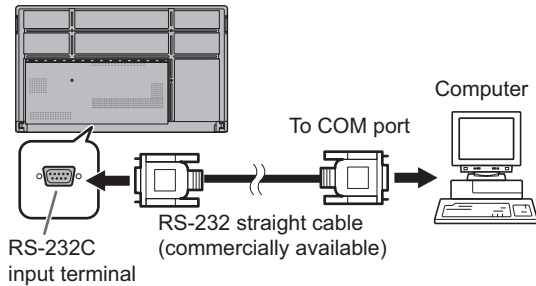

Communication conditions

Set the RS-232C communication settings on the computer to match the monitor's communication settings as follows:

Baud rate	9600 bps
Data length	8 bits
Parity bit	None

Stop bit	1 bit
Flow control	None

Communication procedure

Command format

When a command is sent from the computer to the monitor, the monitor operates according to the received command and sends a response message to the computer.

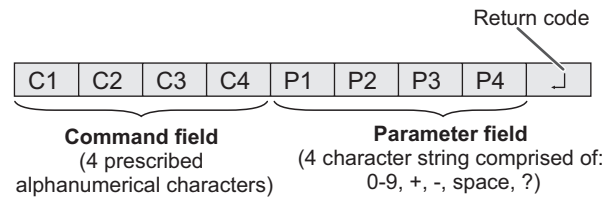

Example: VOLM0030
VOLM _ _ 30

- * Be sure to input 4 characters for the parameter. Pad with spaces (" ") if necessary. (" " is a return code (0DH, 0AH or 0DH))
Wrong : VOLM30
Right : VOLM _ _ 30

When inputting a negative value, specify a numerical value in three digits.

Example: OFSR-127

When the parameter part is 5 or more characters, specify parameters using a specified number of characters without using spaces.

Example: MPOS010097

If a command has "R" listed for "Direction" in the "RS-232C command table" on page 53, the current value can be returned by using "?" as the parameter.

Example:

VOLM ? ? ? ← From computer to monitor (How much is current volume setting?).

30 ← From monitor to computer (Current volume setting: 30).

Controlling the Monitor with a computer (RS-232C)

■Response code format

When a command has been executed correctly

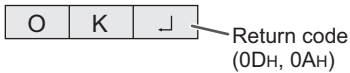

A response is returned after a command is executed.

When a command has not been executed

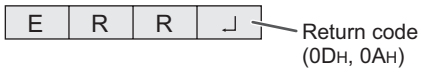

TIPS

- "ERR" is returned when there is no relevant command or when the command cannot be used in the current state of the monitor.
- If communication has not been established for reasons such as a bad connection between the computer and monitor, nothing is returned (not even ERR).
- "ERR" may be returned when a command cannot be received correctly due to interference from the surrounding environment. Please ensure that the system or software resends the command if this occurs.

If execution of the command is taking some time

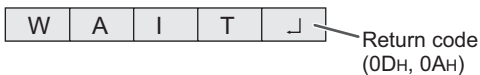

When the following commands are used, "WAIT" is returned. In this case, a value will be returned if you wait a while. Do not send any command during this period.

- Commands which return "WAIT":
RSET, POWR, INPS, ASNC, BOMD, WIDE

■Communication interval

- After "OK" or "ERR" is returned, you must send the following commands.
To set a timeout for the command response, specify 10 seconds or longer.
- Provide an interval of 100 ms or more between the command response and the transmission of the next command.

VOLM0020
OK

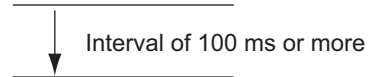

INPS0001
WAIT
OK

TIPS

- When "ALL RESET" is executed, this monitor will restart. Wait at least 1 minute before sending the next command.
- Before sending a power "On" or "Off" command, it is recommended that you perform buffer clear at the sending application side.
- After executing a power "On" or "Off" command, wait at least 1 minute before sending the next command.

RS-232C command table

How to read the command table

- Command: Command field (See page 51.)
- Direction: W When the "Parameter" is set in the parameter field (see page 51), the command functions as described under "Control/Response Contents".
 R The returned value indicated under "Reply" can be obtained by setting "???" or "???" in the parameter field. (See page 51.)
- Parameter: Parameter field (See page 51.)
- Reply: Response (Returned value)
- * : "●" : Indicates a command which can be used in standby state, input signal waiting state or when the power is on.
 "○" : Indicates a command which can be used in input signal waiting state or when the power is on.
 "△" : Indicates a command which can be used in standby state or when power is on.
 "—" : Indicates a command which can be used when the power is on.

Power control/Input mode selection

Function	Command	Direction	Parameter	Reply	Control/Response contents	*	
Power control	POWR	W	0		Switches to standby state.	●	
			1		Returns from standby state.		
		R		0			Standby state
				1			Normal mode
				2			Input signal waiting state
Input mode selection	INPS	W	0		Toggle change for input mode.	○	
		WR		2			D-SUB
				10			HDMI1
				13			HDMI2
				18			HDMI3
				21			OPTION
				24			APPLICATION
				27			USB-C

Common Settings menu

Function	Command	Direction	Parameter	Reply	Control/Response contents	*
Volume	VOLM	WR	0-100	0-100		-
Mute	MUTE	WR	0-1	0-1	0: Off, 1: On	
Size (Screen size selection)	WIDE	WR	1-3	1-3	1: Wide, 2: Normal, 3: Dot by Dot	
Auto	ASNC	W	1		When the input mode is D-SUB.	
Color Mode	BMOD	WR	0	0	Standard	
			4	4	High Illuminance	
			8	8	Custom	
White balance	WHBL	WR	0-3	0-3	0:Thru, 1:Standard, 2:Warm, 3:Lamp	

Administrator Settings menu

Function	Command	Direction	Parameter	Reply	Control/Response contents	*
Date & Time Settings	DATE	WR	AABBCCDDEE	AABBCCDDEE	AA: Year, BB: Month, CC: Day, DD: Hour, EE: Minute	-
Model	INF1	R		Value		△
Serial no.	SRNO	R		Value		

Controlling the Monitor with a computer (RS-232C)

Function menu

Function	Command	Direction	Parameter	Reply	Control/Response contents	*
Monitor Lock	ALCM	WR	0-3	0-3	0: Off, 1: Power Button & Touch, 2: Power Button, 3: Touch	
Remote Control Lock	ALCR	WR	0-2	0-2	0: Off, 1: All, 2: Except Power & Volume	-
All Reset	RSET	W	0		0: All Reset	

Others

Function	Command	Direction	Parameter	Reply	Control/Response contents	*
Bright	VLMP	WR	0-100	0-100		-
Temperature sensor	DSTA	R		0	Internal temperature normal	●
				1	Internal temperature abnormal has occurred and the monitor is in standby state	
				2	Internal temperature abnormal occurred (To delete the information of temperature abnormal, turn off the main power.)	
				3	Internal temperature abnormal has occurred and backlight brightness is dimmed	
				4	Temperature sensor abnormal	
Temperature acquisition	ERRT	R		Value	Returns the temperature at the temperature sensors. Indicates a temperature sensor abnormality when "126" is returned.	
Check the resolution	PXCK	R		-	Returns current resolution in the form of hhh, vvv.	
Sleep (Backlight off)	BOMD	W	0		Move to Sleep (Backlight off) state	-
					Returns from Sleep (Backlight off) state	
		R		0	Sleep (Backlight off) state	
				1	Normal operation (Backlight on) state	

Troubleshooting

If you are experiencing any problem with your display, before calling for service, please review the following troubleshooting tips.

There is no picture or sound.

- The power LED is off.
 - Is power supplied to this monitor?
 - Is the power cord disconnected? (See page 14.)
 - Is the main power switch off? (See page 18.)
- The power LED lights orange.
 - This monitor is in standby state. Turn on the power. (See page 18.)
- The power LED flashes blue.
 - There is no input signal.
 - Is an input mode selected that is appropriate for the input terminal to which the cable is connected? (See page 25.)
 - If any external equipment is connected, make sure the equipment is operating (playing back).

Remote control does not work.

- Are the batteries inserted with polarity (+,-) aligned? (See page 15.)
- Are the batteries exhausted?
- Point the remote control unit toward the monitor's remote control sensor. (See page 15.)
- Is operation disabled? (See page 50.)

The remote control unit's buttons for operating the HDMI-connected device do not work.

- Is the device connected to the HDMI1 input terminal? HDMI2 input terminal and HDMI3 input terminal are not supported.
- When the input mode is APPLICATION, these buttons operate the application in APPLICATION mode.
- Is "HDMI CEC Link" set to on of "CEC Settings" on the "Input & Output" menu?
- Switch to a different input mode, and then try switching the input mode back to "HDMI1".

Sound from left and right speakers is reversed.

Sound is heard from only one side.

- Are audio cables connected properly?
- Check the setting of "Balance" from the Audio menu. (See page 42.)

There is a picture but no sound.

- Is the sound muted?
- Make sure the volume is not set to minimum.
- Are audio cables connected properly?
- Is the setting of "Audio Output" of "Sound" on the Input & Output menu correct?

Unstable video.

- The signal may be incompatible.
- Try the automatic screen adjustment when "D-SUB" is in use.

The video from the HDMI input terminal does not appear properly.

- Does the HDMI cable support 4K, and is it HDMI standard compliant? The monitor will not work with cables that are not standard compliant.
- Is the input signal compatible with this monitor? (See pages 59 and 60.)
- If the connected device does not support 4K, set "HDMI Modes" to "Mode2".

The video from D-Sub input terminal does not appear correctly.

- Is the input signal compatible with this monitor? (See page 59.)

The video from the USB Type-C does not appear properly.

- Is the input signal compatible with this monitor? (See page 59 and 60.)

Control buttons do not work.

There is no picture.

- Load noises from outside may be interfering with normal operation. Turn off the main power and turn it on after waiting at least 5 seconds, and then check the operation.

The input mode changes automatically.

- When "Auto Input Change" is on, the input mode automatically changes to that terminal when a video signal is input into the input terminal.
For this reason, the input mode may change when the computer wakes up from system standby.

The touch panel does not respond.

- Is the USB cable connected properly?

Troubleshooting

**The response of the touch panel is slow.
Some parts of the screen do not respond.
A different place is touched.**

- Is the screen exposed to direct sunlight or other strong light? The touch panel uses infrared rays and thus may not operate correctly.
- Is there an obstacle between the infrared transmitter/receiver and the touch pen or your finger? An obstacle will prevent correct operation. If your fingers or a sleeve are too close to the screen, correct operation will not be possible.
- Is the infrared transmitter/receiver dirty? Gently wipe off any dirt with a soft cloth.
- If the touch panel is touched with a small tip less than about 1/16 inch (2 mm) x 1/16 inch (2 mm), the touch may not be detected by infrared and correct operation will not take place.
- Do not touch the touch panel when turning on the monitor. If you touch the touch panel, this may be detected as an element failure in the infrared transmitter/receiver and incorrect operation will result.
- Set the screen size to "Wide". (See page 26.)

When "AUTO DIMMING" is displayed.

- When the internal temperature of the monitor rises excessively, the brightness of the backlight automatically decreases in order to prevent a further temperature rise. If you attempt to adjust the brightness while the monitor is in this state, "AUTO DIMMING" is displayed and you cannot change the brightness.
- Remove the cause of the excessive temperature rise.

The monitor makes a cracking sound.

- You may occasionally hear a cracking sound from the monitor. This happens when the cabinet slightly expands and contracts according to change in temperature. This does not affect the monitor's performance.

**Power LED is flashing in orange and blue alternately.
When "TEMPERATURE" is displayed in the corner of the screen.**

- When the internal temperature of the monitor rises excessively, the brightness of the backlight decreases automatically in order to prevent high-temperature-related problems. When this occurs, "TEMPERATURE" is displayed on the screen and the Power LED flashes orange and blue alternately.
- If the internal temperature rises further, the monitor automatically enters standby state. (The Power LED lighting orange.)
- Remove the cause of the excessive temperature rise.
 - If the monitor enters standby state due to a rise in temperature, to return to normal display, turn the power switch off and then back on again. The monitor, however, will enter standby state again if the cause of the temperature rise is not eliminated.
 - Check whether the monitor is placed at a location where a quick rise in temperature is likely. Internal temperature rises quickly if the vents on the monitor are blocked.
 - Internal temperature rises quickly if dust accumulates inside the monitor or around the vents. Remove dust if possible. Ask SHARP dealer about removing internal dust.

No sound is heard from the speaker.

Mic cannot be used.

Web camera cannot be used.

- Check if another device is connected via the USB or Bluetooth.
- If more than one equivalent devices are connected, they will be used in the following order:
Bluetooth > USB > Internal (speaker only)
- Remove unnecessary devices.
- The mic of the Bluetooth headset cannot be used. This monitor does not support HSP/HFP.

Specifications

■Product Specifications

Model	PN-L862B	PN-L752B	PN-L652B
LCD component	86" Class [85-9/16 inch (217.4 cm) diagonal] TFT LCD	75" Class [74-1/2 inch (189.3 cm) diagonal] TFT LCD	65" Class [64-1/2 inch (163.9 cm) diagonal] TFT LCD
Max. resolution (pixels)	3840 x 2160		
Max. colors	Approx. 1.07 billion colors		
Pixel pitch	0.4935 mm (H) × 0.4935 mm (V)	0.42975 mm (H) × 0.42975 mm (V)	0.372 mm (H) × 0.372 mm (V)
Brightness (typical)	400 cd/m ² *1		
Contrast ratio (typical)	1200: 1	5000: 1	4000: 1
Viewing angle	178° right/left/up/down (contrast ratio ≥ 10)		
Screen active area inch (mm)	74-5/8 (W) x 41-15/16 (H) (1895.0 x 1066.0)	64-15/16 (W) x 36-9/16 (H) (1650.2 x 928.3)	56-1/4 (W) x 31-5/8 (H) (1428.5 x 803.5)
Computer input signal	Analog RGB (0.7 Vp-p) [75 Ω]		
Sync signal	Horizontal/vertical separate (TTL: positive/negative)		
Plug and play	VESA DDC2B		
Input terminals	Video	Mini D-sub 15 pin, 3 rows x 1 HDMI x 3 USB Type-C x 1	
	Serial (RS-232C)	D-sub 9 pin x 1	
	Audio	3.5 mm mini stereo jack x 1	
Output terminals	Audio	3.5 mm mini stereo jack x 1 Digital audio output (optical) x 1	
	USB port	USB 3.0 compliant x 4, USB 2.0 compliant x 1	
LAN terminal	10 BASE-T/100 BASE-TX/1000 BASE-T		
System	OS	Android 9.0	
	CPU	Arm Cortex-A73 processor (Quad-Core)	
	Memory	4GB	
	Storage	32GB	
Wireless LAN	IEEE802.11ax/ac/n/a/g/b compliant		
Bluetooth	5.0 compliant Supported protocols: A2DP, AVRCP, GATT, HID		
Expansion slot	20 V, 3.25 A (power supplied when expanding the functions with an optional part)		
Speaker output	10 W + 10 W		
Touch Panel	Detection method	Infrared blocking detection method	
	Computer connector	USB (3.0 compliant) (Type B) x 2	
Power requirement	AC 100 - 240 V, 5.3 A, 50/60 Hz	AC 100 - 240 V, 4.6 A, 50/60 Hz	AC 100 - 240 V, 3.7 A, 50/60 Hz
Operating temperature *2 *3	41°F to 95°F (5°C to 35°C)		
Operating humidity *3	20% to 80% (no condensation)		
Power consumption (input signal waiting state / standby mode *4 / off mode)	470W (20W/0.5W/0.0W)	400W (20W/0.5W/0.0W)	330W (20W/0.5W/0.0W)
Dimensions inch (mm) (excluding protrusions)	Approx. 77-1/16 (W) x 3-3/8 (D) x 45-5/8 (H) (1957 x 85.7 x 1159.5)	Approx. 67-5/16 (W) x 3-3/8 (D) x 40-1/8 (H) (1709.4 x 85.7x 1019.8)	Approx. 58-5/8 (W) x 3-3/8 (D) x 35-5/16 (H) (1488.4 x 85.5 x 896.6)
Weight lbs. (kg)	Approx. 137.8 (62.5)	Approx. 109.1 (49.5)	Approx. 80.5 (36.5)

*1 Brightness will depend on input mode and other picture settings. Brightness level will decrease over time. Due to the nature of the equipment, it is not possible to precisely maintain a constant level of brightness. This is the brightness of the LCD panel, not the brightness of the product.

*2 Temperature condition may change when using the monitor together with the optional equipments recommended by SHARP. In such cases, please check the temperature condition specified by the optional equipments.

*3 In addition, check the requirements of the computer and other devices to be connected, and make sure that all requirements are satisfied.

*4 When no optional part is attached.

As a part of our policy of continuous improvement, SHARP reserves the right to make design and specification changes for product improvement without prior notice. The performance specification figures indicated are nominal values of production units. There may be some deviations from these values in individual units.

Specifications

■ Dimensional Drawings

Note that the values shown are approximate values.

[PN-L862B]

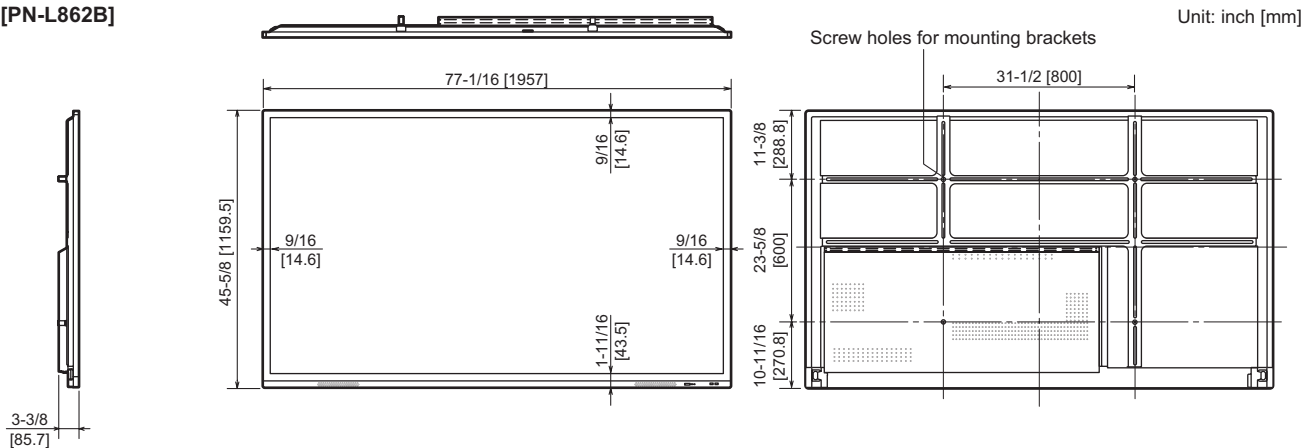

[PN-L752B]

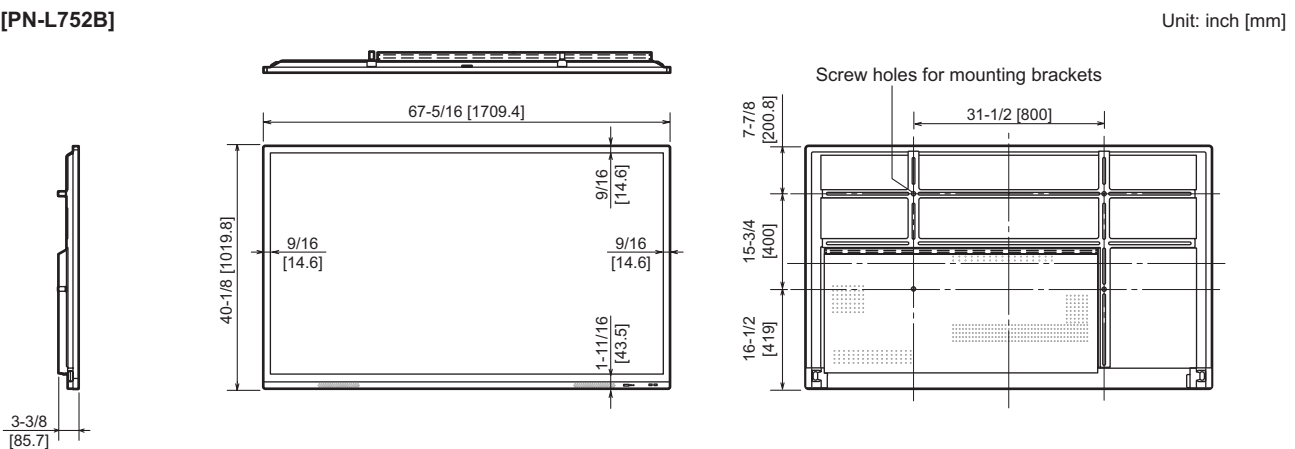

[PN-L652B]

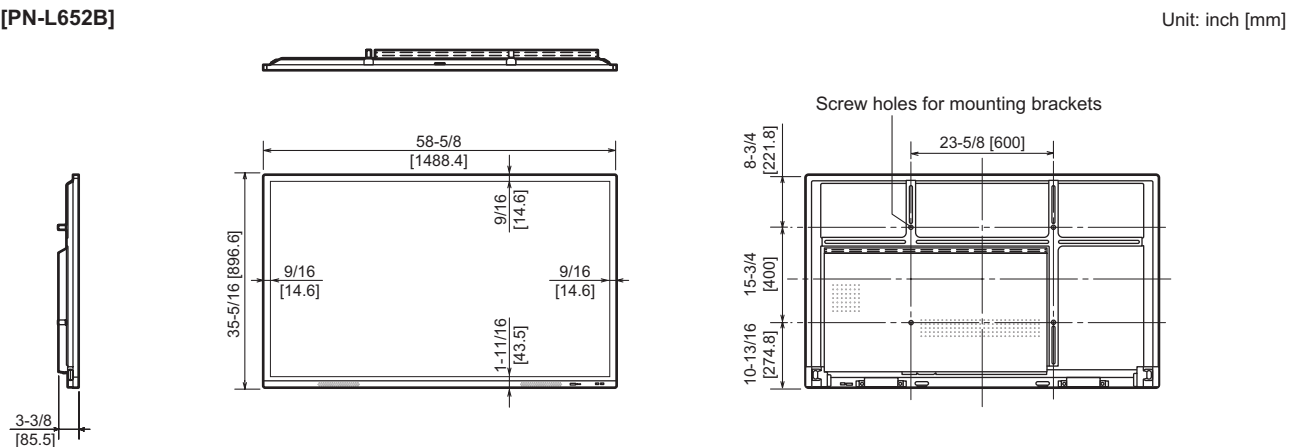

When mounting the monitor, be sure to use a wall-mount bracket that complies with the VESA-compatible mounting method. SHARP recommends using M8 screws and tighten the screws. Note that screw hole depth of the monitor is 1/2 inch (12 mm). Loose mounting may cause the product to fall, resulting in serious personal injuries as well as damage to the product. The screw and hole should come together with over 3/8 inch (10 mm) length of thread. Use a bracket which has been approved for UL1678 standard, and which can endure at least 4 times or more the weight of the monitor.

■Compatible signal timing (PC)

Screen resolution		Hsync	Vsync	Dot frequency	Digital		Analog	
					HDMI	USB-C (DisplayPort)	D-SUB	
VESA	640 × 480	31.5kHz	60Hz	25.175MHz	Yes	Yes	Yes	
	800 × 600	37.9kHz	60Hz	40.0MHz	Yes	Yes	Yes	
	1024 × 768	48.4kHz	60Hz	65.0MHz	Yes	Yes	Yes	
	1280 × 960	60.0kHz	60Hz	108.0MHz	Yes	Yes	Yes	
	1280 × 1024	64.0kHz	60Hz	108.0MHz	Yes	Yes	Yes	
	1360 × 768	47.7kHz	60Hz	85.5MHz	Yes	Yes	Yes	
	1440 × 900	55.9kHz	60Hz	106.5MHz	Yes	Yes	Yes	
Wide	1680 × 1050	65.3kHz	60Hz	146.25MHz	Yes	Yes	Yes	
	1280 × 720	44.7kHz	60Hz	74.4MHz	Yes	Yes	Yes	
	1920 × 1080	67.5kHz	60Hz	148.5MHz	Yes	Yes	Yes	
		3840 × 2160	54.0kHz	24Hz	297.0MHz	Yes	Yes	-
			56.25kHz	25Hz	297.0MHz	Yes	Yes	-
			67.5kHz	30Hz	297.0MHz	Yes	Yes	-
			112.5kHz	50Hz	594.0MHz	Yes	Yes	-
	135.0kHz	60Hz	594.0MHz	Yes	Yes	-		
	4096 × 2160	54.0kHz	24Hz	297.0MHz	Yes	Yes	-	
		56.0kHz	25Hz	297.0MHz	Yes	Yes	-	
		67.0kHz	30Hz	297.0MHz	Yes	Yes	-	
		112.5kHz	50Hz	594.0MHz	Yes	Yes	-	
		135.0kHz	60Hz	594.0MHz	Yes	Yes	-	
	US TEXT	720 × 400	31.5kHz	70Hz	28.3MHz	Yes	Yes	Yes

- Depending on the connected computer, images may not be displayed properly even if the compatible signal described above is input.

Specifications

■Compatible signal timing (AV)

Screen resolution	Frequency	HDMI	USB-C
4096 × 2160p	24Hz	Yes	
	25Hz	Yes	
	30Hz	Yes	
	50Hz	Yes	
	59.94Hz	Yes	
	60Hz	Yes	
3840 × 2160p	24Hz	Yes	
	25Hz	Yes	
	30Hz	Yes	
	50Hz	Yes	
	59.94Hz	Yes	
	60Hz	Yes	
1920 × 1080p	24Hz	Yes	
	50Hz	Yes	
	59.94Hz	Yes	
	60Hz	Yes	
1920 × 1080i	50Hz	Yes	
	59.94Hz	Yes	
	60Hz	Yes	
1280 × 720p	50Hz	Yes	
	59.94Hz	Yes	
	60Hz	Yes	
720 × 576p	50Hz	Yes	
720 × 480p	59.94Hz	Yes	
	60Hz	Yes	
640 × 480p(VGA)	59.94Hz	Yes	
	60Hz	Yes	
720(1440) × 576i	50Hz	Yes	
720(1440) × 480i	59.94Hz	Yes	
	60Hz	Yes	

■DDC (plug and play)

The monitor supports the VESA DDC (Display Data Channel) standard.

DDC is a signal standard for plug and play between monitors and computers. Information about resolution and other parameters is exchanged between the two. This function can be used if the computer supports DDC and it has been configured to detect plug-and-play monitors.

There are several types of DDC, depending on the communication method used. This monitor supports DDC2B.

■ Channels that can be used in wireless LAN

Standard	Channel	Frequency band (center frequency)
IEEE802.11ax/n/g/b	1-11ch	2412-2462MHz
IEEE802.11ax/ac/n/a	36/40/44/48ch	5180-5240MHz
	52/56/60/64ch	5260-5320MHz
	100/104/108/112/116ch	5500-5580MHz
	132/136/140ch	5660-5700MHz
	149/153/157/161ch	5745-5805MHz
	165ch	5825MHz

This device is restricted to indoor use due to its operation in the 5.15 GHz to 5.25 GHz frequency range. FCC requires this product to be used indoors for frequency range 5.15 GHz to 5.25 GHz to reduce the potential for harmful interference to co-channel Mobile Satellite systems. High power radars are allocated as primary users of the 5.25 GHz to 5.35 GHz and 5.65 GHz to 5.85 GHz bands. These radar stations can cause interference with and/or damage this device.

Intellectual Property Rights and Other Matters

■ Information on the software license for this product

Software composition

The software included in this product is comprised of various software components whose individual copyrights are held by SHARP or by third parties.

Software developed by SHARP and open source software

The copyrights for the software components and various relevant documents included with this product that were developed or written by SHARP are owned by SHARP and are protected by the Copyright Act, international treaties, and other relevant laws. This product also makes use of freely distributed software and software components whose copyrights are held by third parties. These include software components covered by a GNU General Public License (hereafter GPL), a GNU Lesser General Public License (hereafter LGPL) or other license agreement.

Obtaining source code

Some of the open source software licensors require the distributor to provide the source code with the executable software components. GPL and LGPL include similar requirements. For information on obtaining the source code for the open source software and for obtaining the GPL, LGPL, and other license agreement information, visit the following website:

https://jp.sharp/business/lcd-display/support/download/source_e.html

We are unable to answer any questions about the source code for the open source software. The source code for the software components whose copyrights are held by SHARP is not distributed.

Mounting Precautions (For SHARP dealers and service engineers)

- When installing, removing or moving the monitor, ensure that this is carried out by at least 4 people. (PN-L652B: at least 2 people.)
- Be sure to use a wall-mount bracket designed or designated for mounting the monitor.
- This monitor is designed to be installed on a concrete wall or pillar. Reinforced work might be necessary for some materials such as plaster / thin plastic board / wood before starting installation.
- This monitor and bracket must be installed on a wall which can endure at least 4 times or more the weight of the monitor. Install by the most suitable method for the material and the structure.
- To attach a VESA-compliant mounting bracket, use M8 screws that are 3/8 inch (10 mm) to 1/2 inch (12 mm) longer than the thickness of the mounting bracket.

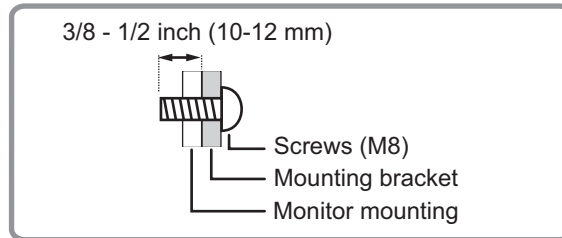

- Do not use an impact driver.
- When moving the monitor, be sure to hold the areas shown in the figure below. Do not grasp the screen. This may cause product damage, failure, or injury.

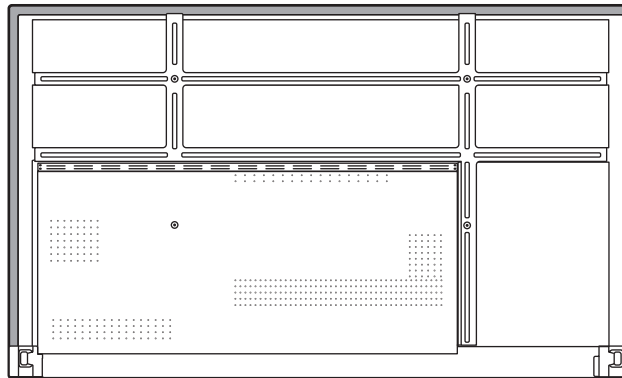

- If you need to temporarily place the monitor on a table or other surface during installation, spread a thick soft cloth on the table to prevent damage to the screen and table.
- After mounting, please carefully ensure the monitor is secure, and not able to come loose from the wall or mount.
- Do not use any screw holes other than those for mounting brackets, located on the rear of the monitor, for installation.

■ Attaching player mount

Attach the player mount when installing an optional controller.

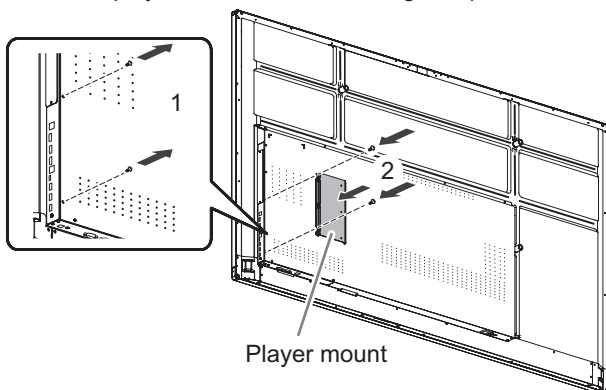

1. Remove the screws from this monitor.
2. Attach the player mount with the player mount screws (M3x6) (supplied) (x2).

TIPS

- Store the removed screws.
After removing the player mount, put back the removed screws.

SHARP
SHARP CORPORATION