



**1200 WATTS/1600 WATTS/1800 WATTS/2100 WATTS-HEAVY DUTY
COMMERCIAL MICROWAVE OVEN**

MODELS R-22GV/R-22GT/R-23GT/R-24GT/R-25JT

OPERATION MANUAL

FOR CUSTOMER ASSISTANCE

To aid in reporting this commercial microwave oven in case of loss or theft, please record below the model number and serial number located on the unit. We also suggest you record all the information listed and retain for future reference.

MODEL NUMBER _____	SERIAL NUMBER _____
DATE OF PURCHASE _____	
Dealer _____	Telephone _____
Servicer _____	Telephone _____

TO PHONE:

SERVICE and PARTS
(for your nearest Sharp Authorized Servicer and Parts Distributor)
United States 1-800-BE-SHARP(237-4277)

ADDITIONAL
CUSTOMER INFORMATION 201-529-8706

TO WRITE:

For additional information:

Commercial Microwave Oven Department
Sharp Electronics Corporation
Sharp Plaza, Box 650
Mahwah, NJ 07430-2135

For service problems, warranty information, missing items and other assistance:

Sharp Electronics Corporation
Customer Assistance Center
1300 Naperville Drive
Romeoville, IL 60446-1091

Please provide the following information when you write or call: model number, serial number, date of purchase, your complete mailing address (including zip code), your daytime telephone number (including area code) and description of the problem.

CONTENTS

For Customer Assistance	Front cover		
Contents	1		
Precautions to Avoid Possible Exposure to Excessive Microwave Energy	1		
Limited Warranty	2		
Important Safety Instructions	3		
Service Call Check	4		
Grounding Instructions	5		
Installation	6		
Part Names	7		
Before Operation	8		
Memory Operation	8		
Cooking with memory	8		
Cooking double quantity with memory	8		
Memory program entry	9		
Memory check	10		
Manual Operations	11		
		Time cooking	11
		Multiple sequence cooking	11
		Express Defrost	12
		Express Defrost Chart	12
		Counter check	13
		Other Convenient Features	14
		Signal setting	14
		Demonstration mode	14
		Care and Cleaning	14
		Cooking Guide	16
		Utensils	16
		Guidelines for microwave heating	17
		Timing guide	18
		Heating and cooking time guide	19
		Reminders	21
		Specifications	21
		Auto-Touch Guide	22•Back cover

PRECAUTIONS TO AVOID POSSIBLE EXPOSURE TO EXCESSIVE MICROWAVE ENERGY

- (a) Do not attempt to operate this oven with the door open since open-door operation can result in harmful exposure to microwave energy. It is important not to defeat or tamper with the safety interlocks.
- (b) Do not place any object between the oven front face and the door or allow soil or cleaner residue to accumulate on sealing surfaces.
- (c) Do not operate the oven if it is damaged. It is particularly important that the oven door close properly and that there is no damage to the: (1) door (bent), (2) hinges and latches (broken or loosened), (3) door seals and sealing surfaces.
- (d) The oven should not be adjusted or repaired by anyone except properly qualified service personnel.

LIMITED WARRANTY

SHARP ELECTRONICS CORPORATION warrants to the first end-user purchaser that this Sharp brand product (the "Product"), when shipped in its original container, will be free from defective workmanship and materials, and agrees that it will, at its option, either repair the defect or replace the defective Product or part there of with a new or remanufactured equivalent at no charge to the purchaser for parts or labor for the period(s) set forth below.

This warranty does not apply to any appearance items of the Product nor to the additional excluded item(s) set forth below nor to any Product the exterior of which has been damaged or defaced, which has been subjected to improper voltage or other misuse, abnormal service or handling, or which has been altered or modified in design or construction.

In order to enforce the rights under this limited warranty, the purchaser should follow the steps set forth below and provide proof of purchase to the servicer.

To the extent permitted by applicable state law, the warranties set forth herein are in lieu of, and exclusive of, all other warranties, express or implied. Specifically, ALL OTHER WARRANTIES OTHER THAN THOSE SET FORTH ABOVE ARE EXCLUDED. ALL EXPRESS AND IMPLIED WARRANTIES INCLUDING THE WARRANTIES OF MERCHANTABILITY, FITNESS FOR USE, AND FITNESS FOR A PARTICULAR PURPOSE ARE SPECIFICALLY EXCLUDED. If, under applicable state law, implied warranties may not validly be disclaimed or excluded, the duration of such implied warranties is limited to the period(s) from the date of purchase set forth below.

Neither the sales personnel of the seller nor any other person is authorized to make any warranties other than those described herein, or to extend the duration of any warranties beyond the time period described herein on behalf of Sharp.

The warranties described above shall be the sole and exclusive warranties granted by Sharp and shall be the sole and exclusive remedy available to the purchaser. Correction of defects, in the manner and for the period of time described herein, shall constitute complete fulfillment of all liabilities and responsibilities of Sharp to the purchaser with respect to the Product, and shall constitute full satisfaction of all claims, whether based on contract, negligence, strict liability or otherwise. In no event shall Sharp be liable, or in any way responsible, for any damages or defects in the Product which were caused by repairs or attempted repairs performed by anyone other than an authorized servicer. Nor shall Sharp be liable or in any way responsible for any incidental or consequential economic or property damage. Some states do not allow limits on warranties or on remedies for breach in certain transactions; in such states, the limits herein may not apply.

Your Product Model Number & Description: R-22GV/R-22GT/R-23GT/R-24GT or R-25JT
Commercial Microwave Oven
(Be sure to have this information available when you need service for your oven.)

Warranty Period for this Product: Three (3) years for parts and labor in the end user's place of business.

Additional Item(s) Excluded from Warranty Coverage (if any): Non-functional accessories and light bulb.

Where to Obtain Service: Contract your Sharp Authorized Servicer to obtain on-site service for this Product. The Servicer will come to your location and if it is necessary to remove the Product, the Servicer will reinstall it. Be sure to have Proof of Purchase available.

TO OBTAIN SUPPLY, ACCESSORY OR PRODUCT INFORMATION, CALL 1-800-BE-SHARP.
Save the proof of purchase as it is needed should your oven require warranty service.

IMPORTANT SAFETY INSTRUCTIONS

When using electrical appliances basic safety precautions should be followed, including the following:

WARNING - To reduce the risk of burns, electric shock, fire, injury to persons or exposure to excessive microwave energy:

1. Read all instructions before using the appliance.
2. Read and follow the specific “**PRECAUTIONS TO AVOID POSSIBLE EXPOSURE TO EXCESSIVE MICROWAVE ENERGY**” on page 1.
3. This appliance must be grounded. Connect only to properly grounded outlet.
See “**GROUNDING INSTRUCTIONS**” on page 5.
4. Install or locate this appliance only in accordance with the provided installation instructions.
5. Some products such as whole eggs and sealed containers – for example, closed glass jars – are able to explode and should not be heated in this oven.
6. Use this appliance only for its intended use as described in this manual. Do not use corrosive chemicals or vapors in this appliance. This type of oven is specifically designed to heat, cook or dry food. It is not designed for industrial or laboratory use.
7. As with any appliance, close supervision is necessary when used by children.
8. Do not operate this appliance if it has a damaged cord or plug, if it is not working properly or if it has been damaged or dropped.
9. This appliance should be serviced only by qualified service personnel. Contact nearest Sharp Authorized Servicer for examination, repair or adjustment.
10. Do not cover or block any openings on the appliance.
11. Do not store or use this appliance outdoors. Do not use this product near water – for example, near a kitchen sink, in a wet basement, near a swimming pool or similar locations.
12. Do not immerse cord or plug in water.
13. Keep cord away from heated surfaces.
14. Do not let cord hang over edge of table or counter.
15. See door surface cleaning instructions on pages 14-15.
16. To reduce the risk of fire in the oven cavity:
 - a. Do not overcook food. Carefully attend appliance when paper, plastic or other combustible materials are placed inside the oven to facilitate cooking.
 - b. Remove wire twist-ties from paper or plastic bags before placing bag in oven.
 - c. If materials inside the oven ignite, keep oven door closed, turn oven off and disconnect the power cord or shut off power at the fuse or circuit breaker panel.
 - d. Do not use the cavity for storage purposes. Do not leave paper products, cooking utensils or food in the cavity when not in use.
17. Liquids, such as water, coffee, or tea are able to be overheated beyond the boiling point without appearing to be boiling. Visible bubbling or boiling when the container is removed from the microwave oven is not always present. **THIS COULD RESULT IN VERY HOT LIQUIDS SUDDENLY BOILING OVER WHEN A SPOON OR OTHER UTENSIL IS INSERTED INTO THE LIQUID.**
To reduce the risk of injury to persons:
 - a. Do not overheat the liquid.
 - b. Stir the liquid both before and halfway through heating it.
 - c. Do not use straight-sided containers with narrow necks. Use a wide-mouthed container.
 - d. After heating, allow the container to stand in the microwave oven at least for 20 seconds before removing the container.
 - e. Use extreme care when inserting a spoon or other utensil into the container.

SAVE THESE INSTRUCTIONS

SERVICE CALL CHECK

Please check the following before calling for service!

1. Plug the power cord into a three-pronged electric-outlet. (See page 5)
2. Place one cup of water in a glass measure in the oven and close the door securely.
 - A. Does the oven light come on? Yes _____ No _____
 - B. Does the cooling fan work? Yes _____ No _____
(Put your hand over the back ventilating opening.)
 - C. If "No", please check wall outlet and circuit breaker.
3. Touch these pads:

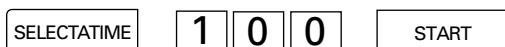

- A. Does the "ON" indicator come on? Yes _____ No _____
- B. At the end of 1 minute, is the water hot? Yes _____ No _____

IF SERVICE IS NEEDED, PLEASE CONTACT YOUR NEAREST AUTHORIZED SHARP SERVICER.

ERROR MODE

Should any of the error indicators appear in the readout, follow the instructions:

EE Mode	Reason	Action Required
EE 1, EE 2	Magnetron failure	Call for service.★
EE 3	Both magnetrons failed	Call for service.
EE 4 R-23GT, R-24GT and R-25JT only	Voltage too high	Follow instructions on page 5 of Operation Manual under VOLTAGE SELECT to change from 208V to 230V. If problem is not corrected, call an electrician.
EE 5 R-23GT, R-24GT and R-25JT only	Voltage too low	Follow instructions on page 5 of Operation Manual under VOLTAGE SELECT to change from 230V to 208V. If problem is not corrected, call an electrician.
EE 6, EE10, EE16	Thermistors failure	Call for service.
EE 7	Exhaust air temperature too high	Check that nothing is blocking air intake openings on oven back or that oven exterior is very hot. Correct. Wait a few minutes and try again. If problem persists, call for service.
EE 8	Circuit failure	Call for service.
EE 9	Maximum time is exceeded	Check page 11 in the Operation Manual. Touch STOP/CLEAR pad, and reprogram correctly.
EE 0	Fan lock error	Call for service.
EE17	Magnetron temperature too high	Touch STOP/CLEAR pad. Wait a few minutes and try again. If problem persists, call for service.

★ EE 1 and EE 2: Can continue to use oven before service; however, check food carefully as additional cooking time will be needed.

Any time the EE is flashing, the servicer should be called. When EE is not flashing, check the reason and correct. Service is not necessary.

GROUNDING INSTRUCTIONS

GROUNDING INSTRUCTIONS

This appliance must be grounded. In the event of an electrical short circuit, grounding reduces the risk of electric shock by providing an escape wire for the electric current. This appliance is equipped with a cord having a grounding wire with a grounding plug. The plug must be plugged into an outlet that is properly installed and grounded.

WARNING – Improper use of the grounding plug can result in a risk of electric shock. The electrical requirements are 120 Volt, 60 Hz AC only, 20 Amp or more (R-22GV, R-22GT); 230/208 Volt, 60 Hz, AC only, 15 Amp or more (R-23GT) and 20 Amp or more (R-24GT, R-25JT) fused electrical supply. It is recommended that a separate circuit serving only this appliance be provided. When installing this appliance, observe all applicable codes and ordinances. If it is necessary to use an extension cord, use only a 3-wire extension cord that has a 3-blade grounding plug and a 3-slot receptacle that will accept the plug on the appliance. The marked rating of the extension cord should be AC 120 Volt 20 Amp (R-22GV, R-22GT), AC 230/208 Volt 15 Amp (R-23GT), AC 230/208 Volt 20 Amp (R-24GT, R-25JT). Consult a qualified electrician or serviceman if the grounding instructions are not completely understood or if doubt exists as to whether the appliance is properly grounded.

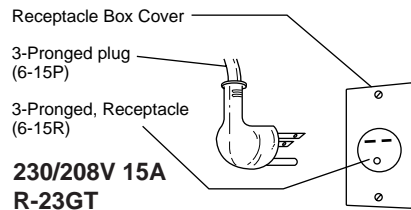
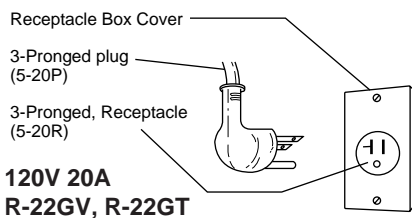

Radio or TV Interference

Should there be any interference caused by the microwave oven to your radio or TV, check that the microwave oven is on a different electrical circuit, relocate the radio or TV as far away from the oven as feasible or check position and signal of receiving antenna.

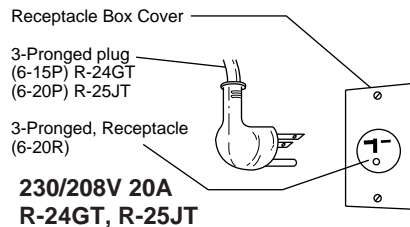

VOLTAGE SELECT

The R-23GT, the R-24GT and the R-25JT have been preset for 208V operation.

If you need to change this oven for 230V operation, follow instructions below.

1. Unplug oven.
2. Remove one screw(A) from the Voltage Select Cover located on back of the oven near the bottom.
3. Remove the Voltage Select Cover and rotate 180 degrees.
4. Reinstall the Voltage Select Cover using one screw(A) removed in Step 2.
5. Plug power cord into wall outlet.

Your oven is now ready for 230V, 60Hz operation.

Note: If "EE4" or "EE5" appears in the lighted digital display, a voltage adjustment must be made.

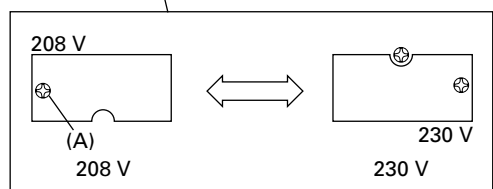
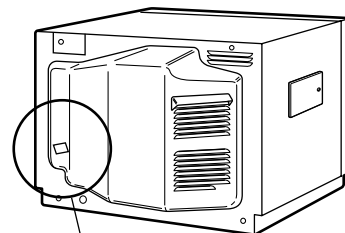

INSTALLATION

INSTALLATION

Because your Sharp Commercial Microwave Oven will be used frequently, place it so that there is easy access for all users.

1. Be sure all electrical requirements are met. See page 5.
2. Exhaust vents are on the back of the unit near the top. Install the unit at least 2 inches away from the nearest wall to permit adequate ventilation for proper cooling and air flow in the oven.
3. Install the unit where no excessive heat or steam are generated. Do not place next to an oven or cooking surface.
4. The unit may be secured to a countertop or stand. There is a screw hole in the bottom of the unit. After the oven is permanently placed, drill a hole through the counter top for a 3/16 inch self-tapping screw. The hole should be 12 inches from the hinge side of the oven door and 5 1/4 inches back from the front edge of the removable filter.
5. **STACKING PROCEDURE FOR TWO MICROWAVE OVENS**
Two units can be installed together by placing one on top of the other. Follow these instructions:
 - a. Place oven A in the desired location. Position Oven B on top of Oven A as shown in the figure.
 - b. Remove Screws (b) from the lower edge of the back of Oven B.
 - c. Loosen Screw (a) which holds Mounting Plate A on the back of Oven A.
 - d. Turn Mounting Plate A 180° so that it is on the lower edge of Oven B.
 - e. Using Screw (b) removed in step b, install Mounting Plate A to the lower edge of Oven B as shown in the figure.
 - f. Tighten Screw (a) which was loosened in step c.
 - g. Remove another Screw (a) which holds Mounting Plate B on the back of Oven B. Remove Mounting Plate B.
 - h. Replace Screw (a) removed in step g and tighten.
 - i. Remove Screw (c) from the rear of Oven A.
 - j. Remove Screw (d) from the rear of Oven B.
 - k. Turn Mounting Plate B and position it on Ovens A and B as shown in the figure. Using Screws (c) and (d), fasten Mounting Plate B in place.

WARNING:

When two ovens are installed together by placing one on top of another:

1. Always use two mounting plates.
2. Make sure that the power supply cords are not caught between the ovens.
3. Do not install more than one oven on top of another.

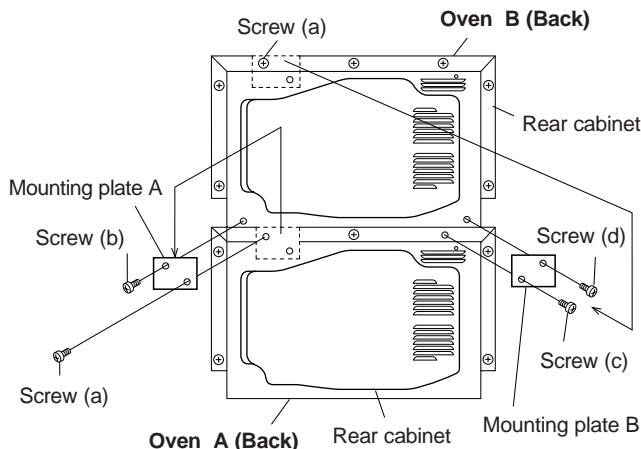

Figure

PART NAMES

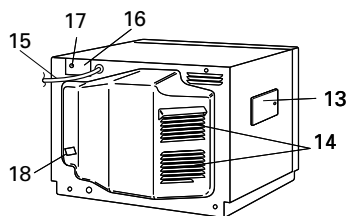
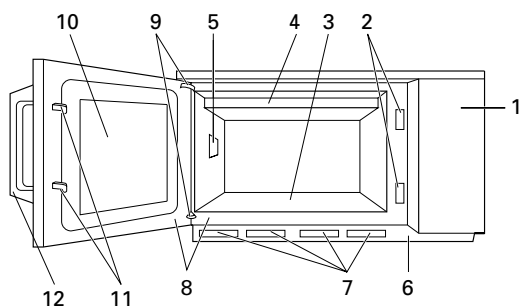

- | | |
|--|--|
| <ul style="list-style-type: none"> 1. Touch control panel 2. Door latch openings 3. Ceramic shelf 4. Splash cover 5. Oven light 6. Air intake filter 7. Air intake openings 8. Door seals and sealing surfaces 9. Door hinges | <ul style="list-style-type: none"> 10. Oven door with see-through window 11. Door latches 12. Door handle 13. Service window for replacing the oven light bulb 14. Ventilation openings 15. Power supply cord 16. Mounting plate 17. Screw for mounting plate 18. Voltage select cover
(R-23GT/R-24GT/R-25JT) |
|--|--|

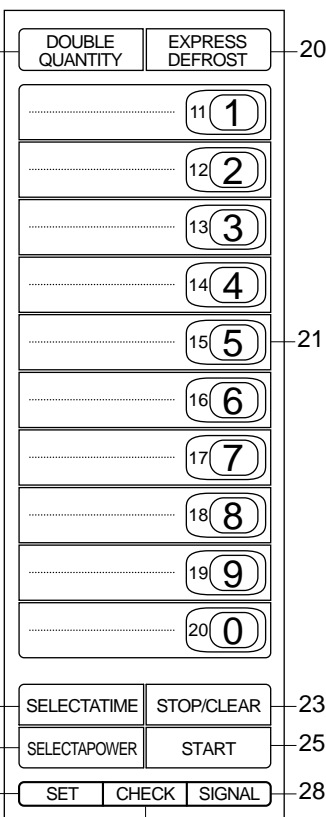
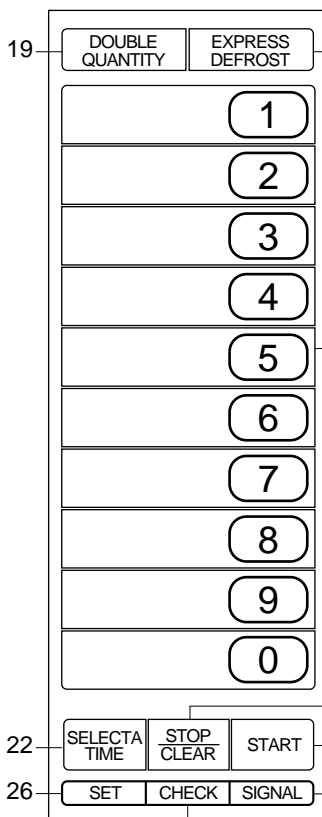
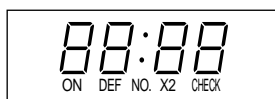
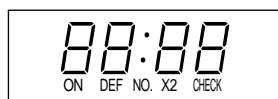

- 19. DOUBLE QUANTITY pad
- 20. EXPRESS DEFROST pad
- 21. Ten number pads for time and memory programming
- 22. SELECTATIME pad
- 23. STOP/CLEAR pad; touch to stop operation of oven and clear remaining heating time
- 24. SELECTAPOWVER pad for setting variable power level
- 25. START pad; touch to operate oven after door is closed and time is set
- 26. SET pad for setting memory
- 27. CHECK pad for checking memory
- 28. SIGNAL pad for setting signal sound

Accessory: Menu labels

R-22GV

R-22GT, R-23GT, R-24GT, R-25JT

BEFORE OPERATION

- * Before operating your new oven, make sure you read and understand this operation manual completely.
- 1) Plug in the oven.
 - * The digital display will then show . .
- 2) You can input the pads only when the door is closed.
- 3) Oven light and fan motor work for 1 minute whenever the door is opened or after cooking.

- 4) The program and the check are canceled when any pads are not touched for more than 3 minutes.
- 5) During cooking, except memory cooking, the oven stops when the door is opened, and the program is canceled if the START pad is not touched within 1 minute after the door is closed.
- 6) The cooking is canceled when the door is opened during memory cooking.

MEMORY OPERATION

The R-22GT, R-23GT, R-24GT and R-25JT models have 20 and R-22GV model has 10 memory banks which can store cooking programs. The first ten memory banks have been programmed previously as follows, but they can be changed. See page 9.

Memory No.	Cook Time	Output Power
1	10 sec.	100%
2	20 sec.	100%
3	30 sec.	100%
4	45 sec.	100%
5	1 min.	100%
6	1 min. 15 sec.	100%
7	1 min. 30 sec.	100%
8	2 min.	100%
9	2 min. 30 sec.	100%
0	3 min.	100%

Information in these memory banks is not lost due to power interruptions. If the power goes off, the oven does not need to be reprogrammed. No batteries are necessary for this type of memory.

Cooking with memory

- * Suppose you want to cook by using memory 1, which was programmed for 10 seconds at 100%.

Procedure	Display
1	NO. 1
1 Place food in oven. Touch number pad.	
	After about 1 sec.
	ON . 10

Cooking double quantity with memory

Double quantity means the best time for cooking two servings or twice the amount programmed in the memory pad; it is not double the time.

- * Suppose you want to cook 2 servings by memory number 1.

Procedure	Display
DOUBLE QUANTITY	
1 Place food in oven. Touch DOUBLE QUANTITY pad.	NO. X2
1	NO. X2 1
2 Touch number pad.	
	After about 1 sec.
	ON . 18

Note: The "MEMORY" cooking system does not require the use of the START pad. Memory pad cannot be used to start the oven if any program is on display.

If the door is opened during memory cooking, the program is canceled. To stop the cooking of a memory pad and then restart, first, touch the STOP/CLEAR pad, then open the door, check food, close door and touch START.

If your programmed time is over maximum time at Double Quantity, you cannot use Double Quantity for the memory. You can cook only 1 serving. See page 11.

Note: (For R-22GT/23GT/24GT/25JT)
If you want to cook by using memory 11-20, touch the desired number pad twice within 1 second.

Memory program entry

You can change memory programs for memory banks. See time cooking on page 11.

R-22GT/23GT/24GT/25JT

Memory banks 20

Cooking stage

Memory NO.1 -10 max. 3 stages

Memory NO. 11-20 max. 2 stages

R-22GV

Memory banks 10

Cooking stage 1 stage

The R-22GV oven can be programmed only using 100% power. Follow steps 1,2,3 and 7 below.

Setting time and power level

* Suppose you want to set 4 minutes at 60% for the 1st stage and 2 minutes at 30% for the 2nd stage for 1 serving in memory 1.(R-22GT/23GT/24GT/25JT)

Procedure	Display
1 Touch SET pad twice within 2 sec.	NO.
2 Touch number pad.	NO. 1
3 Enter cooking time for 1st stage.	4.00
4 Enter power level in 1st stage.	P- 60
5 Enter cooking time for 2nd stage.	2.00
6 Enter power level for 2nd stage.	P- 30
7 Touch SET pad twice.	.

Note: 1. (For R-22GT/23GT/24GT/25JT)

Touch SELECTAPOWVER twice for High power when programming stages. If High is the power level of the last stage, it is not necessary to touch SELECTAPOWVER at all.

- If you want to set memory 11-20, press the desired number pad twice.
- If the cooking time is over the maximum time, the display will show "EE 9". See page 11.
- At step 1, no audible signal will be heard when the SET key is touched the first time. An audible signal will sound when the SET key is touched the second time.

Setting magnification factor

Ovens are shipped with a magnification factor of 1.8 for DOUBLE QUANTITY.

You can change the magnification factor for double quantity and have it stored in the memory.

* Suppose you want to set the magnification factor to 1.67 for double quantity in memory 1.

Procedure	Display
1 Touch SET pad twice within 2 sec.	NO.
2 Touch DOUBLE QUANTITY pad.	NO. X2
3 Touch number pad 1.	NO. X2 1
4 Touch SELECTATIME pad.	0.00 X2
5 Touch NUMBER pads 1,6 and 7.	1.67 X2
6 Touch SET pad twice.	.

- Note: 1. In case you want to change the magnification factor it must be set for each pad separately.
- The magnification factor can be set from 0.00 to 9.99.
 - At step 1, no audible signal will be heard when the SET pad is touched the first time. An audible signal will sound when the SET pad is touched the second time.

Memory check

You can check the information programmed into the memory.

Checking time and power level

* Suppose you want to know the information programmed into the memory 1, programmed for 4 minutes at 60% for the 1st stage and 2 minutes at 30% at the 2nd stage.

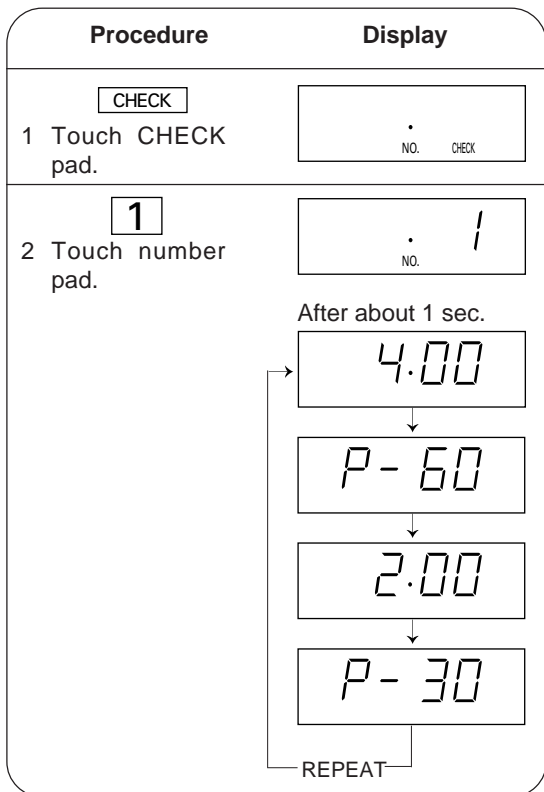

- Note: 1. To cancel memory check, touch the CHECK pad.
 2. When . 0 is displayed at Step 1, the memory is not set.
 3. (For R-22 GT/23GT/24GT/25JT)
 If you want to check memory 11-20, touch the desired number pad twice.

Checking magnification

* Suppose you want to know the magnification factor for double quantity in memory 1.

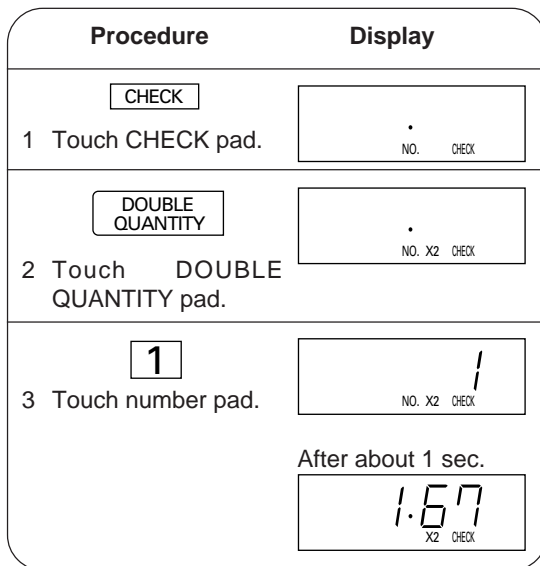

- Note: 1. To cancel memory check, touch the CHECK pad.
 2. The magnification factor 1.80 for the DOUBLE QUANTITY is stored in all memories when the oven is shipped.

MANUAL OPERATIONS

Time cooking

R-22GT/23GT/24GT/25JT

Your oven can be programmed for up to 3 cooking sequences and has 11 preset microwave power levels.

Total cooking time Maximum of 30 minutes

Touch SELECTAPOW ER PAD ONCE THEN TOUCH	APPROXIMATE PERCENTAGE OF POWER	Display
SELECTAPOW ER	100%	P-41★
9	90%	P-90
8	80%	P-80
7	70%	P-70
6	60%	P-60
5	50%	P-50
4	40%	P-40
3	30%	P-30
2	20%	P-20
1	10%	P-10
0	0%	P-0

* Not necessary to touch SELECTAPOW ER if only one stage or if the last stage.

R-22GV

Your oven can be programmed for only one stage on 100% power level with a maximum of 30 minutes. Follow steps 1 and 3.

Cooking sequence 1 stage

Microwave power level 100% only

Cooking time Max. 30 minutes

* Suppose you want to cook for 2 minutes and 30 seconds at 50%.

Procedure	Display
SELECTATIME 2 3 0 1 Enter cooking time.	2.30

SELECTAPOW ER 5 2 Enter power level. (R-22GT/23GT/ 24GT/25JT only)	P-50
START 3 Touch START pad.	ON 2.30

Note: It is not necessary to touch SELECTAPOW ER pad for 100%. If the cooking time is over the maximum time, the display will show "EE 9".

Multiple sequence cooking

(R-22GT/23GT/24GT/25JT only)

* Suppose you want to cook for 4 minutes at 60% for 1st stage and then continue to cook for 2 minutes at 30% for 2nd stage.

Procedure	Display
SELECTATIME 4 0 0 1 Enter cooking time for 1st stage.	4.00
SELECTAPOW ER 6 2. Enter power level for 1st stage.	P-60
SELECTATIME 2 0 0 3. Enter cooking time for 2nd stage.	2.00
SELECTAPOW ER 3 4. Enter power level for 2nd stage.	P-30
5. Touch START pad.	ON 6.00

Express Defrost

Use EXPRESS DEFROST to defrost meat and poultry faster and better. Calculate total defrost time from chart below. Express Defrost can be programmed for a maximum of 90 minutes.

* Suppose you want to defrost one pound of lamb chops for 3 minutes and 30 seconds.

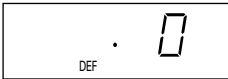
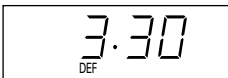
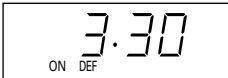
Procedure	Display
<div style="border: 1px solid black; padding: 2px; display: inline-block; margin-bottom: 5px;">EXPRESS DEFROST</div> 1 Touch EXPRESS DEFROST pad.	
<div style="display: inline-block; border: 1px solid black; padding: 2px; margin-right: 5px;">3</div> <div style="display: inline-block; border: 1px solid black; padding: 2px; margin-right: 5px;">3</div> <div style="display: inline-block; border: 1px solid black; padding: 2px;">0</div> 2 Enter defrosting time. (Refer to chart below.)	
<div style="border: 1px solid black; padding: 2px; display: inline-block; margin-bottom: 5px;">START</div> 3 Touch START pad.	
Midway through the defrosting cycle, CHECK will light in the display and an audible signal will be heard. You may open the door, turn food over and shield any warm portions. Close the door.	
<div style="border: 1px solid black; padding: 2px; display: inline-block; margin-bottom: 5px;">START</div> 4 Touch START pad.	

TIPS: Allow foods to stand a few minutes after defrosting to equalize the temperature for better cooking results.

Check food after standing. If additional time is needed, continue to defrost with time cooking. It is better to defrost with 30% power for R-22GT/23GT/24GT/25JT. For R-22GV, it is better to defrost with Express Defrost continuously.

Foods that are the same thickness throughout defrost better. If foods have varied thickness, it may be necessary to shield the thin edges with small flat pieces of aluminum foil to prevent overdefrosting.

Express Defrost Chart

Food	Thickness	Time (min./lb.)			
		R-22GT R-22GV	R-23GT	R-24GT	R-25JT
Beef steak	less than 1"	4-4 ¹ / ₂	2-2 ¹ / ₂	2-2 ¹ / ₂	1 ³ / ₄ -2 ¹ / ₄
	more than 1"	5-5 ¹ / ₂	2 ¹ / ₂ -3 ¹ / ₂	2 ¹ / ₂ -3 ¹ / ₂	2-3
Lamb chops	1"	4-5	2 ¹ / ₂ -4	2-3 ¹ / ₂	1 ³ / ₄ -2 ³ / ₄
Pork chops	less than 1"	3 ¹ / ₂ -4	2 ¹ / ₂ -3	2-2 ¹ / ₂	1 ³ / ₄ -2 ¹ / ₄
	more than 1"	5-5 ¹ / ₂	3-4	2 ¹ / ₂ -3 ¹ / ₂	2-3
Boneless chicken breasts	1/2"-3/4"	4-5	2 ¹ / ₂ -3 ¹ / ₂	2-3	1 ¹ / ₂ -2 ¹ / ₂
	3/4"-1"	4 ¹ / ₂ -5 ¹ / ₂	3-4	2 ¹ / ₂ -3 ¹ / ₂	2-3
Fish steak	1/2"-3/4"	2-3	1 ¹ / ₂ -2 ¹ / ₂	1 ¹ / ₄ -2	1-1 ³ / ₄
	3/4"-1"	3-4	2-3	1 ³ / ₄ -2 ¹ / ₂	1 ¹ / ₄ -2

Counter check

Set counter to "0" before using oven for the first time. See next column.

Counter check

You can check total number of using times, times of using each memory, times of using manual cooking and times of using EXPRESS DEFROST.

Total count Touch CHECK pad twice.

To check for each counter, touch each pad as indicated below, after touching CHECK pad twice.

Count of memory Touch each number pad of memory.

Count of manual cooking Touch SELECTATIME pad.

Count of EXPRESS DEFROST Touch EXPRESS DEFROST pad.

* Suppose you want to know total using times and times of using each memory. In that case the oven was used 8268 times and the memory 1 was used 513 times.

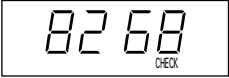
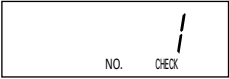
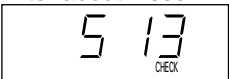

Procedure	Display
<p><input type="button" value="CHECK"/> x 2</p> <p>1 Touch CHECK pad 2 times. Total count will be displayed.</p>	
<p><input type="button" value="1"/></p> <p>2 Touch number pad 1, for checking times of using memory 1.</p>	 <p>After about 1 sec.</p> 

Note: 1. To cancel counter check, touch CHECK pad.
 2. (FOR R-22GT/23GT/24GT/25JT)
 You can know count of memory No.1 - 10 only. Memory No.11 - 20 cannot be checked.
 3. Each counter can count the times to 9999, and then it will return to 0.

To clear the number of times

Each number of times can be cleared by touching SET pad during checking mode.

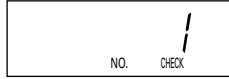
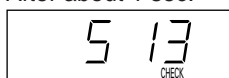
* Suppose you want to clear the times of memory1.

Procedure	Display
<p><input type="button" value="CHECK"/> x 2</p> <p>1 Touch CHECK pad 2 times. Total count will be displayed.</p>	
<p><input type="button" value="1"/></p> <p>2 Touch number pad 1 for checking times of using memory 1.*</p>	 <p>After about 1 sec.</p> 
<p><input type="button" value="SET"/></p> <p>3 Touch SET pad.</p>	

Note: 1. To cancel counter check, touch CHECK pad.
 2. To clear times of manual cooking, touch SELECTATIME pad in Step 2 instead of number pad.
 3. To clear times of Express Defrost use, touch EXPRESS DEFROST pad in Step 2 instead of number pad.
 4. To clear total using times, skip Step 2.

OTHER CONVENIENT FEATURES

Signal setting

There is a choice of 2 different sounds and no sound on your oven.

To set signal, touch the SET pad twice within 2 sec., and then touch the SIGNAL pad continuously until you hear desired tone.

Demonstration Mode

To demonstrate, touch SELECTATIME, 0 and then touch START and hold for 3 seconds. Cooking operations can now be demonstrated with no power in the oven. The timer will count down rapidly.

To cancel, touch SELECTATIME, then 0 and STOP/CLEAR.

CARE AND CLEANING

VERY IMPORTANT CAUTIONS

- *DO NOT OPERATE the oven without the splash cover in place.
- *DO NOT REMOVE the splash cover UNLESS THE POWER CORD IS REMOVED FROM THE OUTLET because the stirrer fan, which is located on the ceiling, operates for 1 minute after the door is opened and injury could occur.
- *DO NOT REMOVE the ceramic shelf from the oven.
- *DO NOT OPERATE the oven without the air intake filter in place.
- *DO NOT USE commercial oven cleaners, abrasive or harsh cleaners or scouring pads on any part of your microwave oven.

Oven Exterior

The outside of your oven can be easily cleaned with mild soap and water. Make sure to rinse thoroughly and dry the exterior with a soft towel.

Control Panel

Care should be taken in cleaning the control panel. Open the door before cleaning to inactivate the control panel pads.

Using a cloth dampened with water only, gently wipe the panel until it becomes clean. Avoid the use of excess water. Do not use any sort of chemical or abrasive cleaner because to do so may cause severe damage to the panel and make programming impossible.

CARE AND CLEANING

Oven interior

- 1) For easy cleaning, wipe any spatters or spills with a soft damp cloth or sponge at the end of each day. For heavier spills, use mild soap and rinse thoroughly with hot water.
- 2) At least once a week, remove the splash cover and wash in a mild detergent solution. The splash cover is located in the top of the oven and may easily be be removed. **REMEMBER TO UNPLUG THE POWER CORD.** Remove two thumb screws (A) as shown in Fig. 1. Then remove the splash cover from the oven.
To replace the splash cover, insert two projections of the cover (B) into the holes of the oven cavity backplate as shown in Fig. 2. And secure the cover to the oven ceiling with two thumb screws (A) as shown in Fig.1.
- 3) Wipe any grease, spills or spatters on the door seal surfaces with a soft damp cloth or sponge so that they do not build up. The door seals must always be free of grease and spatters so that the door closes properly.

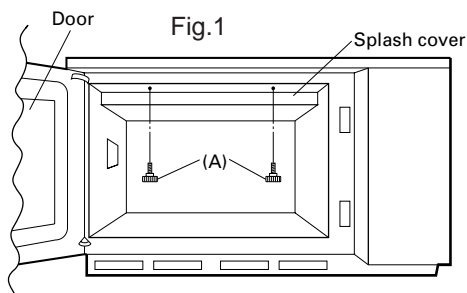

Door

Wipe the door and window on both sides frequently with a damp cloth to remove any spills or spatters. Always keep the door seals and seal surfaces clean so that any grease, spills or spatters are not allowed to build up. Such a build-up could result in leakage of microwave energy from the oven.

Air intake filter

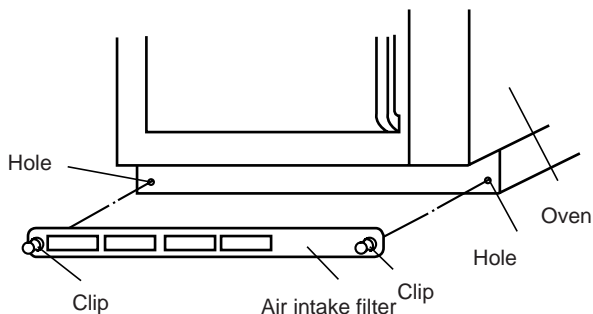

Keep the air intake filter clean. Clean at least every two weeks or more often for heavy use. Remove the air intake filter by pulling the two (2) clips on the sides of the filter. Wash the air intake filter in mild soapy water, rinse and dry with a soft cloth. After cleaning re-install the air intake filter.

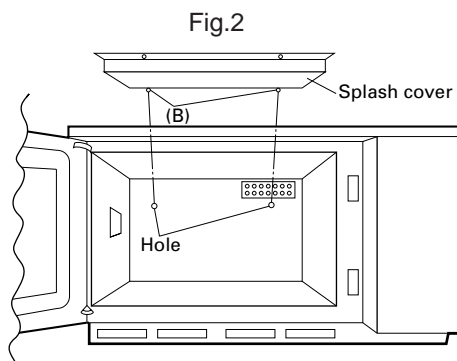

COOKING GUIDE

Utensils

METAL

1) Frozen Precooked Foods in Foil Containers

When cooking foods in foil containers, the container should be no more than 1/2" deep. The best method to use is, after removing the foil cover, return the metal container to the paper box or package it came in and place this entire unit in the microwave oven. There must be more food than metal, and the metal container must not touch the oven walls.

2) Metal Skewers

Small metal skewers may be used if there is a large proportion of food to the amount of metal. If arcing does begin, stop the oven, remove the food and change to a wooden skewer.

Whenever using metal foil, foil containers or metal skewers, be sure that the metal does not touch the sides of the oven.

GLASS, GLASS-CERAMIC, CERAMIC AND CHINA UTENSILS

Most glass, glass ceramic, ceramic and china utensils are excellent for use in microwave ovens. Heat-resistant glassware, unless it has metallic trim or metal portions, can almost always be used in the microwave oven, no matter whether it is clear or opaque. However, you must be careful not to use delicate glassware since it might crack from the heat of the food but not from the microwaves.

Most dinner plates, unless they have metallic trim, are acceptable for heating foods.

Utensils with metallic trim or metal parts, such as screws, bands, handles, etc. must be avoided. Cracked or crazed glazes or chips are also indications that a dish should not be used. Ceramic mugs or cups with glued on handles are also not recommended for use in a microwave oven.

PAPER GOODS

For low heat cooking, such as reheating or very short cooking times and for foods with low fat, sugar or water content, paper is a good utensil for microwave oven use. Napkins, towels, plates, cups, cartons, paper freezer wrap and the paper pulp board that some meats come packed in are also convenient utensils for use in the microwave oven. Cardboard can also be used. Paper is used in the microwave oven as a moisture insulator. Wax coated paper plates and cups should be avoided since the high temperatures that the foods reach may cause the wax to melt. Plastic coated dishes, however, are fine for use in the microwave oven.

Wax paper and paper towels provide an excellent loose cover for foods and help prevent spatters. Do not use paper towels, plates or other utensils made from recycled paper. Recycled paper products may contain certain impurities which could cause the paper to ignite during microwave heating. Some paper products may contain harmful substances.

PLASTIC AND FOAM UTENSILS

Plastic and foam dishes and containers should not be used for cooking foods with high fat or high sugar content since the heat of the food is too hot for the plastic and may cause it to melt or lose its shape. Cooking pouches designed to withstand boiling and freezing for conventional cooking, work well in the microwave oven. Do not close plastic cooking pouches with the metal tie wraps provided, since they get very hot and will melt the plastic wrap. Any closed pouch or cooking container should be pierced so that steam is allowed to escape. Do not attempt to cook in plastic storage bags as they will not withstand the heat of the food. Plastic wrap may be used to cover foods during cooking. Stretch-type plastic wraps are not suitable for use in the microwave oven because they form too tight a seal. Whenever removing plastic wrap that has been tightly formed around the utensil, just lift the plastic away from you so that the steam can vent and there will be no danger of scalding.

Melamine is not recommended for use in the microwave oven.

WICKER, WOOD AND STRAW

Wicker, wood and straw may be used in the oven for short periods of time; however, they should not be used for high fat or high sugar content foods since the heat of the food could possibly char the utensil. Wooden handle scrapers and spatulas may be left in the microwave oven during cooking.

Guidelines for microwave heating

Several factors should be kept in mind when selecting utensils to be used for microwave heating.

1. A plate with a narrow rim of about 1/2-inch is recommended. This keeps the food all at the same level for more even, uniform heating.
2. Casseroles and sauced items should be heated in straight sided containers.
3. Containers should be chosen to be large enough to contain foods as they expand with heating. Milk products are especially subject to boil-overs.
4. Most foods heat better if they are covered. Covering retains the heat that has been created, reduces dehydration and helps keep the oven clean. There should be an opening for steam to escape from the food. Covers should also be non-metallic to allow for proper heating.

Techniques

1. Microwave cooking is ideal for times when you run out of certain items or for preparation during slow periods.
2. Avoid overcooking. Small portions of food should stand 2-3 minutes following cooking; during this standing time foods will complete cooking. Large portions require longer standing times.
3. When a range of times is given in a recipe (2-3 minutes), always cook the shorter amount of time and check for doneness. Foods can always be returned to the microwave for additional cooking. Overcooked foods are tough or dry.
4. Arrange foods with thicker portions or larger pieces toward the outside of the cooking container. Most foods cook more evenly and faster if covered.
5. The microwave oven is quite useful in reducing broiling times for steaks and chops. Partially prepare the meat in microwave oven, then broil for a shorter period of time.
6. Sliced meats should be at least 1/2-inch thick for best heating results. Turning the meat product over once during the heating process will yield more uniform heating.
7. Stir liquids briskly before heating and allow to stand at least for 20 seconds after heating before stirring or drinking to avoid eruption.

Pastries

1. Placing rolls or muffins on a paper towel or napkin or wrapping in a paper towel eliminates excess moisture and gives best results.
2. Avoid overheating. Baked items will be hotter on the inside than on the outside. Overheating causes baked products to be dry and tough.

Breakfast Items

1. Eggs should be slightly undercooked when preparing them for later reheating in the microwave. Cool quickly and store covered.
2. Arrange foods on platter with easily heated items near center of plate (eggs) and denser items toward outside (sausage).
3. Do not cook eggs in the shell. Pressure will build up inside the shell and it will burst. Do not reheat cooked eggs unless they are scrambled or chopped. Puncture the yolk before cooking eggs.

Sandwiches

1. Pre-toast bread and cool on air rack. Egg and shortening rich bread gives best results.
2. Sandwich meats should be sliced very thin. When assembling sandwich, place thicker portions toward outside edges.
3. Cover sandwiches and refrigerate no longer than three hours. When ready to heat in the microwave, unwrap and place on paper towel or napkin. Most sandwiches should be heated uncovered unless wrapped in paper towel or napkin. The paper absorbs excess moisture, preventing the sandwich from becoming soggy.
4. Avoid overheating. Filling heats rapidly, and overheated sandwiches become dry and tough.

Casseroles

1. Arrange casseroles with larger pieces or bulk of food around the perimeter of the casserole; depress in center.
2. Casseroles should be heated covered with a non-metallic cover or plastic wrap except casseroles with crusts. If tightly covered, puncture plastic wrap or loosen at one corner so steam can escape. Be careful when removing plastic wrap; pull wrap away from you with the tines of a fork.
3. Cover casseroles evenly with sauce or gravy before refrigerating.

Vegetables

1. Arrange vegetables with larger pieces around the perimeter of the dish; depress in center.
2. Small uniform sized vegetables like peas, diced carrots and corn heat easily in the microwave oven. A butter sauce will speed the process.
3. Heat vegetables covered with either a non-metallic cover or plastic wrap. If tightly covered, puncture plastic wrap or loosen at one corner so steam can escape. Be careful when removing plastic wrap; pull wrap away from you with the tines of a fork.
4. Most vegetables should be slightly undercooked when preparing for later reheating in the microwave. Cool quickly and store covered.
5. Microwaved vegetables retain their bright color, flavor and nutrients.

Defrosting

1. See page 12 for EXPRESS DEFROST directions.
2. Avoid over-defrosting. Foods should be removed from the microwave when they are still slightly icy in the center. Allow foods to stand covered for 1 to 2 minutes to complete defrosting.
3. SELECTAPOWVER allows you to defrost food at the power level and speed you choose. Generally defrosting is done at 30% or lower. To use SELECTAPOWVER for defrosting, first program time followed by touching the SELECTAPOWVER pad and the number pad for percentage of power level (for example, 3 represents 30% power). The microwave power will pulse on and off to defrost frozen foods gently without heating. (Not on R-22GV)

Timing guide

Since different foods heat at different rates of speed, there are several influencing factors that should be taken into consideration when heating foods with microwave energy.

1. The lower the initial temperature of a food, the longer it will take to heat in a microwave oven.
2. Since with a microwave oven you are heating with time rather than temperature, it is helpful to know the starting temperatures of the foods. Foods held at room temperature will heat more quickly than refrigerated foods.
3. The different chemical makeups of foods affect the heating times. Highly salted foods heat faster than non-cured items. Animal fats heat more quickly than lean parts of meat. Fats in a colloidal state heat faster than protein (egg yolk cooks before the white).
4. The density of a food is determined by how compact the molecules are arranged within the food. A pound of roast beef is denser than a pound of bread. Even though they weigh the same, the bread contains more air and is therefore less dense. Denser foods require longer heating times.
5. The thicker the food, the longer the heating time. If two foods have the same density, the thinner food will heat before the thicker one.
6. The shape of the food also affects the heating time. Low round foods that are depressed in the center heat faster than highly mounded scooped foods. This has to do again with the density. The denser the mass to be heated, the longer the heating time.
7. The more food placed in the oven cavity at one time, the longer the heating time. This is because there is a constant level of energy coming out of the magnetron tube during the heating process. If there are several food items in the oven, they will each absorb some of the energy thus making the total heating time longer. The time required for heating is not directly proportional to the increased amount of food. The heating time should be increased by about 80% for each additional like food item.

Heating and cooking time guide

Quantity	Item	Approximate Heating Time 100% Power (seconds)				Comment:
		R-22GV R-22GT	R-23GT	R-24GT	R-25JT	
Pastries, Rolls and Baked Goods						
2	Biscuit	10	6-7	5-6	4-5	Heat, uncovered, from room temp.
1	Bun	6	4	3-4	3-4	Heat, uncovered, from room temp.
1	Danish Pastry	10	6-7	5-6	4-5	Heat, uncovered, from room temp.
1	Dinner, Roll	6	4	3-4	3-4	Heat, uncovered, from room temp.
1	Doughnut	6	4	3-4	3-4	Heat, uncovered, from room temp.
1	Muffin (small)	6	4-5	3-4	3-4	Heat, uncovered, from room temp.
1 slice	Pie	30	25	22	20-22	Heat, uncovered, from refrig.
1	Sweet Roll	10	6-7	5-6	4-5	Heat, uncovered, from room temp.
Breakfast Items						
8 oz.	French Toast & Bacon	60-70	40-50	35-45	25-35	Heat, uncovered, from refrig.
8 oz.	French Toast & Sausage	60-70	40-50	35-45	25-35	Heat, uncovered, from refrig.
6 oz.	Pancakes & Bacon	40-50	35-40	30-35	20-25	Heat, uncovered, from refrig.
6 oz.	Pancakes & Sausage	40-50	35-40	30-35	20-25	Heat, uncovered, from refrig.
5 oz.	Scrambled Eggs & Bacon	45-55	35-40	30-35	25-30	Heat, covered, from refrig.
5 oz.	Scrambled Eggs & Sausage	45-55	35-40	30-35	25-30	Heat, covered, from refrig.
4 strips	Bacon	40-50	35-40	30-35	25-30	Heat, covered, from refrig.
4 links	Sausage	40-50	35-40	30-35	25-30	Heat, covered, from refrig.
Sandwiches						
4-5 oz.	Bacon & Tomato	20-30	15	13-18	10-15	Heat, uncovered, from refrig.
4-5 oz.	Beef Barbecue	20-30	15-20	13-18	10-15	Heat, uncovered, from refrig.
4-5 oz.	Burger	30-35	21-26	18-23	15-20	Heat, uncovered, from refrig.
4-5 oz.	Cheeseburger	38-43	28-33	24-29	20-25	Heat, uncovered, from refrig.
4-5 oz.	Corned Beef	20-30	15-20	13-18	10-15	Heat, uncovered, from refrig.
2 oz.	Frankfurter	29-35	25-28	21-24	17-20	Heat, uncovered, from refrig.
5 oz.	Jumbo Frankfurter	40-45	36-39	31-35	27-30	Heat, uncovered, from refrig.
3½ oz.	Grilled Cheese	20-30	15-20	13-18	10-15	Heat, uncovered, from refrig.
4 oz.	Ham Sandwich	20-30	15-20	13-18	10-15	Heat, uncovered, from refrig.
4-5 oz.	Ham & Cheese	20-30	15-20	13-18	10-15	Heat, uncovered, from refrig.
5 oz.	Italian Sausage	30-40	24-28	21-25	20-24	Heat, uncovered, from refrig.
4-5 oz.	Pastrami	20-30	15-20	13-18	10-15	Heat, uncovered, from refrig.
4 oz.	Roast Beef	20-30	15-20	13-18	10-15	Heat, uncovered, from refrig.
4-5 oz.	Submarine/Hoagie	20-30	15-20	13-18	13-18	Heat, uncovered, from refrig.
5 oz.	Chili Burger	38-43	28-33	24-29	20-25	Heat, covered, from refrig.
4 oz.	Chili Dog	20-30	15-20	13-18	10-15	Heat, covered, from refrig.
4 oz.	Sloppy Joe	20-30	15-20	13-18	10-15	Heat, covered, from refrig.
Casseroles						
8 oz.	Baked Beans	70-80	45-50	40-45	40-45	Heat, covered, from refrig. Stir.
8 oz.	Beef Burgundy	80-90	55-60	48-53	50-55	Heat, covered, from refrig. Stir.
8 oz.	Beef Goulash	70-80	45-50	40-45	40-45	Heat, covered, from refrig. Stir.
8 oz.	Beef Stew	80-90	55-60	48-53	50-55	Heat, covered, from refrig. Stir.
8 oz.	Beef Slices with Gravy	70-80	45-50	40-45	40-45	Heat, covered, from refrig.
8 oz.	Cabbage Rolls	80-90	55-60	48-53	50-55	Heat, covered, from refrig.
8 oz.	Chicken Fricassee	70-80	45-50	40-45	40-45	Heat, covered, from refrig.
8 oz.	Chicken a la King	60-70	40-45	35-40	35-40	Heat, covered, from refrig. Stir.
8 oz.	Chili Con Carne	70-80	60-65	55-60	50-55	Heat, covered, from refrig. Stir.
8 oz.	Creamed Chicken	70-80	45-50	40-45	35-40	Heat, covered, from refrig. Stir.
8 oz.	Lasagna	85-95	60-65	52-58	45-50	Heat, covered, from refrig.
8 oz.	Meat Loaf	80-90	50-60	43-47	40-45	Heat, covered, from refrig.
8 oz.	Macaroni (beef sauce)	65-75	60-65	55-60	50-55	Heat, covered, from refrig. Stir.

Heating and Cooking Time Guide Con't

Quantity	Item	Approximate Heating Time 100% Power(seconds)				Comment:
		R-22GV R-22GT	R-23GT	R-24GT	R-25JT	
8 oz.	Macaroni (cheese sauce)	65-75	40-45	35-40	50-55	Heat, covered, from refrig. Stir.
8 oz.	Stuffed Peppers	85-95	60-65	52-58	50-58	Heat, covered, from refrig.
8 oz.	Pot Pie	80-90	55-60	48-53	40-45	Heat, covered, from refrig.
8 oz.	Ravioli	80-90	55-60	48-53	40-45	Heat, covered, from refrig.
8 oz.	Shrimp Creole	60-70	40-45	35-40	30-35	Heat, covered, from refrig.
8 oz.	Shrimp Newburg	60-70	40-45	35-40	30-35	Heat, covered, from refrig.
8 oz.	Short Ribs of Beef	80-90	65-70	55-60	50-55	Heat, covered, from refrig.
8 oz.	Spaghetti	60-70	58-65	55-60	50-55	Heat, covered, from refrig.
8 oz.	Stew, Chicken	80-90	65-70	55-60	50-55	Heat, covered, from refrig.
8 oz.	Tuna Casserole	80-90	65-70	55-60	50-55	Heat, covered, from refrig.
8 oz.	Turkey Slices	70-80	45-50	40-45	35-40	Heat, covered, from refrig.

Vegetables

4 oz.	Asparagus	30-40	20-25	15-20	10-15	Heat, covered, from refrig.
4 oz.	Beans, Green	30-40	20-25	15-20	10-15	Heat, covered, from refrig.
4 oz.	Broccoli	30-40	20-25	15-20	10-15	Heat, covered, from refrig.
4 oz.	Carrot Slices	40-50	35-40	30-35	25-30	Heat, covered, from refrig.
4 oz.	Cauliflower	40-50	35-40	30-35	25-30	Heat, covered, from refrig.
4 oz.	Corn Niblets	30-40	20-25	15-20	10-15	Heat, covered, from refrig.
4 oz.	Mushrooms	20-30	15-20	13-18	8-15	Heat, covered, from refrig.
4 oz.	Peas	20-30	15-20	13-18	8-15	Heat, covered, from refrig.
4 oz.	Potatoes au Gratin	40-50	30-40	25-35	15-25	Heat, covered, from refrig.
8 oz.	Potatoes (pre-baked)	70-80	53-58	47-52	40-45	Heat, uncovered, from refrig.

Quantity	Item	Approximate Heating Time 100% Power				Comment:
		R-22GV R-22GT	R-23GT	R-24GT	R-25JT	
Plated Meals						
1 small	Plated Meal	1½-2 min.	1-1½ min.	50-70 sec.	35-45 sec.	Heat, covered, from refrig.
1 large	Plated Meal	2-3 min.	2¼-2¾ min.	2-2½ min.	1¼-1¾ min.	Heat, covered, from refrig.
Primary Cooking						
4 slices	Bacon	1¾-2 min.	1½-1¾ min.	1¼-1½ min.	1-1¼ min.	Cook between paper towels.
1 pound	Bacon (precook to reheat)	5 min.	3½ min.	3 min.	2½-3 min.	Cook between paper towels.
2	Scrambled Eggs	50-60 sec.	35-40 sec.	30-35 sec.	25-30 sec.	Stir during cooking.
12	Scrambled Eggs (precook to reheat)	4½-5 min.	3½ min.	3 min.	2-2½ min.	Stir during cooking.
1 ear	Corn on the Cob	1½-2 min.	1¼-1¾ sec.	1-1½ min.	40-50 sec.	Cover, turn over during cooking.
1 medium	Potato	4 min.	3 min.	2½ min.	1½-1¾ min.	Wash, dry, prick.
2 medium	Potatoes	7¼ min.	5¼ min.	5 min.	2½-3 min.	Wash, dry, prick.
40 oz.	Frozen Broccoli Pieces	11 min.	9 min.	8½-9 min.	7-7½ min.	Rearrange during cooking.
24 oz.	Frozen Broccoli Spears	6 min.	4 min.	3½ min.	3 min.	Rearrange during cooking.
96 oz.	Refrigerated Lasagna	(R-22GV) 12 min. at 100 % (R-22GT) 30 min. at 50 %	25 min. at 50%	21 min. at 40 %	15 min. at 40 %	Cover with lid for first half of cooking time. Uncover for second half of cooking time. After cooking, allow to stand, covered, for least 5 minutes to make cutting and serving easier.

REMINDERS

1. Do not operate the oven empty. Either food or water should always be in the oven during operation to absorb microwave energy.
2. Limit use of metal to those specific examples given in this booklet. Generally, metal should not be used in the microwave oven during operation.
3. Do not heat eggs in the shell. Pressure will build up inside the shell and it will explode. Do not reheat cooked eggs unless they are scrambled or chopped. Puncture the yolk before heating eggs.
4. Do not heat oil or fat for deep fat frying.
5. Pierce the "skin" of potatoes, whole squash, apples or any fruit, vegetable or meat with a skin covering before heating.
6. Use only popcorn packaged in special microwavable packages. Pop using 100% power. Listen carefully when popping corn. When popping slows to one or two seconds between pops, remove from oven. Should you ever smell scorching, remove bag from oven immediately. If any unpopped kernels remain, do not try to re-pop; it may cause a fire.
7. Do not use paper towels, plates or other utensils made from recycled paper for microwave heating. Recycled paper products may contain certain impurities which could cause the paper to ignite during microwave heating.
8. Stir liquids briskly before heating and allow to stand at least for 20 seconds after heating before stirring or drinking to avoid eruption.

SPECIFICATIONS

	R-22GV/R-22GT	R-23GT	R-24GT	R-25JT
AC Line Voltage	Single phase 120V, 60Hz, A.C. only	Single phase 230/208V, 60Hz, A.C. only	Single phase 230/208V, 60Hz, A.C. only	Single phase 230/208V, 60Hz, A.C. only
AC Power Required	2.0 kW 17.7A	2.5 kW 230V-11.9A 208V-13.3A	2.9 kW 230V-13.1A 208V-14.6A	3.2 kW 230V-14.5A 208V-15.5A
Output Power Frequency	1200W★ 2450 MHz	1600W★ 2450 MHz	1800W★ 2450 MHz	2100W★ 2450 MHz
Outside Dimensions	20 ¹ / ₈ "(W) x 18 ¹ / ₂ "(D) x 13 ¹ / ₄ "(H) 510mm(W) x 470mm(D) x 335mm(H) (including feet)			
Cavity Dimensions	13"(W) x 13"(D) x 7 ¹ / ₈ "(H) 330mm(W) x 330mm(D) x 180mm(H)			
Weight	Approx. 60 lbs/27 kg	Approx. 63 lbs/29 kg	Approx. 65 lbs/30 kg	Approx. 68 lbs/31 kg

★ IEC Test Procedure

The International Electrotechnical Commission's standardized method for measuring output wattage. This test method is widely recognized.

In Compliance with Standards set by

FCC – Federal Communications Commission Authorized.

DHHS – Complies with Department of Health and Human Services (DHHS) rule, CFR, Title 21 Chapter I, Subchapter J.



– This symbol on the nameplate means the product is certified by NSF International (NSF-4).



– This symbol on the nameplate means the product is listed by Underwriters Laboratories, Inc.

AUTO-TOUCH GUIDE

For more complete information and safety precautions, refer to your Operation Manual.

<p>MEMORY CHECK</p> <p>Suppose you want to know the information programmed into the memory.</p> <p>1. Touch CHECK pad.</p> <p>2. Touch NUMBER pad 1.</p>	<p>CHECK</p> <p>1</p>	<p>COUNTER CHECK</p> <p>1. Touch CHECK pad 2 times.</p> <p>Total count will be displayed.</p>	<p>CHECK X 2</p>
<p>MULTIPLE SEQUENCE COOKING (R-22GT/23GT/24GT/25JT)</p> <p>Suppose you want to cook for 4 minutes at 60% and then continue to cook for 2 minutes at 30%.</p> <p>1. Enter cooking time for 1st stage.</p> <p>2. Enter power level for 1st stage.</p> <p>3. Enter cooking time for 2nd stage.</p> <p>4. Enter power level for 2nd stage.</p> <p>5. Touch START pad.</p>	<p>SELECTATIME</p> <p>4 0 0</p> <p>SELECTAPOW</p> <p>6</p> <p>SELECTATIME</p> <p>2 0 0</p> <p>SELECTAPOW</p> <p>3</p> <p>START</p>	<p>Count of memory 1, etc.</p> <p>Count of manual cooking</p> <p>Count of EXPRESS DEFROST</p>	<p>1</p> <p>SELECTATIME</p> <p>EXPRESS DEFROST</p>
		<p>To clear the number of times:</p> <p>Suppose you want to clear the times of memory 1.</p> <p>1. Touch CHECK pad 2 times.</p> <p>2. Touch NUMBER pad 1.</p> <p>3. Touch SET pad.</p> <p>Any count can be canceled by touching the SET pad during the checking mode.</p>	<p>CHECK X 2</p> <p>1</p> <p>SET</p>

AUTO-TOUCH GUIDE

For more complete information and safety precautions, refer to your Operation Manual.

<p>COOK WITH MEMORY</p> <p>Suppose you want to cook by using memory</p> <p>1. Touch number pad 1. (For R-22GT/23GT/24GT/25JT only)</p> <p>If you want to use memory 11-20, touch desired number pad twice within 1 second.</p>	<p style="text-align: center;">1</p>	<p>TIME COOKING</p> <p>Suppose you want to cook for 2 minutes and 30 seconds at 50%.</p> <p>1. Touch SELECTATIME</p> <p>2. Enter cooking time.</p> <p>3. Touch SELECTAPOW (except R-22GV)</p> <p>4. Enter power level. (except R-22GV)</p> <p>5. Touch START pad.</p>	<p style="text-align: center;">SELECTATIME</p> <p style="text-align: center;">2 3 0</p> <p style="text-align: center;">SELECTAPOW</p> <p style="text-align: center;">5</p> <p style="text-align: center;">START</p>
<p>COOKING DOUBLE QUANTITY WITH MEMORY</p> <p>Suppose you want to cook 2 servings by memory 1.</p> <p>1. Place food in oven. Touch Double Quantity pad.</p> <p>2. Touch number pad 1.</p>	<p style="text-align: center;">DOUBLE QUANTITY</p> <p style="text-align: center;">1</p>	<p>EXPRESS DEFROST</p> <p>Suppose you want to defrost for 3 minutes and 30 seconds.</p> <p>1. Touch EXPRESS DEFROST pad.</p> <p>2. Enter desired defrost time. (Refer to Express Defrost Chart on page 12.)</p> <p>3. Touch START pad.</p> <p>4. Midway through the defrosting cycle, CHECK will light in the display and an audible signal will be heard. You may open the door, turn food over and shield any warm portions. Close the door.</p> <p>5. Touch START pad.</p>	<p style="text-align: center;">EXPRESS DEFROST</p> <p style="text-align: center;">3 3 0</p> <p style="text-align: center;">START</p> <p style="text-align: center;">START</p>
<p>MEMORY PROGRAM ENTRY</p> <p>Suppose you want to set 4 minutes at 60% for the 1st stage for 1 serving in the memory 1.</p> <p>1. Touch SET pad 2 times within 2 seconds.</p> <p>2. Touch number pad 1.</p> <p>3. Enter cooking time.</p> <p>4. Enter power level.</p> <p>5. Touch SET pad 2 times.</p>	<p style="text-align: center;">SET X 2</p> <p style="text-align: center;">1</p> <p style="text-align: center;">SELECTATIME</p> <p style="text-align: center;">4 0 0</p> <p style="text-align: center;">SELECTAPOW</p> <p style="text-align: center;">6</p> <p style="text-align: center;">SET X 2</p>		

SHARP®

SHARP ELECTRONICS CORPORATION
Sharp Plaza, Mahwah, New Jersey 07430-2135

SHARP CORPORATION
Osaka, Japan

Printed with soy ink recycled paper
TINSEB105WRRZ-D51 Printed in Japan
2005.7