

SHARP®

PN-E471R
PN-E421

LCD MONITOR

OPERATION GUIDE

HDMI™
HIGH-DEFINITION MULTIMEDIA INTERFACE

Contents

Part Names	3
Basic Operation	5
Menu Items	7
Displaying the menu screen	7
List of menu items	8
Menu item details	10
Adjustments for PC screen display	16
Initialization (Reset)/Functional Restriction Setting (FUNCTION)	17
Controlling the Monitor with a PC (RS-232C)	18
PC connection	18
Communication conditions	18
Communication procedure	18
Setting of the GAMMA user data	21
RS-232C command table	22
Controlling the Monitor with a PC (LAN)	29
Settings to connect to a LAN	29
Controlling with a PC	31
Troubleshooting	37
Specifications	38

This guide contains instructions regarding operation, settings, and similar details.
For instructions regarding connection and installation, refer to the included Operation Manual.

Manual Scope

- Microsoft, Windows and Internet Explorer are registered trademarks of Microsoft Corporation.
- HDMI, the HDMI Logo and High-Definition Multimedia Interface are trademarks or registered trademarks of HDMI Licensing LLC.
- Adobe, Acrobat, and Reader are either registered trademarks or trademarks of Adobe Systems Incorporated in the United States and/or other countries.
- This product comes with RICOH Bitmap Fonts produced and sold by RICOH COMPANY, LTD.
- All other brand and product names are trademarks or registered trademarks of their respective holders.
- Language of OSD menu used in this manual is English by way of example.
- Illustrations in this manual may not exactly represent the actual product or display.
- This manual assumes use in horizontal orientation, except where specifically noted.

Part Names

■ Front view

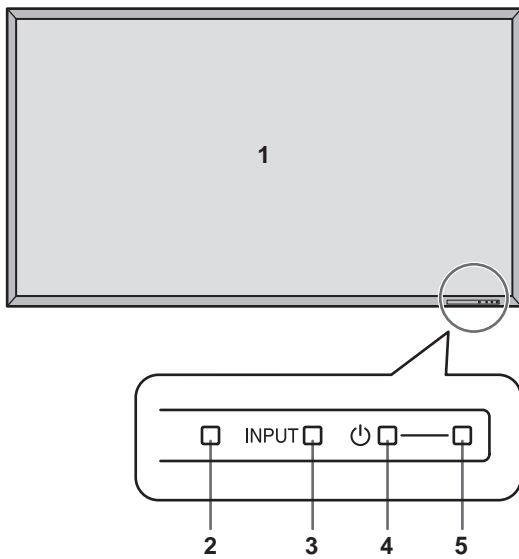

1. LCD panel
2. Remote control sensor
3. Input switch (See page 5.)
4. Power switch
5. Power LED

TIPS

- Use a pointed object such as a pen tip to press the switches at the front of the monitor.

■ Rear view

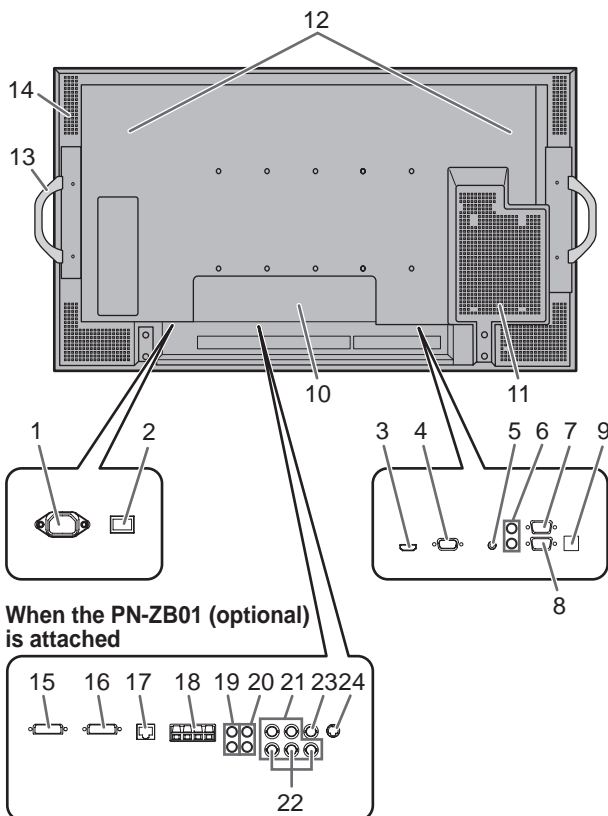

1. AC input terminal
2. Main power switch
3. PC/AV HDMI input terminal
4. PC D-sub input terminal
5. Audio input terminal
6. Audio output terminals
7. RS-232C output terminal
8. RS-232C input terminal
9. Optional terminal
This terminal is provided for possible future (optional) function expansion. Offering of this terminal is not a guarantee that future expanded functionality will be provided.
10. Expansion terminal cover
Additional input/output terminals are available by attaching the PN-ZB01 interface expansion board (optional).
11. Optional attachment section
This section is used to connect optional hardware for function expansion. Offering this attachment location is not a guarantee that future compatible hardware attachments will be released.
12. Speakers
13. Handles
14. Vents

When the PN-ZB01 (optional) is attached

15. PC/AV DVI-D input terminal
16. PC/AV DVI-D output terminal
17. LAN terminal
18. External speaker terminals
19. Audio 1 input terminals
20. Audio 2 input terminals
21. PC RGB input terminals
22. AV component input terminals
23. AV video input terminal
24. AV S-video input terminal

! Caution

- Consult your SHARP dealer for attachment/detachment of optional parts.
- Do not open the expansion terminal cover by yourself. There are high voltage parts inside the cover which may cause an electric shock.

■ Remote control unit

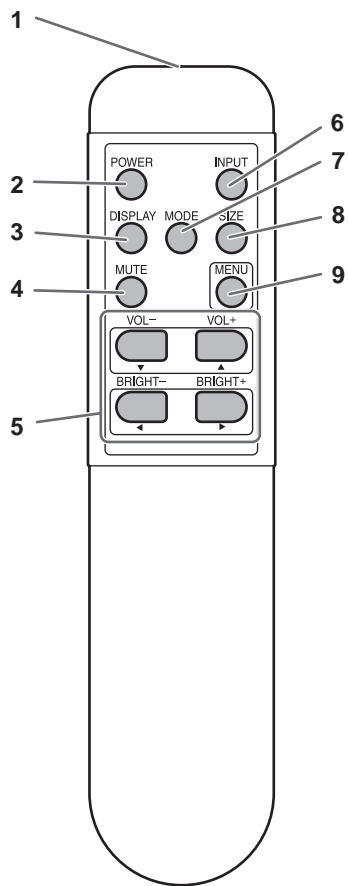

1. Signal transmitter
2. POWER button
3. DISPLAY button (See page 5.)
4. MUTE button (See page 5.)
5. VOL +/- buttons (See page 5.)
BRIGHT +/- buttons (See page 5.)
Cursor control (▲ / ▼ / ◀ / ▶) buttons
6. INPUT button (See page 5.)
7. MODE button (See page 5.)
8. SIZE button (See page 5.)
9. MENU button (See page 5.)

Basic Operation

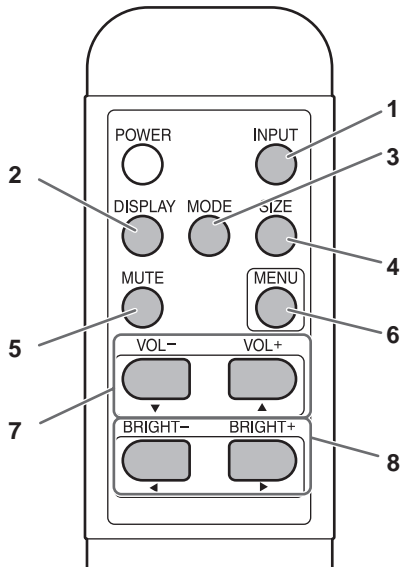

1. INPUT (Input mode selection)

The menu is displayed. Press or to select the input mode, and press to enter.

* You can select the input terminal by pressing the input switch of the monitor.

Input mode	Video	Audio
PC D-SUB	PC D-sub input terminal	Audio input terminal
PC HDMI	PC/AV HDMI input terminal ^{*1}	*2
AV HDMI	PC/AV HDMI input terminal ^{*1}	

When the PN-ZB01 (optional) is attached

Input mode	Video	Audio
PC DVI-D	PC/AV DVI-D input terminal ^{*3}	*2
PC HDMI	PC/AV HDMI input terminal ^{*1}	
PC D-SUB	PC D-sub input terminal	
PC RGB	PC RGB input terminals ^{*4}	
AV DVI-D	PC/AV DVI-D input terminal ^{*3}	
AV HDMI	PC/AV HDMI input terminal ^{*1}	
AV COMPONENT	AV COMPONENT input terminals ^{*4}	
AV S-VIDEO	AV S-video input terminal	
AV VIDEO	AV video input terminal	

*1 Select the terminal to be used in HDMI of INPUT SELECT. (See page 12.)

*2 Select the terminal for AUDIO SELECT which is used for audio input. (See page 12.)

*3 Select the terminal to be used in DVI of INPUT SELECT. (See page 12.)

*4 Select the terminal to be used in BNC of INPUT SELECT. (See page 12.)

2. DISPLAY

Displays monitor information. When you press this button again, the display disappears.

When the PN-ZB01 (optional) is attached, the display changes from INFORMATION1 → INFORMATION2 → clear display, and so on every time you press this button.

- The display disappears automatically after about 15 seconds.
- LAN is displayed during LAN communication.
- If LAN is displayed in red, there is a duplicate IP address.

3. MODE (Color mode selection)

Each time you press this button, the color mode changes in the following order:

STD (Standard) → VIVID → sRGB → STD...

- sRGB applies to PC input only.
sRGB is international standard of color representation specified by IEC (International Electrotechnical Commission). Color conversion is made in taking account of liquid crystal's characteristics and represents color tone close to its original image.

4. SIZE (Screen size selection)

The menu is displayed.

Press or to select the screen size. (See page 6.)

5. MUTE

Turns off the volume temporarily.

Press the MUTE button again to turn the sound back to the previous level.

6. MENU

Displays and turns off the menu screen (see page 7).

7. VOL +/- (Volume adjustment)

Pressing or displays the VOLUME menu when the menu screen is not displayed.

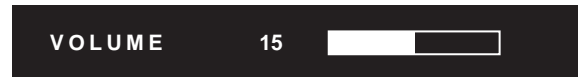

Press or to adjust the volume of the sound.

* If you do not press any buttons for about 4 seconds, the VOLUME menu automatically disappears.

8. BRIGHT +/- (Backlight adjustment)

Pressing or displays the BRIGHT menu when the menu screen is not displayed.



Press or to adjust the brightness.

* If you do not press any buttons for about 4 seconds, the BRIGHT menu automatically disappears.

Basic Operation

■ Switching the screen size

Even when the screen size is changed, the display may remain the same depending on the input signal.

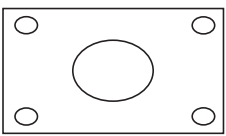
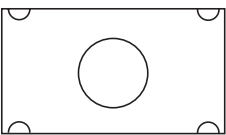
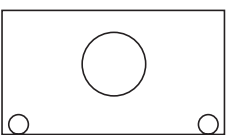
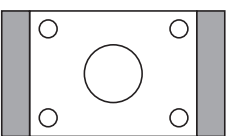
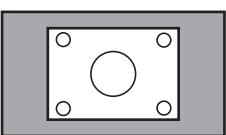
WIDE		PC input	Displays image so it fills the entire screen.
		AV input	An image with a 4:3 aspect ratio is stretched to fill the entire screen.
ZOOM 1		PC input	An image with a 4:3 aspect ratio is enlarged to fill the entire screen without changing the aspect ratio. The edges of the image may be cut off.
		AV input	
ZOOM 2		PC input	Use this size if ZOOM 1 cuts off the subtitles.
		AV input	
NORMAL		PC input	Displays image so it fills the screen without changing the aspect ratio of the input signals.
		AV input	Displays the entire image of the aspect ratio of 4:3 without changing the aspect ratio.
Dot by Dot		PC input	Displays the dots of the signals input from the connected PC as the corresponding dots on the screen. *
		AV input	Displays the dots of the input signals as the corresponding dots on the screen.

*: With a monitor of screen resolution 1600 x 1200 or 1920 x 1200, selecting Dot by Dot displays the NORMAL screen.

TIPS

- Using this monitor's screen-size switching or dual-screen display functions to compress or expand the screen for commercial or public viewing in establishments like cafes or hotels may infringe on the rights of the creators, as protected by Copyright Law, so please be careful.
- When "Enlarge" is set, the screen size is fixed to "WIDE" mode.
- When dual-screen display is selected, the screen size cannot be changed.
- The appearance of the original video may change if you select a screen size with a different aspect ratio than the original image (e.g. TV broadcast or video input from external equipment).
- When an ordinary non-wide image (4:3) is viewed with the whole screen using the screen-size switching function of this monitor, the edge of the image may be lost or appear distorted. If you wish to respect the creator's intentions, set the screen size to "NORMAL".
- When playing commercial software, parts of the image (like subtitles) may be cropped. In this case select the optimal screen size using the screen-size switching function of this monitor. With some software, there may be noise or distortion at the edges of the screen. This is due to the characteristics of the software, and is not a malfunction.
- Depending on the original image size, black bands may remain at the edges of the screen.

Menu Items

Displaying the menu screen

Video and audio adjustment and settings of various functions are enabled. This section describes how to use the menu items. See pages 10 to 13 for details of each menu items.

Caution

- Do not turn the main power switch off while the menu items are being displayed. Doing so may initialize the settings.

Example of operation

(Adjusting CONTRAST in the PICTURE menu)

- Press  to display the menu screen.

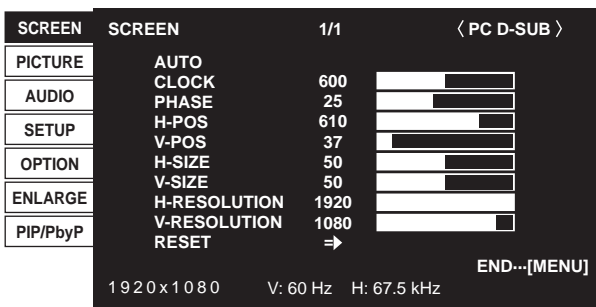

- Press  or  to select PICTURE, and press . PICTURE menu is displayed.

- Press  or  to select CONTRAST.

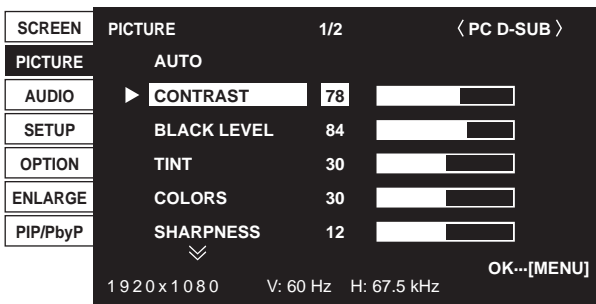

- Press  or  to adjust the setting.

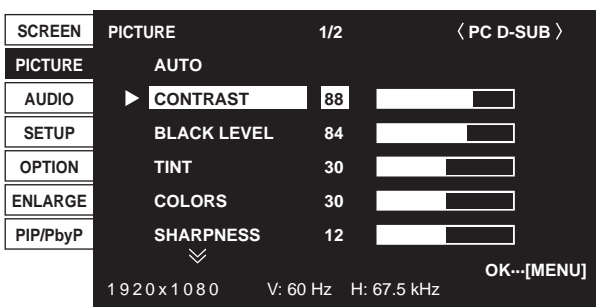

For items that have , press , make settings and then press .

- Press  twice to close the menu screen.

TIPS

- The menu will differ depending on the input mode.
- The menu screen will close automatically if no operation is performed for about 15 seconds. (DATE/TIME SETTING, SCHEDULE and LAN SETUP screens will close in about 4 minutes.)

Menu screen display

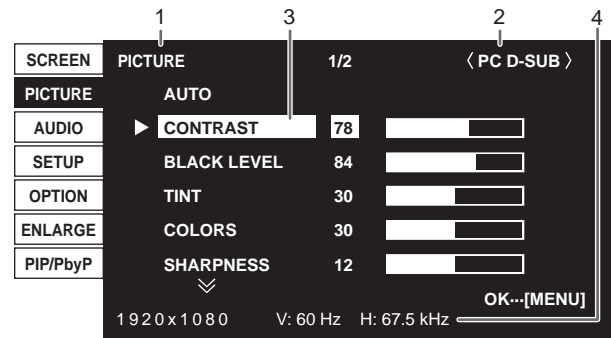

- Name of the menu
- Input mode
- An item being selected (highlighted)
- Screen resolution of input signal, and other data.

TIPS

- Items that cannot be selected appear in gray. (e.g. Function not supported by the current input signal)

Menu Items

List of menu items

The displayed menu items vary depending on whether or not the PN-ZB01 (optional) is attached.

○: Item is available, -: Item is not available.

Menu	Item	PN-ZB01 (optional)		
		Not attached	Attached	
SCREEN	AUTO	○	○	
	CLOCK	○	○	
	PHASE	○	○	
	H-POS	○	○	
	V-POS	○	○	
	H-SIZE	○	○	
	V-SIZE	○	○	
	H-RESOLUTION	○	○	
	V-RESOLUTION	○	○	
	RESET	○	○	
PICTURE	AUTO	○	○	
	CONTRAST	○	○	
	BLACK LEVEL	○	○	
	TINT	○	○	
	COLORS	○	○	
	SHARPNESS	○	○	
	ADVANCED	FLESH TONE	○	○
		3D-NR	○	○
		MPEG-NR	○	○
		3D-Y/C	-	○
		C.M.S.-HUE	○	○
		C.M.S.-SATURATION	○	○
		C.M.S.-VALUE	○	○
	COLOR MODE	○	○	
	WHITE BALANCE	○	○	
	PRESET	○	○	
	R-CONTRAST	○	○	
	G-CONTRAST	○	○	
	B-CONTRAST	○	○	
	COPY TO USER	○	○	
GAMMA	○	○		
RESET	○	○		
AUDIO	TREBLE	○	○	
	BASS	○	○	
	BALANCE	○	○	
	RESET	○	○	
SETUP	OSD H-POSITION	○	○	
	OSD V-POSITION	○	○	
	MONITOR	○	○	
	MONAURAL AUDIO	○	○	
	LANGUAGE	○	○	
	POWER ON DELAY	○	○	
	STANDBY MODE	○	○	
	HDMI SETTING	HDMI AUTO VIEW	○	○
		HDMI RGB INPUT RANGE	○	○
	HOT PLUG CONTROL	HDMI	○	○
		DVI	-	○
	RS-232C/LAN SELECT	-	○	
	ID No. SET	○	○	
	BAUD RATE	○	○	
	LAN SETUP	-	○	
	SPEAKER SELECT	-	○	
	OPTION DC OUT SETTING	○	○	

Menu	Item	PN-ZB01 (optional)		
		Not attached	Attached	
OPTION	DATE/TIME SETTING	○	○	
	SCHEDULE	○	○	
	INPUT SELECT	DVI	-	○
		BNC	-	○
		HDMI	○	○
	AUDIO SELECT	PC DVI-D	-	○
		PC HDMI	○	○
		PC D-SUB	-	○
		PC RGB	-	○
		AV DVI-D	-	○
		AV HDMI	○	○
		AV COMPONENT	-	○
		AV S-VIDEO	-	○
		AV VIDEO	-	○
	INPUT SIGNAL	480 LINES	○	○
		768 LINES	○	○
		1050 LINES	○	○
		ZOOM2 SPECIAL SETTING	○	○
	SCAN MODE	○	○	
	POWER MANAGEMENT	○	○	
	COLOR SYSTEM	-	○	
	AUDIO OUTPUT	○	○	
	AUDIO INPUT LEVEL	○	○	
SELF ADJUST	○	○		
AUTO INPUT CHANGE	○	○		
ENLARGE	ENLARGE H	○	○	
	ENLARGE V	○	○	
	ENLARGE-POS H	○	○	
	ENLARGE-POS V	○	○	
	BEZEL H	○	○	
	BEZEL V	○	○	
	H-POS	○	○	
	V-POS	○	○	
PIP/PbyP	PIP MODES	○	○	
	PIP SIZE	○	○	
	PIP H-POS	○	○	
	PIP V-POS	○	○	
	PIP BLEND	○	○	
	PIP SOURCE	-	○	
	SOUND CHANGE	○	○	
	MAIN POS	○	○	
	PbyP2 POS	○	○	
	AUTO OFF	○	○	

TIPS

- Some items may not be displayed depending on the input mode.

Menu Items

Menu item details

The menu will differ depending on the input mode.

■SCREEN

AUTO (PC D-SUB/PC RGB)

The CLOCK, PHASE, H-POS, and V-POS are automatically adjusted.

Pressing  performs adjustment.

Use this automatic adjustment when you use the PC D-sub input terminal or PC RGB input terminals to display a PC screen for the first time or when you change the setting of the PC. (See page 16.)

CLOCK (PC D-SUB/PC RGB)

Adjusts frequency for sampling clock for applicable video. Adjust when there is flickering in the form of vertical stripes. When using the adjustment pattern (see page 16), make adjustments so that no vertical stripe noise appears in it.

PHASE (PC D-SUB/PC RGB)

Adjusts sampling clock phase for applicable video.

Useful when small characters appear with low contrast and/or there are flickers at corners.

When using the adjustment pattern (see page 16), make adjustments so that no horizontal stripe noise appears in it.

* Adjustments to PHASE should be made only after CLOCK has been correctly set.

H-POS

Adjust the horizontal position of the image.

V-POS

Adjust the vertical position of the image.

H-SIZE

Adjust the horizontal size of the image.

V-SIZE

Adjust the vertical size of the image.

H-RESOLUTION (PC D-SUB/PC RGB)

Sets proper horizontal resolution when the resolution of input signals is not recognized properly. (Adjustment may be impossible with some signals.)

V-RESOLUTION (PC D-SUB/PC RGB)

Sets proper vertical resolution when the resolution of input signals is not recognized properly. (Adjustment may be impossible with some signals.)

RESET

Resets the values of the SCREEN menu items to the factory preset values.

Select "ON" and then press .

■PICTURE

AUTO (PC D-SUB/PC RGB)

The CONTRAST and BLACK LEVEL are automatically adjusted.

Pressing  performs adjustment.

CONTRAST

Adjusts the brightness of the image.

BLACK LEVEL

Adjusts the entire brightness of the video signals.

TINT

Adjusts the hue. Selecting + changes the color towards green, and selecting - changes it towards magenta.

COLORS

Adjusts the color intensity.

SHARPNESS

Adjusts the sharpness of the image.

ADVANCED (AV input)

You can adjust more specifically. (See page 16.)

COLOR MODE

Changes the color mode on the screen. The color mode on the screen can also be changed using a remote control unit. (See page 5.)

* sRGB is PC input only. See page 5 for details.

WHITE BALANCE

THRU..... Displays the input signal level as is. (for PC DVI-D/PC HDMI only)

PRESET Selects the color temperature using PRESET.

USER..... Used for adjusting R-CONTRAST, G-CONTRAST, and B-CONTRAST respectively.

PRESET

Selects the color temperature when the WHITE BALANCE is set to PRESET.

The setting values are shown for reference. The color temperature of the screen varies over time.

This function is not intended to keep the color temperature constant.

R-CONTRAST

Adjusts red component when the WHITE BALANCE is set to USER.

G-CONTRAST

Adjusts green component when the WHITE BALANCE is set to USER.

B-CONTRAST

Adjusts blue component when the WHITE BALANCE is set to USER.

COPY TO USER

Copies the value set for PRESET to the USER setting.

Select "ON" and then press .

GAMMA

Select a gamma value. USER sets the gamma value transferred by the user. (See page 21.)

RESET

Resets the values of the PICTURE menu items to the factory preset values.

Select "ON" and then press .

■AUDIO**TREBLE**

Adjusts the volume of treble-level sound.

BASS

Adjusts the volume of bass-level sound.

BALANCE

Adjusts the balance of the audio sound between right and left.

RESET

Resets the values of the AUDIO menu items to the factory preset values.
Select "ON" and then press .

■SETUP**OSD H-POSITION**

Adjusts the horizontal display position of menu screen.

OSD V-POSITION

Adjusts the vertical display position of menu screen.

MONITOR

Select the installation direction of the monitor.

LANDSCAPEHorizontal orientation

PORTRAITVertical orientation

MONAURAL AUDIO

Outputs audio signals as monaural.

LANGUAGE

Sets the display language for the menu screen.

POWER ON DELAY

You can delay the screen display after the monitor is turned on. The period can be set up to 60 seconds in units of one second. When this function is activated, the power LED flashes (at approx. 1 second interval) in orange. This function is disabled when 0 is specified.

STANDBY MODE

When STANDARD is selected, startup time from standby mode is reduced. Note, however that, more power will be consumed in standby mode.

When LOW POWER is selected, current consumption is reduced while the monitor is in standby mode. Note, however, that the startup time from standby mode becomes longer. Also, certain RS-232C commands cannot be used in standby mode, and control via LAN will be disabled. (See pages 22 and 29.)

HDMI SETTING**HDMI AUTO VIEW**

.....When ON is selected, the screen size is adjusted automatically according to the screen size control signal included in the video signal input from the AV HDMI input terminal.

HDMI RGB INPUT RANGE

.....Sets the type of HDMI signals when using the AV HDMI input mode.
When AUTO is selected, the type is set automatically.

HOT PLUG CONTROL

Sets whether to use hot plug control for the PC/AV HDMI and PC/AV DVI-D input terminals.

RS-232C/LAN SELECT

Selects the method with which to control the monitor from the computer.

ID No. SET

Assigns ID numbers to monitors connected in a daisy chain (see page 19), using RS-232 cables.

The numbers 1 to 255 are available for ID numbers.

If "0" is set, the system regards this as the state where no ID number is set.

BAUD RATE

Selects the communication speed used for RS-232C communication.

LAN SETUP

Configures the settings to control the monitor from the computer via LAN. (See page 29.)

SPEAKER SELECT

Selects the speaker to be used.

OPTION DC OUT SETTING





Normally, leave this setting as OFF.

When using an optional part, if instruction appears, change the setting accordingly.

Menu Items

■OPTION

DATE/TIME SETTING

Set the date and time. Press  or  to select the date and time, and press  or  to change the numerical values. Set the date in "Year/Month/Day" order. Set the time on a 24-hour basis.

SCHEDULE (See page 15.)

You can set the time to switch the monitor on and off.

INPUT SELECT

Select the input mode to be used in PC/AV DVI-D input terminal, PC/AV HDMI input terminal and PC RGB/AV component input terminals.

AUDIO SELECT

Selects the terminal used to input audio signals in each input mode.

INPUT SIGNAL (PC D-SUB/PC RGB)

If a computer connected to the PC D-sub/PC RGB input terminal outputs any of the following resolutions, make a selection from the following options.

480 LINESAUTO, 640x480 or 848x480
768 LINESAUTO, 1024x768, 1280x768, or 1360x768
1050 LINES1400x1050 or 1680x1050
ZOOM2 SPECIAL SETTING (See page 14.)

SCAN MODE (AV input)

Sets the scan mode used for AV mode input.

MODE1Over-scan display
MODE2Under-scan display
MODE3Under-scan display when the input signal is 1080i/p. Otherwise, over-scan display

* Even when MODE1 is selected, under-scan display is used when the input signal is 1080i/p and the screen size is Dot by Dot.

POWER MANAGEMENT

POWER MANAGEMENT determines whether or not to switch modes from no signal to the input signal standby mode.

COLOR SYSTEM (AV S-VIDEO/AV VIDEO)

Select the color system of the AV equipment which is connected to AV S-video and AV video input terminal. (AUTO / PAL / PAL-60 / SECAM / NTSC3.58 / NTSC4.43)
When AUTO is selected, the color system is automatically set according to the input signal.

AUDIO OUTPUT

Sets the volume of sound output from the audio output terminals.

VARIABLE You can adjust the volume using VOLUME.
FIXED Fixes the sounds.

AUDIO INPUT LEVEL

Selects the maximum audio input level of the audio input terminal.

SELF ADJUST

On a PC D-SUB/PC RGB screen, specify whether to perform screen adjustment automatically or not. When ON is selected, the screen is automatically adjusted when its resolution is 800 x 600 or higher and the timing of input signals changes. "ADJUSTING" appears on the screen during the adjustment. Depending on the signal, adjustment may not be possible. In this case select OFF. (Perform manual adjustment of the screen.)

AUTO INPUT CHANGE

Specify whether to change inputs automatically. When ON is selected and no signal is present in the selected input mode, AUTO INPUT CHANGE automatically changes the selected mode to another mode where a video signal is present. When video signals exist in multiple input modes, the switching priority is as follows:

PC D-SUB, PC HDMI and AV HDMI

When the PN-ZB01 (optional) is attached:

PC DVI-D, PC HDMI, PC D-SUB, PC RGB, AV DVI-D, AV HDMI, AV COMPONENT, AV S-VIDEO and AV VIDEO
(Input mode switching may take 15 seconds or more, depending on the connected equipment. Input signals may not be detected properly and a priority may change, depending on the connected equipment or video signals.)

■ENLARGE (PC input)

ENLARGE H

Sets the number of screen splits (number of monitors) in the horizontal direction used for the enlargement. (See page 14.)

ENLARGE V

Sets the number of screen splits (number of monitors) in the vertical direction used for the enlargement. (See page 14.)

ENLARGE-POS H / ENLARGE-POS V

Specify the split screen to be displayed when the enlargement function is used. (See page 14.)

BEZEL H / BEZEL V

Sets the frame width of the display when the enlargement function is used.

H-POS

Adjust the horizontal position of the enlarged screen.

V-POS

Adjust the vertical position of the enlarged screen.

■ PIP/PbyP

PIP MODES

Sets the display method.

OFFDisplays one screen.

PIP.....Displays a sub screen inside a main screen.

PbyP.....Displays a main screen and a sub screen in a line.

PbyP2.....Displays a main screen which measures 1280 pixels in the longest direction and a sub screen in a line.

PIP SIZE

Sets the size of the sub screen in PIP mode.

PIP H-POS

Adjusts the horizontal position of the sub screen in PIP mode.

PIP V-POS

Adjusts the vertical position of the sub screen in PIP mode.

PIP BLEND

In PIP mode, use this menu item to display the sub screen transparently.

PIP SOURCE

Selects the input signal of the sub screen in PIP, PbyP, or PbyP2 mode.

SOUND CHANGE

Sets the sound which is output in PIP, PbyP, or PbyP2 mode. If the main screen is displayed as a full screen by the AUTO OFF function, the sound for the main screen is output even when the sound for the sub screen is specified.

MAIN POS

Sets the position of the main screen in PbyP or PbyP2 mode.

PbyP2 POS

Sets the position of the sub screen in PbyP2 mode.

AUTO OFF

Sets the display method when no signals for the sub screen are input in PIP, PbyP, or PbyP2 mode.

MANUAL..... Displays a main screen and a black sub screen.

AUTO..... Displays the main screen as a full screen.

TIPS

- When WHITE BALANCE is set to THRU, BLACK LEVEL, CONTRAST, TINT, COLORS and GAMMA cannot be set.
- If COLOR MODE is set to sRGB or VIVID, the following items cannot be set.
WHITE BALANCE, PRESET, R-/G-/B-CONTRAST, COPY TO USER, and GAMMA
- If GAMMA is set to USER, the following items cannot be set.
WHITE BALANCE, PRESET, R-/G-/B-CONTRAST, and COPY TO USER
- STANDBY MODE cannot be set to LOW POWER when SCHEDULE is effective or when OFF is selected for LED in FUNCTION.

■ Dual screen display

You can display the screens of the PC input signal and AV input signal simultaneously.

Set this function with "PIP MODES" in the PIP/PbyP menu.

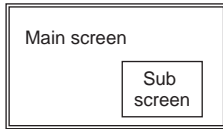
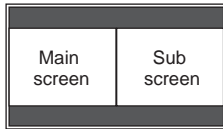
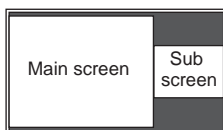
PIP		A sub screen is displayed inside a main screen.
PbyP		A main screen and a sub screen are displayed in a line.
PbyP2		Displays a main screen which measures 1280 pixels in the longest direction and a sub screen in a line.

- * The currently selected input signal is displayed on the main screen.
- * You cannot simultaneously display the screens of signals of the same type, such as two types of PC input signals or two types of AV input signals.
- * The dual screen display cannot be used with the combination of PC DVI-D and AV HDMI or of AV DVI-D and PC HDMI.

TIPS

- You might infringe on a copyright of the author which is protected by copyright law when you display the images of the computer screen and television/VCR simultaneously for profit-making or to show the image to the public.
- The screen size for dual-screen display is the same as the screen size for single-screen display. The Dot by Dot screen is displayed in NORMAL size except when it is set as the PIP main screen.
- When dual-screen display is selected, the AUTO INPUT CHANGE function is disabled.
- When dual-screen display is selected, the screen cannot be enlarged.
- When dual-screen display is selected, the INPUT SELECT options cannot be set.

Menu Items

■Enlarge

- You can align several monitors and integrate them into a single large screen to display.
- Up to five monitors can be aligned in both the horizontal and vertical directions.
- Each monitor displays enlarged views of separated images.

(Example)

Horizontal direction: 2 monitors

Vertical direction: 2 monitors

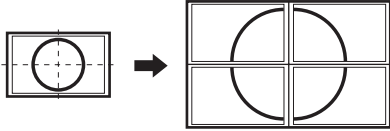

Horizontal direction: 3 monitors

Vertical direction: 2 monitors

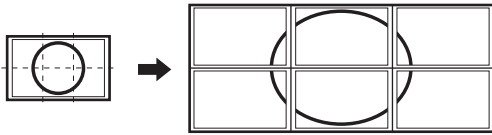

Setting procedure

In the ENLARGE menu, set ENLARGE H/V and ENLARGE-POS H/V. (See page 12.)

1. Set the number of monitors aligned in the horizontal direction in ENLARGE H.
2. Set the number of monitors aligned in the vertical direction in ENLARGE V.
3. Set the section of the separated image to be displayed on each monitor in ENLARGE-POS H and ENLARGE-POS V.

In horizontal orientation

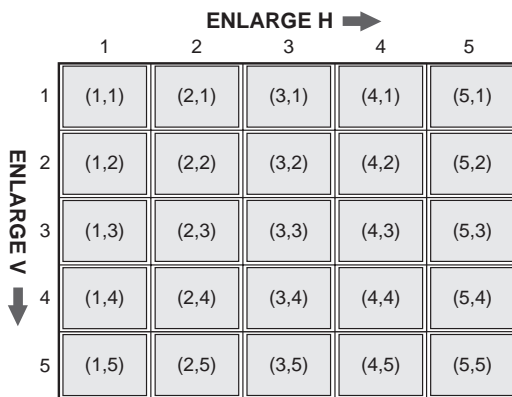

In vertical orientation

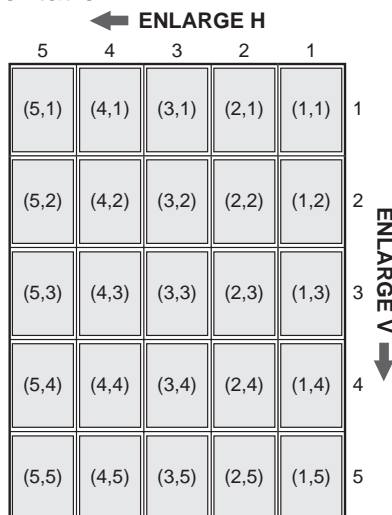

* The numbers in parentheses are the setting values in (ENLARGE-POS H, ENLARGE-POS V) format.

TIPS

- AV input signals cannot be used for the Enlarge function.
- When Enlarge is used, the AUTO INPUT CHANGE function is disabled.
- To cancel the enlargement, set 1 for ENLARGE H and ENLARGE V respectively.

■ZOOM2 SPECIAL SETTING

If you connect a laptop computer with any of the following screen resolutions and black bands appear around the screen, set ZOOM2 SPECIAL SETTING of INPUT SIGNAL on the OPTION menu to ON and then select ZOOM2 in the SIZE setting.

This displays the area inside the black band.

Laptop computer resolution	Corresponding signal*1
1280x800	1280x1024, 1280x960, 1400x1050*2
1280x600	1280x720
1024x600	1024x768

*1: This setting is effective only when the screen resolution, including the black band, is one of the resolutions listed above.

*2: Use the automatic screen adjustment.

■ SCHEDULE

You can set the time to switch the monitor on and off.
Set this function with "SCHEDULE" in the OPTION menu. (See page 12.)

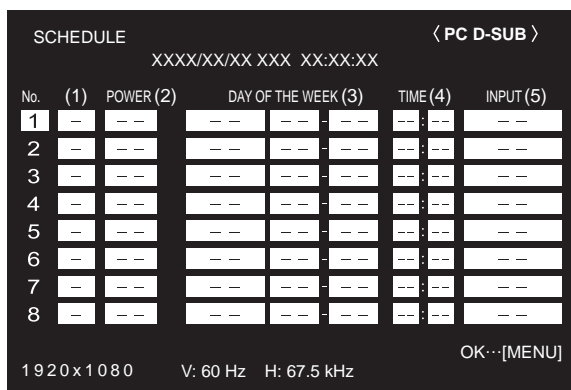

- Press or to select the SCHEDULE number, and press .
- Set the SCHEDULE. (See the description below.)
Press or to select items, and press or to change the setting.
- Press .
SCHEDULE becomes effective.

(1)

- : SCHEDULE effective
- : SCHEDULE not effective

(2) POWER

ON : Switches the monitor on at the specified time.
OFF : Switches the monitor off at the specified time and puts the monitor in standby mode.

(3) DAY OF THE WEEK

Specifies the day of the week to execute the SCHEDULE.

ONLY ONCE:

Executes the SCHEDULE once on the specified day.
Specify the day of the week to execute the SCHEDULE.

EVERY WEEK:

Executes the SCHEDULE on the specified day of the week every week. Specify the day of the week to execute the SCHEDULE.

Periodic setting such as "Monday through Friday" is also possible.

EVERY DAY:

Executes the SCHEDULE every day regardless of the day of the week.

(4) TIME

Specifies the time to execute the SCHEDULE.
Set the time on a 24-hour basis.

(5) INPUT

Specifies the input mode at power-on. When not specifying, the screen at the previous power-off appears.

Input modes displayed on DVI, HDMI and BNC depend on INPUT SELECT settings.

! Caution

- Do not switch off the main power after setting the SCHEDULE.
- Specify the correct date and time. (See page 12.)
SCHEDULE does not function unless the date and time are specified.
- Check regularly that the set date and time are correct.
- When STANDBY MODE is LOW POWER, SCHEDULE cannot be set.

TIPS

- Up to 8 SCHEDULE items can be registered.
- Setting the SCHEDULE flashes the power LED alternately in red and orange in standby mode.
- A SCHEDULE that has a large number has precedence over that of a small number when schedules overlap.

■ADVANCED items (AV input) (See page 10 for additional Menu item details.)

FLESH TONE

Adjust the hue control.

3D-NR

Reduce the noise of playback images on video. Setting a higher level reduces more noise. However, it may cause blurring on an image.

MPEG-NR

Reduce block noise caused by digital compression.

3D-Y/C (AV VIDEO)

Specify whether to perform 3-dimension Y/C separation. If dot interference or cross-color is occurring in fast-motion scenes, selecting "OFF" may improve the image quality.

C.M.S.-HUE

Adjusts color tone with 6 colors of R (red), Y (yellow), G (green), C (cyan), B (blue), and M (magenta).

C.M.S.-SATURATION

Adjusts color vividness with 6 colors of R (red), Y (yellow), G (green), C (cyan), B (blue), and M (magenta).

C.M.S.-VALUE

Adjusts color brightness with 6 colors of R (red), Y (yellow), G (green), C (cyan), B (blue), and M (magenta).





TIPS

- When FLESH TONE is set to LOW or HIGH, C.M.S.-HUE/-SATURATION/-VALUE cannot be set.

Adjustments for PC screen display

■Automatic adjustment

When you use the PC D-sub input terminal or PC RGB input terminals to display a PC screen for the first time, or when you change the setting of the PC, use the automatic screen adjustment.

1. Switch the input to PC D-SUB or to PC RGB and display the adjustment pattern. (See the description below.)
2. Press  and use  or  to display the SCREEN menu.
3. Press  and select "AUTO".
4. Press .

The automatic adjustment is complete in several seconds.
5. Press  twice to close the menu screen.

TIPS

- If the screen cannot be adjusted properly with one automatic adjustment, repeat the automatic adjustment two or three times. Try manual adjustment if necessary.

■Screen display for adjustment

Before making adjustments in the SCREEN menu or PICTURE menu, display an image to brighten the entire screen. If you are using a Windows PC, use the adjustment pattern on the supplied CD-ROM.

Opening the adjustment pattern

The following example is performed in Windows XP.

1. Load the supplied CD-ROM into the computer's CD-ROM drive.
2. Open the CD-ROM in [My Computer].
3. Double-click [Adj_uty.exe].

The adjustment pattern will appear.
Adjust the screen automatically or manually.

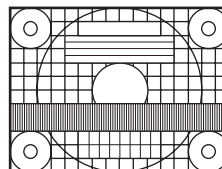

4. When adjustment is finished, press the [Esc] on the computer's keyboard to quit the adjustment program.
5. Eject the CD-ROM from the CD-ROM drive.

TIPS

- If the display mode on the computer you are using is 65,000 colors, the color levels in the color pattern may appear differently or grayscale may appear to be colored. (This is due to the specifications of the input signal and is not a malfunction.)

Initialization (Reset)/Functional Restriction Setting (FUNCTION)

You can return the settings to their factory-preset values and restrict operations.

1. After pressing **SIZE** for about 5 seconds, press **▲**, **▶**, **▼**, and **◀** in that order.

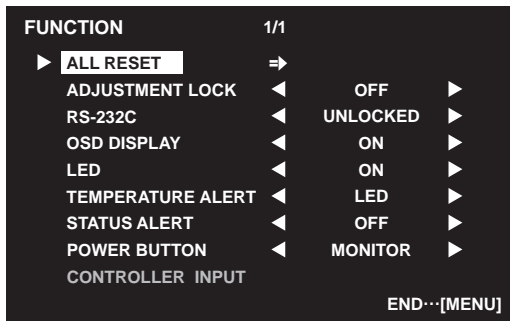

2. Select and set the items.

ALL RESET

Resets the settings to the factory default settings.

Press **▶**, select ALL RESET, and then press **MENU**.

After initialization, turn the main power switch off and then back on.

When the PN-ZB01 (optional) is attached, press **▶**, select the resetting method, and then press **MENU**.

ALL RESET1Resets all the settings to the factory default settings.

ALL RESET2Returns all settings to the factory default settings except for the following items:
LAN SETUP, RS-232C/LAN SELECT, ID No. SET, BAUD RATE, NETWORK, MAIL, SERVICE & SUPPORT, and SNMP (See page 11, and pages 33 to 36.)

ADJUSTMENT LOCK

You can disable operations on the monitor and the remote control unit that use buttons.

OFF ... Enables operation.

1.....Disables all operations other than turning power on/off and FUNCTION.

2..... Only the FUNCTION operation is enabled.
Disables all operations other than FUNCTION (not even power on/off).

RS-232C

(RS-232C/LAN when the PN-ZB01 (optional) is attached)

Specifies whether to allow control via RS-232C or LAN (see pages 18 and 29).

OSD DISPLAY

Hides/shows menus.

The FUNCTION screen cannot be hidden.

LED

Specifies whether to light the power LED.

OFF cannot be selected when STANDBY MODE is LOW POWER.

TEMPERATURE ALERT

Selects the notification method for an abnormal temperature.

OFF Do not notify about an abnormal temperature.

OSD & LED .. When an abnormal temperature is detected, the power LED flashes in red and green alternately and the screen displays a message: TEMPERATURE.

LED..... When an abnormal temperature is detected, the power LED flashes in red and green alternately.

STATUS ALERT

Selects the notification method for a hardware error.

OFF Do not notify about the error.

OSD & LED .. When a hardware error is detected, the power LED flashes in red and the screen displays a message: STATUS [xxxx].

LED..... When a hardware error is detected, the power LED flashes in red.

POWER BUTTON

Normally, leave this setting as MONITOR.

When using an optional part, if instruction appears, change the setting accordingly.

CONTROLLER INPUT

Normally, you do not need to change this setting.

When using an optional part, if instruction appears, change the setting accordingly.

3. Press **MENU** to return to the normal screen.

TIPS

- When both abnormal temperature and hardware error are detected, the hardware error notification overrides.

Controlling the Monitor with a PC (RS-232C)

You can control this monitor from a PC via RS-232C (COM port) on the PC.

You can also connect multiple monitors via a daisy chain by using a PC. By assigning ID numbers to each monitor (see page 19), you can make input mode selection/adjustment or can check the status of a specific monitor.

Precautions when the PN-ZB01 (optional) is attached

- To control the monitor via RS-232C, set RS-232C/LAN SELECT to RS-232C.
- You cannot use RS-232C and LAN control simultaneously.

PC connection

One-to-one connection with a PC

Connect with RS-232 straight cable between the PC's COM port (RS-232C connector) and the RS-232C input terminal on the monitor.

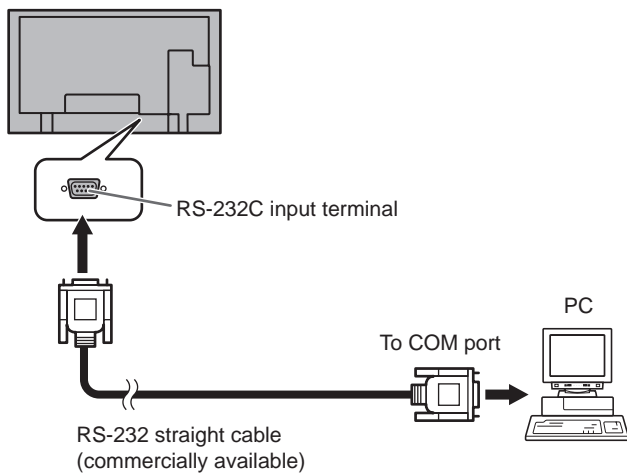

Daisy chain connection... Advanced operation

Connect with RS-232 straight cable between the PC's COM port (RS-232C connector) and the RS-232C input terminal on the first monitor.

Next, connect RS-232 straight cable to the first monitor's RS-232C output terminal and to the second monitor's RS-232C input terminal. Connect in the same way to the third and subsequent monitors.

Up to 25 monitors can be connected. (Depending on the length of the cable used and the surrounding environment.)

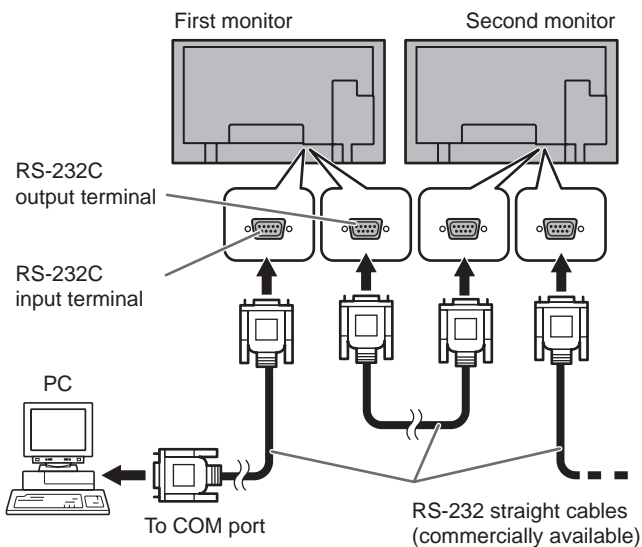

Communication conditions

Set the RS-232C communication settings on the PC to match the monitor's communication settings as follows:

Baud rate	*
Data length	8 bits
Parity bit	None

Stop bit	1 bit
Flow control	None

* Set to the same baud rate as the BAUD RATE setting of SETUP menu. (Initial setting: 9600 bps)

* When connecting multiple monitors in a daisy chain, set all monitors to the same BAUD RATE.

Communication procedure

Command format

When a command is sent from the PC to the monitor, the monitor operates according to the received command and sends a response message to the PC.

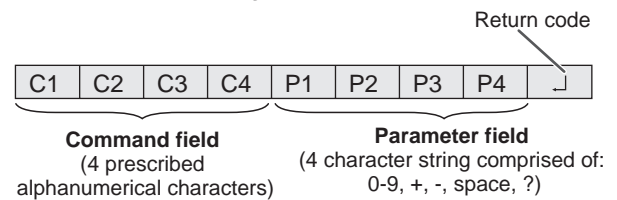

Example: VOLM0030
VOLM _ _ 30

* Be sure to input 4 characters for the parameter. Pad with spaces (" ") if necessary.

("␣" is a return code (0DH, 0AH or 0DH))

Wrong : VOLM30␣

Right : VOLM _ _ 30␣

When inputting a negative value, specify a numerical value in three digits.

Example: AUTC-009

Do not use spaces for MPOS, DATE, and SC01 through SC08. Specify parameters using a specified number of characters.

Example: MPOS010097

If a command has "R" listed for "DIRECTION" in the "RS-232C command table" on page 22, the current value can be returned by using "?" as the parameter.

Example:

VOLM ? ? ? ? ← From PC to monitor (How much is current volume setting?).

30 ← From monitor to PC (Current volume setting: 30).

* If an ID number (see page 19) has been assigned (For example, ID number = 1).

VOLM _ _ _ ? ← From PC to monitor.

30 _ 001 ← From monitor to PC.

Response code format

When a command has been executed correctly

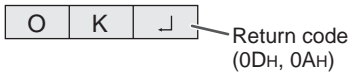

A response is returned after a command is executed.

* If an ID number has been assigned

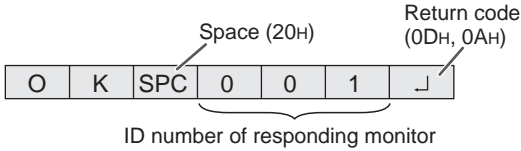

When a command has not been executed

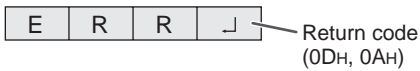

* If an ID number has been assigned

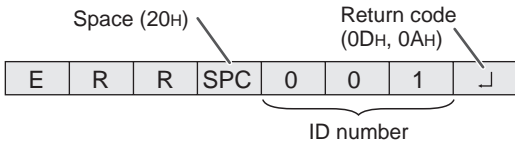

TIPS

- "ERR" is returned when there is no relevant command or when the command cannot be used in the current state of the monitor.
- If communication has not been established for reasons such as a bad connection between the PC and monitor, nothing is returned (not even ERR).
- If no monitor has been assigned the designated ID number (e.g. if the command IDSL0002 is used, but no monitor with ID number: 2 is found), no response is returned.

If execution of the command is taking some time



When the following commands are used, "WAIT" is returned. In this case, a value will be returned if you wait a while. Do not send any command during this period.

No ID number is attached to WAIT response.

- Commands which return WAIT:
 1. When repeater control is used
 2. When an IDSL or IDLK command is used
 3. When one of the following commands is used: RSET, INPS, ASNC, WIDE, EMAG, EPOS, PXSL, POWR, AGIN, MWIN, MWIP, MWPP, ESTG, EMHV, EPHV, ESHV

When control via RS-232C is locked (to prevent use) using the operation lock function (see page 17)



When RS-232C/LAN SELECT is set to LAN

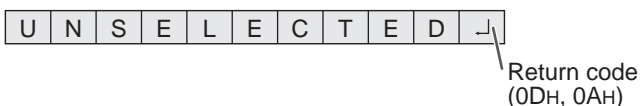

Communication interval

- After OK or ERR is returned, you must send the following commands.

To set a timeout for the command response, specify 10 seconds or longer.

When connecting multiple monitors in a daisy chain, set the timeout to at least the product of the monitor's position from the computer multiplied by 10 seconds.

Example) 3rd monitor from computer: 30 seconds or longer.

- Provide an interval of 100 ms or more between the command response and the transmission of the next command.

VOLM0020

OK

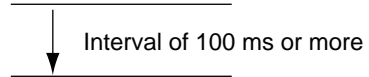

INPS0001

WAIT

OK

TIPS

- When executing ALL RESET, set the timeout period to 30 seconds or longer.
- When turning the power on while the POWER ON DELAY function is in use, set the timeout period to the POWER ON DELAY period + 10 seconds or longer.

Advanced operation

This section explains commands for daisy chain connection. The basic communication procedure is the same as in the "One-to-one connection with a PC" section.

ID numbers

You can assign a unique ID number to each monitor (see page 11). This allows you to control a particular monitor in a daisy chain of monitors.

You can assign ID numbers either from the menu screen (using the remote control) or from the PC using RS-232 cable.

[Example]

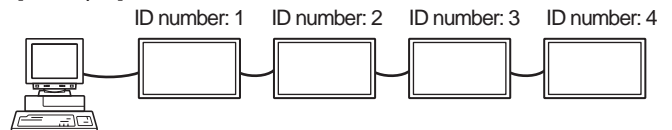

If monitors are connected as shown above, you can execute commands like "Set the volume of the monitor with ID 4 to 20".

When controlling monitors linked in a daisy chain by designating ID numbers, you should basically avoid any duplication of ID numbers.

ID numbers do not have to be assigned in ascending order starting from the PC. They can also be connected as shown below.

[Example]

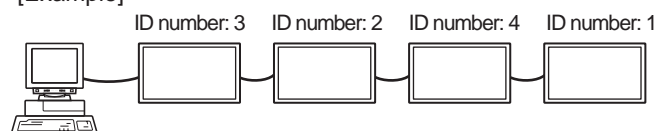

Controlling the Monitor with a PC (RS-232C)

■ Commands for ID control

The command examples shown on this page assume the following connection and ID number set up.

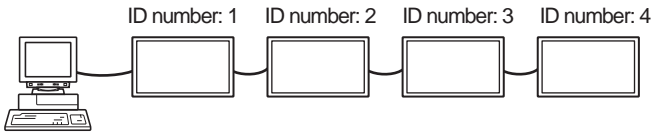

IDSTA monitor receiving this command sets its own ID number in the parameter field.

Example:

IDST0001

OK _ 001 ← The ID number of this monitor is set to 1.

TIPS

You can automatically assign ID numbers by using the IDST command with the Repeater control (see “Repeater control” on page 21).

For example, using the command “IDST001+” automatically sets the ID numbers, as shown below.

[Example]

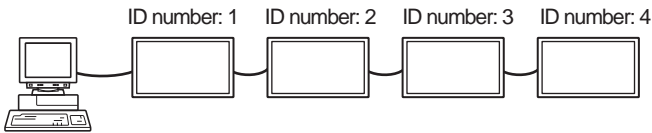

IDST001 + ← ID setting command with repeater control

WAIT

OK _ 001 ← “OK” response from ID number: 1

OK _ 002 ← “OK” response from ID number: 2

OK _ 003 ← “OK” response from ID number: 3

OK _ 004 ← “OK” response from ID number: 4 (End)

IDSLThe parameter of this command sets the ID number of the monitor. The monitor is subject to the next command.

Example:

IDSL0002 ← The next command is for the monitor with ID number: 2.

WAIT ← Searching for monitor with ID number: 2

OK _ 002 ← Found monitor with ID number: 2

VOLM0030 ← Sets volume of monitor with ID number: 2 to 30.

WAIT ← Processing

OK _ 002 ← OK response from monitor with ID number: 2

VOLM0020 ← Sets volume to 20.

OK _ 001 ← The volume of the monitor with ID number: 1 (the one directly connected to the PC) is set to 20.*

* The IDSL command is effective only once, for the immediately succeeding command.

IDLKThe parameter of this command sets the ID number of the monitor. The monitor is subject to all subsequent commands.

Example:

IDLK0002 ← Following commands are for the monitor with ID number: 2.

WAIT ← Searching for monitor with ID number: 2

OK _ 002 ← Found monitor with ID number: 2

VOLM0030 ← Sets volume of monitor with ID number: 2 to 30.*

WAIT ← Processing

OK _ 002

VOLM0020 ← Sets volume of monitor with ID number: 2 to 20.*

WAIT

OK _ 002

IDLK0000 ← Canceling fixed ID number setting

WAIT ← Canceling IDLK

OK _ 002 ← Cancellation complete

VOLM0010

OK _ 001 ← The volume of the monitor with ID number: 1 (the one directly connected to the PC) is set to 10. (IDLK is canceled.)

* The IDLK command remains effective until it is canceled, or power is shut off.

IDCK.....Provides screen display of the ID number currently assigned to a monitor, and the ID number currently set for IDLK (if any).

Example:

(After executing IDLK0002)

IDCK0000 ← (Parameter has no meaning.)

ID : 001 IDLK : 002 ← Returned response. The ID number is also displayed on the monitor screen.

IDCK000 + ← Repeater control. (If a command is used with repeater control, ID designation using IDSL or IDLK is canceled.)

WAIT

ID : 001 IDLK : 000

ID : 002 IDLK : 000

ID : 003 IDLK : 000

ID : 004 IDLK : 000

■ Repeater control

This system has a function to allow setting of multiple monitors connected in a daisy chain using a single command. This function is called repeater control. You can use Repeater control function without assigning ID numbers.

[Example]

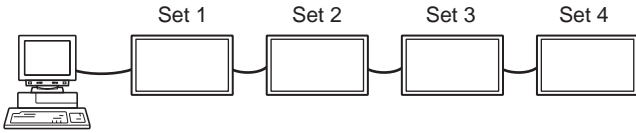

* If monitors are connected as shown above, you can execute a command like "Set all monitors' input settings to PC D-SUB".

Repeater control is achieved by setting the FOURTH CHARACTER of the parameter to "+".

Example:

VOLM030 + ← Sets volume of all monitors to 30.

In repeater control, responses are returned by all the connected monitors.

If you want to determine that a value has been returned by a specific set, assign ID numbers to each monitor in advance. When some monitors do not return their responses, the probable cause is that the monitors could not receive the command or command processing is not complete. Do not send a new command.

Example: (When 4 monitors are connected, and assigned ID numbers: 1 through 4)

VOLM030 +

WAIT

OK _ 001

OK _ 002

OK _ 003

OK _ 004

← If 4 monitors are connected in a chain, reliable operation can be ensured by sending a new command only after a reply has been returned by 4th (last) monitor.

Repeater control can also be used for reading settings.

Example:

VOLM ??? +

WAIT

10 _ 001

20 _ 002

30 _ 003

30 _ 004

Volume settings for all monitors are returned.

TIPS

- If repeater control is used during ID designation (IDSL, IDLK), the ID designation is canceled.
- When LOW POWER is selected for STANDBY MODE, repeater control cannot be performed in standby mode.

Setting of the GAMMA user data

■ To transfer the GAMMA user data

Use the user data transfer commands (UGRW, UGGW and UGBW). For each of the R, G and B colors, divide the total 512 pieces of user data into 16 blocks, and transfer 32 pieces of data with each command.

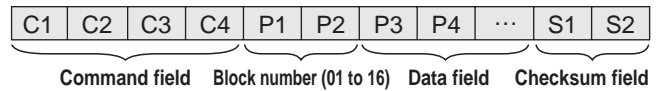

Example: To transfer the data of block 1 (0 to 31 levels) of red (R) data

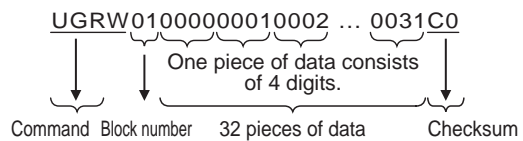

- * If data is less than 4 digits, add a "0" (zero) to make it 4 digits.
- * The checksum field is the character string (ASCII) data of lower-order one byte which indicates the sum of the block number and 32 pieces of data in hexadecimal (0 to F).

■ Saving the GAMMA user data

Use the user data save command (UGSV) to save the transferred user data in the monitor.

If the data is not saved, it will be cleared when:

- The main power switch is off
- STANDBY MODE is LOW POWER and the monitor enters standby mode

■ Activating the GAMMA user data

To activate the transferred user data, select USER for GAMMA of the PICTURE menu, or send the corresponding RS-232C command.

■ Checking the GAMMA user data

Use the user data read commands (UGRR, UGGR and UGBR) to return 512 pieces of user data for each of the R, G and B colors. Divide the data into 16 blocks and return 32 pieces of data with each command. The value to be returned is not the value stored in the monitor, but the value in the temporary memory for display. (These values are the same when the user data save command (UGSV) above has been sent.)

TIPS

- The user data is not initialized by RESET of the PICTURE menu. To initialize the user data, use ALL RESET of the FUNCTION menu.
- The GAMMA user data initialize command (UGRS) allows the initialization of the user data only.

Controlling the Monitor with a PC (RS-232C)

RS-232C command table

How to read the command table

- Command: Command field (See page 18.)
 Direction: W When the "Parameter" is set in the parameter field (see page 18), the command functions as described under "Control/Response Contents".
 R The returned value indicated under "Reply" can be obtained by setting "????", "____?" or "???" (repeater control) in the parameter field (see page 18).
 Parameter: Parameter field (See page 18.)
 Reply: Response (Returned value)
 *1: "●" indicates a command which can be used in power standby mode regardless of the STANDBY MODE setting.
 "○" indicates command which can be used in power standby mode when STANDBY MODE is set to STANDARD. (It cannot be used in the power standby mode when LOW POWER is selected.)
 "—" indicates a command which cannot be used in power standby mode.
 *2: PN-ZB01 (optional) limitations
 (A) When PN-ZB01 (optional) is not attached, (B) When PN-ZB01 (optional) is attached.
 ○ : The command can be used.
 - : Error (ERR)

Power control/Input mode selection

Function	Command	Direction	Parameter	Reply	Control/Response contents	*1	*2	
						(A)	(B)	
POWER CONTROL	POWR	W	0		Switches to standby mode.			
			1		Returns from standby mode.			
		R		0	Standby mode	●	○	○
				1	Normal mode			
				2	Input signal waiting mode			
INPUT MODE SELECTION	INPS	W	0		Toggle change for input mode. Terminals not selected in INPUT SELECT cannot be selected.		○	○
			1	PC DVI-D "ERR" when AV DVI-D is selected for DVI of INPUT SELECT.		-	○	
			2	PC D-SUB		○	○	
			3	AV COMPONENT "ERR" when PC RGB is selected for BNC of INPUT SELECT.		-	○	
			4	AV VIDEO		-	○	
			6	PC RGB "ERR" when AV COMPONENT is selected for BNC of INPUT SELECT.	●	-	○	
			7	AV DVI-D "ERR" when PC DVI-D is selected for DVI of INPUT SELECT.		-	○	
			8	AV S-VIDEO		-	○	
			9	AV HDMI		○	○	
			10	PC HDMI "ERR" when AV HDMI is selected for HDMI of INPUT SELECT.		○	○	
		R	1	PC DVI-D	●			
			2	PC D-SUB				
			3	AV COMPONENT				
			4	AV VIDEO				
			6	PC RGB				
			7	AV DVI-D				
			10	PC HDMI				

SCREEN menu

Function	Command	Direction	Parameter	Reply	Control/Response contents	*1	*2	
						(A)	(B)	
AUTO	ASNC	W	1		When the input mode is PC D-SUB, PC RGB.			
CLOCK	CLCK	WR	0-1200	0-1200	When the input mode is PC D-SUB, PC RGB. Varies depending on the signal.			
PHASE	PHSE	WR	0-63	0-63	When the input mode is PC D-SUB, PC RGB.			
POSITIONING	POSITION OF THE LONGEST DIRECTION	HPOS	WR	0-100	0-100	0-800 on PC D-SUB, PC RGB. Varies depending on the signal.		
	POSITION OF THE SHORTEST DIRECTION	VPOS	WR	0-100	0-100	0-200 on PC D-SUB, PC RGB. Varies depending on the signal.		
SIZE	POSITION OF THE LONGEST DIRECTION	HSIZ	WR	0-100	0-100		-	○
	POSITION OF THE SHORTEST DIRECTION	VSIZ	WR	0-100	0-100			○
RESOLUTION	LONGEST DIRECTION RESOLUTION	HRES	WR	300-1920	300-1920	When the input mode is PC D-SUB, PC RGB. Only even numbers are valid for parameters. Varies depending on the signal.		
	SHORTEST DIRECTION RESOLUTION	VRES	WR	200-1200	200-1200			
RESET	ARST	W	1					

Controlling the Monitor with a PC (RS-232C)

PICTURE menu

Function	Command	Direction	Parameter	Reply	Control/Response contents	*1	*2	
							(A)	(B)
AUTO	AGIN	W	1		When the input mode is PC D-SUB, PC RGB.	-		
CONTRAST	CONT	WR	0-60	0-60	0-127 on PC D-SUB, PC RGB.			
BLACK LEVEL	BLVL	WR	0-60	0-60	0-127 on PC D-SUB, PC RGB.			
TINT	TINT	WR	0-60	0-60		○		
COLORS	COLR	WR	0-60	0-60			○	
SHARPNESS	SHRP	WR	0-24	0-24				
ADVANCED (When the input mode is AV.)	FLESH TONE	FLES	WR	0-2	0-2	0: OFF, 1: LOW, 2: HIGH		
	3D-NR	TDNR	WR	0-2	0-2	0: OFF, 1: LOW, 2: HIGH	○	
	MPEG-NR	MPNR	WR	0-1	0-1	0: OFF, 1: ON		
	3D-Y/C	YCSP	WR	0-1	0-1	0: OFF, 1: ON (When the input mode is AV VIDEO)	-	
	C.M.S.-HUE	CMHR	WR	-10-10	-10-10	R		
						Y		
						G		
						C		
						B		
						M		
	CRST	W		1		Resets the hue.		
	C.M.S.-SATURATION	CMSR	WR	-10-10	-10-10	R		
						Y		
						G		
						C		
						B		
						M		
	CRST	W		2		Resets the saturation.		○
	C.M.S.-VALUE	CMVR	WR	-10-10	-10-10	R		
						Y		
G								
C								
B								
M								
CRST	W		3		Resets the brightness.			
COLOR MODE	BMOD	WR	0	0	STD			
			2	2	VIVID	○		
			3	3	sRGB (When the input mode is PC)			
WHITE BALANCE	THRU	CTMP	WR	0	0	When the input mode is PC DVI-D/PC HDMI.		
	PRESET			1-17	1-17	From 1: approximately 3,000K to 15: approximately 10,000K (500K steps) 16: approximately 5,600K, 17: approximately 9,300K	○	
	USER			99	99			
	R-CONTRAST	CRTR	WR	0-256	0-256	"ERR" when CTMP is not set to 99.		
	G-CONTRAST	CRTG	WR	0-256	0-256			
	B-CONTRAST	CRTB	WR	0-256	0-256			
COPY TO USER	CPTU	W		0	Copies a preset value to the user setting.	-		
GAMMA	GAMM	WR	0-2	0-2	0: 1.8, 1: 2.2, 2: 2.4			
			4-5	4-5	4: USER, 5: 2.0	○		
RESET	ARST	W		2		-		

AUDIO menu

Function	Command	Direction	Parameter	Reply	Control/Response contents	*1	*2	
							(A)	(B)
TREBLE	AUTR	WR	-5-5	-5-5				
BASS	AUBS	WR	-5-5	-5-5		○	○	○
BALANCE	AUBL	WR	-10-10	-10-10				
RESET	ARST	W		3		-		

Controlling the Monitor with a PC (RS-232C)

SETUP menu

Function	Command	Direction	Parameter	Reply	Control/Response contents	*1	*2		
						(A)	(B)	(B)	
OSD H-POSITION	OSDH	WR	0-100	0-100		○			
OSD V-POSITION	OSDV	WR	0-100	0-100		○			
MONITOR	STDR	WR	0-1	0-1	0: LANDSCAPE, 1: PORTRAIT	○			
MONAURAL AUDIO	MONO	WR	0-1	0-1	0: OFF, 1: ON	○			
LANGUAGE	LANG	WR	14	14	ENGLISH	○	○	○	
			1	1	DEUTSCH				
			2	2	FRANÇAIS				
			3	3	ITALIANO				
			4	4	ESPAÑOL				
			5	5	РУССКИЙ				
6	6	日本語							
POWER ON DELAY	PWOD	WR	0	0	OFF	○			
			1-60	1-60	ON				
STANDBY MODE	STBM	WR	0-1	0-1	0: STANDARD, 1: LOW POWER ("ERR" when SCHEDULE is effective or OFF is selected for LED.)	○			
HDMI SETTING	HDMI AUTO VIEW	HDAW	WR	0-1	0-1	0: OFF, 1: ON	○		
	HDMI RGB INPUT RANGE	HDRA	WR	0-2	0-2	0: AUTO, 1: FULL, 2: LIMITED			
HOT PLUG CONTROL (DVI)	HPCT	WR	0-1	0-1	0: OFF, 1: ON	○	-	○	
HOT PLUG CONTROL (HDMI)	HPCH	WR	0-1	0-1	0: OFF, 1: ON	○	○	○	
RS-232C/LAN SELECT	CTLS	WR	0-1	0-1	0 : RS-232C 1 : LAN	○	-	○	
ID NUMBER	ID NO. SETTING	IDST	W	0-255	0-255	Sets the monitor's ID number. ("0" means "no ID number".)			
						Returns the monitor's ID number.			
	ID NO. SETTING (ONCE)	IDSL	W	1-255	Sets a monitor ID number. This ID number is only effective for the command immediately after this command.				
					Clears the ID number if one has been designated.				
	ID NO. SETTING (SUBSEQUENT)	IDLK	W	1-255	Sets a monitor ID number. This ID number is effective for the next and all subsequent commands after this command.				
					Clears the ID number if one has been designated.				
ID CHECK	IDCK	W	0	ID : xxx IDLK : yyy	Displays monitor's own ID number and the selected ID number on the screen.				
BAUD RATE	BAUD	WR	0-2	0-2	0: 9600bps, 1: 19200bps, 2: 38400bps	○	○	○	
SPEAKER SELECT	SPSL	WR	0-1	0-1	0: Internal speaker, 1: External speaker	○	-	○	
OPTION DC OUT SETTING	DCOT	WR	0-2	0-2	0: OFF, 1: MODE1, 2: MODE2	-	○	○	

Controlling the Monitor with a PC (RS-232C)

OPTION menu

Function		Command	Direction	Parameter	Reply	Control/Response contents	*1	*2 (A) (B)
DATE/TIME SETTING		DATE	WR	AABBCCDDEE	AABBCCDDEE	AA: Year, BB: Month, CC: Day, DD: Time, EE: Minute	○	
SCHEDULE		SC01-SC08	WR	ABCDEFFGGH	ABCDEFFGGH	Schedule of a specified number A: Schedule 0= Not effective, 1 = Effective B: Power 0 = OFF, 1 = ON C: Day of the week 1 0 = Only once, 1 = Every week, 2 = Every day D: Day of the week 2 0 = Sunday, 1 = Monday through 6 = Saturday, 9 = Not exist E: Day of the week 3 0 = Sunday, 1 = Monday through 6 = Saturday, 9 = Not exist F: Time 00-23 G: Minute 00-59 H: Input 0 = Not specified, 1 = PC DVI-D/AV DVI-D, 2 = PC D-SUB, 3 = PC RGB/AV COMPONENT, 4 = AV VIDEO, 5 = AV S-VIDEO, 6 = PC HDMI/AV HDMI "ERR" when LOW POWER is selected for STANDBY MODE.	○	○ ○
INPUT SELECT	DVI	DVSL	WR	0-1	0-1	0: PC DVI-D, 1: AV DVI-D	○	-
	BNC	BNSL	WR	0-1	0-1	0: PC RGB, 1: AV COMPONENT	○	-
	HDMI	HDSL	WR	0-1	0-1	0: PC HDMI, 1: AV HDMI	○	○
AUDIO SELECT	PC DVI-D	ASDP	WR	1-3	1-3	1: AUDIO, 2: AUDIO 1, 3: AUDIO 2		-
	PC D-SUB	ASAP	WR	1-3	1-3	1: AUDIO		○
						2: AUDIO 1, 3: AUDIO 2		-
	PC HDMI	ASHP	WR	0-1	0-1	0: HDMI, 1: AUDIO		○
				2-3	2-3	2: AUDIO 1, 3: AUDIO 2		-
	PC RGB	ASCP	WR	1-3	1-3	1: AUDIO, 2: AUDIO 1, 3: AUDIO 2	○	-
	AV DVI-D	ASDA	WR	1-3	1-3	1: AUDIO, 2: AUDIO 1, 3: AUDIO 2		-
	AV HDMI	ASHA	WR	0-1	0-1	0: HDMI, 1: AUDIO		○
				2-3	2-3	2: AUDIO 1, 3: AUDIO 2		-
	AV COMPONENT	ASCA	WR	1-3	1-3	1: AUDIO, 2: AUDIO 1, 3: AUDIO 2		-
AV S-VIDEO	ASSA	WR	1-3	1-3	1: AUDIO, 2: AUDIO 1, 3: AUDIO 2		-	
AV VIDEO	ASVA	WR	1-3	1-3	1: AUDIO, 2: AUDIO 1, 3: AUDIO 2		-	
INPUT RESOLUTION (PC)	RESOLUTION CHECK	PXCK	R		-	Returns current resolution in the form of hhh, vvv.		-
	PIXEL SETTING (PC D-SUB, PC RGB)	PXSL	WR	1	1	768) 1360 x 768		-
				2	2	768) 1280 x 768		-
				3	3	768) 1024 x 768		-
				5	5	480) 848 x 480		-
				6	6	480) 640 x 480		-
				7	7	1050) 1680 x 1050		-
				8	8	1050) 1400 x 1050		-
				9	9	768) AUTO		○
				10	10	480) AUTO		○
INPUT RESOLUTION (AV)	RESOLUTION CHECK	RESO	R		-	480i, 480p, 1080i, 720p, 1080p, VGA, etc.		-
ZOOM2 SPECIAL SETTING (PC D-SUB, PC RGB)	Z2SP	WR	0-1	0-1	0: OFF, 1: ON	○		
SCAN MODE	SCAN	WR	0-2	0-2	0: MODE1, 1: MODE2, 2: MODE3 (When the input mode is AV)	○		
POWER MANAGEMENT (PC)	PMNG	WR	0-1	0-1	0: OFF, 1: ON	○		
POWER MANAGEMENT (AV)	PMVA	WR	0-1	0-1	0: OFF, 1: ON	○		
COLOR SYSTEM	CSYS	WR	0-5	0-5	0: AUTO, 1: PAL, 2: PAL-60, 3: SECAM, 4: NTSC3.58, 5: NTSC4.43	○	- ○	
AUDIO OUTPUT	AOUT	WR	0-1	0-1	0: VARIABLE, 1: FIXED	○		
AUDIO INPUT LEVEL	AIVP	WR	0-1	0-1	0: 1.0Vrms, 1: 0.5Vrms	○	○	
SELF ADJUST	AADJ	WR	0-1	0-1	0: OFF, 1: ON	○		
AUTO INPUT CHANGE	AINC	WR	0-1	0-1	0: OFF, 1: ON	○		

Controlling the Monitor with a PC (RS-232C)

ENLARGE menu (When the input mode is PC)

Function		Command	Direction	Parameter	Reply	Control/Response contents	*1	*2 (A) (B)
ENLARGE MODE		EMAG	WR	0-4	0-4	0: OFF, 1: 2 x 2, 2: 3 x 3, 3: 4 x 4, 4: 5 x 5	-	○ ○
		EMHV	WR	11-55	11-55	1 x 1 (OFF) to 5 x 5 ("m x n" is expressed as "mn", where m and n are the numbers of monitors specified for the longest direction and the shortest direction respectively.)		
BEZEL WIDTH	WIDTH OF THE SHORTER SIDE	BEZH	WR	0-100	0-100			
	WIDTH OF THE LONGER SIDE	BEZV	WR	0-100	0-100			
IMAGE POSITION (M x N)		EPHV	WR	11-55	11-55	Specifies values in the order of ENLARGE POSITION IN LONGEST/SHORTEST DIRECTION.		
IMAGE POSITION (2 x 2)		EPOS	WR	0-3	0-3	See the description below.		
IMAGE POSITION (3 x 3)		EPOS	WR	0-8	0-8			
IMAGE POSITION (4 x 4)		EPOS	WR	0-15	0-15			
IMAGE POSITION (5 x 5)		EPOS	WR	0-24	0-24			
ENLARGED SCREEN POSITIONING		EPSH	WR	-999-999	-999-999			
		EPSV	WR	-999-999	-999-999			
ENLARGE/IMAGE POSITION SETTING		ESTG	WR	XXYY	XXYY	XX: ENLARGE MODE (Same as EMAG), YY: IMAGE POSITION (Same as EPOS)		
		ESHV	WR	XXYY	XXYY	XX: ENLARGE MODE (Same as EMHV), YY: IMAGE POSITION (Same as EPHV)		

• IMAGE POSITION (EPOS) setting In horizontal orientation

2 x 2

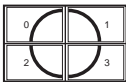

3 x 3

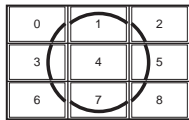

4 x 4

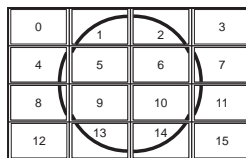

5 x 5

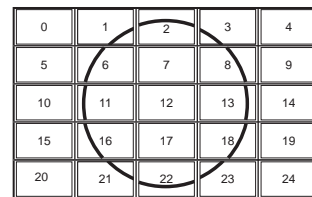

In vertical orientation

2 x 2



3 x 3



4 x 4

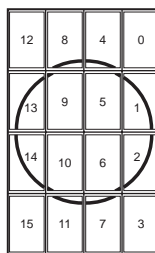

5 x 5

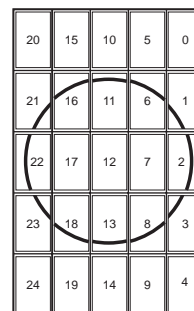

Controlling the Monitor with a PC (RS-232C)

PIP/PbyP menu

Function	Command	Direction	Parameter	Reply	Control/Response contents	*1	*2			
							(A)	(B)		
PIP MODES	MWIN	WR	0-3	0-3	0: OFF, 1: PIP, 2: PbyP, 3: PbyP2	○				
PIP SIZE	MPSZ	WR	1-12	1-12		○				
PIP POS	MHPS	W	0-100			○				
						R	0-100			
PIP POS	MVPS	W	0-100			○				
						R	0-100			
PIP POS LD+SD BATCH	MPOS	W	0-100,0-100		Specify the position in MPOSxxxxyy format. (xxx: Longer side, yyy: Shorter side position)	○				
						R	0-100,0-100	Returns a response in (xxx,yyy) format. (xxx: Longer side, yyy: Shorter side position)	○	
PIP BLEND	MWBL	WR	0-15	0-15		○				
PIP SOURCE	MWIP	WR		1	1	PC DVI-D		-	○	
				2	2	PC D-SUB		○	○	
				3	3	AV COMPONENT		-	○	
				4	4	AV VIDEO		-	○	
				6	6	PC RGB		○	-	○
				7	7	AV DVI-D		-	○	
				8	8	AV S-VIDEO		-	○	
				9	9	AV HDMI		○	○	
				10	10	PC HDMI		-	○	
				SOUND CHANGE	MWAD	WR	1-2	1-2	1: MAIN, 2: SUB	○
MAIN POS (Main screen)	MWPP	WR	0-1	0-1	0: POS1, 1: POS2	○				
PbyP2 POS (Sub screen)	MW2P	WR	0-2	0-2	0: POS1, 1: POS2, 2: POS3	○	○	○		
AUTO OFF	MOFF	WR	0-1	0-1	0: MANUAL, 1: AUTO	○				

Initialization/Functional Restriction Setting (FUNCTION) menu

Function	Command	Direction	Parameter	Reply	Control/Response contents	*1	*2	
							(A)	(B)
ALL RESET	RSET	W	0		0: ALL RESET	-	○	-
			0-1		0: ALL RESET 1, 1: ALL RESET 2	-	-	○
ADJUSTMENT LOCK	ALCK	WR	0-2	0-2	0: OFF	○		
OSD DISPLAY	LOSD	WR	0-1	0-1	0: ON, 1: OFF	○		
LED	OFLD	WR	0-1	0-1	0: ON, 1: OFF "ERR" when LOW POWER is selected for STANDBY MODE.	○	○	○
TEMPERATURE ALERT	TALT	WR	0-2	0-2	0: OFF, 1: OSD & LED, 2: LED	○		
STATUS ALERT	SALT	WR	0-2	0-2	0: OFF, 1: OSD & LED, 2: LED	○		
POWER BUTTON	PBTN	WR	0-1	0-1	0: MONITOR, 1: CONTROLLER	○		
CONTROLLER INPUT	PCIP	WR	0-2	0-2	0: D-SUB, 1: HDMI ("ERR" when MONITOR is selected for POWER BUTTON.)	○	○	○
					2: DVI-D ("ERR" when MONITOR is selected for POWER BUTTON.)	○	-	○

Controlling the Monitor with a PC (RS-232C)

Others

Function	Command	Direction	Parameter	Reply	Control/Response contents	*1	*2	
						(A)	(B)	
SCREEN SIZE (PC)	WIDE	WR	1-5	1-5	1: WIDE, 2: NORMAL, 3: Dot by Dot, 4: ZOOM1, 5: ZOOM2	○		
SCREEN SIZE (AV)	WIDE	WR	1-5	1-5	1: WIDE, 2: ZOOM1, 3: ZOOM2, 4: NORMAL, 5: Dot by Dot	○		
VOLUME	VOLM	WR	0-31	0-31		○		
MUTE	MUTE	WR	0-1	0-1	0: OFF, 1: ON	-		
INFORMATION	MODEL	INF1		Value		●		
	SERIAL NO	SRNO		Value				
BRIGHT	VLMP	WR	0-31	0-31		○		
TEMPERATURE SENSOR	DSTA	R		0	Internal temperature normal			
				1	Internal temperature abnormal (Standby mode)			
				2	Internal temperature abnormal (Temperature is normal now, but it was abnormal during operation.)	●		
				3	Internal temperature abnormal (Brightness of the backlight decreases.)			
				4	Temperature sensor abnormal		○	○
TEMPERATURE ACQUISITION	ERRT	R		Value	Temperature at temperature sensors 1 through 3 are returned in the following forms: [Sensor 1], [Sensor 2], [Sensor 3] Indicates a temperature sensor abnormality when "126" is returned.	○		
CAUSE OF LAST STANDBY MODE	STCA	W	0		Initialization			
				0	No detectable error has occurred			
				1	Standby mode by POWER button			
				2	Main power off by the main power switch			
				3	Standby mode by RS-232C or LAN	●		
				4	Waiting mode by No Signal			
				6	Standby mode by abnormal temperature			
				8	Standby mode by SCHEDULE setting			

Commands for setting of the GAMMA user data

Function	Command	Direction	Parameter	Reply	Control/Response contents	*1	*2	
						(A)	(B)	
RED GAMMA DATA TRANSFER	UGRW	W	aaxxxx ... xxxxcc (xxxx: 32 pieces) aa: 01-16 xxxx: 0000-1023 cc: 00-FF		aa: Block number xxxx: 32 pieces of user data cc: Checksum (ASCII data) of the block number and user data			
GREEN GAMMA DATA TRANSFER	UGGW	W						
BLUE GAMMA DATA TRANSFER	UGBW	W						
RED GAMMA DATA READ	UGRR	W	1-16	xxxx ... xxxx	xxxx: User data of 32 pieces	○	○	○
GREEN GAMMA DATA READ	UGGR	W	1-16	(xxxx: 32 pieces)				
BLUE GAMMA DATA READ	UGBR	W	1-16	xxxx: 0000-1023				
USER DATA INITIALIZE	UGRS	W	0		Initialize the user data.			
USER DATA SAVE	UGSV	W	0		Save the user data in the monitor.			

Controlling the Monitor with a PC (LAN)

When the PN-ZB01 (optional) is attached, your monitor can be connected to a LAN allowing you to control it from a PC on the LAN.

You can also configure the monitor to send e-mail notification when it has a problem.

The connection requires a commercially available LAN cable (UTP cable, Category 5, straight through).

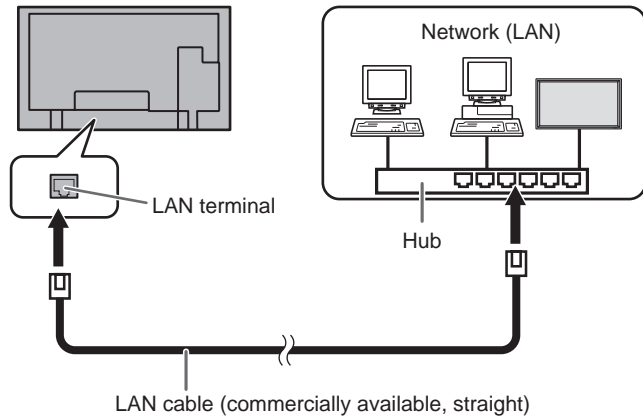

TIPS

- You must assign an IP address to the monitor by following the procedures in "Settings to connect to a LAN". (See the description on the right.)
- Your PC must be installed with Internet Explorer (version 6.0 or later).
- To control the monitor via LAN, set RS-232C/LAN SELECT to LAN. (See page 11.)
- You cannot use RS-232C and LAN control simultaneously.

Initializing personal information

- When the PN-ZB01 (optional) is attached, personal information such as e-mail addresses can be registered in the monitor. Before transferring or disposing of the monitor, initialize all settings by selecting ALL RESET 1. (See page 17.) Note that ALL RESET 2 will not initialize e-mail addresses and other settings.

Settings to connect to a LAN

Set the monitor's IP address and subnet mask to match the settings of your LAN.

These settings can be made on either the monitor or a PC connected to the monitor.

The settings depend on the configuration of your LAN. Ask your LAN administrator for details.

■ To set on the monitor

Set RS-232C/LAN SELECT on the SETUP menu to LAN, and then set the LAN SETUP options. (See page 11.)

After setting each item, select SET and press .

DHCP CLIENT

If your LAN has a DHCP server and you wish to obtain an address automatically, change this setting to ON.

To set the address manually, set this to OFF.

IP ADDRESS

If the DHCP CLIENT is set to OFF, specify an IP address.

Press or to select items, and press or to change the values.

SUBNET MASK

If the DHCP CLIENT is set to OFF, specify the subnet mask.

Press or to select items, and press or to change the values.

DEFAULT GATEWAY

If the DHCP CLIENT is set to OFF, specify the default gateway.

If you are not using a gateway, specify "0.0.0.0".

Press or to select items, and press or to change the values.

RESET

Resets the values of the LAN settings to the factory preset values.

Select ON and then press .

Controlling the Monitor with a PC (LAN)

■ To set from a PC

When the monitor is connected to a PC, LAN settings can be configured via PC.

Set up process

- (1) Connect your monitor to a PC
- (2) Specify the PC's IP address
- (3) Configure the monitor's LAN settings

(1) Connecting your monitor to a PC

Connect a commercially available crossover LAN cable (UPT cable, Category 5) to the LAN port on the PC and this monitor.

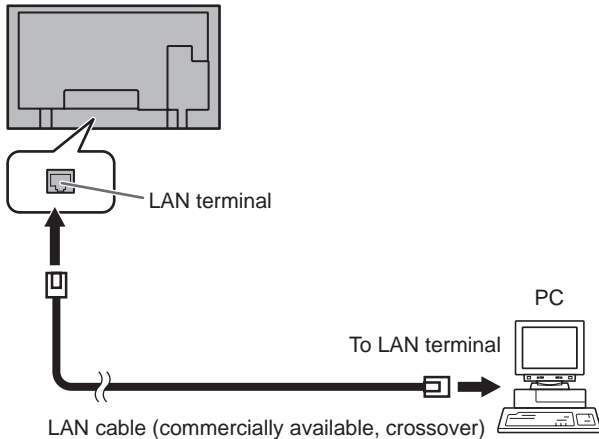

(2) Specifying the PC's IP address

To configure the monitor's LAN settings, you must temporarily change the settings on the PC.

This explanation is based on Windows XP.

1. Log on to the PC with an administrator account.
2. Click [Start], and then click "Control Panel".
3. Click "Network and Internet Connections", and then click "Network Connections".
If you are using the classic display style, double-click on "Network Connections".
4. Right click on "Local Area Connection" and from the menu, click "Properties".
5. Click "Internet Protocol (TCP/IP)", and then click "Properties".
6. Make a note of the current IP address, subnet mask, and default gateway settings.

Make sure you write this information now as you will be changing the IP address, subnet mask, and default gateway settings back to these settings afterwards.

7. Temporarily change the IP address and subnet mask.
To access the monitor as it is shipped from the factory, set as follows.

- IP Address: 192.168.150.3
- Subnet Mask: 255.255.255.0
- Default Gateway: (leave blank)

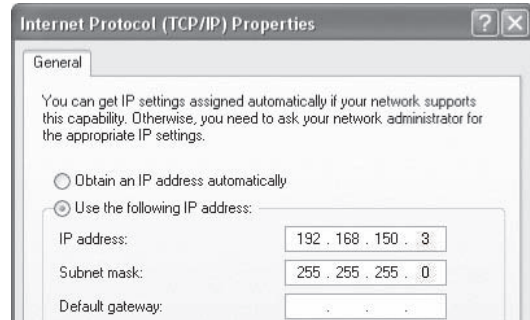

8. Click [OK] and then reboot the PC.

TIPS

- This monitor is factory preset as shown below.
IP Address : 192.168.150.2
Subnet Mask : 255.255.255.0
Default Gateway : 0.0.0.0

(3) Configuring the monitor's LAN settings

Access the monitor using Internet Explorer.

Controlling the monitor

1. Turn the power ON to the monitor.
2. Set RS-232C/LAN SELECT on the SETUP menu to LAN.

PC operation

3. Launch Internet Explorer, in the "Address" box type "http://192.168.150.2/" and press the Enter key.



- You will be prompted to enter a user name and password.
4. Leave the user name and password boxes blank and click [OK].

5. Click on “LAN SETUP” under NETWORK.



6. Specify the “DHCP CLIENT”, “IP ADDRESS”, etc.

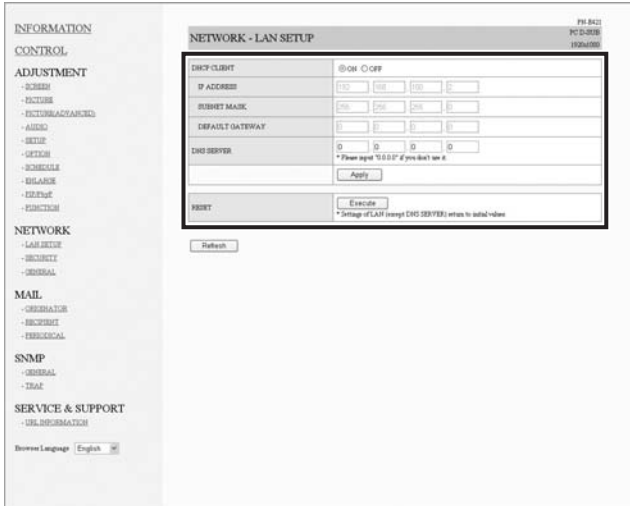

DHCP CLIENT

If your LAN has a DHCP server and you wish to obtain an address automatically, change this setting to “ON”. To set the address manually, set this to “OFF”.

IP ADDRESS

If the DHCP CLIENT is set to “OFF”, specify an IP address.

SUBNET MASK

If the DHCP CLIENT is set to “OFF”, specify the subnet mask.

DEFAULT GATEWAY

If the DHCP CLIENT is set to “OFF”, specify the default gateway. If you are not using a default gateway, specify “0.0.0.0”.

- When the setting is changed, click [Apply].
- Check the message and click [OK].
- Exit Internet Explorer.
- Restore the PC’s IP address jotted in Step 6, “(2) Specifying the PC’s IP address”.
- Connect the monitor and the PC to the LAN.

! Caution

- Wait 10 seconds after clicking [OK] before proceeding.
- When operating using the remote control unit or similar, click [Refresh].

Controlling with a PC

■ Basic operation

You use Internet Explorer on a PC on the LAN to control the monitor.

- Launch Internet Explorer on the PC.
- In the “Address” box, type “http://” followed by your monitor’s IP address followed by “/”, then press the Enter key.



When prompted to enter a user name and password, type the user name and password that you specified in the security settings (see page 33), and click [OK].

If you did not make any security settings, leave the spaces blank and click on [OK].

- You can check, control, and change the monitor’s status and settings by clicking the menu items on the left side of the screen.



- If you see an [Apply] button next to a setting, click it after you change that setting.

TIPS

- See pages 32 to 36 for details on each setting.
- If you click [Refresh] before the screen finishes updating the current display, the “Server Busy Error” will appear. Wait for a moment before operating your monitor again.
- You cannot operate the monitor while it is warming up.
- If “DHCP CLIENT” is set to “ON”, press  on the remote control unit two times and then check the monitor’s IP address.

Controlling the Monitor with a PC (LAN)

■ INFORMATION

Information about this monitor appears.



■ CONTROL

You can control the operations corresponding to the buttons **POWER INPUT SIZE** (○ ○ ○) on the remote control unit. (See page 5.)

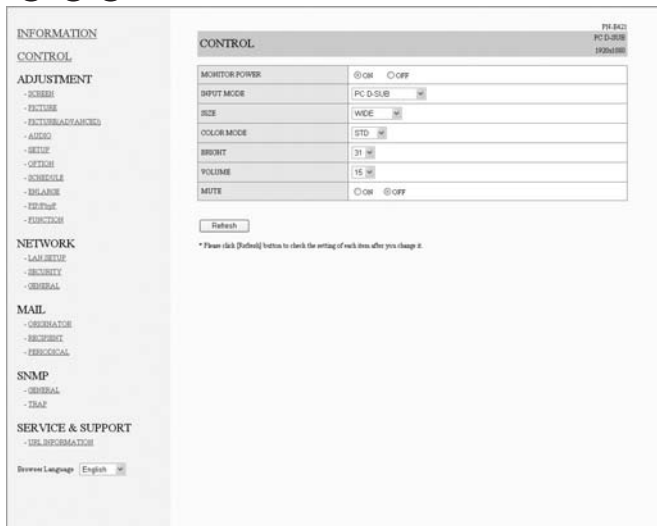

■ ADJUSTMENT

You can adjust these settings which are also available on the monitor's menu.

- SCREEN (See page 10.)
- PICTURE (See Page 10.)
- PICTURE (ADVANCED) (See Page 16.)
- AUDIO (See page 11.)
- SETUP (See page 11.)
- OPTION (See page 12.)
- SCHEDULE (See page 15.)
- ENLARGE (See page 12.)
- PIP/PbyP (See page 13.)
- FUNCTION (See page 17.)

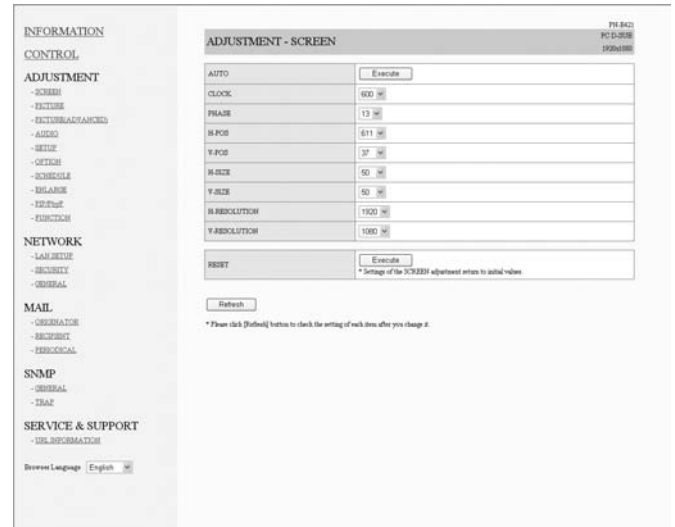

TIPS

- In standby mode, Power ON is the operation available.
- MONITOR POWER turns the monitor power ON/OFF regardless of the POWER BUTTON setting in the FUNCTION menu.

■ NETWORK (LAN SETUP)

This screen allows you to set the settings necessary when the monitor is connected to a LAN.

DHCP CLIENT

If your LAN has a DHCP server and you wish to obtain an address automatically, change this setting to “ON”. To set the address manually, set this to “OFF”.

IP ADDRESS

If the DHCP CLIENT is set to “OFF”, specify an IP address.

SUBNET MASK

If the DHCP CLIENT is set to “OFF”, specify the subnet mask.

DEFAULT GATEWAY

If the DHCP CLIENT is set to “OFF”, specify the default gateway. If you are not using a default gateway, specify “0.0.0.0”.

DNS SERVER

Specify the DNS server address. If you are not using a DNS server, specify “0.0.0.0”.

RESET

Clicking [Execute] returns all of the LAN SETUP settings to the factory-preset values except for the DNS SERVER setting.

■ NETWORK (SECURITY)

This screen allows you to specify the security-related settings.

USER NAME / PASSWORD

Sets up a user name and password to restrict access to this monitor. After entering a user name and password, click [Apply].

ACCEPT IP ADDRESS

You can limit access to this monitor by registering IP addresses of PCs that should have access. To limit access, specify the option “From only specific IP addresses”. Otherwise, to allow access from any PC, specify “All IP Addresses”.

IP ADDRESS 1 to 3

If “ACCEPT IP ADDRESS” is set to “From only specific IP addresses”, enter the IP addresses that you want to allow.

TIPS

- The USER NAME and PASSWORD can be up to 8 alphanumeric characters or symbols.
- To cancel the user name and/or password after it has been set, make the box empty and click [Apply].

Controlling the Monitor with a PC (LAN)

■ NETWORK (GENERAL)

This screen allows you to specify the general LAN settings.

MONITOR NAME

Specify a name for this monitor as it should appear on the Internet Explorer screen.

AUTO LOGOUT TIME

Specify the time (in minutes) to elapse before automatically disconnecting this monitor from the network. Specify in minutes from 1 to 65535. A value of '0' will disable this function.

DATA PORT

Specify the TCP port number to use for exchanging data with the monitor. Specify a value from 1025 to 65535.

SEARCH PORT

Specify the port number to use when searching for this monitor. Specify a value from 1025 to 65535.

INSTALLATION INFORMATION (NAME/LOCATION)

Specify the information to display for this monitor in the Internet Explorer window.

TIPS

- The MONITOR NAME can be up to 16 alphanumeric characters or symbols.
- Enter up to 50 characters in the NAME field in the INSTALLATION INFORMATION.
- Enter up to 100 characters in the LOCATION field in the INSTALLATION INFORMATION.

■ MAIL (ORIGINATOR)

This screen allows you to configure the e-mail sent periodically or when the monitor has an error. The settings depend on the configuration of your LAN. Ask your LAN administrator for details.

SMTP SERVER

Specify the SMTP server address for sending e-mail.
* When using a domain name, make sure to specify the DNS server as well. (See page 33.)

ORIGINATOR E-MAIL ADDRESS

Specify the e-mail address for this monitor. This address becomes the e-mail address of the originator.

ORIGINATOR NAME

Specify the name for the originator. This name appears in the "Originator Name" field of the e-mail.

AUTHENTICATION

Specify the authentication method to use when sending e-mail.

POP SERVER

If the "AUTHENTICATION" method is "POP before SMTP", specify the POP server address.

ACCOUNT NAME / PASSWORD

If the "AUTHENTICATION" method is "POP before SMTP", specify the account name and password to connect to the POP server.

TIPS

- You can enter up to 64 alphanumeric characters or symbols for the ORIGINATOR E-MAIL ADDRESS, ORIGINATOR NAME, ACCOUNT NAME, and PASSWORD.
- The SMTP SERVER and POP SERVER can be up to 64 characters.
The following characters can be used: a-z, A-Z, 0-9, - , .

MAIL (RECIPIENT)

This screen allows you to specify the recipients of the e-mail sent periodically or when the monitor has an error.

No.	RECIPIENT E-MAIL ADDRESSES * MAX 64 characters	CONDITION			CONFIRMATION
		PERIODICAL	TEMPERATURE	HARDWARE	
1	<input type="text"/>	<input type="checkbox"/>	<input type="checkbox"/>	<input type="checkbox"/>	<input type="button" value="Test"/>
2	<input type="text"/>	<input type="checkbox"/>	<input type="checkbox"/>	<input type="checkbox"/>	<input type="button" value="Test"/>
3	<input type="text"/>	<input type="checkbox"/>	<input type="checkbox"/>	<input type="checkbox"/>	<input type="button" value="Test"/>

Attach the log file to a TEMPERATURE/HARDWARE error e-mail
 * attach no log file to a PERIODICAL report e-mail

MAIL (PERIODICAL)

When PERIODICAL for CONDITION of MAIL (RECIPIENT) is checked, set the date and time to send the mail.

DAY OF THE WEEK: SUN MON TUE WED THU FRI SAT
 * Please check the day of the week sending e-mail.

TIME: 1: --:--:--
 2: --:--:--
 3: --:--:--
 4: --:--:--
 * Time sending an e-mail.

RECIPIENT E-MAIL ADDRESSES

Specify the e-mail addresses to send error notification e-mail to.

CONDITION

Specify the conditions to send mails. When you check PERIODICAL, specify the date and time to send the mails in the PERIODICAL setting.

CONFIRMATION

Sends test e-mail. This allows you to confirm that the e-mail settings are configured properly.

Attach the log file to a TEMPERATURE/HARDWARE error e-mail

When this option is checked, a log is added to the mail which notifies a temperature or status error.

TIPS

- The RECIPIENT E-MAIL ADDRESSES can be up to 64 alphanumeric characters or symbols.

DAY OF THE WEEK

Specify the day of the week to send the periodical mails.

TIME

Specify the time of the day to send the periodical mails.

Caution

- Do not turn off the main power when you set to send the periodical mails.
- Specify the correct date and time. (See page 12.) If the date and time settings are incorrect, the periodical mail is not sent properly.
- Regularly confirm that the specified date and time is correct.
- When LOW POWER is selected for STANDBY MODE, periodical mails will not be sent in standby mode.

Controlling the Monitor with a PC (LAN)

■ SNMP

You can configure settings related to SNMP.

SNMP SETTING

Set whether to enable or disable SNMP.

VERSION

Set the version of the SNMP to be supported.

COMMUNITY NAME 1 to 3

Set the name of the community required for the access.

USER 1 to 3

Set the user name, password, authentication method and other options required for access.

TRAP SETTING

Set whether to enable or disable the trap function. When this function is enabled, a trap will be sent when the monitor is turned on.

TRAP WHEN AUTHENTICATION FAILS

Set whether the trap function sends a notification when authentication fails.

TRAP ADDRESS & PORT NO.

Set the destination address and port number of the notification sent by the trap function.

! Caution

- After you set SNMP, click [Switch the main power of monitor off and on now.] or turn off the monitor and then turn it on again with the main power switch. When the monitor restarts, wait about 30 seconds and then start the next operation.

TIPS

- Depending on the SNMP settings, a short delay may occur before the SNMP is usable. (About 2 minutes)
- Up to 16 alphanumeric letters and symbols can be used for the community name, user name and password.

■ SERVICE & SUPPORT (URL INFORMATION)

You can display a specific URL in the URL INFORMATION field on the INFORMATION screen when an error occurs in the monitor. (See page 32.)

URL INFORMATION

Enter the URL to display on the INFORMATION screen when an error occurs on the monitor.

Up to 64 alphanumeric characters or symbols can be used.

CONDITION

Specify the condition to display the URL.

CONFIRMATION

The home page of the specified URL is displayed.

You can check whether the URL you entered is correct.

TIPS

- It is also possible to specify the message text, such as the name of a contact or a telephone number, to be displayed instead of the linked URL.

Troubleshooting

If you are experiencing any problem with your display, before calling for service, please review the following troubleshooting tips.

There is no picture or sound.

- Is the power cord disconnected?
- Is the main power switch off?
- Is the monitor in standby mode (the power LED illuminating in orange)?
- Make sure correct input mode is selected. (See page 5.)
- If any external equipment is connected, make sure the equipment is operating (playing back).

Remote control does not work.

- Are the batteries inserted with polarity (+,-) aligned? (See Operation manual.)
- Are the batteries exhausted?
- Point the remote control unit toward the monitor's remote control sensor.
- Is the menu display hidden or is operation disabled? (See page 17.)

Sound from left and right speakers is reversed.

Sound is heard from only one side.

- Are audio cables connected properly?
- Make sure audio cables for external speakers are connected properly: left and right cables may be reversed or one of the two cables may not be connected.
- Check the setting of BALANCE for AUDIO menu. (See page 11.)

There is a picture but no sound.

- Is the sound muted?
- Make sure the volume is not set to minimum.
- Are audio cables connected properly?
- Is the setting of AUDIO SELECT on the OPTION menu correct? (See page 12.)
- Is the setting of SPEAKER SELECT on the SETUP menu correct?

Unstable video.

- The signal may be incompatible.
- Try the automatic screen adjustment when the PC D-sub input terminal or PC RGB input terminals are used.

The video from the PC/AV HDMI input terminal does not appear properly.

- Is the setting for HDMI of INPUT SELECT on the OPTION menu correct? (See page 12.)
- Is the HDMI cable HDMI standard compliant? The monitor will not work with cables that are not standard compliant.
- Is the input signal compatible with this monitor? (See page 41.)

The video from the PC/AV DVI-D input terminal does not appear properly.

- Is the setting for DVI of INPUT SELECT on the OPTION menu correct? (See page 12.)
- Is the input signal compatible with this monitor? (See page 41.)
- Turn off the power to the connected equipment and then turn the power on again.
- If the monitors are connected in a daisy chain, turn off the power to all the monitors connected in a daisy chain and then turn the power on again.

The video from the PC RGB input terminals or AV component input terminals does not appear properly.

- Is the setting for BNC of INPUT SELECT on the OPTION menu correct? (See page 12.)
- Is the input signal compatible with this monitor? (See page 41.)

Control buttons do not work.

There is no picture.

- Load noises from outside may be interfering with normal operation. Turn off the power and turn it on after waiting at least 5 seconds, and then check the operation.

The input mode changes automatically.

- When the AUTO INPUT CHANGE is ON and no signal is present in a selected input mode, the AUTO INPUT CHANGE automatically changes the selected mode to a mode where a video signal is present.
The input mode may change in the following cases:
 - When a computer is in standby mode.
 - When video play is stopped with a playback device.

Power LED flashes red.

“STATUS [xxxx]” appears in the corner of the screen.

- Hardware has a problem. Turn off the monitor and request repair from your SHARP dealer.
(When STATUS ALERT is set to OSD & LED. This varies depending on the setting.)

When “AUTO DIMMING” is displayed.

- When the internal temperature of the monitor rises excessively, the brightness of the backlight automatically decreases in order to prevent a further temperature rise. If you attempt to use  to adjust the brightness while the monitor is in this state, “AUTO DIMMING” is displayed and you cannot change the brightness.
- Remove the cause of the excessive temperature rise.

The monitor makes a cracking sound.

- You may occasionally hear a cracking sound from the monitor. This happens when the cabinet slightly expands and contracts according to change in temperature. This does not affect the monitor's performance.

The Power LED is flashing in red and green alternately.

When “TEMPERATURE” is displayed in the corner of the screen.

- When the internal temperature of the monitor rises excessively, the brightness of the backlight decreases automatically in order to prevent high-temperature-related problems. When this occurs, “TEMPERATURE” is displayed on the screen and the Power LED flashes red and green alternately. (When TEMPERATURE ALERT is set to OSD & LED. This varies depending on the setting.)
- If the internal temperature rises further, the monitor automatically enters standby mode. (The Power LED continues flashing red and green alternately.)
- Remove the cause of the excessive temperature rise.
 - If the monitor enters standby mode due to a rise in temperature, to return to normal display, turn the power switch off and then back on again. The monitor, however, will enter standby mode again if the cause of the temperature rise is not eliminated.
 - Check whether the monitor is placed at a location where a quick rise in temperature is likely. Internal temperature rises quickly if the vents on the monitor are blocked.
 - Internal temperature rises quickly if dust accumulates inside the monitor or around the vents. Remove dust if possible. Ask Sharp dealer about removing internal dust.

Specifications

■Product Specifications

Model	PN-E471R		PN-E421		
LCD component	47" Class [46-15/16 inch (119.3cm) diagonal] TFT LCD		42" Class [42-1/16 inch (106.7cm) diagonal] TFT LCD		
Max. resolution (pixels)	1920 x 1080				
Max. colors	Approx. 1.06 billion colors				
Pixel pitch	0.542 mm (H) x 0.542 mm (V)		0.485 mm (H) x 0.485 mm (V)		
Viewing angle	178° right/left/up/down (contrast ratio ≥ 10)				
Screen active area inch (mm)	40-15/16 x 23 (1039.7 x 584.8)		36-5/8 x 20-5/8 (930.2 x 523.3)		
Computer input signal	Digital (DVI 1.0 standard-compliant), Analog RGB (0.7 Vp-p) [75 Ω]				
Sync signal	Horizontal/vertical separate (TTL: positive/negative), Sync-on-green, Composite sync (TTL: positive/negative)				
Video color system	NTSC (3.58MHz)/NTSC (4.43MHz)/PAL/PAL-60/SECAM				
Plug and play	VESA DDC2B				
Power management	VESA DPMS, DVI DMPM				
Input terminals	PC/AV	Digital	HDMI x 1		
	PC	Analog	Mini D-sub 15 pin, 3 rows x 1		
	Audio		3.5 mm mini stereo jack x 1		
	Serial (RS-232C)		D-sub 9 pin x 1		
	When PN-ZB01 (optional) is attached	PC/AV	Digital	DVI-D 24 pin (HDCP compatible) x 1	
		PC	Analog	BNC *1*2 x 1	
		AV	Composite video	BNC x 1	
			S-video	x 1	
		Component	BNC (Y, Cb/Pb, Cr/Pr) *1 x 1		
	Audio		RCA pin (L/R) x 2		
Output terminals	Audio		RCA pin (L/R) x 1		
	Serial (RS-232C)		D-sub 9 pin x 1		
	When PN-ZB01 (optional) is attached	PC/AV	Digital	DVI-D 24 pin x 1	
		External speaker		10 W + 10 W [6 Ω]	
LAN terminal [When PN-ZB01 (optional) is attached]	10 BASE-T/100 BASE-TX				
Speaker output	10 W + 10 W				
Power requirement	AC 100 V - 240 V, 50/60 Hz				
Operating temperature *5	32°F to 104°F (0°C to 40°C)				
Operating humidity	20% to 80% (no condensation)				
Power consumption	Factory Setting (Audio input: enabled / disabled)		245 W / 250 W	195 W / 200 W	
	Maximum (Audio input: enabled / disabled)		255 W / 260 W	220 W / 225 W	
	Input signal waiting mode *3 / Standby mode *4		2 W / 2 W	2 W / 2 W	
	When PN-ZB01 (optional) is attached	Factory Setting (Audio input: enabled / disabled)		250 W / 255 W	200 W / 205 W
		Maximum (Audio input: enabled / disabled)		260 W / 265 W	225 W / 230 W
		Input signal waiting mode *3 / Standby mode *4		4.8 W / 4.5 W	5 W / 4.5 W
Dimensions (excluding protrusions) inch (mm)	Approx. 42-5/8 (W) x 4-3/8 (D) x 24-3/4 (H) (1,083 x 111 x 628)		Approx. 38-5/16 (W) x 4-15/16 (D) x 22-5/16 (H) (973 x 126 x 566)		
Weight lbs. (kg)	Approx. 56.2 (25.5) [When PN-ZB01 (optional) is attached: Approx. 57.3 (26)]		Approx. 48.5 (22) [When PN-ZB01 (optional) is attached: Approx. 49.6 (22.5)]		

*1 Cannot be used simultaneously.

*2 Does not support plug and play.

*3 When AUTO INPUT CHANGE is set to OFF.

*4 When STANDBY MODE is set to STANDARD. When STANDBY MODE is set to LOW POWER, PN-E471R: 0.8 W, PN-E421: 0.8 W.

*5 Temperature condition may change when using the display together with the optional equipments recommended by SHARP.

In such cases, please check the temperature condition specified by the optional equipments.

As a part of our policy of continuous improvement, SHARP reserves the right to make design and specification changes for product improvement without prior notice. The performance specification figures indicated are nominal values of production units. There may be some deviations from these values in individual units.

■ Dimensional Drawings

Note that the values shown are approximate values.

[PN-E471R]

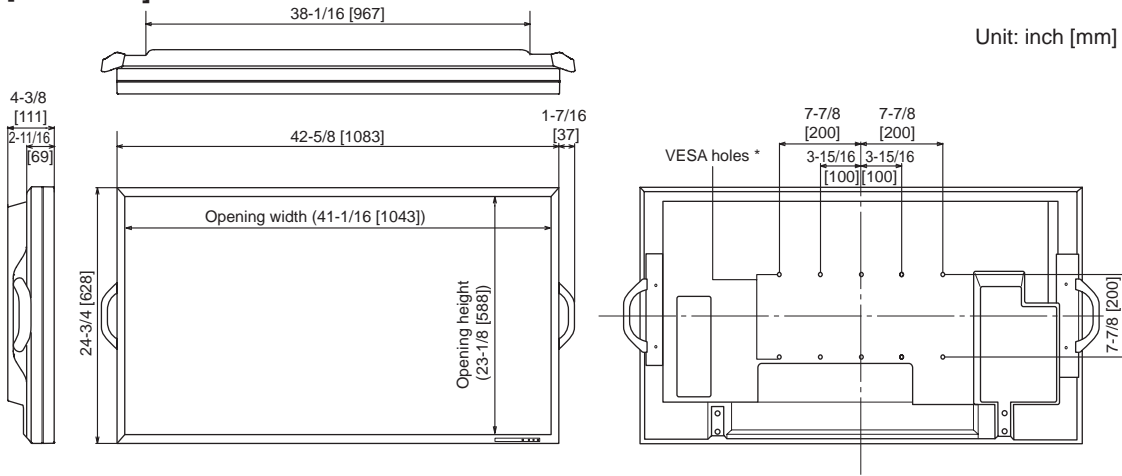

When mounting the monitor, be sure to use a wall-mount bracket that complies with the VESA-compatible mounting method. SHARP recommends using M6 screws and tighten the screws. Note that screw hole depth of the monitor is 3/8 inch (10 mm). Loose mounting may cause the product to fall, resulting in serious personal injuries as well as damage to the product. The screw and hole should come together with over 5/16 inch (8 mm) length of thread. Use a bracket which has been approved for UL1678 standard, and which can endure at least 4 times or more the weight of the monitor.

[PN-E421]

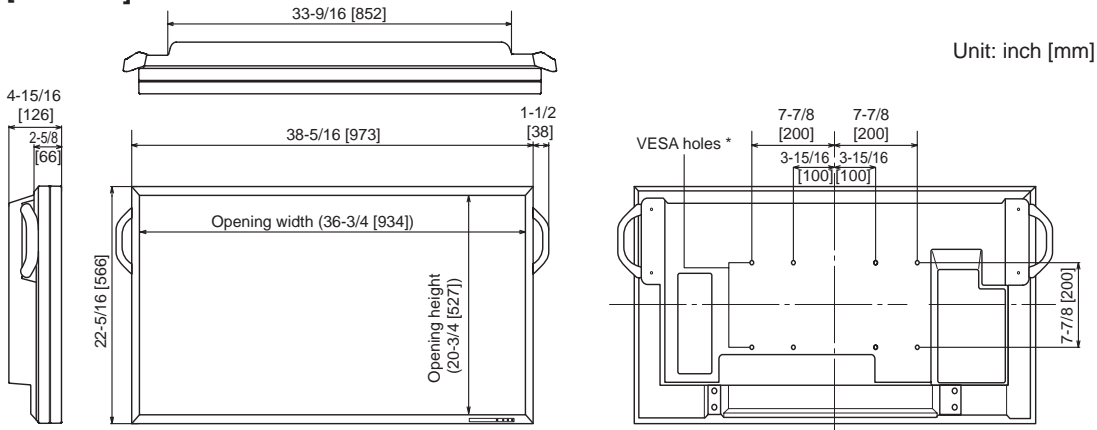

When mounting the monitor, be sure to use a wall-mount bracket that complies with the VESA-compatible mounting method. SHARP recommends using M6 screws and tighten the screws. Note that screw hole depth of the monitor is 3/8 inch (10 mm). Loose mounting may cause the product to fall, resulting in serious personal injuries as well as damage to the product. The screw and hole should come together with over 5/16 inch (8 mm) length of thread. Use a bracket which has been approved for UL1678 standard, and which can endure at least 4 times or more the weight of the monitor.

Specifications

■Power management

This monitor conforms to VESA DPMS and DVI DMPM. Both your video card and computer must support the same standard in order for the monitor's power management function to work.

DPMS: Display Power Management Signaling

DPMS	Screen	Power consumption*1	Hsync	Vsync
ON STATE	Display	260 W*2 225 W*2	Yes	Yes
STANDBY	No display	2 W*2*3 2 W*2*3	No	Yes
SUSPEND			Yes	No
OFF STATE			No	No

DMPM: Digital Monitor Power Management

DMPM	Screen	Power consumption*1
Monitor ON	Display	260 W*2 225 W*2
Active OFF	No display	2 W*2*3 2 W*2*3

*1 Upper value: PN-E471R, Lower value: PN-E421.

*2 When PN-ZB01 (optional) is not connected.

*3 When AUTO INPUT CHANGE is set to OFF.

■DDC (plug and play)

The monitor supports the VESA DDC (Display Data Channel) standard.

DDC is a signal standard for plug and play between monitors and computers. Information about resolution and other parameters is exchanged between the two. This function can be used if the computer supports DDC and it has been configured to detect plug-and-play monitors.

There are several types of DDC, depending on the communication method used. This monitor supports DDC2B.

■Compatible signal timing (PC)

Screen resolution		Hsync	Vsync	Dot frequency	Digital		Analog (D-SUB/RGB*2)
					DVI*2	HDMI	
VESA	640 × 480	31.5kHz	60Hz	25.175MHz	Yes	Yes	Yes
		37.9kHz	72Hz	31.5MHz	Yes	Yes	Yes
		37.5kHz	75Hz	31.5MHz	Yes	Yes	Yes
	800 × 600	35.1kHz	56Hz	36.0MHz	-	-	Yes
		37.9kHz	60Hz	40.0MHz	Yes	Yes	Yes
		48.1kHz	72Hz	50.0MHz	Yes	Yes	Yes
		46.9kHz	75Hz	49.5MHz	Yes	Yes	Yes
	848 × 480	31.0kHz	60Hz	33.75MHz	Yes	-	Yes
	1024 × 768	48.4kHz	60Hz	65.0MHz	Yes	Yes	Yes
		56.5kHz	70Hz	75.0MHz	Yes	Yes	Yes
		60.0kHz	75Hz	78.75MHz	Yes	Yes	Yes
	1152 × 864	67.5kHz	75Hz	108.0MHz	Yes	Yes	Yes
	1280 × 768	47.8kHz	60Hz	79.5MHz	Yes	-	Yes
		60.3kHz	75Hz	102.25MHz	Yes	-	Yes
	1280 × 800	49.7kHz	60Hz	83.5MHz	Yes	Yes	Yes
	1280 × 960	60.0kHz	60Hz	108.0MHz	Yes	Yes	Yes
	1280 × 1024	64.0kHz	60Hz	108.0MHz	Yes	Yes	Yes
		80.0kHz	75Hz	135.0MHz	Yes	Yes	Yes
	1360 × 768	47.7kHz	60Hz	85.5MHz	Yes	Yes	Yes
1400 × 1050	65.3kHz	60Hz	121.75MHz	Yes	Yes	Yes	
1440 × 900	55.9kHz	60Hz	106.5MHz	Yes	-	Yes	
1600 × 1200*1	75.0kHz	60Hz	162.0MHz	Yes	Yes	Yes	
1680 × 1050	65.3kHz	60Hz	146.25MHz	Yes	Yes	Yes	
1920 × 1200*1	74.0kHz	60Hz	154.0MHz	Yes	Yes	Yes	
Wide	1280 × 720	44.7kHz	60Hz	74.4MHz	Yes	Yes	Yes
		66.3kHz	60Hz	148.5MHz	Yes	Yes	Yes
	1920 × 1080	67.5kHz	60Hz	148.5MHz	Yes	Yes	Yes
US TEXT	720 × 400	31.5kHz	70Hz	28.3MHz	Yes	Yes	Yes
Sun	1024 × 768	48.3kHz	60Hz	64.13MHz	-	-	Yes
		53.6kHz	66Hz	70.4MHz	-	-	Yes
		56.6kHz	70Hz	74.25MHz	-	-	Yes
	1152 × 900	61.8kHz	66Hz	94.88MHz	-	-	Yes
		71.8kHz	76.2Hz	108.23MHz	-	-	Yes
	1280 × 1024	71.7kHz	67.2Hz	117.01MHz	-	-	Yes
		81.1kHz	76Hz	134.99MHz	-	-	Yes
1600 × 1000	68.6kHz	66Hz	135.76MHz	-	-	Yes	

*1 Displays a reduced image. *2 Available when the PN-ZB01 (optional) is attached.

- * All are compliant only with non-interlaced.
- * Depending on the connected PC, images may not be displayed properly even if the compatible signal described above is input.
- * The frequency values for the Sun are reference values.

■Compatible signal timing (AV)

Screen resolution	Frequency	DVI-D*	HDMI	Component*
1920 × 1080p	24Hz	-	Yes	-
	50Hz	Yes	Yes	Yes
	59.94Hz	Yes	Yes	Yes
	60Hz	Yes	Yes	Yes
1920 × 1080i	50Hz	Yes	Yes	Yes
	59.94Hz	Yes	Yes	Yes
	60Hz	Yes	Yes	Yes
1280 × 720p	50Hz	Yes	Yes	Yes
	59.94Hz	Yes	Yes	Yes
	60Hz	Yes	Yes	Yes
720 × 576p	50Hz	Yes	Yes	Yes
720 × 480p	59.94Hz	Yes	Yes	Yes
	60Hz	Yes	Yes	Yes
640 × 480p(VGA)	59.94Hz	Yes	Yes	-
	60Hz	Yes	Yes	-
720(1440) × 576i	50Hz	-	Yes	Yes
720(1440) × 480i	59.94Hz	-	Yes	Yes
	60Hz	-	Yes	Yes

* Available when the PN-ZB01 (optional) is attached.

Specifications

■PC/AV DVI-D input terminal pins

(DVI-D 24 pin)

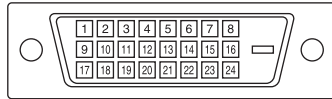

No.	Function	No.	Function
1	TMDS data 2-	13	N.C.
2	TMDS data 2+	14	+5V
3	TMDS data 2/4 shield	15	GND
4	N.C.	16	Hot-plug detection
5	N.C.	17	TMDS data 0-
6	DDC clock	18	TMDS data 0+
7	DDC data	19	TMDS data 0/5 shield
8	N.C.	20	N.C.
9	TMDS data 1-	21	N.C.
10	TMDS data 1+	22	TMDS clock shield
11	TMDS data 1/3 shield	23	TMDS clock+
12	N.C.	24	TMDS clock-

■PC/AV HDMI input terminal pins

(HDMI™ Connector)



No.	Function	No.	Function
1	TMDS data 2+	11	TMDS clock shield
2	TMDS data 2 shield	12	TMDS clock-
3	TMDS data 2-	13	CEC
4	TMDS data 1+	14	N.C.
5	TMDS data 1 shield	15	SCL
6	TMDS data 1-	16	SDA
7	TMDS data 0+	17	DDC/CEC GND
8	TMDS data 0 shield	18	+5V
9	TMDS data 0-	19	Hot-plug detection
10	TMDS clock+		

■PC D-sub input terminal pins

(Mini D-sub 15 pin)

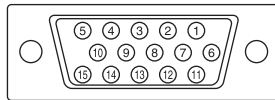

No.	Function	No.	Function
1	Red video signal input	9	+5V
2	Green video signal input	10	GND
3	Blue video signal input	11	N.C.
4	N.C.	12	DDC data
5	GND	13	Hsync signal input
6	GND for red video signal	14	Vsync signal input
7	GND for green video signal	15	DDC clock
8	GND for blue video signal		

■RS-232C input terminal pins

(D-sub 9 pin)

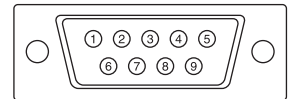

No.	Function	No.	Function
1	N.C.	6	N.C.
2	Transmitted data	7	N.C.
3	Received data	8	N.C.
4	N.C.	9	N.C.
5	GND		

■PC/AV DVI-D output terminal pins

(DVI-D 24 pin)

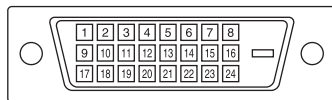

No.	Function	No.	Function
1	TMDS data 2-	13	N.C.
2	TMDS data 2+	14	+5V
3	TMDS data 2/4 shield	15	GND
4	N.C.	16	Hot-plug detection
5	N.C.	17	TMDS data 0-
6	DDC clock	18	TMDS data 0+
7	DDC data	19	TMDS data 0/5 shield
8	N.C.	20	N.C.
9	TMDS data 1-	21	N.C.
10	TMDS data 1+	22	TMDS clock shield
11	TMDS data 1/3 shield	23	TMDS clock+
12	N.C.	24	TMDS clock-

■RS-232C output terminal pins

(D-sub 9 pin)

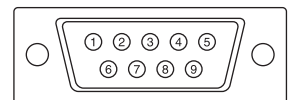

No.	Function	No.	Function
1	N.C.	6	N.C.
2	Received data	7	N.C.
3	Transmitted data	8	N.C.
4	N.C.	9	N.C.
5	GND		

SHARP[®]
SHARP CORPORATION