

# Dear SHARP Customer

Welcome to the SHARP Family. We are pleased that you are now the owner of a SHARP Color LCD Projector built for outstanding quality, reliability and performance. Every SHARP Color LCD Projector is adjusted for a proper picture and has passed through the most stringent quality control tests at the factory. We have prepared this OPERATION MANUAL so that you have the ability to adjust the picture and color to your personal viewing preference. We sincerely hope that you will be satisfied with the quality and performance of your Color LCD Projector for many years to come. Please read the instructions carefully, and keep them handy for future reference.

## IMPORTANT

For your assistance in reporting the loss or theft of your Color LCD Projector, please record the Serial Number located on the rear of the projector and retain this information.

**Model No.: PG-D100U**

**Serial No.:**

## Important Information

There are two important reasons for prompt warranty registration of your new SHARP LCD Projector, using the REGISTRATION CARD packed with the projector.

### 1) WARRANTY

This is to assure that you immediately receive the full benefit of the parts, service and labor warranty applicable to your purchase.

### 2) CONSUMER PRODUCT SAFETY ACT

To ensure that you will promptly receive any safety notification of inspection, modification, or recall that SHARP may be required to give under the 1972 Consumer Product Safety Act, PLEASE READ CAREFULLY THE IMPORTANT "LIMITED WARRANTY" CLAUSE. U.S.A. ONLY

**WARNING:** High brightness light source, do not stare into the beam of light, or view directly. Be especially careful that children do not stare directly into the beam of light.

**WARNING:** TO REDUCE THE RISK OF FIRE OR ELECTRIC SHOCK, DO NOT EXPOSE THIS PRODUCT TO RAIN OR MOISTURE.

<div style="display: flex; justify-content: space-between; align-items: center;"> <div style="text-align: center;"> <p><b>CAUTION</b></p> <p>RISK OF ELECTRIC SHOCK. DO NOT REMOVE SCREWS EXCEPT SPECIFIED USER SERVICE SCREW.</p> </div> </div>	<p>The lightning flash with arrowhead symbol, within an equilateral triangle, is intended to alert the user to the presence of uninsulated "dangerous voltage" within the product's enclosure that may be of sufficient magnitude to constitute a risk or electric shock to persons.</p>
<p style="text-align: center;"><b>CAUTION: TO REDUCE THE RISK OF ELECTRIC SHOCK, DO NOT REMOVE COVER. NO USER-SERVICEABLE PARTS EXCEPT LAMP UNIT. REFER SERVICING TO QUALIFIED SERVICE PERSONNEL.</b></p>	<div style="display: flex; justify-content: space-around; align-items: center;"> </div> <p>The exclamation point within a triangle is intended to alert the user to the presence of important operating and maintenance (servicing) instructions in the literature accompanying the product.</p>

**WARNING:** FCC Regulations state that any unauthorized changes or modifications to this equipment not expressly approved by the manufacturer could void the user's authority to operate this equipment.

U.S.A. ONLY

#### INFORMATION

This equipment has been tested and found to comply with the limits for a Class A digital device, pursuant to Part 15 of the FCC Rules. These limits are designed to provide reasonable protection against harmful interference when the equipment is operated in a commercial environment. This equipment generates, uses, and can radiate radio frequency energy and, if not installed and used in accordance with the instruction manual, may cause harmful interference to radio communications. Operation of this equipment in a residential area is likely to cause harmful interference, in which case the user will be required to correct the interference at his own expense.

U.S.A. ONLY

The enclosed RGB signal cable and Macintosh adaptor must be used with the device. The cable and adaptor are provided to ensure that the device complies with FCC Class A verification.

U.S.A. ONLY

## IMPORTANT SAFEGUARDS

Electrical energy can perform many useful functions. This unit has been engineered and manufactured to ensure your personal safety. But **IMPROPER USE CAN RESULT IN POTENTIAL ELECTRICAL SHOCK OR FIRE HAZARD**. In order not to defeat the safeguards incorporated into this LCD Projector, observe the following basic rules for its installation, use and servicing. For your own protection and reliable usage of your LCD Projector, please be sure to read these "Important Safeguards" carefully before use.

- 1) Read Instructions – All the safety and operating instructions should be read before the product is operated.
- 2) Retain Instructions – The safety and operating instructions should be retained for future reference.
- 3) Heed Warnings – All warnings on the product and in the operating instructions should be adhered to.
- 4) Follow Instructions – All operating and use instructions should be followed.
- 5) Cleaning – Unplug this product from the wall outlet before cleaning. Do not use liquid cleaners or aerosol cleaners. Use a damp cloth for cleaning.
- 6) Attachments – Do not use attachments not recommended by the product manufacturer as they may cause hazards.
- 7) Water and Moisture – Do not use this product near water – for example, near a bathtub, wash bowl, kitchen sink, or laundry tub; in a wet basement; or near a swimming pool; and the like.
- 8) Accessories – Do not place this product on an unstable cart, stand, tripod, bracket, or table. The product may fall, causing serious injury to a child or adult, and serious damage to the product. Use only with a cart, stand, tripod, bracket, or table recommended by the manufacturer, or sold with the product. Any mounting of the product should follow the manufacturer's instructions, and should use a mounting accessory recommended by the manufacturer.
- 9) A product and cart combination should be moved with care. Quick stops, excessive force, and uneven surfaces may cause the product and cart combination to overturn.



- 10) Ventilation – Slots and openings in the cabinet are provided for ventilation to ensure reliable operation of the product and to protect it from overheating, and these openings must not be blocked or covered. The openings should never be blocked by placing the product on a bed, sofa, rug, or other similar surface. This product should not be placed in a built-in installation such as a bookcase or rack unless proper ventilation is provided or the manufacturer's instructions have been adhered to.
- 11) Power Sources – This product should be operated only from the type of power source indicated on the marking label. If you are not sure of the type of power supply to your home, consult your product dealer or local power company. For products intended to operate from battery power, or other sources, refer to the operating instructions.
- 12) Grounding or Polarization – This product is equipped with a three-wire grounding-type plug, a plug having a third (grounding) pin. This plug will only fit into a grounding-type power outlet. This is a safety feature. If you are unable to insert the plug into the outlet, contact your electrician to replace your obsolete outlet. Do not defeat the safety purpose of the grounding-type plug.
- 13) Power-Cord Protection – Power-supply cords should be routed so that they are not likely to be walked on or pinched by items placed upon or against them, paying particular attention to cords at plugs, convenience receptacles, and the point where they exit from the product.

# IMPORTANT SAFEGUARDS

---

- 14) Lightning – For added protection for this product during a lightning storm, or when it is left unattended and unused for long periods of time, unplug it from the wall outlet and disconnect the cable system. This will prevent damage to the product due to lightning and power-line surges.
- 15) Overloading – Do not overload wall outlets, extension cords, or integral convenience receptacles as this can result in a risk of fire or electric shock.
- 16) Object and Liquid Entry – Never push objects of any kind into this product through openings as they may touch dangerous voltage points or short-out parts that could result in a fire or electric shock. Never spill liquid of any kind on the product.
- 17) Servicing – Do not attempt to service this product yourself as opening or removing covers may expose you to dangerous voltage or other hazards. Refer all servicing to qualified service personnel.
- 18) Damage Requiring Service – Unplug this product from the wall outlet and refer servicing to qualified service personnel under the following conditions:
  - a) When the power-supply cord or plug is damaged.
  - b) If liquid has been spilled, or objects have fallen into the product.
  - c) If the product has been exposed to rain or water.
  - d) If the product does not operate normally by following the operating instructions. Adjust only those controls that are covered by the operating instructions, as an improper adjustment of other controls may result in damage and will often require extensive work by a qualified technician to restore the product to normal operation.
  - e) If the product has been dropped or damaged in any way.
  - f) When the product exhibits a distinct change in performance - this indicates a need for service.
- 19) Replacement Parts – When replacement parts are required, be sure the service technician has used replacement parts specified by the manufacturer or with the same characteristics as the original part. Unauthorized substitutions may result in fire, electric shock, or other hazards.
- 20) Safety Check – Upon completion of any service or repairs to this product, ask the service technician to perform safety checks to determine that the product is in proper operating condition.
- 21) Heat – The product should be situated away from heat sources such as radiators, heat registers, stoves, or other products (including amplifiers) that produce heat.

## About the Temperature Monitor Function:

- If the projector starts to overheat due to set-up problems or a dirty air filter, “TEMP.” will flash in the upper-left corner of the picture. If the temperature continues to rise, then the lamp will turn off, the TEMPERATURE WARNING indicator will flash, and after a 90-second cooling-off period the power will shut off. Refer to page 31, “Maintenance Indicators,” when the “TEMP.” warning appears in the picture.
- The cooling fan regulates the internal temperature, and its performance is automatically controlled. The sound of the fan may change during operation due to changes in the fan speed.

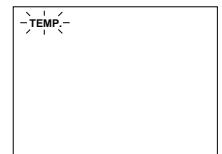

## About the Lamp Monitor Function:

- If the lamp is used for more than 1900 hours, “LAMP” will flash in yellow letters on the screen for 60 seconds, as shown on the right, when you turn the projector on. This is to alert you that it is time to replace the lamp. Replace the lamp according to the procedure given on page 32.
- When the number of hours the lamp is used reaches 2000, the power automatically turns off and the projector enters the standby condition.
- Refer to page 27, “Maintenance Indicators,” when the “LAMP” warning appears on the screen.

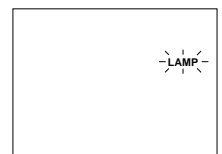

**Caution:** If “LAMP” begins to flash on the screen, be sure to replace the lamp.

# Cautions Concerning the Laser Pointer

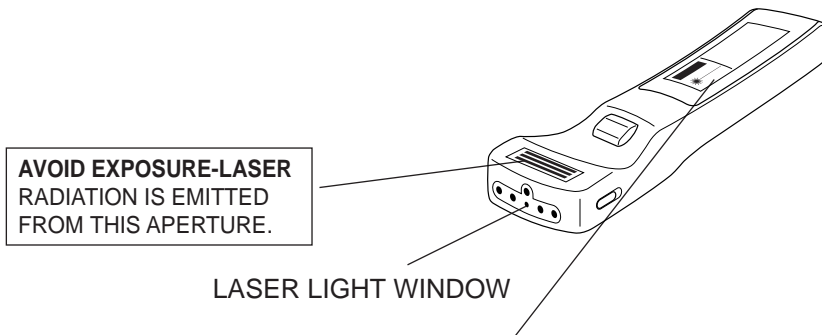

**CAUTION** - use of controls or adjustments or performance of procedures other than those specified herein may result in hazardous radiation exposure.

<b>CAUTION</b>	<b>"COMPLIES WITH 21 CFR SUBCHAPTER J"</b>	
 <p>LASER RADIATION- DO NOT STARE INTO BEAM</p> <p>WAVE LENGTH : 670nm MAX. OUTPUT : 1mW CLASS II LASER PRODUCT</p>	SHARP ELECTRONICS CORPORATION SHARP PLAZA, MAHWAH, NEW JERSEY 07430 TEL : 1-800-BE-SHARP <span style="border: 1px solid black; padding: 2px;">U.S.A. ONLY</span>	
	REMOTE CONTROL MODEL NO. : RRMCG1327CESA DC6V (1.5VX4PCS.) MADE IN JAPAN FABRIQUE AU JAPON	



The laser pointer on the remote control emits a laser beam from the laser light window shown in the figure above. The laser emitted is a class II laser; therefore, do not look into the laser window or shine the laser beam on yourself or other people. The three marks to the left are the caution labels for the laser beam.

Always use the laser pointer at temperatures between 41°F to 104°F (5°C to 40°C).

# Outstanding Features

## DIRECT COMPUTER COMPATIBILITY

A multi-scan RGB Input accepts signals from XGA (1024 dots × 768 lines compressed), SVGA (800 dots × 600 lines), VGA and Mac (832 dots × 624 lines maximum) compatible computers without the need for any additional hardware.

## HIGH PICTURE QUALITY

The three LCD panels contain 519,168 × RGB pixels to achieve exceptionally bright, high quality video images with up to 580 doubled TV lines of resolution.

## VERSATILE REMOTE CONTROL

- Built-in wireless mouse allows simultaneous operation of projector and computer.
- Built-in Laser Pointer for professional presentations.

## FLEXIBLE USE

- In addition to the standard front projection mode, the menu driven functions can be used to instantly reverse the image for rear projection, and invert the image for ceiling mounting.
- Screen projection size adjusts from 40 to 300 inches.

## BUILT-IN STEREO SPEAKERS WITH SRS (Sound Retrieval System) CIRCUITRY

Built in 3 W + 3 W stereo amplifiers and speakers feature SRS circuitry for impressive SRS 3-D sound.

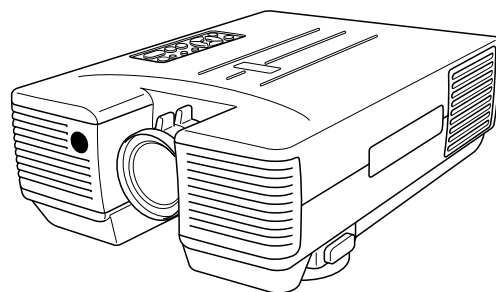

- (1) SRS, the SRS symbol "●" and "Sound Retrieval System" are registered trademarks of SRS Labs, Inc. in the U.S. and selected countries.
- (2) "Sound Retrieval System" (SRS) technology is manufactured under license from SRS Labs, Inc.
- (3) "Sound Retrieval System" (SRS) technology is protected by USA patents 4,748,669 and 4,841,572 and additional patents worldwide.

# Location of Controls

## FRONT VIEW

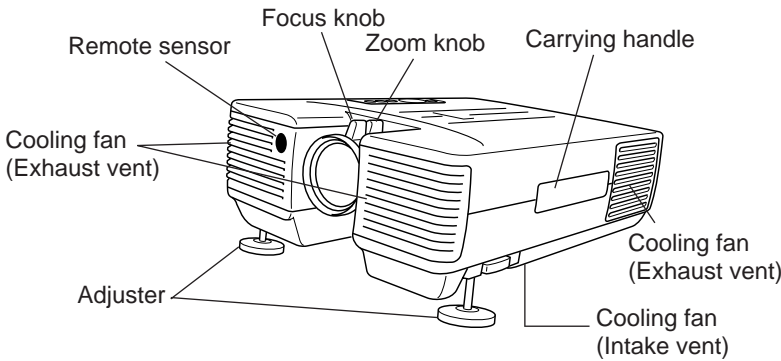

### CAUTIONS:

- Do not touch the lamp, lamp cage cover, cooling fan, and their surrounding areas while the projector is on. They are very hot and may cause burns.
- Allow at least 4" (10 cm) of space between the cooling fan (exhaust vent) and the other nearest wall or obstruction.
- If the cooling fan becomes obstructed, a protection device will automatically turn off the projector lamp. This does not indicate a malfunction. Remove the projector plug from the wall outlet and wait 10 minutes. Then turn on the power by plugging the cord back in. This will return the projector to its normal mode.

## OPERATION PANEL ON TOP OF PROJECTOR

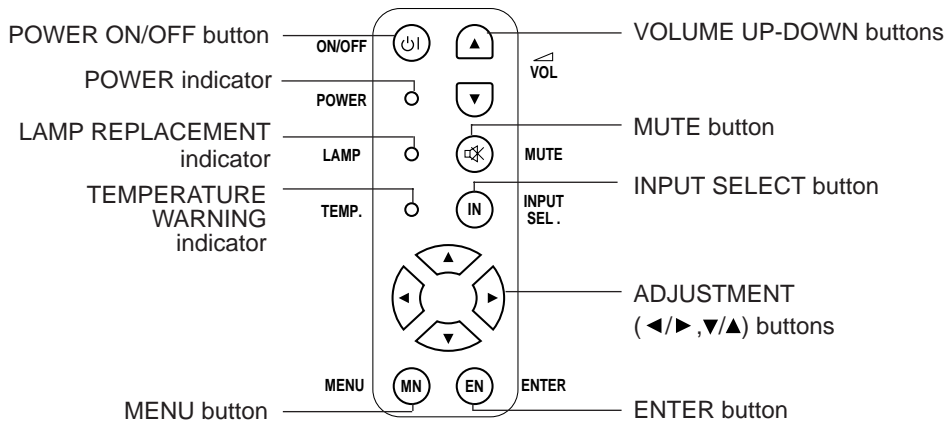

## REAR VIEW

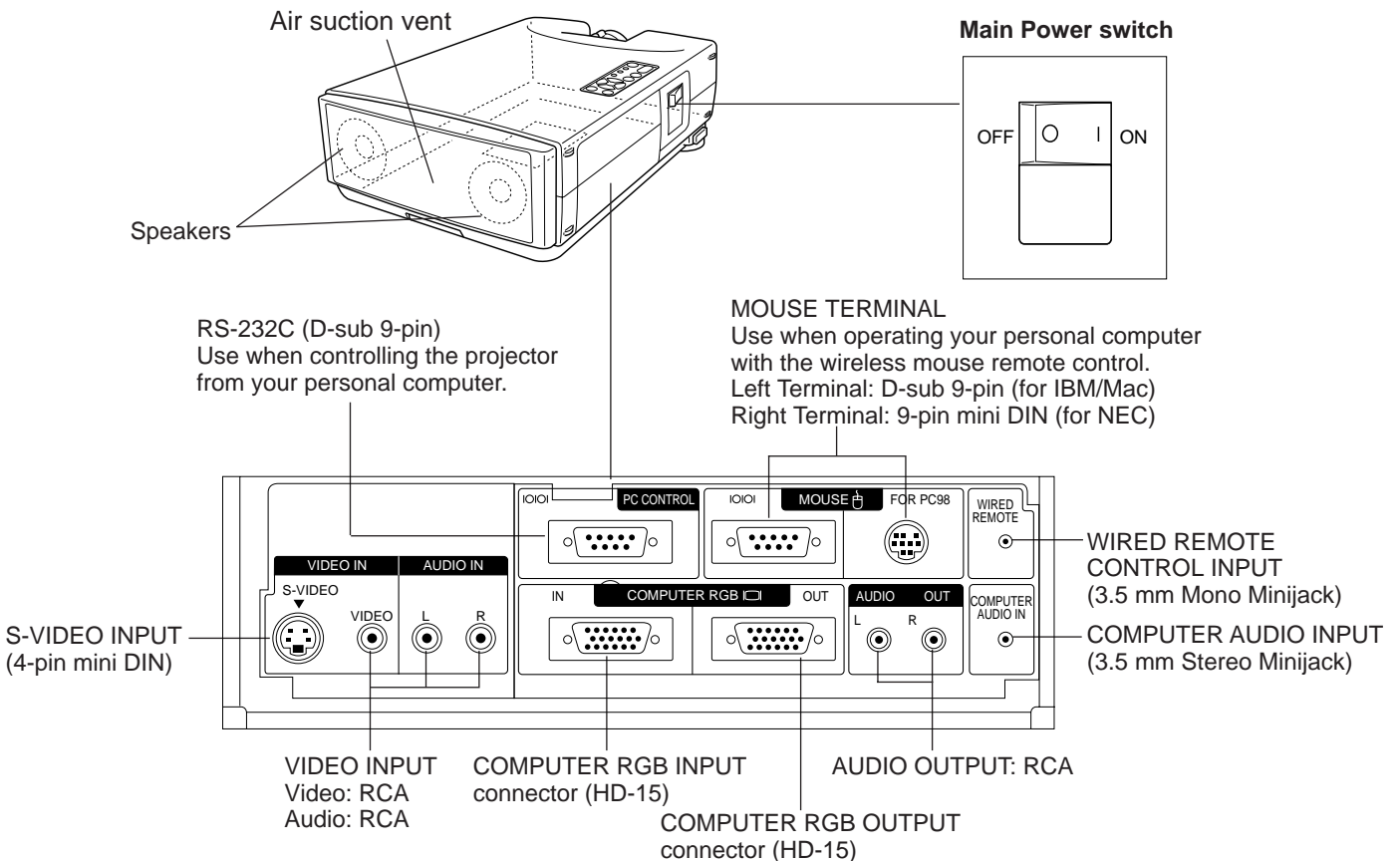

# Operating the Wireless Mouse Remote Control

The functions of your personal computer's mouse have been built into the remote control enabling you to operate your projector and personal computer with only the remote control.

1. Slide the main power switch on the side of the unit on.
2. Press the POWER ON button on the front panel of the remote control to turn the projector power on.
3. When using the remote control as a wireless mouse, move the MOUSE/ADJUSTMENT sliding switch to the MOUSE position. When using the remote control to operate the projector, move the MOUSE/ADJUSTMENT sliding switch to the ADJ. position. To activate the remote control key back-light feature, press the LIGHT button on the remote control. The colors of the buttons will change as shown in the table at the bottom of this page.

## Wireless Mouse Remote Control

### FRONT VIEW

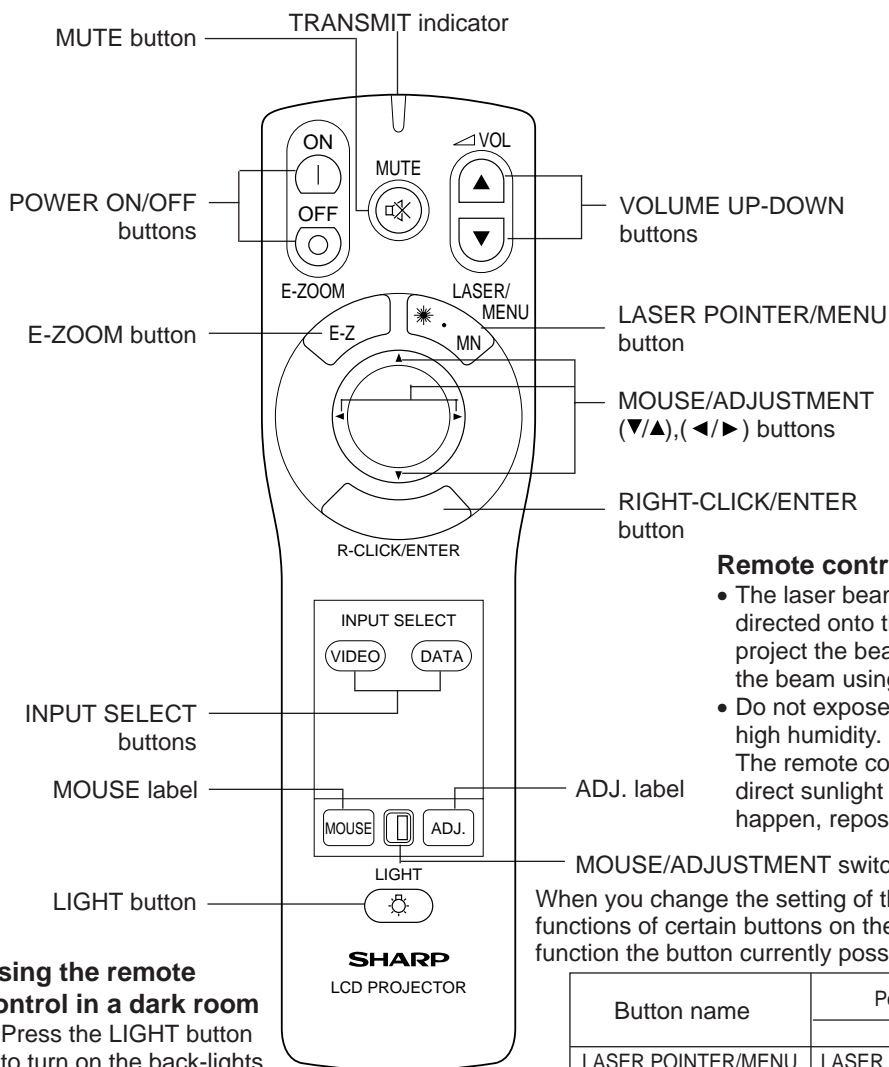

### SIDE VIEW

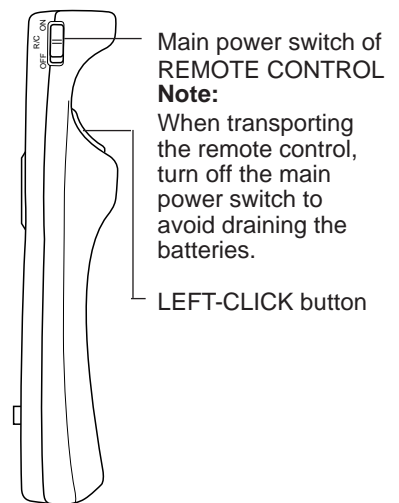

### Remote control handling precautions

- The laser beam used in this product is harmless when directed onto the skin, however please be careful not to project the beam directly into the eyes. Do not stare into the beam using any optical instrument.
- Do not expose the remote control to shocks, liquids or high humidity. The remote control may not operate normally if exposed to direct sunlight or other intense light sources. Should this happen, reposition the light source or the LCD Projector.

### Using the remote control in a dark room

- Press the LIGHT button to turn on the back-lights for the operation buttons for about 10 seconds. The back-light colors are explained in the table to the right.

When you change the setting of the MOUSE/ADJUSTMENT switch, the functions of certain buttons on the remote control change. You can tell which function the button currently possesses by the color of its back-light display.

Button name	Position of MOUSE/ADJUSTMENT Switch	
	MOUSE	ADJ.
LASER POINTER/MENU	LASER POINTER (GREEN)	MENU (RED)
RIGHT-CLICK/ENTER	RIGHT-CLICK (GREEN)	ENTER (RED)
MOUSE/ADJUSTMENT	MOUSE (NOT LIT)	ADJ. ▼/▲, ◀/▶ (NOT LIT)
LEFT-CLICK	Yes (NOT LIT)	—
POWER ON/OFF	Yes (RED)	
VOLUME UP-DOWN		
MUTE		
E-ZOOM		
VIDEO		
DATA		

If the main power switch on the remote control is left on and the remote control is not used for ten or more minutes, the energy save mode will activate and turn off the power. When in this state, any button operation exceeding one second will reactivate the power.

## TOP VIEW

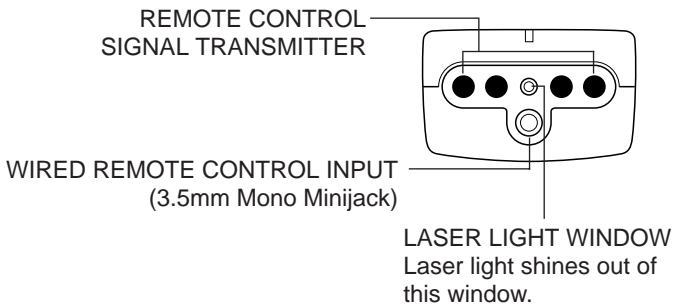

<p><b>CAUTION</b></p> <p>LASER RADIATION- DO NOT STARE INTO BEAM</p>  <p>WAVE LENGTH : 670nm MAX. OUTPUT : 1mW CLASS II LASER PRODUCT</p>	<p>"COMPLIES WITH 21 CFR SUBCHAPTER J"</p> <p>SHARP ELECTRONICS CORPORATION SHARP PLAZA, MAHWAH, NEW JERSEY 07430 TEL : 1-800-BE-SHARP [U.S.A. ONLY]</p>
	<p>REMOTE CONTROL MODEL NO. : RRMCG1327CESA DC6V (1.5VX4PCS.) MADE IN JAPAN FABRIQUÉ AU JAPON</p>



## Using the optional cable with the remote control

- When the remote control cannot be used due to the range or positioning of the projector (rear projection, etc.), connect the optional cable from the Wired Remote Control Jack of the remote control to the Wired Remote Input on the back of the projector.

### Note:

- The signal transmitter does not function when the optional cable is connected to the remote control.

The laser pointer on the remote control emits a laser beam from the laser light window shown in the figure above. The laser emitted is a class II laser; therefore, do not look into the laser window or shine the laser beam on yourself or other people. The two marks to the left are the caution labels for the laser beam.

Always use the laser pointer at temperatures between 41°F to 104°F (5°C to 40°C).

## REAR VIEW

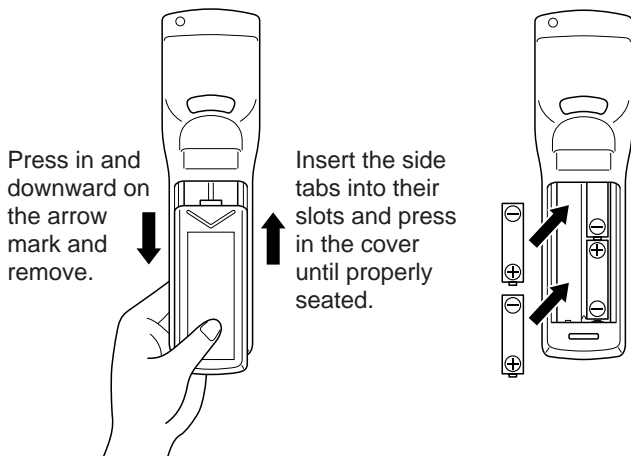

## Inserting the Batteries

Remove the battery cover as shown and insert four AA size batteries making sure their polarities match the (+) and (-) marks inside the battery compartment.

### Notes:

- Incorrect use of batteries may cause them to leak or burst.
- Insert the batteries with the (+) and (-) polarities as indicated.
  - Remove the batteries if the remote control will not be operated for an extended period of time.
  - Maintain the batteries in a clean condition.
  - Do not mix different brands of batteries. The life expectancy of the new batteries will be shortened and the old batteries may leak.
  - When the batteries have been used up, remove them immediately to prevent leakage and damage. Leaked battery fluid may irritate the skin. Remove any battery fluid by wiping with a cloth.
  - Due to storage conditions and the shelf life of the supplied batteries, they may run out after a short time. If so, replace them with new batteries as soon as possible.

### Transmission range

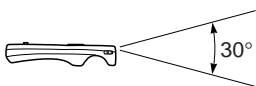

### Reception range

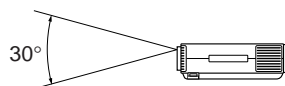

Max. distance: 23' (7 m)

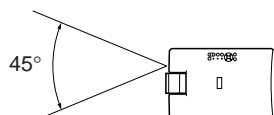
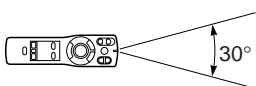

## Remote control positioning

Use the remote control as shown in the figures on the left.

### Note:

- The signal from the remote control can be reflected off the screen for easy operation. However, the effective distance of the signal may differ due to the screen material.

# Wireless Mouse Functions

By attaching the provided mouse cable to both the mouse terminal on your projector and the mouse terminal on your personal computer, you can use the wireless mouse built into the remote control, instead of the mouse equipped with your personal computer, to operate your personal computer. The wireless mouse functions will work with personal computers compatible with IBM PS/2, serial (RS-232C) or Apple ADB type mouse systems.

## Connection Example

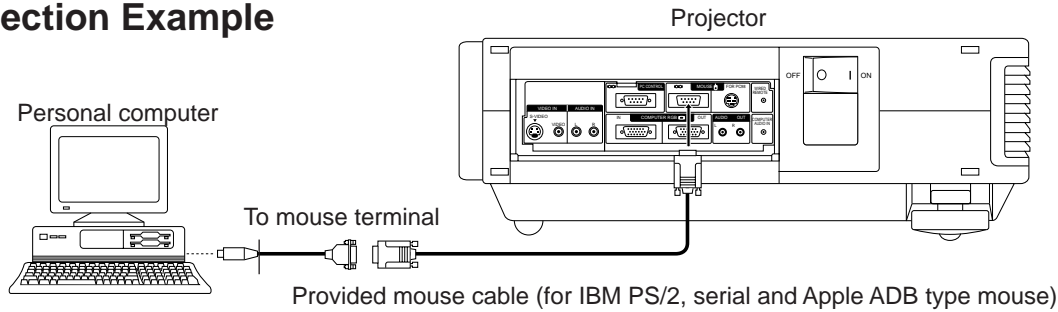

## Functions and Operations

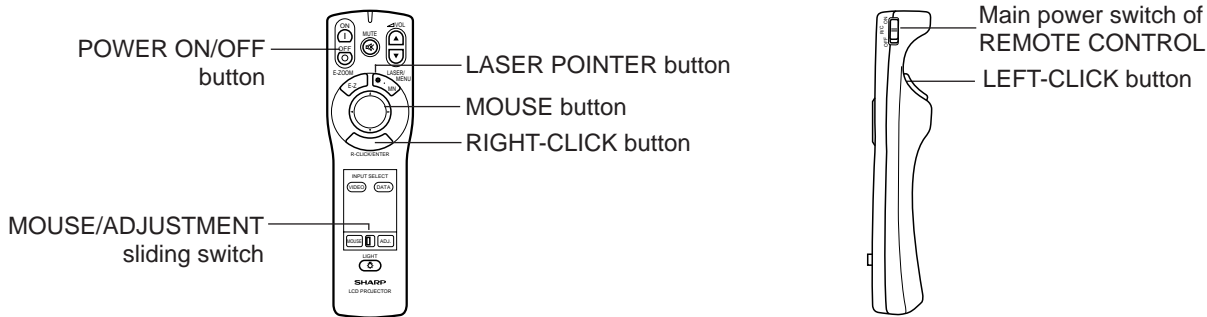

- First, connect the units as shown above, and turn the projector power on.
- Second, turn the computer power on.
- Next, slide the main power switch on the side of the remote control.
- When using the remote control as a wireless mouse, move the MOUSE/ADJUSTMENT sliding switch to the MOUSE position.

### Notes:

- In some situations the wireless mouse may be inoperable if your computer port is not correctly set-up. Please refer to your computer owners manual for details on setting-up/installing the correct Mouse Driver.
- Do not connect or remove the mouse control cable to/from your computer while it is on. This may damage your computer.
- Do not connect the mouse input terminal for IBM/MAC and the mouse input terminal for PC98 simultaneously.

## MOUSE buttons

By lightly pressing the up/down and right/left arrow buttons located on the front of the remote control, you can move the mouse cursor on your monitor screen.

### Note:

The amount of pressure applied to the mouse button determines the speed the mouse cursor travels. Pressing lightly on the periphery of the mouse button makes the mouse cursor move slowly. Pressing hard makes it move quickly.

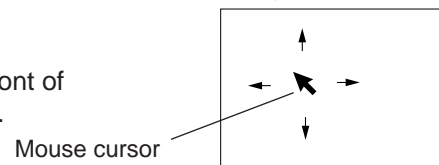

### LEFT-CLICK button

The LEFT-CLICK button on the back of the remote control corresponds to the left button of the mouse on two-button mouse systems.

### RIGHT-CLICK button

The RIGHT-CLICK button on the front of the remote control corresponds to the right button on two-button mouse systems.

### Note:

For one-button mouse systems use either the LEFT-CLICK or RIGHT-CLICK button.

### LASER POINTER button

Press the LASER POINTER button to activate the laser pointer.

When the button is pressed, the light stays on; when the button is released, the light goes off. However, even when the button is pressed continuously, the light automatically goes off 1 minute after it goes on. To turn it on again press the laser pointer button one more time.

<p><b>CAUTION</b></p> <p>LASER RADIATION- DO NOT STARE INTO BEAM</p> <p>WAVE LENGTH : 670nm MAX. OUTPUT : 1mW CLASS II LASER PRODUCT</p>	<p>"COMPLIES WITH 21 CFR SUBCHAPTER J"</p> <p>SHARP ELECTRONICS CORPORATION SHARP PLAZA, MAHWAH, NEW JERSEY 07430 TEL : 1-800-BE-SHARP [U.S.A. ONLY]</p>
	<p>REMOTE CONTROL MODEL NO. : RRMCG1327CESA DC6V (1.5Vx4PCS.) MADE IN JAPAN FABRIQUE AU JAPON</p>



The laser pointer on the remote control emits a laser beam from the laser light window. The laser emitted is a class II laser; therefore, do not look into the laser window or shine the laser beam on yourself or other people. The two marks to the left are the caution labels for the laser beam. Always use the laser pointer at temperatures between 41°F to 104°F (5°C to 40°C).



# Setting Up the Projector

## Using the Focus and Zoom

- Zoom, Focus and Reversed/Inverted Image mode functions broaden your options for projector placement.
- See pages 11 and 12 for details on projector setup.

### SIDE VIEW

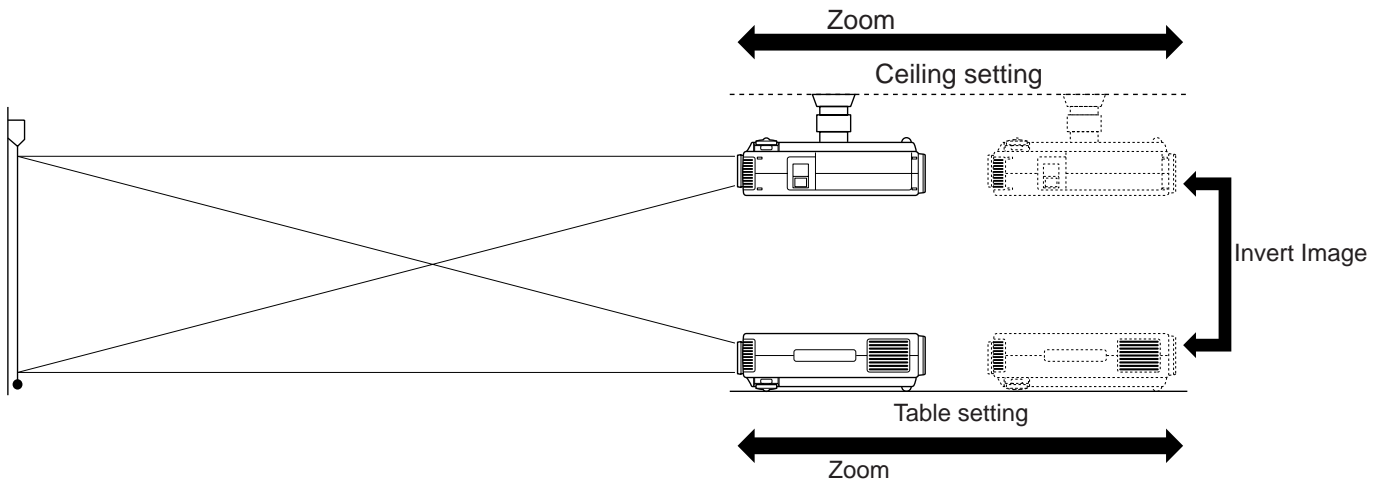

#### 1. Turn on the MAIN POWER.

Turn on the main power switch.

2

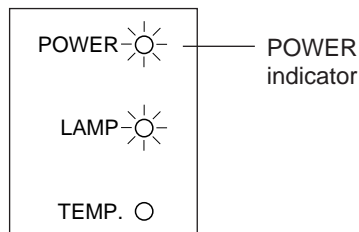

#### 2. Turn on the POWER

Press the POWER ON/OFF button on the projector or remote control to turn on the power.

3

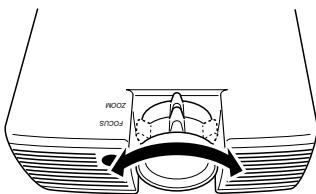

#### 3. Adjusting the Focus

Rotate the focus knob until the top portion of the screen is in focus.

4

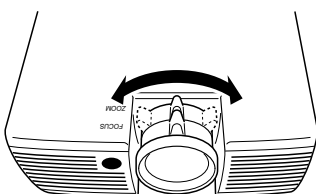

#### 4. Adjusting the Zoom

Rotate the zoom knob. The picture can be adjusted to the desired size within the zoom range.

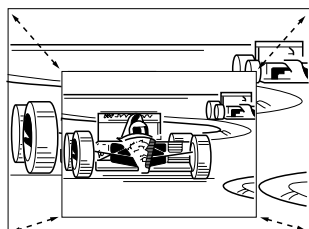

## Projector Distance and Picture Size Relationship

- The zoom lens allows adjustment of the image size within the projector's range.
- For optimum picture adjustment, the projector should be placed and adjusted at a distance between 5.1 ft to 56.3 ft from the screen.

### Distance from screen

Picture size: 100 inches (254 cm)

Picture size (diag.)	Projection distance (L)	
	Maximum projection distance	Minimum projection distance
300 inches	56.3 ft (17.2 m)	40.0 ft (12.2 m)
150 inches	28.0 ft (8.5 m)	19.9 ft (6.1 m)
100 inches	18.5 ft (5.7 m)	13.1 ft (4.0 m)
80 inches	14.8 ft (4.5 m)	10.4 ft (3.2 m)
60 Inches	11.0 ft (3.4 m)	7.8 ft (2.4 m)
40 inches	7.2 ft (2.2 m)	5.1 ft (1.5 m)

The formula for picture size and projection distance

$$y_1 = 0.0575 x - 0.097$$

$$y_2 = 0.041 x - 0.0943$$

x : Picture size (diag.) (inches)

y<sub>1</sub> : Maximum projection distance (m)

y<sub>2</sub> : Minimum projection distance (m)

**Note:**

There is an error of ± 4 inches (± 10 cm) in the formula above.

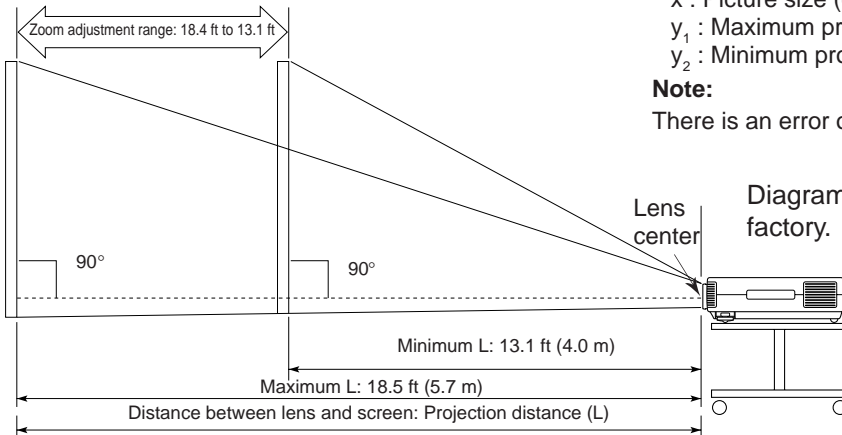
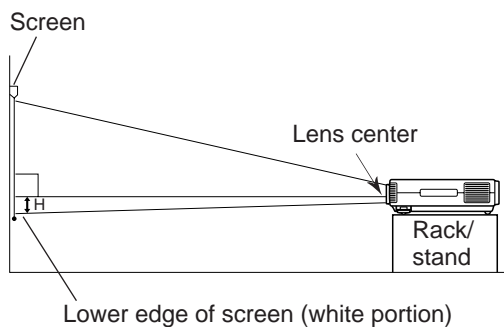

Diagram shows the lens shift position set at the factory.

- Above is an illustration of maximum and minimum projection distances for the PG-D100U with a picture size of 100 inches. Move the projector forward or back if the edges of the image are distorted.

### Height of projector

- Adjust to match the setup configuration.



Picture size (diag.)	Distance from lens center to lower edge of screen (H)
300 inches	25 <sup>63</sup> / <sub>64</sub> inches (66 cm)
150 inches	12 <sup>63</sup> / <sub>64</sub> inches (33 cm)
100 inches	8 <sup>21</sup> / <sub>32</sub> inches (22 cm)
80 inches	7 <sup>3</sup> / <sub>32</sub> inches (18 cm)
60 Inches	5 <sup>1</sup> / <sub>8</sub> inches (13 cm)
40 inches	3 <sup>35</sup> / <sub>64</sub> inches (9 cm)

#### • Ceiling Mount

When the projector is in the inverted position, use the upper edge of the screen as the base line.

**Note:**

- Optimal image quality can be achieved with the projector positioned perpendicular to the screen.

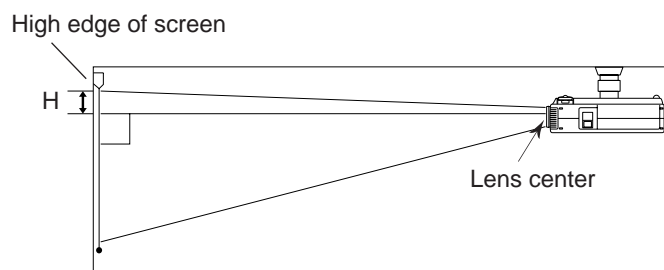

# Using the Image Invert/Reverse Function

■ This projector is equipped with an image invert/reverse function. The projected image can be inverted or reversed by using the MENU button and the ADJUSTMENT ▼/▲ and ◀/▶ buttons.

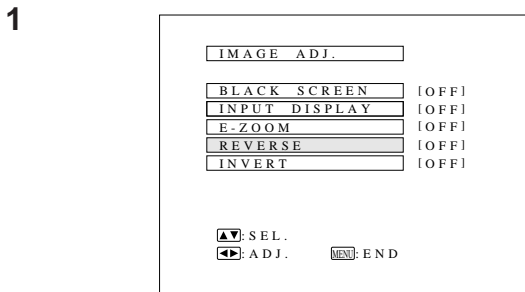

## 1. Press the MENU button.

With the MENU screen displayed, press the ADJUSTMENT ▼/▲ buttons to select IMAGE ADJ. Then press the ENTER button to display the IMAGE ADJ. screen.

- The last MENU screen selected is indicated for about 30 seconds.

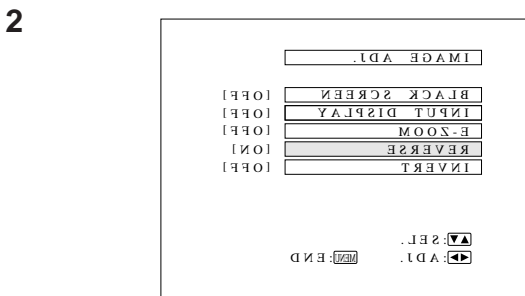

## 2. Reversed Image Mode

In the IMAGE ADJ. menu, press the ADJUSTMENT ▼/▲ buttons to select REVERSE. Then press the ADJUSTMENT ◀/▶ buttons to select ON. The reversed image will appear.

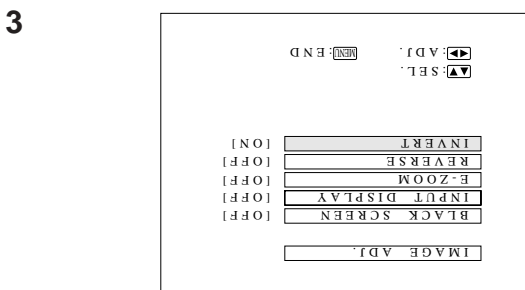

## 3. Inverted Image Mode

In the IMAGE ADJ. menu, press the ADJUSTMENT ▼/▲ buttons to select INVERT. Then press the ADJUSTMENT ◀/▶ buttons to select ON. The inverted image will appear.

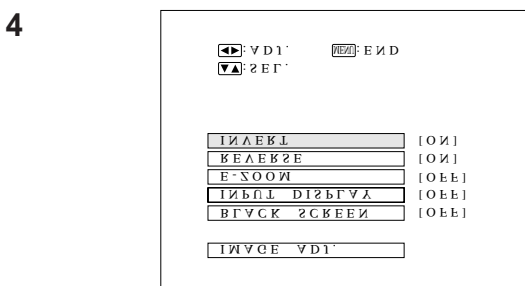

## 4. Reversed Inverted Image Mode

In the IMAGE ADJ. menu, set the REVERSE and INVERT functions to ON. The reversed inverted image will appear.

## 5. Press the MENU button anytime to exit IMAGE ADJ.

## How to set up the projector and screen

### Caution: When setting up the projector

- Do not place it in humid or dusty places, or places where the air is sooty or full of cigarette smoke. If the lens, mirror, or other optical components become dirty, the picture will blur or darken, making viewing difficult.
- Do not expose to extreme heat or cold.  
Operating temperature: 41°F to 104°F (5°C to 40°C)  
Storage temperature: -4°F to 132°F (-20°C to 60°C)
- Do not tilt the projector more than 5°.

■ Position the screen so that it is not in direct sunlight or room light. Light falling directly onto the screen washes out colors, making viewing difficult. Close the curtains and dim the lights when using the screen in a bright or sunny room.

■ The best picture will be obtained when the projector is at a 90 degree angle to the screen. Position the projector and screen as shown on the previous page.

## Example of a standard setup

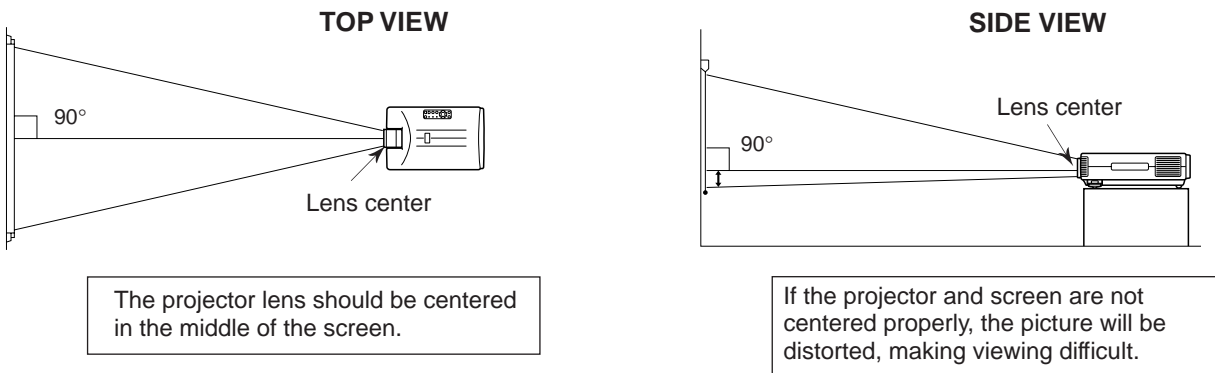

■ Using the horizontal reverse function makes the following setups possible.

## Example of a reversed image setup

- By placing a mirror (normal flat type) in front of the lens and using the horizontal reverse function, the image reflected from the mirror can be projected onto the screen.
- Rear projection with a rear projection screen is also possible when using the horizontal reverse function.

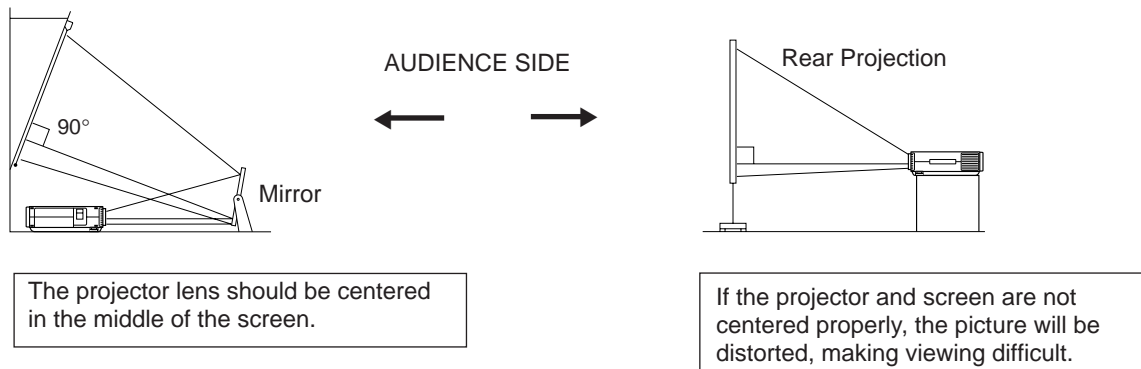

## Example of a ceiling-mount setup

Before mounting the projector, be sure to contact your nearest Authorized Sharp Industrial LCD Products Dealer to obtain the manufacturer recommended ceiling mount bracket (sold separately). (AN-XGCM10 Ceiling Mount Bracket, AN-EP101P Extension Tube).

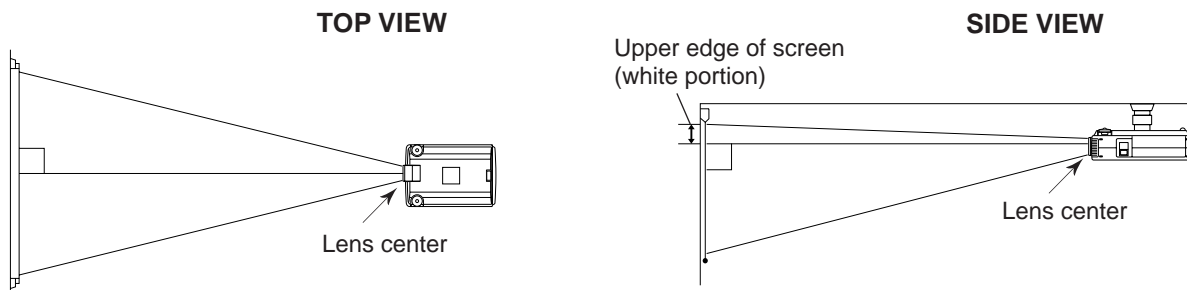

## Adjusting the Height of the Picture

Use the adjuster release to adjust the angle of the projector and height of the picture. Minor adjustments can be made with the adjusters.

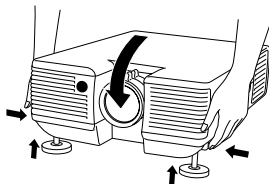
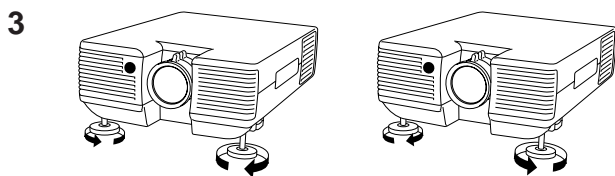
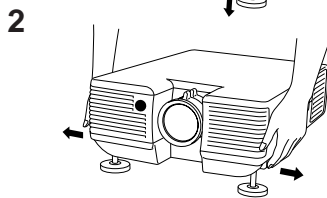
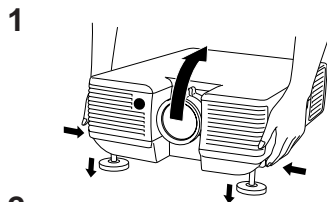
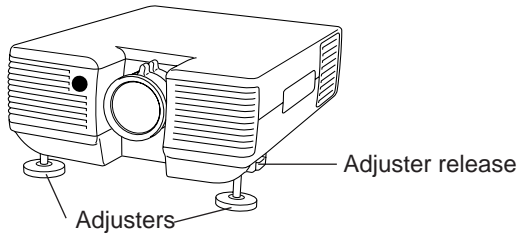

**1. Press the adjuster release and lift the projector to the desired angle with both hands.**

- The adjuster legs will extend to the surface of the table.

**2. Remove your hand from the adjuster release.**

- The adjuster legs will lock in position. Release the projector once you are sure the adjuster legs have locked in position.

**3. Make any minor adjustments necessary.**

- Turn the adjusters to further adjust the angle of the projector.

**Returning the projector to its original position**

- While holding the projector with both hands, press the adjuster release and slowly lower the projector to its original position.

**Notes:**

- Adjustable up to approximately 5° from the horizontal.
- When adjustments are made with the adjusters, the picture may become distorted, depending on the relative positions of the projector and the screen.
- After adjusting, in some cases, all of the adjusters' feet may not be resting on the table.  
To prevent the projector from wobbling, adjust the adjusters' feet so that they firmly contact the table.

**Cautions:**

- Do not press the adjuster release when the adjuster legs are extended without firmly holding the projector.
- When lowering the projector, be careful not to get your fingers caught in the area between the adjusters and the projector.
- Do not hold the lens when lifting or lowering the projector.

## Transporting the Projector

Use the carrying handle when carrying the projector

When transporting the projector, press the handle release located on the side of the unit to expose the handle and then carry it by the handle as shown. To close the handle, push it back into the side of the unit.

**Note:**

Always put on the lens cap to prevent damage to the lens when transporting the projector.

**Caution:**

Do not lift or carry the projector by the lens or the lens cover as this may damage the lens.

carrying handle

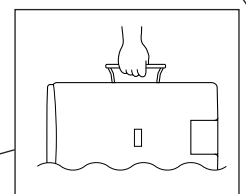
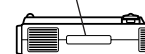

# Connecting the Projector

## Input terminals

This section explains how to connect the projector to audio/video equipment such as a VCR, Laser Disc, or external audio amplifier.

Always turn off the LCD Projector while connecting to video equipment, in order to protect both the projector and the equipment being connected.

- Press on the portion labeled PUSH and open the cover to make the necessary connections.

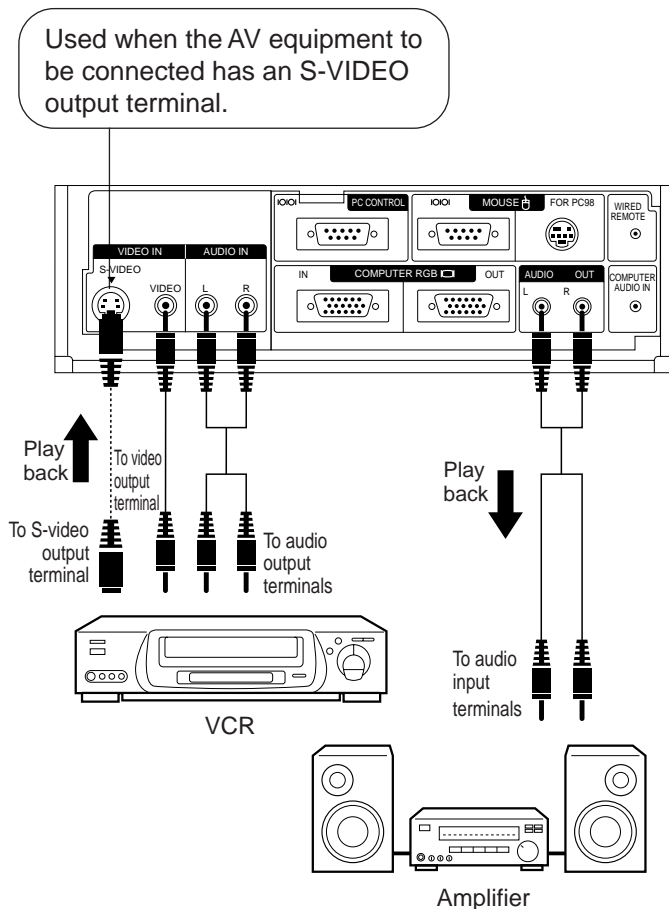

Note the following when using the S-VIDEO INPUT terminal:

- The S-VIDEO INPUT terminal uses a video signal system in which the picture is separated into a color and a luminance signal to realize a higher-quality picture.
- The S-VIDEO INPUT terminal has priority over the VIDEO INPUT terminal. Make the audio connection via the VIDEO INPUT audio terminals (left/right).
- The S-VIDEO INPUT terminal is used when the AV equipment to be connected has an S-VIDEO output terminal.

### Note:

- By using the external amplifier, the volume can be amplified for greater sound.

# Connecting the Projector (RGB: Computer)

- Please carefully read the manual of the computer you will be connecting.
- Before connecting, be sure to turn both the projector and the computer off. After making all connections, turn the projector on first. The computer should always be turned on last.

- Press on the portion labeled PUSH and open the cover to make the necessary connections.

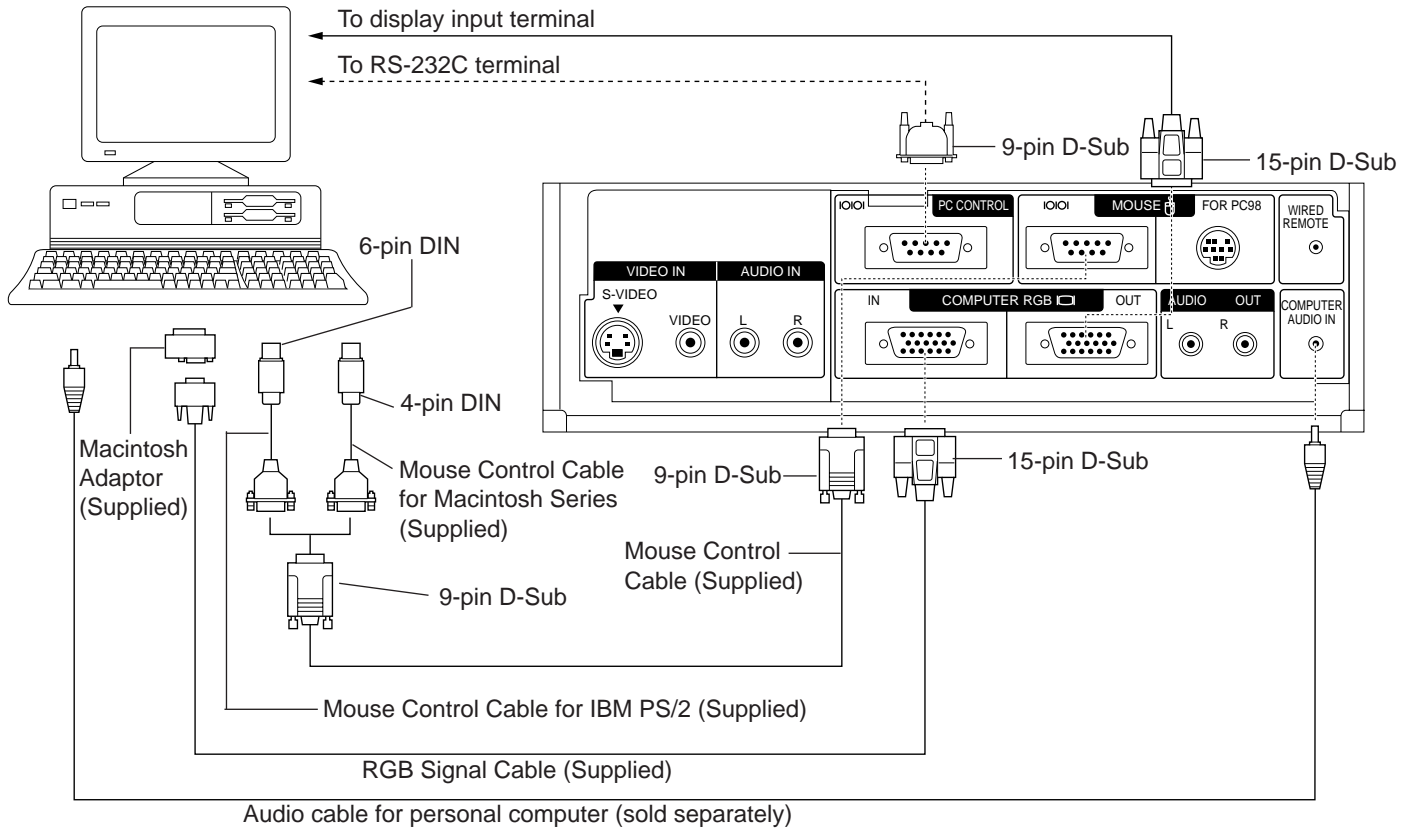

- You can connect your projector to a computer for easy projection of full color computer images and an external monitor for simultaneous viewing. See page 16 and 17 for details of the connections.
- Refer to page 18 for a list of personal computers connectable to the projector. Use with computers other than those listed may cause some of the functions not to work.
- When the RS-232C terminal on this unit is connected to a personal computer via an RS-232C cable (cross type), the personal computer can control the projector and the status of the projector can be checked. See page 35 and 36 for details.
- By connecting the projector mouse terminal to your personal computer's mouse terminal, using the supplied mouse control cables, you can use the remote control in place of the computer's mouse. Refer to page 8 for details.

## Notes:

- The wireless mouse or RS-232C function may not operate if your computer port is not correctly set-up. Please refer to your computer owners manual for details on setting-up/installing the correct Mouse Driver.
- Do not connect or remove the mouse control cable or RS-232C cable to/from your computer while it is on. This may damage your computer.
- Do not connect to the mouse input terminal for IBM/MAC and mouse input terminal for PC98 simultaneously.

# Connecting to the Computer RGB Input/Output Terminals

You can connect your projector to a computer for easy projection of full-color computer images, and an external monitor for simultaneous viewing.

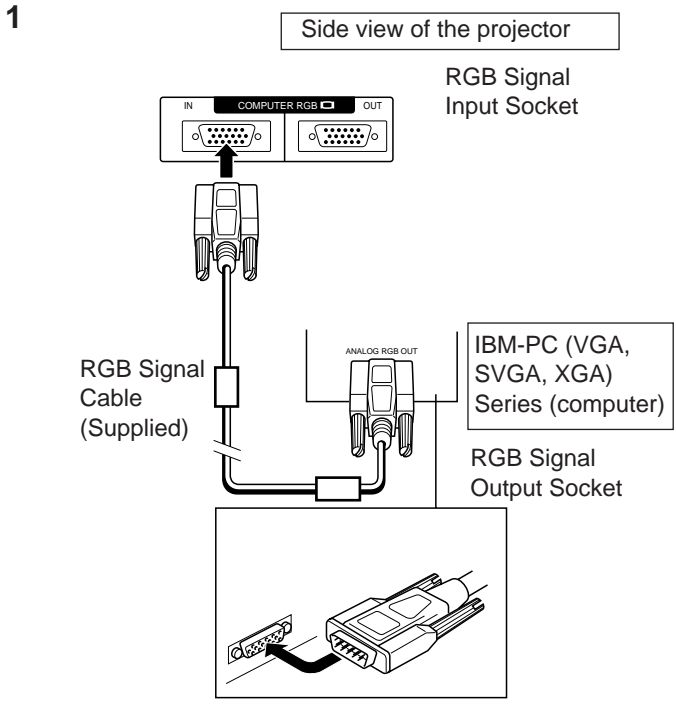

## 1. Connecting to an IBM-PC (VGA, SVGA, XGA) Series computer – 1,024 × 768 maximum resolution

Plug the RGB signal cable correctly into the RGB INPUT terminal on the projector and into the RGB signal output terminal on the computer, and secure the plugs by tightening the thumb screws.

- Note:**
- This connection is possible only when using a computer with a VGA/SVGA/XGA or Mac display output port.

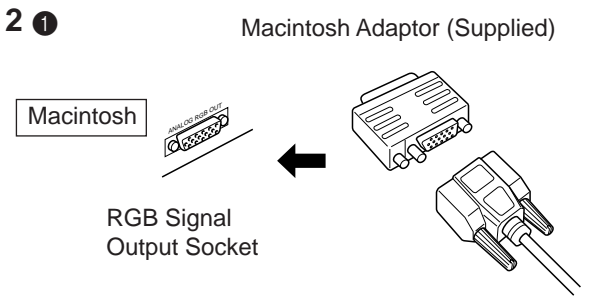

## 2. Connecting to a Macintosh Series Computer

- 640 × 480 resolution

① First, connect the supplied Macintosh adaptor to the RGB signal output terminal on your Macintosh Series computer, as shown on the left, and secure the plugs by tightening the thumb screws.

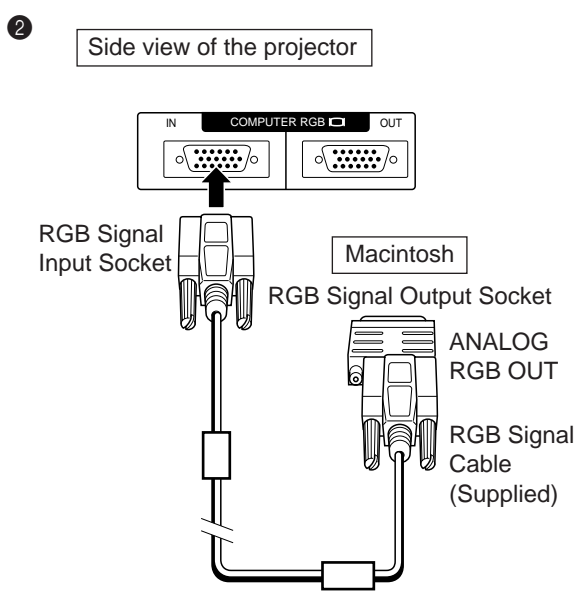

② Next, firmly plug the supplied RGB signal cable into both the RGB input terminal on the projector and the Macintosh adaptor on the computer, and secure the plugs by tightening the thumb screws.

- 832 × 624 resolution

When connecting in the 832 × 624 dot mode, use a Macintosh adaptor with display mode switching function available from your local computer dealer.



### 3. Connecting to other compatible computers

When connecting the projector to a compatible computer other than an IBM-PC (VGA/SVGA/XGA) or Macintosh series, a separate cable is needed. Please contact your dealer for ordering information.

**Notes:**

- Connecting computers other than the recommended types may result in damage to the projector, the computer, or both.
- Connect the audio from the computer to the COMPUTER AUDIO INPUT terminal.

### 4. Connecting to the COMPUTER RGB AUDIO INPUT

- RGB AUDIO INPUT accepts COMPUTER RGB input.
- Connect a 3.5 mm Stereo Minijack-RCA L/R cable (not included) from the audio output terminal on the computer to the COMPUTER AUDIO IN terminal on the projector.

4

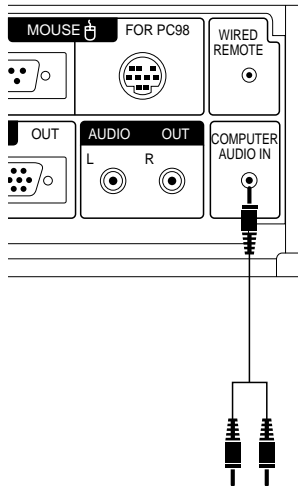

5

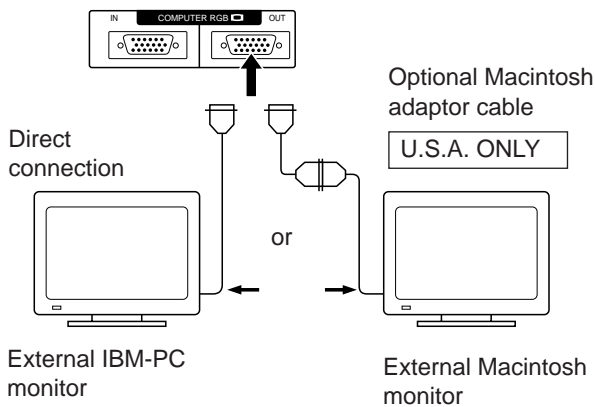

### 5. Connecting an external monitor

Connect your computer monitor to the projector's COMPUTER RGB OUTPUT terminal to view images simultaneously on the external monitor and the projection screen.

**Caution (Apple Macintosh)**

Do not connect the COMPUTER RGB OUTPUT to any monitor except the following:  
 Apple Color RGB Monitor 13"/14" (640 × 480) or  
 16"/17" (832 × 624)  
 The output signal from the projector to the monitor should be the same as the input signal from the computer to the projector.

**Example:** Input 13"/14" (640 × 480) → Output (640 × 480)  
 Input 16"/17" (832 × 624) → Output (832 × 624)

**Note:**

- When using the projector with an external IBM-PC monitor, connect the monitor using the supplied cable. When using the projector with a Macintosh monitor, an optional adaptor cable is required. Before using any other type of monitor, carefully check the monitor's interface specifications and make sure that they match the specifications of the projector's interface.

The external monitor output will only display an analog computer input signal. It will not display a digital or video input signal. To split the composite video signal, use a video distribution amplifier. This is available from your local dealer. The computer RGB output will only loop through the same signal connected to the computer RGB input. (VGA IN → VGA OUT, Mac IN → Mac OUT)

# Input Signals (Recommended Timing)

## For IBM and compatibles

Input signals: The video output signal timing of different types of video signals are shown below for reference.

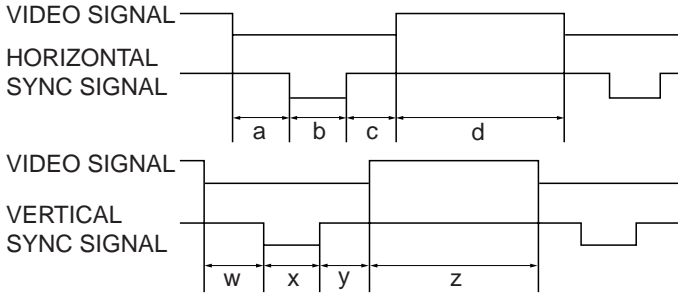

## For Apple Macintosh Series

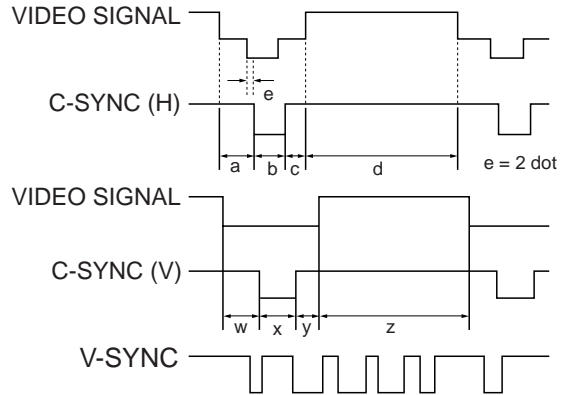

MODE		IBM						IBM	IBM	IBM	IBM	IBM	IBM	IBM	IBM	Apple	Apple	Apple	
		VGA						VESA	SVGA	SVGA	SVGA	SVGA	XGA	XGA	XGA	Macintosh™ IIsi	Macintosh™ LC	Macintosh™	
		TEXT		Graphic				Graphic	Graphic	VESA Guideline	VESA Standard	VESA Standard	VESA Guideline	VESA Standard	VESA Standard	13" Monitor	13" Monitor	16" Monitor	
		720 dot		640 dot				640 dot	800 dot	800 dot	800 dot	800 dot	800 dot	1024 dot	1024 dot	1024 dot	640 dot	640 dot	832 dot
		350 line	400 line	350 line	400 line	480 line	480 line	600 line	600 line	600 line	600 line	600 line	768 line	768 line	768 line	480 line	480 line	624 line	
VIDEO	LEVEL	0.7Vp-p 75Ω load						0.7Vp-p 75Ω load	0.7Vp-p 75Ω load	0.7Vp-p 75Ω load	0.7Vp-p 75Ω load	0.7Vp-p 75Ω load	0.7Vp-p 75Ω load	0.7Vp-p 75Ω load	1Vp-p max. 75Ω load	0.7Vp-p max. 75Ω load	0.7Vp-p max. 75Ω load		
	TYPE	R • G • B						R • G • B	R • G • B	R • G • B	R • G • B	R • G • B	R • G • B	R • G • B	R • G • B C.SYNC	R • G • B C.SYNC	R • G • B C.SYNC		
H S Y N C	FRONT PORCH	a	dot	17		14		24	24	40	56	16	24	24	16	64	78	31	
	SYNC	b	dot	108		96		40	72	128	120	80	136	136	96	64	62	65	
	BACK PORCH	c	dot	55		50		128	128	88	64	160	160	144	176	96	116	224	
	VIDEO PERIOD	d	dot	720		640		640	800	800	800	800	1,024	1,024	1,024	640	640	832	
	1H (a+b+c+d)	dot		900		800		832	1,024	1,056	1,040	1,056	1,344	1,328	1,312	864	896	1,152	
		μs		31.7774		31.7776		26.413	28.444	26.400	20.800	21.333	20.677	17.707	16.660	28.5714	28.595	20.124	
	1 dot	ns		35.3082		39.7219		31.746	27.777	25.000	20.000	20.202	15.385	13.3	12.7	33.0688	31.914063	17.468	
	1/H	kHz		31.4689		31.4688		37.860	35.156	37.879	48.077	46.875	48.363	56.476	60.023	35.0000	34.971149	49.693	
1/dot	MHz		28.322		25.175		31.500	36.000	40.000	50.000	49.500	65.000	75.0	78.75	30.2400	31.334149	57.246		
LEVEL			TTL	TTL	TTL		TTL	TTL	TTL	TTL	TTL	TTL	TTL	TTL	TTL	TTL	TTL		
SYNC POLARITY	+/-		+	-	+	-	-	+/-	+	+	+	-	-	+	-	-	-		
V S Y N C	FRONT PORCH	w	H	38	13	38	13	11	9	1	1	37	1	3	3	1	3	1	
	SYNC	x	H	2	2	2	2	2	3	2	4	6	3	6	6	3	3	3	
	BACK PORCH	y	H	59	34	59	34	32	28	22	23	23	21	29	29	28	39	39	
	VIDEO PERIOD	z	H	350	400	350	400	480	480	600	600	600	600	768	768	768	480	480	624
	1V (w+x+y+z)	H		449	449	449	449	525	520	625	628	666	625	806	806	800	525	525	667
		ms		14.2681	14.2681	14.2681	14.2681	16.6832	13.735	17.778	16.579	13.853	13.333	16.666	14.272	13.328	15.00	15.00	13.423
	1/v	Hz		70.0866	70.0866	70.0863	70.0863	59.9405	72.809	56.250	60.317	72.188	75.000	60.006	70.069	75.029	66.67	66.67	74.502
	LEVEL			TTL	TTL	TTL	TTL	TTL	TTL	TTL	TTL	TTL	TTL	TTL	TTL	TTL	TTL	TTL	
SYNC POLARITY	+/-		-	+	-	+	-	-	+/-	+	+	+	-	-	+	-	-		

### Notes:

- When connecting a notebook computer to the data-projector for display on a (800 × 600) LCD screen, the screen may not show a full picture image. See page 24, "Computer Mode Memory Adjustments" for details.
- This projector may not be able to display images from notebook computers in simultaneous (CRT/LCD) mode. If this occurs, turn off the LCD display on the notebook computer and output the display data in "CRT only" mode. Details on how to change display modes can be found in your notebook computer's operation manual.

# RGB Adjustment Controls

When displaying computer patterns which repeat every other dot (tiling, vertical stripes, etc.), interference may occur between the LCD pixels, causing flickering, vertical stripes, or contrast irregularities in portions of the screen. Should this occur, use the ADJUSTMENT ◀/▶ buttons for HORIZONTAL (LEFT/RIGHT) and VERTICAL (UP/DOWN) POSITION ADJUSTMENTS to adjust for the optimum picture.

## RGB INPUT ADJUSTMENTS (CLOCK, PHASE, V-POS and H-POS)

1. Select RGB with the INPUT SELECT button and press the MENU button to select the RGB INPUT ADJ. mode.

With the MENU screen displayed, press the ADJUSTMENT ▼/▲ buttons to select RGB INPUT ADJ. Then press the ENTER button to display the RGB INPUT ADJ. screen.

2

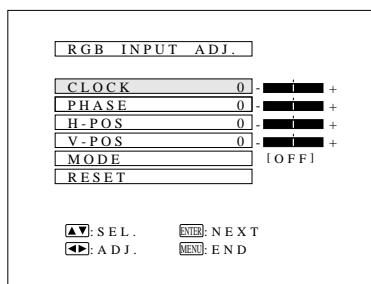

2. Select the item you wish to adjust with the ADJUSTMENT ▼/▲ buttons. Adjust the item with the ADJUSTMENT ◀/▶ buttons.

### Note:

To display only the item that you want to adjust, press the ENTER button after selecting the item with the ADJUSTMENT ▼/▲ buttons. Then adjust the item with the ADJUSTMENT ◀/▶ buttons.

3. Press the MENU button anytime to exit RGB INPUT ADJ.

## Description of Adjustment Items

### CLOCK SPEED ADJUSTMENT (FAST/SLOW)

- Adjust the input signal horizontal frequency and the dot clock so that the screen display is normal.

### PHASE ADJUSTMENT (UP/DOWN)

- Used to reduce image distortion or improve contrast.

### HORIZONTAL POSITION ADJUSTMENT (LEFT/RIGHT)

- Used to center the on-screen image by moving it to the left or right.

### VERTICAL POSITION ADJUSTMENT (UP/DOWN)

- Used to center the on-screen image by moving it up or down.

### MODE ADJUSTMENT

Connecting to IBM-PC Computers

- Ordinarily, the type of input signal is detected and the correct resolution mode (Text or Graphics) is automatically selected. However, for the following signals, set MODE to ON or OFF to select the projector's resolution mode to match the computer display mode properly.

720 dots × 400 lines, 720 dots × 350 lines (Text Mode)

640 dots × 400 lines, 640 dots × 350 lines (Graphic Mode)

- For graphic mode, select MODE and set the MODE to ON.
- For text mode, select MODE again at this time, and set MODE to OFF.

Connecting to Macintosh LC/II Series Computers

- When connecting to a Macintosh II with 35 kHz Dot Frequency, select MODE and set MODE to ON.
- When connecting to a Macintosh LC Series computer with 34.97 kHz Dot Frequency, set MODE to OFF.
- When connecting to third party video cards and other Macintosh computers, set MODE to ON or OFF to select the correct display mode.
- When the input signal is automatically detected or when there is no input signal, MODE (---) appears on the screen and the display mode cannot be changed.

### INITIAL RESET

- To return the H-POS, V-POS, PHASE and CLOCK adjustments to their initial settings, select RESET and then press the ENTER button.

### Notes:

- Flickering, vertical stripes, or contrast irregularities may also occur when the image is reversed. Once again, use the ADJUSTMENT ◀/▶ buttons for HORIZONTAL (LEFT/RIGHT) and VERTICAL (UP/DOWN) POSITION ADJUSTMENTS to adjust for the optimum picture.
- Avoid displaying computer patterns which repeat every other line (horizontal stripes). (Flickering may occur, making the picture hard to see.)

# Basic Operation of the Projector

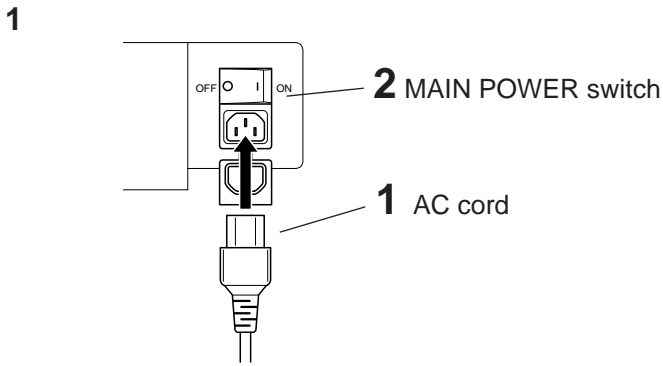

## 1. Connect the AC cord

Open the socket cover and connect the supplied AC cord to the socket.

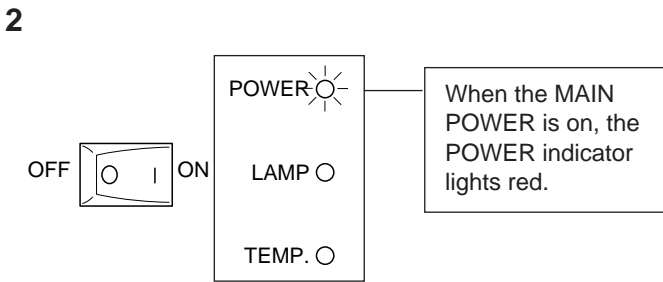

## 2. Turn on the MAIN POWER

Turn the MAIN POWER switch on the side of the projector. The POWER indicator lights red and the projector enters STANDBY mode.

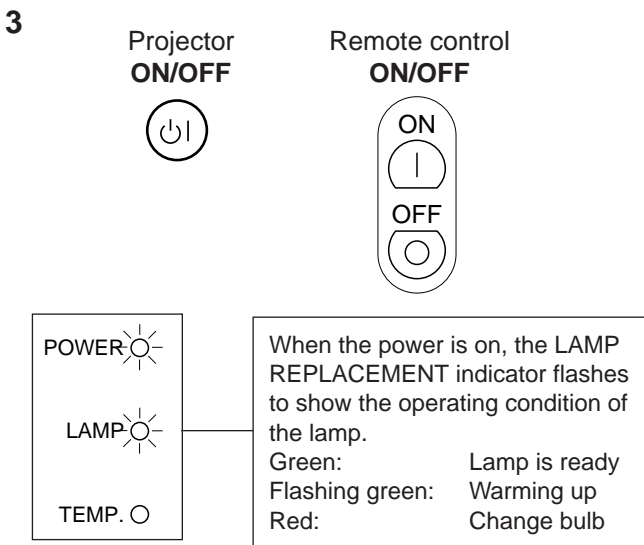

## 3. Turn on the POWER

Press the POWER ON/OFF button on the projector or the POWER ON button of the remote control.

- When the power is turned off by pressing the POWER ON/OFF button, the POWER indicator will not turn off until the fan has stopped running.
- See page 31, "Lamp/Maintenance Indicators" for details.

### Notes:

- When the POWER indicator is not lit, the remote control cannot be used to operate the projector.
- If the power is turned on immediately after it has been turned off, it may take a short while before the lamp turns on. (During this period the LAMP REPLACEMENT indicator flashes.)
- After the projector is unpacked and turned on for the first time, a slight odor may be emitted from the exhaust fan. This odor will soon disappear with use.

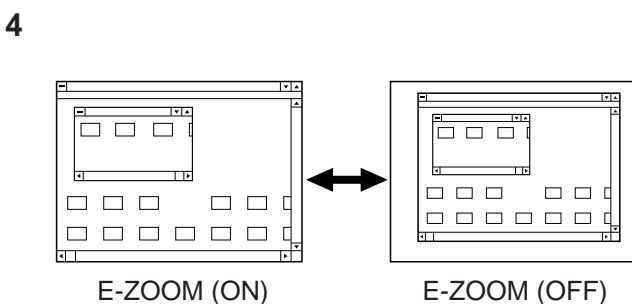

## 4. E-ZOOM Function

This projector has an E-ZOOM mode which enlarges the display when inputting an image of less than 800 × 600 dots in size. The E-ZOOM button of the remote control is used to operate E-ZOOM function.

See page 26, "E-ZOOM Function" for details.

### Notes:

- E-ZOOM function does not operate with monochrome images or in SVGA (800 × 600), Mac 16" (832 × 624), NTSC, PAL or SECAM INPUT mode.
- The picture size differs in RGB, NTSC, PAL and SECAM INPUT modes.

## On-Screen Display

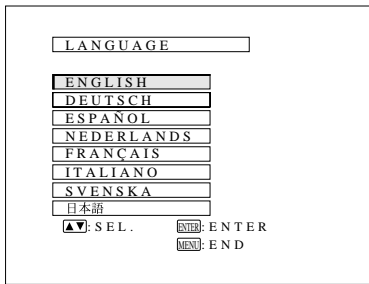

## 5. Select one of eight ON-SCREEN DISPLAY languages

You can return to the previous screen by selecting the uppermost item (turquoise) with the ADJUSTMENT ▼/▲ buttons (in this case, LANGUAGE) and then pressing the ENTER button.

The on-screen display is set to English at the factory. The language for the unit's ON-SCREEN DISPLAY can be set to English, German, Spanish, Dutch, Swedish, Italian, French or Japanese.

### Setting the ON-SCREEN DISPLAY language

- 1) Press the MENU button. The menu will appear on the screen.
- 2) Press the ADJUSTMENT ▼/▲ buttons to highlight the LANGUAGE item yellow. Then press the ENTER button to display the language menu.
- 3) Press the ADJUSTMENT ▼/▲ buttons to highlight the desired language yellow. Then press the Enter button to set the language. The ON-SCREEN DISPLAY is now programmed to display in the language chosen.

## On-Screen Display

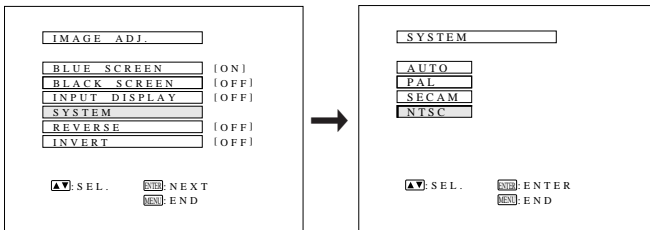

## 6. Change the system mode

The video input system mode is set to AUTO at the factory. If you connect a video device with a video signal supported by the projector and the video image appears with no colors, or other such problem occurs, set the video input system mode manually by following the procedure below.

- 1) Press the MENU button. The menu will appear on the screen.
- 2) Press the ADJUSTMENT ▼/▲ buttons to highlight the IMAGE ADJ. yellow. Then press the ENTER button to display the IMAGE ADJ.
- 3) Press the ADJUSTMENT ▼/▲ buttons to highlight SYSTEM yellow. Then press the ENTER button to display the SYSTEM.
- 4) Press the ADJUSTMENT ▼/▲ buttons to highlight the video system desired yellow. Then press the ENTER button to set the system.

### Note:

- In AUTO mode, "PAL," "SECAM," or "NTSC" is displayed on the screen for a few seconds when the mode is changed with the INPUT SELECT button.

## On-Screen Display

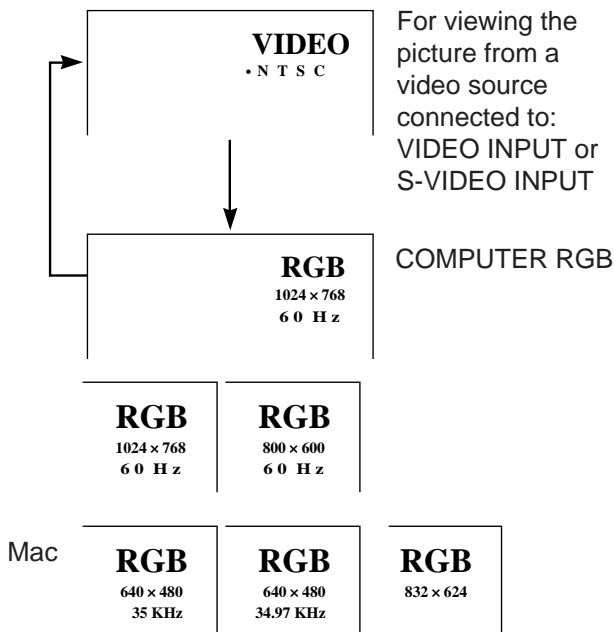

For viewing the picture from a video source connected to: VIDEO INPUT or S-VIDEO INPUT

COMPUTER RGB

## 7. Select input

Press the INPUT SELECT button to switch the picture input. When you press the button, the current input mode is displayed for about 4 seconds. If you press the button again while the input mode is displayed, the mode changes as shown on the left.

Confirm the selected input terminal and press the INPUT SELECT button.

### Notes:

- This can be selected directly using the VIDEO and DATA buttons on the remote control.
- In VIDEO mode, the system being received will be indicated below the "VIDEO" display.
- When selecting RGB mode, the resolution being displayed will be indicated under "RGB," as shown on the left. (Refer to the second example when connecting to Mac display.)
- When no signals are being received, "NO SIGNAL" will be displayed. When receiving a signal the projector is not preset to receive, "NOT REG." will be displayed. (This display function does not operate in Video mode.)

## 8. Adjust the volume

Press the VOLUME UP-DOWN buttons on the projector or on the remote control to adjust the volume.

### MUTE

- Press the MUTE button to temporarily turn off the sound.
- Press the MUTE button once again to turn the sound back on.

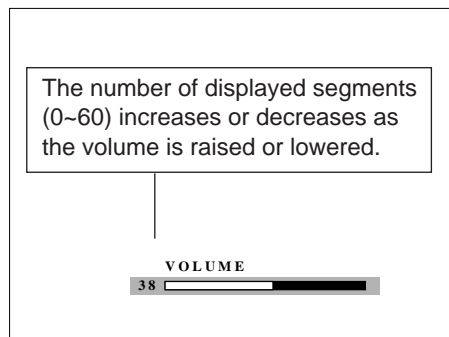

## 9. To turn off the power from the projector or remote control

The power can be temporarily turned off by pressing the POWER ON/OFF button on either the projector or remote control.

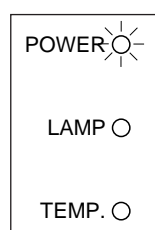

The POWER indicator will turn red and the cooling fan will run for 90 seconds, then the power will turn off, and the projector will return to STANDBY mode.

The power can be turned on again either from the projector or remote control. When the power is turned on, the POWER indicator and LAMP REPLACEMENT indicator light green.

### Note:

- When the MAIN POWER is off on the projector set, the power cannot be turned on from the remote control.

# Adjusting the Picture

- This projector's picture is factory preset to standard settings. However, you can adjust it to suit your own preferences with the ADJUSTMENT buttons on the projector and the remote control.
- The adjustments can be memorized in RGB or VIDEO separately.
- Four picture modes can be adjusted: "PICTURE," "BRIGHT," "RED," and "BLUE."

## Adjusting the Picture

### 1 On-Screen Display

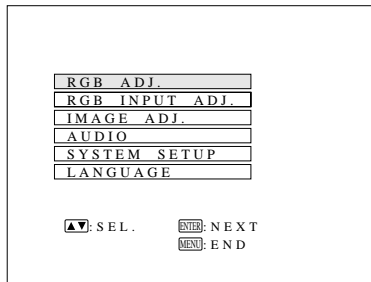

### 2

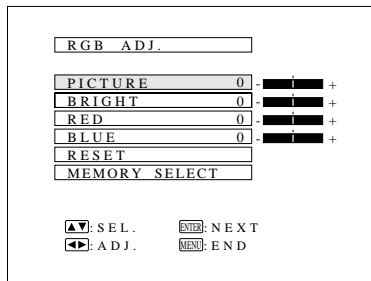

### 3

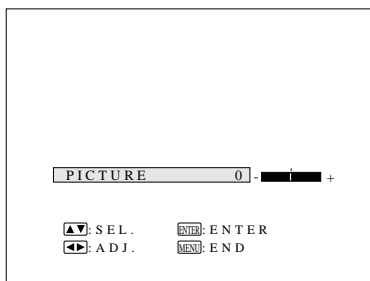

### 1. Use the MENU button to select the mode to be adjusted.

- When the MENU button is pressed, the MENU mode is indicated for about 30 seconds. Press the ADJUSTMENT ▼/▲ buttons to select "RGB ADJ.," then press the ENTER button.

### 2. Adjust the Picture

- Press the ADJUSTMENT ▼/▲ buttons to highlight the picture adjustment item you want to adjust yellow.
- Press the ADJUSTMENT ◀/▶ buttons to move the "0" mark of the selected adjustment item to the desired setting.
- The adjustment mode is displayed for about 30 seconds.

### Description of Adjustment Items

Selected item	ADJUSTMENT ◀ button	ADJUSTMENT ▶ button
PICTURE	For less contrast	For more contrast
BRIGHT	For less brightness	For more brightness
RED	For weaker red	For stronger red
BLUE	For weaker blue	For stronger blue
COLOR	For less color intensity	For more color intensity
TINT	Skin tones become purplish	Skin tones become greenish
SHARPNESS	For less sharpness	For more sharpness
RESET	All RGB Video Adjustment items are returned to the factory preset settings. Note: To reset all adjustment items, select RESET in "RGB ADJ. " mode and press ENTER button.	

### 3. Display Only the Item to Adjust

- Press the ADJUSTMENT ▼/▲ buttons to highlight the picture adjustment item you want to adjust yellow. If you press ENTER at this time, only the selected item will be displayed.
- Press the ADJUSTMENT ◀/▶ buttons to move the "0" mark of the selected adjustment item to the desired setting.
- The adjustment mode is displayed for about 30 seconds.

#### Notes:

- When a VIDEO signal input has been selected, only "PICTURE," "BRIGHT," "COLOR," "TINT" and "SHARPNESS" can be adjusted.
- TINT only appears in NTSC mode.

### 4. Press the MENU button anytime to exit RGB ADJ.

## Computer Mode Memory Adjustments

- The projector has been preset with different modes for use with SVGA and other compatible computers. However, 7 memory positions are provided to store mode adjustments.
- Each memory position can be used to store mode adjustments to match the computer.

### 1 When RGB is selected.

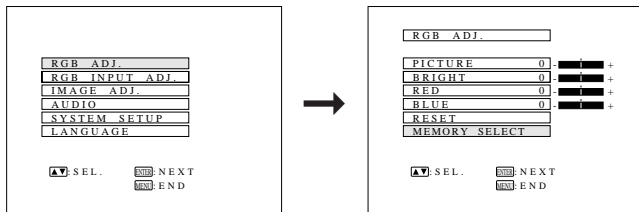

### 1. Press the ENTER button to select the Memory Adjustment mode.

- Press the MENU button. While the MENU screen is displayed, press the ADJUSTMENT ▼/▲ buttons to select “RGB ADJ.” Press the ENTER button. The MENU mode changes as shown.
- While the RGB adjustment menu is displayed, press the ADJUSTMENT ▼/▲ buttons to select “MEMORY SELECT.” Then press the ENTER button to change the image.

### 2

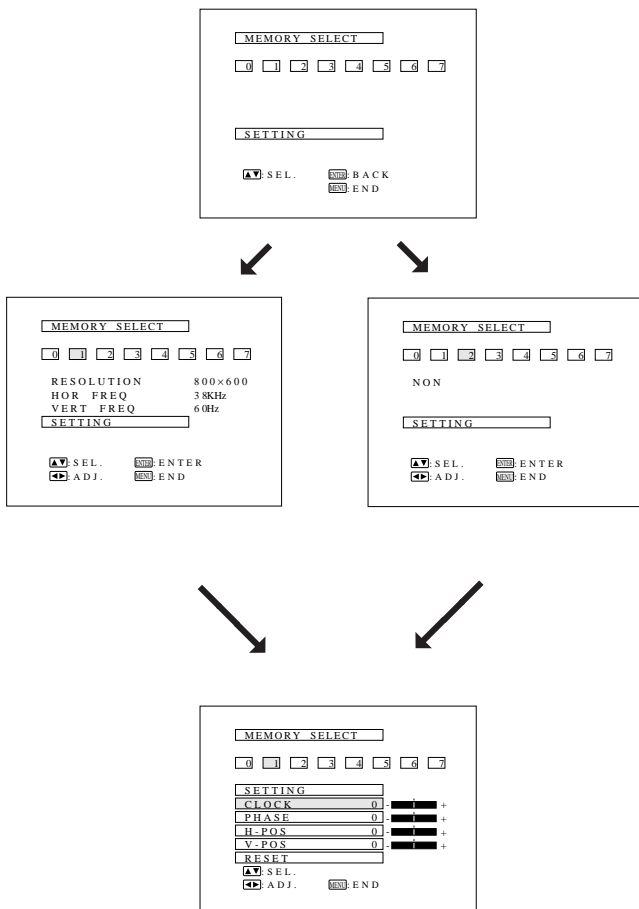

### 2. Press the ADJUSTMENT ◀/▶ buttons.

- The screen shown on the left will appear. There are 7 memory positions.
- Press the ADJUSTMENT ▼ button once to move to the following screen. Press the ADJUSTMENT ◀/▶ buttons to select the number of the memory you want to adjust. If that memory position has not been set, the screen on the right will be displayed. If it has been set, the screen on the left will be displayed. MEMORY No.0 cannot be set. It contains the fixed factory preset settings.
- To make or change a setting, press the ADJUSTMENT ▼/▲ buttons to move the cursor to “SETTING.” Then press the ENTER button to go to the next screen. (If you do not want to adjust any, press the MENU button.)
- Select the item you want to adjust by pressing the ADJUSTMENT ▼/▲ buttons, then use the ADJUSTMENT ◀/▶ buttons to make the adjustments. When adjustments are completed, press the MENU button. The display disappears and the adjustments are stored in memory as a user mode. See page 23 for details on the adjustment items.

### 3. Press the MENU button anytime to exit RGB ADJ.



# Adjusting the Audio

- The projector's audio is factory preset to the standard setting. However, you can adjust it to suit your own preference with the ADJUSTMENT buttons on the projector or the remote control.
- You can adjust the BALANCE, TREBLE and BASS, and also select the SRS 3-D SOUND mode.

- To return to the factory preset mode, press the ADJUSTMENT ▼/▲ buttons to select RESET, then press the ENTER button.
- Press the MENU button to select the normal screen mode.

## On-Screen Display

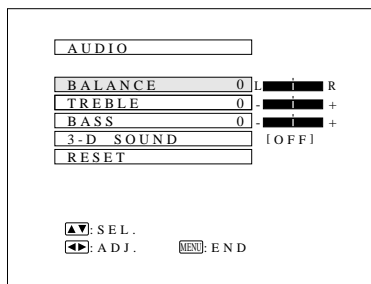

SRS 3-D SOUND (OFF)

## Adjusting the Balance, Treble, Bass

- Press the MENU button. Select AUDIO with the ADJUSTMENT ▼/▲ buttons. Then press the ENTER button to change to the picture indicated on the left.
- Select BALANCE, TREBLE or BASS with the ADJUSTMENT ▼/▲ buttons. Adjust the mode you want with the ADJUSTMENT ◀/▶ buttons.
- To return to the factory preset mode, press the ADJUSTMENT ▼/▲ buttons to select RESET, then press the ENTER button.

### Note:

When the SRS 3-D SOUND is turned on, the balance is reset.

### Description of Adjustment Items

Selected items	ADJUSTMENT ◀ button	ADJUSTMENT ▶ button
BALANCE	Increased audio from the left speaker	Increased audio from the right speaker
TREBLE	Weaker treble	Stronger treble
BASS	Weaker bass	Stronger bass

## Selecting and Adjusting the SRS 3-D SOUND Mode

The Sound Retrieval System is a sound system that recreates the effect of three dimensional acoustics. This allows one to enjoy a dynamic sound with a feeling of both width and depth.

- Press the MENU button. Select AUDIO with the ADJUSTMENT ▼/▲ buttons. Then press the ENTER button to change to the picture indicated on the left.
- Select SRS 3-D SOUND with the ADJUSTMENT ▼/▲ buttons. Then press the ADJUSTMENT ◀/▶ buttons to select ON, and press the ENTER button to change the image.
- The five types of SRS 3-D modes are listed below. Press the ADJUSTMENT ▼/▲ buttons to highlight the SRS 3-D mode desired yellow. Then press the ENTER button to set the SRS 3-D mode.

### Description of Adjustment Items

- Mode 1 Sound image that produces an intimate soundfield as in a medium-sized hall.
- Mode 2 Maximum soundfield as music comes out beyond the speakers.
- Mode 3 Great for live recording and vocal music.
- Mode 4 This setting greatly increases the amount of vocals or center sounds in a recording.
- Mono 3-D stereo sound from a monaural sound source.

## On-Screen Display

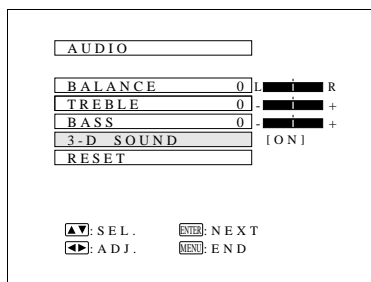

## On-Screen Display

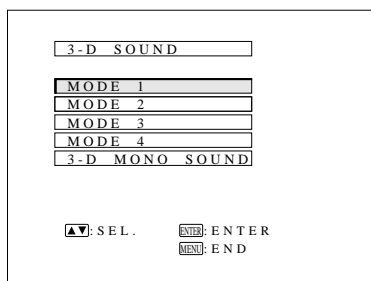

# E-ZOOM Function

## E-ZOOM Function

■ This projector has an E-ZOOM (640 × 480 dot, etc.) mode which enlarges the display when inputting an image of less than 800 × 600 dot in resolution. In the XGA (1024 × 768 dot) mode, compression enables full-mode display.

1

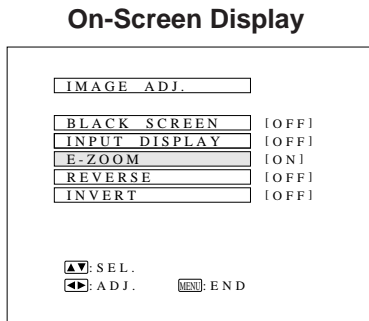

### 1. Press the MENU button to select E-ZOOM mode.

Press the MENU button. While the MENU screen is displayed, press the ADJUSTMENT ▼/▲ buttons to select IMAGE ADJ. Then press the ENTER button to display the IMAGE ADJ. screen as shown. Press the ADJUSTMENT ▼/▲ buttons to select E-ZOOM, and press the ADJUSTMENT ◀/▶ buttons to select ON. When the VGA (640 × 480 dot) is input, the projector will enter E-ZOOM mode.

E-ZOOM (ON): The screen image will be enlarged to 800 × 600 dot.

E-ZOOM (OFF): The resolution of the image does not change.

E-ZOOM (---): No input

#### Notes:

- Select ON 1 or ON 2 to set the status for either a 640 × 400 dot image or 640 × 350 dot image in the E-ZOOM mode.
- In the E-ZOOM mode, an enlarged display increases the amount of data processed on the screen and a compressed image decreases the number of lines displayed, which may make characters difficult to read.

2

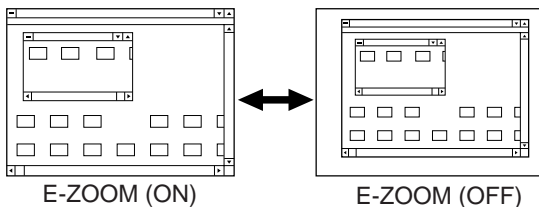

### 2. Press the E-ZOOM button on the remote control.

The E-ZOOM button on the remote control can be used to select E-ZOOM and NO E-ZOOM modes.

#### Note:

- In SVGA (800 × 600 dots) or Mac 16" (832 × 624 dots) mode, (---) appears, indicating the E-ZOOM function does not operate in this mode.

### 3. Press the MENU button anytime to exit E-ZOOM mode.

#### Notes:

- E-ZOOM function does not operate in SVGA (800 × 600), Mac 16" (832 × 624), NTSC, PAL, or SECAM INPUT modes.
- When connecting to some Mac 16" notebook computers, 832 × 624 dot signals may be output even in 640 × 480 mode, thus disabling the E-ZOOM function.
- When connecting to some SVGA notebook computers, 800 × 600 dot signals may be output even in 640 × 480 mode, thus disabling the E-ZOOM function.

# Functions on the Projector

## Setting Up the System

- Using this function, you can check the input signal and select the remote mouse.

### On-Screen Display

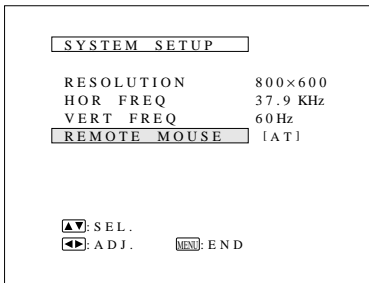
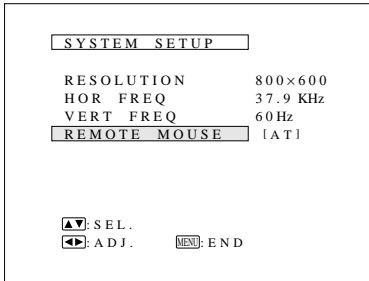

### Checking the system

- Press the MENU button. Select SYSTEM SETUP with the ADJUSTMENT ▼/▲ buttons. Then press the ENTER button to change to the picture indicated on the left.
- The current system conditions will be displayed on the screen.
- Press the MENU button to select the normal screen mode.

#### Note:

In the video screen, the resolution and frequency settings will not be displayed.

### Selecting the Remote Mouse

- Press the MENU button.
- Select SYSTEM SETUP with the ADJUSTMENT ▼/▲ buttons. Then press the ENTER button.
- Select REMOTE MOUSE and then select either [AT] or [98] with the ADJUSTMENT ◀/▶ buttons.
- Select [AT] when using IBM compatibles and Apple Macintosh series.
- Select [98] when using NEC PC98 series (for Japan).
- Press the MENU button to select the normal screen mode.

### Checking the Lamp Usage Time

The lamp usage time can be checked at the On-Screen Display.

- Press the INPUT SELECT button on the projector or remote control and select RGB INPUT.
- Press the ENTER button to select the Memory Adjustment mode.
- Press the MENU button. While the MENU screen is displayed, press the ADJUSTMENT ▼/▲ buttons to select "RGB ADJ." Press the ENTER button. The MENU mode changes as shown.
- While the RGB adjustment menu is displayed, press the ADJUSTMENT ▼/▲ buttons to select "MEMORY SELECT." Then press the ENTER button to change the image.
- Press the ADJUSTMENT ◀/▶ buttons and ENTER buttons.
- The screen shown on the left will appear.
- Press the ADJUSTMENT ▼ button once to move to the following screen.
- Using the ADJUSTMENT ◀/▶ buttons, select memory no. "1" and then press the ENTER button. Then, repeating the same procedure for each number separately, enter "7," "0," "1," "0," and "0."
- The lamp usage time will be displayed at the On-Screen Display for approximately 30 seconds.

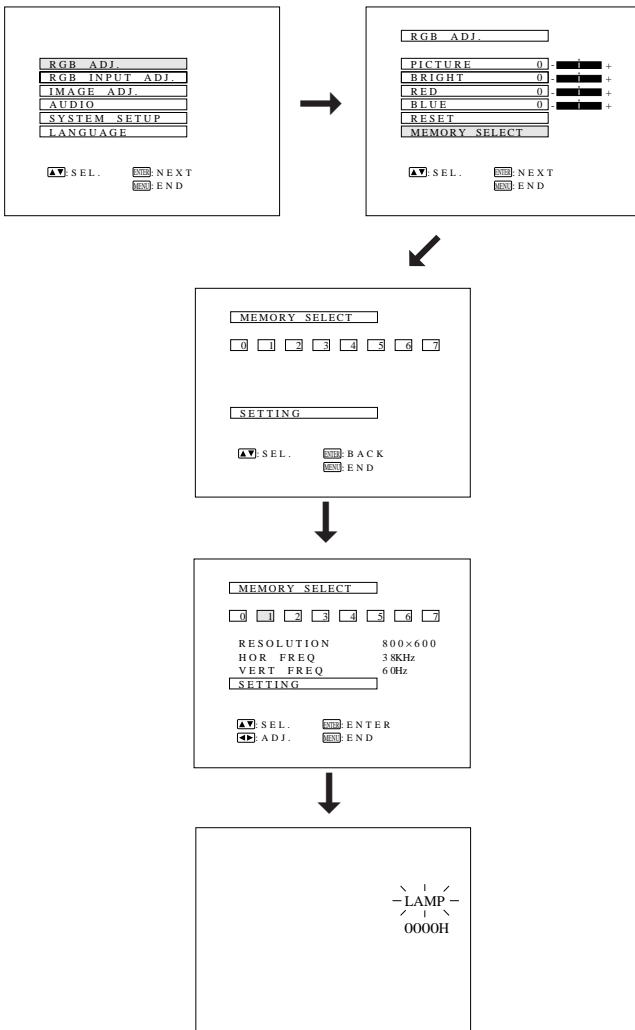

## On-Screen Display

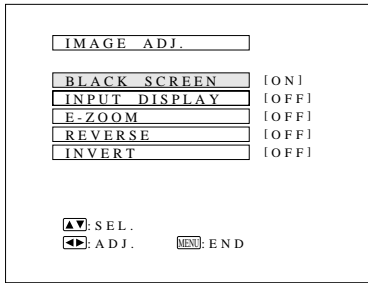

## LCD Projector

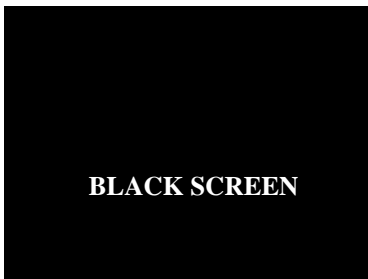
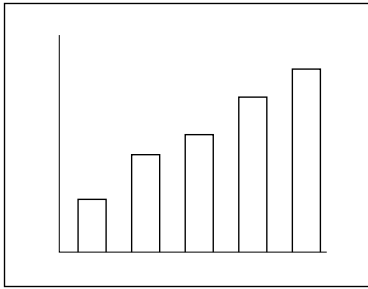

## Using the Black Screen Function

This projector is equipped with a Black Screen Function. This function can be used to black out the presentation image.

- Press the MENU button. While the MENU screen is displayed, press the ADJUSTMENT ▼/▲ buttons to select IMAGE ADJ. Then press the ENTER button to display the IMAGE ADJ. screen. Press the ADJUSTMENT ▼/▲ buttons to select "BLACK SCREEN," and press the ADJUSTMENT ◀/▶ buttons to select ON. Then press the MENU button to display the black screen.

### Note:

- When BLACK SCREEN is set to OFF, the screen will change to the presentation image when you press the MENU button.

## On-screen Display

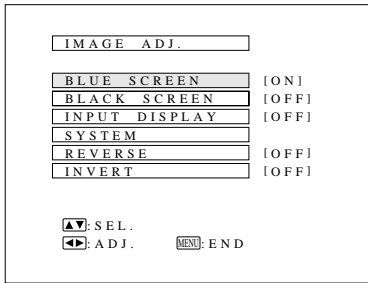

## On-screen Display

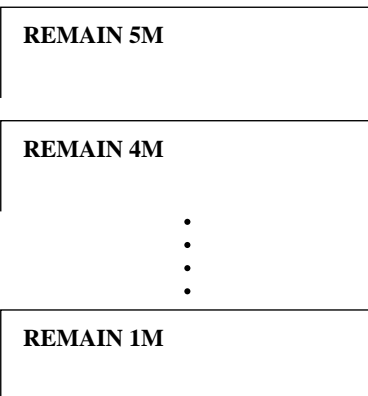

## On-screen Display

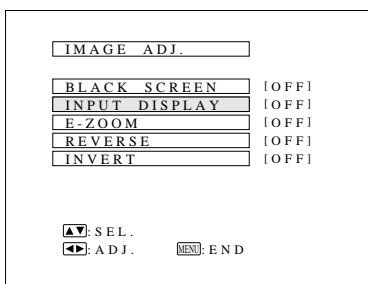

## Using the Blue Screen Function

This projector is equipped with a Blue Screen function that will turn the screen blue when the video input terminal is not connected to anything, or the video component is turned off.

- Press the MENU button. While the MENU screen is displayed, press the ADJUSTMENT ▼/▲ buttons to select IMAGE ADJ. Then press the ENTER button to display the IMAGE ADJ. screen as shown. Press the ADJUSTMENT ▼/▲ buttons to select “BLUE SCREEN,” and press the ADJUSTMENT ◀/▶ buttons to select ON or OFF. Press the MENU button to return to the normal screen.
- When the Blue Screen function is on, the screen will turn blue when no video signal is being input through the video input terminal.
- When the Blue Screen function is on, and no video signal is input via the input terminal for more than 15 minutes, the power is automatically turned off.
- The indicators appear as shown each minute before the power is turned off, from five minutes before until one minute before.

### Notes:

- The Blue Screen Function does not operate in RGB mode.
- When the power is turned off, the POWER indicator will light red.
- To turn the power on again, press the POWER button to set it to OFF, then press it again to set it to ON.

## Using the On-Screen Display Override Function

The On-Screen Displays (“RGB 1024 × 768, 60Hz,” etc.) that appear during input select can be turned off.

- Press the MENU button. While the MENU screen is displayed, press the ADJUSTMENT ▼/▲ buttons to select IMAGE ADJ. Then press the ENTER button to display the IMAGE ADJ. screen as shown. Press the ADJUSTMENT ▼/▲ buttons to select “INPUT DISPLAY,” and press ADJUSTMENT ◀/▶ buttons to select ON or OFF.
- When OFF is selected, the On-Screen Display (“RGB 1024 × 768, 60Hz,” etc.) will not be displayed during input select.



# Air Filter Maintenance

- The air filter should be cleaned every 100 hours of use. Clean the filter more often when the projector is used in a dusty or smoky location.
- Have your nearest Authorized Sharp Industrial LCD Products Dealer or Service Center replace the filter (PFILD 0051CEZZ) when it is no longer possible to clean it.

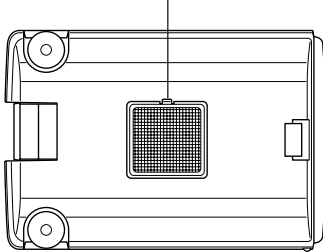
AIR FILTER cover

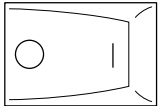
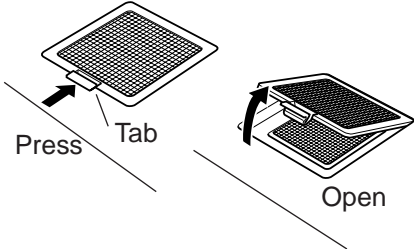
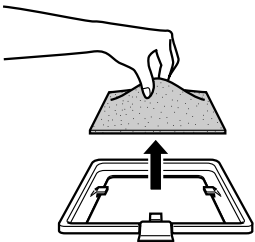

## Cleaning and Replacing the Filter

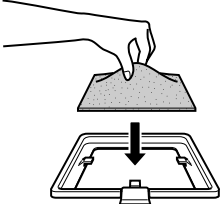
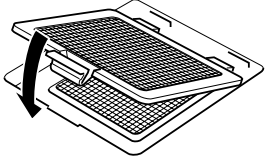
<p><b>1 Turn OFF the MAIN POWER.</b></p>	<p><b>2 Remove the FILTER COVER.</b></p>	<p><b>3 Remove the AIR FILTER.</b></p>
<p>OFF  ON</p> <p>POWER indicator goes off. Unplug the power cord.</p>	<p>Press the arrow mark on the air filter cover and pull straight out.</p>  <p>Press Tab Open</p>	<p>Grasp the air filter between your fingers and lift it out of the filter cover.</p> 
<p><b>4 Clean the AIR FILTER.</b></p>	<p><b>5 Replace the AIR FILTER.</b></p>	<p><b>6 Replace the FILTER COVER.</b></p>
<p>Clean the dust off the air filter and cover with a vacuum cleaner.</p> 	<p>Place the filter underneath the tabs on the filter frame. Return the air filter to its original position in the filter cover.</p> 	<p>Insert the two tabs on the end of the filter cover into the filter cover opening and press the filter cover into position.</p> 

**Note:**

- Be sure the AIR FILTER COVER is securely installed. The power cannot be turned on unless it is correctly installed.

# Lamp/Maintenance Indicators

## Lamp

- The Lamp has a finite operating life. The lamp for this projector has a usable life of 2000 cumulative hours. This number may differ, however, depending on the ambient conditions.
- 1. When the lamp is nearing the end of its operating life, the picture and color quality will deteriorate. If the lamp is used for more than 1900 hours, the LAMP REPLACEMENT indicator will light red and “LAMP” will flash in yellow letters on the screen when you turn the projector on to alert you that it is time to replace the lamp. In this situation, replace the lamp (See pages 32 and 33).

**Note:** The lamp usage time can be checked at the On-Screen display. (See page 27.)

**Caution:** Once you are alerted that the lamp requires replacement, be sure to replace the lamp.

- 2. When the number of hours the lamp is used reaches 2000, the power automatically turns off and the projector enters the standby condition. If you turn on the power after the lamp has been used for 2000 hours, “LAMP” will flash on screen in red letters for five minutes and then the power will turn off.
- 3. If the new lamp does not light after replacement, take your projector to the nearest Authorized Sharp Industrial LCD Products Dealer or Service Center for repair.
- 4. Intense light hazard. Do not attempt to look into the aperture and lens while the projector is operating.

## Maintenance Indicators

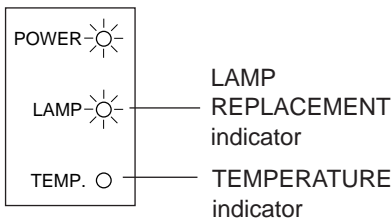

- The warning lights on the projector indicate problems inside the projector.
- There are two warning lights—a TEMPERATURE indicator which warns that the projector is too hot, and a LAMP REPLACEMENT indicator which lets you know when to change the bulb.
- If a problem occurs, either the TEMPERATURE indicator or the LAMP REPLACEMENT indicator will light up red, and the power will shut off. After turning off the power, follow the procedures given below.

Warning Indicator	Symptom	Problem	Possible Solution
TEMPERATURE indicator	The internal temperature is abnormally high.	<ul style="list-style-type: none"> <li>• Blocked air intake.</li> <li>• Clogged air filter.</li> </ul>	<ul style="list-style-type: none"> <li>• Relocate projector to a proper location.</li> <li>• Clean the filter. (See page 30.)</li> </ul>
		<ul style="list-style-type: none"> <li>• Cooling fan breakdown.</li> <li>• Internal circuit failure.</li> </ul>	<ul style="list-style-type: none"> <li>• Take the projector to your nearest Authorized Sharp Industrial LCD Products Dealer or Service Center for repair.</li> </ul>
LAMP REPLACEMENT indicator	The lamp does not light up.	<ul style="list-style-type: none"> <li>• Burnt-out lamp.</li> <li>• Lamp circuit failure.</li> </ul>	<ul style="list-style-type: none"> <li>• Carefully replace the lamp.</li> <li>• Take the projector to your nearest Authorized Sharp Industrial LCD Products Dealer or Service Center for repair.</li> </ul>
	The lamp requires replacement.	<ul style="list-style-type: none"> <li>• The lamp has been used for over 1900 hours.</li> </ul>	

### Notes:

- If the TEMPERATURE indicator comes on, solve the problem and then wait until the projector has cooled down completely before turning the power back on. (At least 5 minutes.)
- When the power is turned off and then turned on again, as during a brief rest, the LAMP replacement indicator may be triggered, preventing the power from going on. When this happens, take the power plug out of the AC outlet and put it back in again.

## Before Calling for Service

Problem	Check
No picture and no sound.	<ul style="list-style-type: none"> <li>• The projector AC cord is not plugged into the AC wall outlet.</li> <li>• The main power button is not pressed.</li> <li>• The input is wrong. (See page 22.)</li> <li>• Cables improperly connected to rear panel of the projector. (See pages 14, 15, 16 and 17.)</li> <li>• Remote control batteries have run down. (See page 7.)</li> <li>• The optional cable for the remote control is properly inserted.</li> <li>• The main power of the remote control is not turned on.</li> <li>• The remote control's MOUSE/ADJUSTMENT switch is set to MOUSE.</li> <li>• The usable life of the lamp has been reached. (See page 31.)</li> </ul>
Sound is heard but no picture appears.	<ul style="list-style-type: none"> <li>• Cables improperly connected to rear panel of the projector. (See pages 14, 15, 16 and 17.)</li> <li>• The BRIGHTNESS and PICTURE adjustments are set to minimum position. (See page 23.)</li> </ul>
Color is faded or poor.	<ul style="list-style-type: none"> <li>• The COLOR and TINT adjustments are not correct. (See page 23.)</li> </ul>
Picture is blurred.	<ul style="list-style-type: none"> <li>• Adjust the focus. (See page 9.)</li> <li>• The projection distance is too long or too short to allow for proper focus. (See page 10.)</li> </ul>
Picture appears but no sound is heard.	<ul style="list-style-type: none"> <li>• Cables improperly connected to rear panel of the projector. (See pages 14, 15, 16 and 17.)</li> <li>• Volume is set to minimum. (See pages 22.)</li> </ul>
An unusual sound is occasionally heard from the cabinet.	<ul style="list-style-type: none"> <li>• If the picture is normal, the sound is due to cabinet shrinkage caused by temperature changes. This will not affect operation or performance.</li> </ul>
Maintenance indicator lights up.	<ul style="list-style-type: none"> <li>• Refer to “Lamp/Maintenance Indicators” on page 31.</li> </ul>

# Lamp Replacement

The lamp in the projector has a finite service life. The lamp for this projector has a usable life of 2000 cumulative hours. This number may differ, however, depending on the ambient conditions. The lamp requires replacement in the situations given below.

- When the picture starts becoming dark and the color contrast deteriorates.
- After the lamp has been used for 1900 hours (at this time the LAMP REPLACEMENT indicator will light red and "LAMP" will flash in yellow letters on the screen when the projector is turned on). The lamp usage time can be checked at the On-Screen display. (See page 27.)

**Caution:** Once you are alerted that the lamp requires replacement, be sure to replace the lamp.

Purchase a replacement metal-halide lamp unit (lamp/cage module) of the current type BQC-XGNV1U//1 from your nearest Authorized Sharp Industrial LCD Products Dealer. Then change the lamp by carefully following the instructions below.

If you wish, you may bring the projector to your nearest Authorized Sharp Industrial LCD Products Dealer.

## **IMPORTANT NOTE TO U.S. CUSTOMERS:**

The lamp included with this projector is backed by a 90-day parts and labor limited warranty. All service of this projector under warranty, including lamp replacement, must be obtained through an Authorized Sharp Industrial LCD Products Dealer or Service Center. For the name of the nearest Authorized Sharp Industrial LCD Products Dealer or Service Center, please call toll-free: 1-800-BE-SHARP (1-800-237-4277).

U.S.A. ONLY

## How to Change the Lamp

**Precaution:** Take care not to touch either the lamp in the lamp cage, the inner surface of the reflector mirror, or the mirrors in the optical unit with your bare hands.

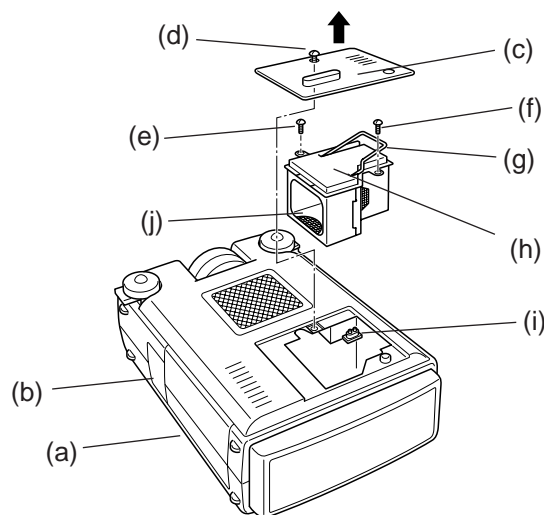

### Removing the lamp unit (see figure)

1. Press the power button (a) and turn the instrument off. After the cooling fan stops, turn off the MAIN POWER switch (b). Remove the power cord from the AC outlet.
2. The lamp may be extremely hot. Wait at least an hour after the power cord is disconnected before carrying out the following procedures.
3. Turn over the projector and unfasten the user service screw (d) that secures the lamp cage cover (c) as shown in the above diagram. Then remove the lamp cage cover by pulling it in the direction of the arrow.

#### **Note:**

When the lamp cage cover (c) has been removed, check that the surface of the lamp cage (h) has fully cooled before proceeding with step 4.

4. After the lamp cage (h) has sufficiently cooled, remove securing screws (e), and (f) from the lamp cage.
5. Hold lamp cage (h) by the handle (g) and pull it towards you.



**Caution:**

Because some parts may not be sufficiently cooled, be sure to remove the lamp cage by the handle while taking care not to touch the metallic areas.

**Note:**

Do not allow anything to hit the UV filter (j).

**Installing the lamp unit**

1. Hold lamp cage (h) by the handle (g) and press it in firmly while making sure that the lamp cage (h) properly connects to the connector (i).
2. Tighten screws (e), (f) and (d), then perform the above instructions in the reverse order.

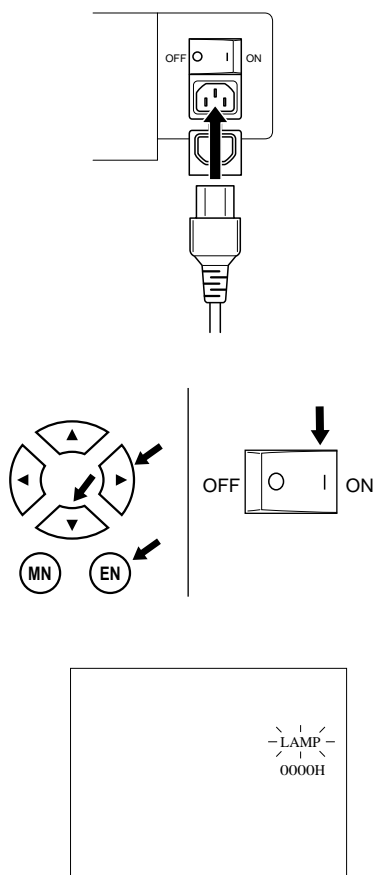
**Resetting the lamp timer**

1. Plug in the power cord.

2. While depressing the ADJUSTMENT ►, ADJUSTMENT ▼, and ENTER buttons on the projector, turn on the MAIN POWER switch.
3. Press the POWER ON/OFF button on the projector or the power on button on the remote control to turn on the power.

After the unit projector turns on, "LAMP 0000H" will be displayed to signify that the lamp timer is reset.

**Notes:**

- After replacing lamp, be sure to reset the lamp timer. If you do not, the LAMP REPLACEMENT indicator and "LAMP" display will not disappear.
- Only reset the lamp timer after replacing the lamp.

# Connection Pin Assignments

## Analog RGB Signal Input and Output Terminal : 15-pin mini D-sub female connector

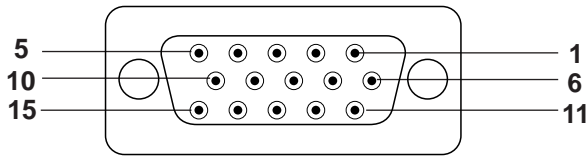

### Computer Input

#### Analog

- |                              |                            |
|------------------------------|----------------------------|
| 1. Video input (red)         | 8. Earth (blue)            |
| 2. Video input (green)       | 9. GND                     |
| 3. Video input (blue)        | 10. GND                    |
| 4. Reserve input 1           | 11. GND                    |
| 5. Composite sync (Mac only) | 12. Reserve input 2        |
| 6. Earth (red)               | 13. Horizontal sync signal |
| 7. Earth (green)             | 14. Vertical sync signal   |
|                              | 15. Reserve input 3        |

## Mouse Input Terminal (for IBM/Mac) : 9-pin D-sub female connector

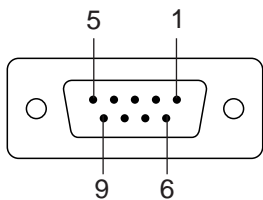

Pin No.	Signal	Name	I/O	Reference
1	CD	Carrier Detect	Input	Connected to internal circuit
2	RD	Receive Data	Input	Connected to internal circuit
3	SD	Send Data	Output	Connected to internal circuit
4	ER	Equipment Ready	Output	Connected to internal circuit
5	SG	Signal Ground		Connected to internal circuit
6	DR	Data Set Ready	Output	Not connected
7	RS	Request to Send	Output	Connected to internal circuit
8	CS	Clear to Send	Input	Connected to internal circuit
9	CI	Ring Indicator	Input	Connected to internal circuit

## Mouse Input Terminal (for NEC PC98 series for Japan) : 9-pin mini DIN connector

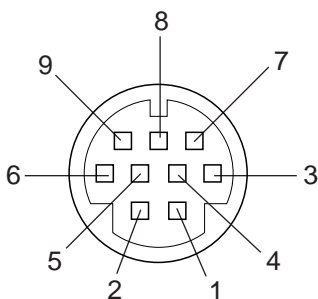

Pin No.	Signal	I/O	Reference
1	+5V	Input	Computer output
2	XA	Input	Computer output
3	XB	Input	Computer output
4	YA	Input	Computer output
5	YB	Input	Computer output
6	LEFT	Input	Computer output
7	NC	Input	Not connected
8	RIGHT	Input	Computer output
9	GND		Computer output

## RS-232C terminal : 9-pin D-sub male connector

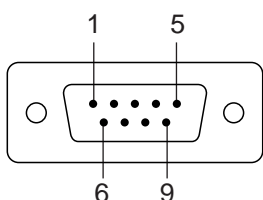

Pin No.	Signal	Name	I/O	Reference
1	CD			Not connected
2	RD	Receive Data	Input	Connected to internal circuit
3	SD	Send Data	Output	Connected to internal circuit
4	ER			Not connected
5	SG	Signal Ground		Connected to internal circuit
6	DR	Data Set Ready	Output	Not connected
7	RS	Request to Send	Output	Connected to internal circuit
8	CS			Not connected
9	CI			Not connected

# RS-232C Terminal Specifications

## 1. PC control

The personal computer can control the projector by connecting the two via an RS-232C cable (not supplied).

## 2. Communication conditions

Set the serial port settings of the computer to match that of the table below.

Signal format: Conforms to RS-232C standard.  
 Baud rate: 9600bps  
 Data length: 8 bits  
 Parity bit: NON  
 Stop bit: 1 bit  
 Flow control: None

## 3. Basic format

Commands from the computer are sent in the following order: command, parameter, and return code. After the unit processes the command from the computer, it sends a response code to the computer.

Command format

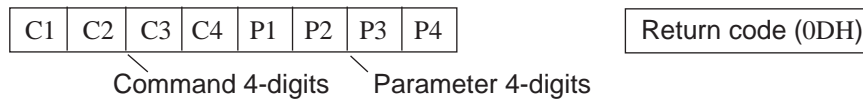

Response code format

Normal response



Problem response (communication error or incorrect command)



When more than one code is being sent, send each command only after the OK response code for the previous command from the unit is verified.

### Note:

Using the computer control function of the unit, the liquid crystal projector conditions cannot be read to the computer. Therefore, confirm the conditions by transmitting the display commands for each adjustment menu and checking the conditions at the On-Screen Display. If the unit receives a command other than a menu display command, it will execute the command without displaying the On-Screen Display.

## 4. Commands

CONTROL ITEM	COMMAND				PARAMETER				CONTROL CONTENTS
	C1	C2	C3	C4	P1	P2	P3	P4	
INPUT SWITCHING	I	V	E	D	-	-	-	1	VIDEO 1
	I	R	G	B	-	-	-	1	RGB 1
LANGUAGE SELECTION	M	E	L	A	-	-	-	1	ENGLISH
					-	-	-	2	DEUTSCH
					-	-	-	3	ESPANOL
					-	-	-	4	NEDERLANDS
					-	-	-	5	SVENSKA
					-	-	-	6	ITALIANO
					-	-	-	7	FRANCAIS
					-	-	-	8	JAPANESE
VIDEO SYSTEM SELECTION	M	E	S	Y	-	-	-	1	AUTO
					-	-	-	2	PAL
					-	-	-	3	SECAM
					-	-	-	4	NTSC
VIDEO IMAGE ADJUSTMENT	V	A	P	I	-	*	*	*	PICTURE (-30 ~ +30)
	V	A	B	R	-	*	*	*	BRIGHT (-30 ~ +30)
	V	A	C	O	-	*	*	*	COLOR (-30 ~ +30)
	V	A	T	I	-	*	*	*	TINT (-30 ~ +30)
	V	A	S	H	-	-	-	*	SHARPNESS (0 ~ 3)
	V	A	R	E	-	-	-	0	VIDEO
					-	-	-	1	RESET

### Note:

If a dash appears in the parameter column enter a space. If an asterisk appears enter a value in the range indicated in brackets under CONTROL CONTENTS. See the example on the next page.

# RS-232C Terminal Specifications

CONTROL ITEM	COMMAND				PARAMETER				CONTROL CONTENTS
	C1	C2	C3	C4	P1	P2	P3	P4	
VOLUME ADJUSTMENT	V	O	L	A	-	-	*	*	VOLUME (0 ~ 60)
	M	U	T	E	-	-	-	0	MUTE OFF
					-	-	-	1	MUTE ON
AUDIO ADJUSTMENT	A	A	B	L	-	*	*	*	BALANCE (-30 ~ +30)
	A	A	T	E	-	*	*	*	TREBLE (-30 ~ +30)
	A	A	B	A	-	*	*	*	BASS (-30 ~ +30)
	S	R	S	M	-	-	-	0	SRS OFF
					-	-	-	1	SRS MODE1
					-	-	-	2	SRS MODE2
					-	-	-	3	SRS MODE3
					-	-	-	4	SRS MODE4
					-	-	-	5	3D MONO
	A	A	R	E	-	-	-	0	AUDIO DISPLAY
				-	-	-	1	RESET	
RGB ADJUSTMENT	R	A	P	I	-	*	*	*	PICTURE (-30 ~ +30)
	R	A	B	R	-	*	*	*	BRIGHT (-30 ~ +30)
	R	A	R	D	-	*	*	*	RED (-30 ~ +30)
	R	A	B	E	-	*	*	*	BLUE (-30 ~ +30)
	R	A	R	E	-	-	-	0	RGB DISPLAY
					-	-	-	1	RESET
RGB INPUT ADJUSTMENT	I	N	C	L	-	*	*	*	CLOCK (-60 ~ +60)
	I	N	P	H	-	*	*	*	PHASE (-60 ~ +60)
	I	A	H	P	-	*	*	*	HPOS (-60 ~ +60)
	I	A	V	P	-	*	*	*	VPOS (-30 ~ +30)
	I	A	R	E	-	-	-	0	RGB INPUT DISPLAY
					-	-	-	1	RESET
SCREEN SETTING	I	M	E	Z	-	-	-	0	E-ZOOM OFF
					-	-	-	1	E-ZOOM ON
	I	M	B	E	-	-	-	0	BLUE SCREEN OFF
					-	-	-	1	BLUE SCREEN ON
	I	M	B	K	-	-	-	0	BLACK SCREEN OFF
					-	-	-	1	BLACK SCREEN ON
	I	M	D	I	-	-	-	0	INPUT DISPLAY OFF
					-	-	-	1	INPUT DISPLAY ON
	I	M	R	E	-	-	-	0	REVERSE OFF
					-	-	-	1	REVERSE ON
I	M	I	N	-	-	-	0	INVERT OFF	
				-	-	-	1	INVERT ON	
VIDEO CONFIRMATION	S	Y	S	E	-	-	-	0	DISPLAY
MOUSE ADJUSTMENT	R	E	M	O	-	-	-	1	REMOTE MOUSE AT
					-	-	-	2	REMOTE MOUSE 98
SCREEN MODE MEMORY	M	E	M	A	-	-	-	0	MEMORY RELEASE
					-	-	-	*	MEMORY SELECTION (1 ~ 7)

**Note:**  
Power ON/OFF cannot be controlled from the RS-232C terminal. Use the wired remote control input to control power ON/OFF.

## Examples:

For the RGB/VIDEO setting, select video and set the PAL mode.

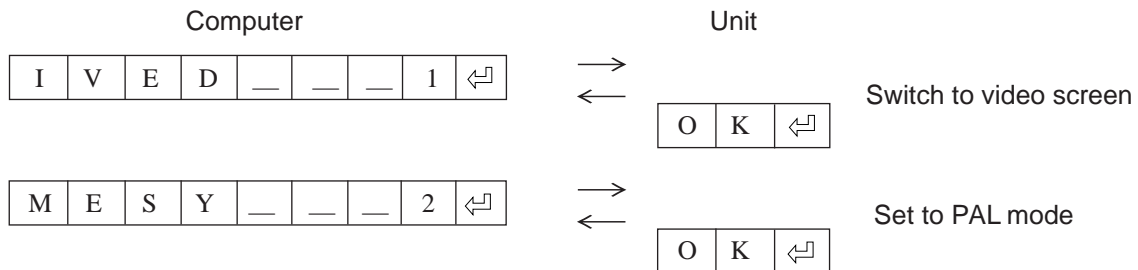

When BRIGHT of VIDEO IMAGE ADJUSTMENT is set to -10.

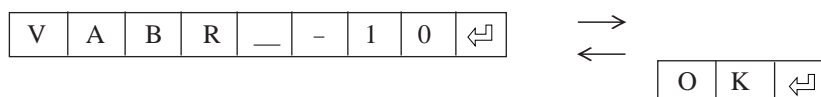

# Specifications

Product Type	LCD Projector
Model	PG-D100U
Video system	PAL/SECAM/NTSC 3.58
Display method	LCD panel × 3, RGB optical shutter method
LCD panel	Panel size: 1.3" (19.8 [H] × 26.4 [W] mm) Display method: Translucent TN liquid crystal panel Drive method: TFT (Thin Film Transistor) Active Matrix panel No. of dots: 519,168 dots (832 [H] × 624 [V])
Lens	F2.8 to 3.3, f = 53 to 74 mm
Projection lamp	265 W Metal halide
Contrast ratio	100:1
Video input signal	RCA Connector: VIDEO, composite video, 1 Vp-p, sync negative, 75 Ω terminal RCA Connector: AUDIO, 0.5 Vrms less than 22 kΩ
S-video input signal	4-pin mini DIN connector Y (luminance signal): 1 Vp-p, sync negative, 75 Ω terminated C (chrominance signal): Burst 0.286 Vp-p, 75 Ω terminated
Video output signal	RCA Connector: AUDIO, 0.5 Vrms less than 2.2 kΩ
Horizontal resolution	580 TV lines (video input)
Audio output	3 W + 3 W (Stereo)
Computer RGB input signal	Video Signal: 15-pin mini D-sub connector: RGB separate type analog input: 0.7 Vp-p, positive, 75 Ω terminated Stereo Minijack: AUDIO, 0.5 Vrms, more than 22 kΩ (stereo) Horizontal sync. signal: TTL level (positive/negative) or composite sync (Apple only) Vertical sync. signal: Same as above
RS-232C input terminal	9-pin D-sub male connector for controlling personal computer
Mouse input terminal (for IBM/Mac)	9-pin D-sub female connector for wireless mouse
Mouse input terminal (for PC98)	9-pin mini DIN connector for wireless mouse
Speaker system	3" (8 cm) round × 2
Rated voltage	AC 120 V
Rated frequency	50/60 Hz
Power consumption	355 W
Operating temperature	41°F to 104°F (5°C to 40°C)
Storage temperature	-4°F to 132°F (-20°C to 60°C)
Cabinet	Plastic
Laser Pointer of Remote Control	Wave length : 670nm Max. output : 1mW Class II Laser Product
Dimensions (W × D × H)	10 <sup>25</sup> / <sub>64</sub> " × 15 <sup>9</sup> / <sub>32</sub> " × 4 <sup>23</sup> / <sub>32</sub> " (264 × 388 × 120 mm)
Weight	16.5 lbs. (7.5 kg)
Supplied accessories	Remote control unit, Four AA batteries, Extra air filter, RGB signal cable (9.8', 3 m), Macintosh adaptor, Mouse control cable for IBM (5.9", 15cm), Mouse control cable for Mac (5.9", 15cm), Mouse control cable (9.8', 3m), AC cord, Lens cover (installed)
Replacement parts	Lamp unit (Lamp/cage module) (BQC-XGNV1U//1), Remote control (RRMCG 1327CESA), Air filter (PFILD0051CEZZ), VGA cable (QCNW-4422CEZZ), Macintosh adaptor (QPLGJ1510CEZZ), Mouse control cable for IBM PS/2 (QCNW-4754CEZZ), Mouse control cable for Mac (QCNW-4755CEZZ), Mouse control cable (QCNW-4620CEZZ), AC cord (QACCU5013CEZZ)

Our projector uses LCD (Liquid Crystal Display) panels. These very sophisticated panels contain 519,168 pixels (× RGB) TFTs (Thin Film Transistors). As with any high technology electronic equipment such as large screen TVs, video systems and/or video cameras, there are certain acceptable tolerances that the equipment must conform to. Sharp's acceptable tolerances permit a total of 6 inactive TFTs, which may result in illuminated or inactive dots on the picture screen.

This will not affect the picture quality or the life expectancy of the unit.

If you have any questions about this matter, please call toll free 1-800-BE-SHARP (1-800-237-4277).

U.S.A. ONLY

# Dimensions

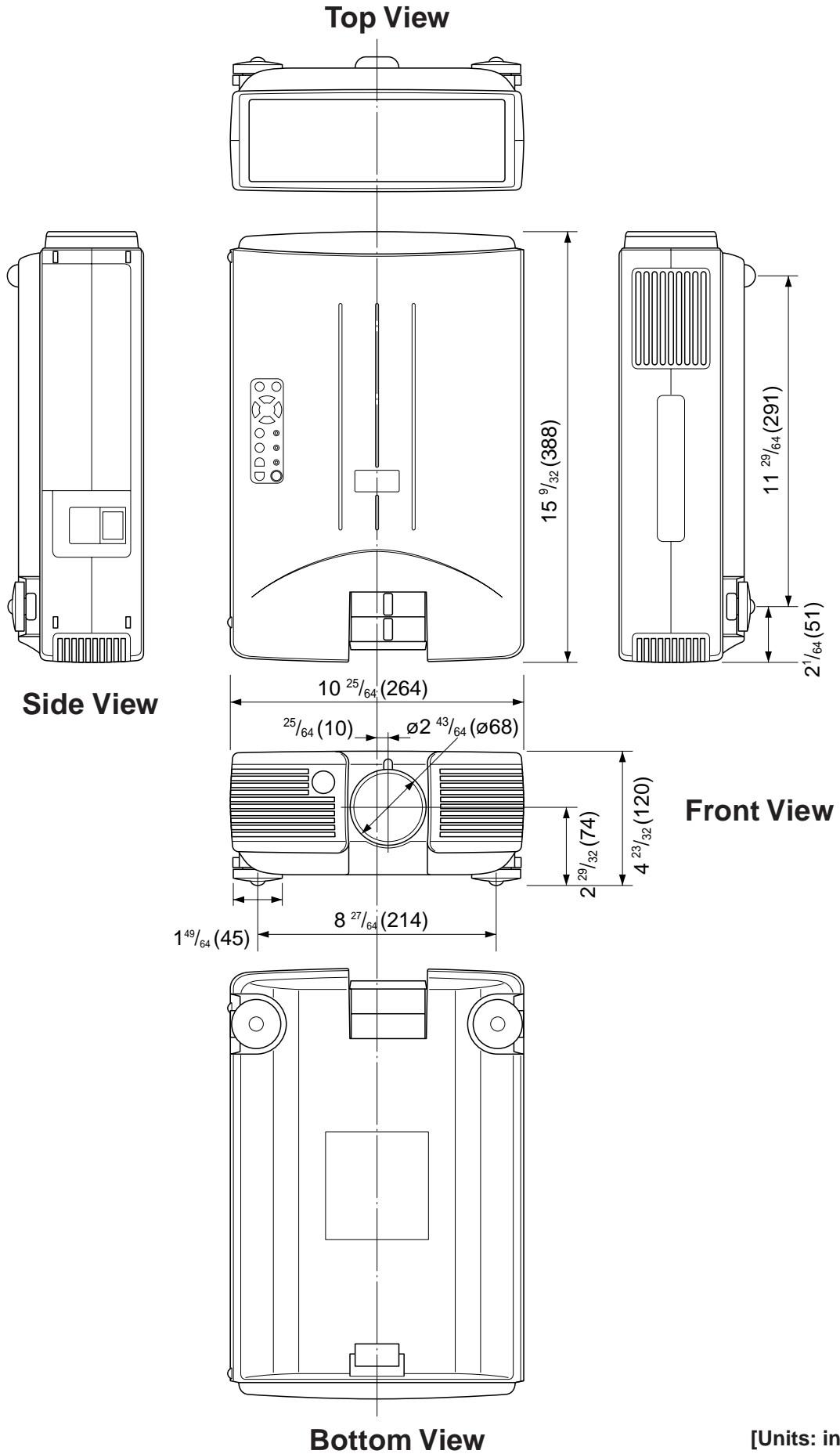

[Units: inches (mm)]