

SHARP[®]

User's Manual

(Touch Panel Operation)

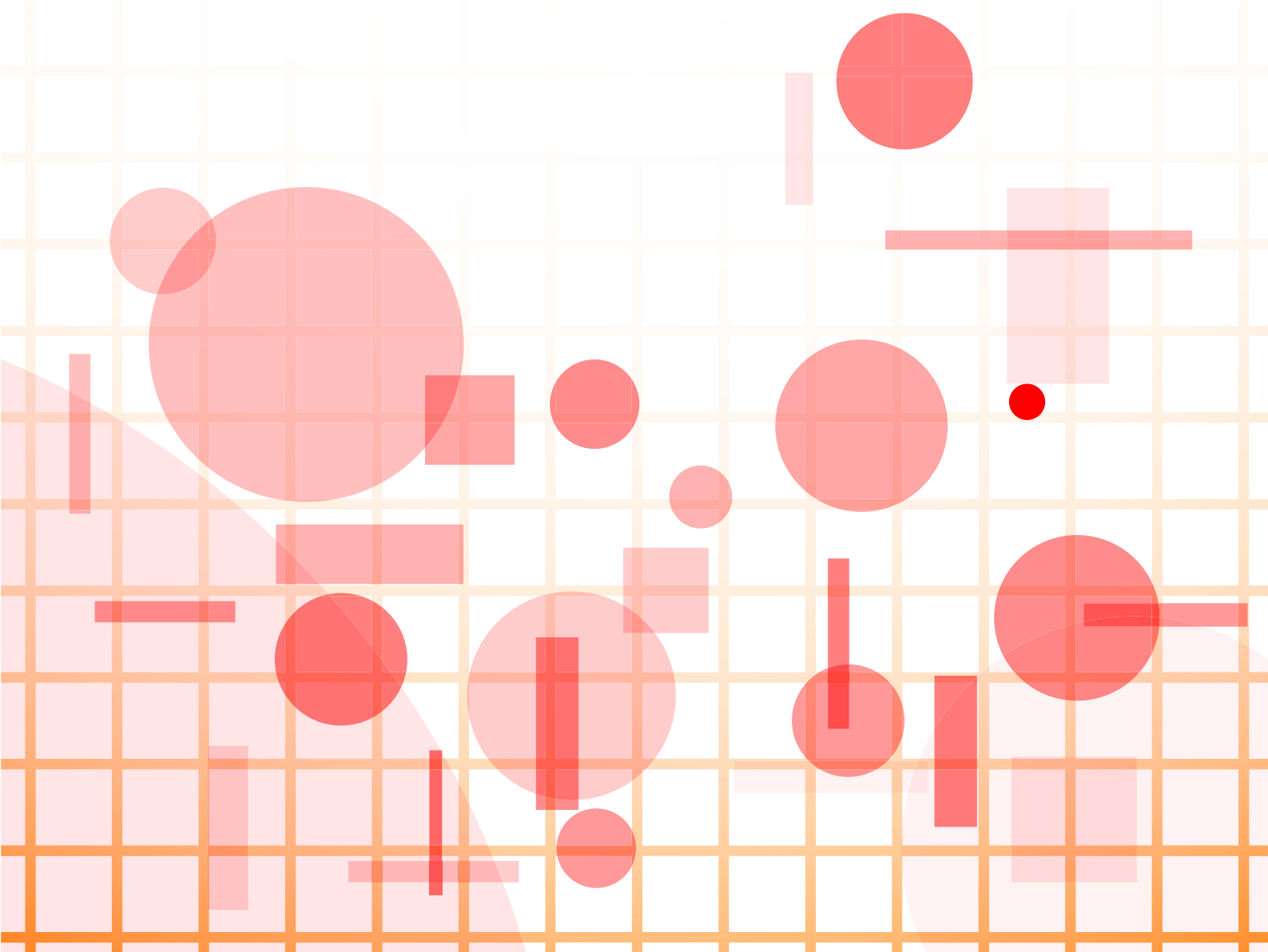

TABLE OF CONTENTS

ABOUT THIS GUIDE	3
TOUCH PANEL	4
• TOUCH TYPES	4
• HOME SCREEN	8
• OPERATION OF FREQUENTLY USED KEYS	12
• ACTION PANEL	13
• CONFIRMATION SCREEN FOR FAVORITE MENUS AND SETTINGS	13
STOPPING/DELETING A JOB, PRIORITY PROCESSING AND CHECKING THE STATUS	16
• TYPES OF JOB STATUS SCREENS	16
• STOPPING/DELETING A JOB IN PROGRESS OR RESERVED	18
• PRIORITY PROCESSING OF A RESERVED JOB	19
• CHECKING A RESERVED JOB OR THE JOB IN PROGRESS	21
• CHECKING COMPLETED JOBS	22
• READING THE JOB LIST	23
CUSTOMIZING THE DISPLAY (U/I Customize)	26
• ITEMS YOU CAN CUSTOMIZE	27
• GENERAL PROCEDURE FOR USING U/I CUSTOMIZE	29
EDITING SHORTCUT KEYS	32
• ADDING SHORTCUT KEYS	32
• DELETING A SHORTCUT KEY	35
• CHANGING A SHORTCUT KEY	37
• ADDING A SHORTCUT KEY IMAGE	40
• MOVING A SHORTCUT KEY	42
• RETURNING THE SHORTCUT KEYS TO THE FACTORY DEFAULT STATE	44
EDITING THE HOME SCREEN	46
• CHANGING THE LAYOUT PATTERN OF THE HOME SCREEN	46
• SELECTING A MFP DISPLAY PATTERN FOR THE HOME SCREEN	48
• CHANGING THE COLOR OF TEXT ON THE HOME SCREEN	49
• CHANGING THE BACKGROUND IMAGE OF THE HOME SCREEN	50
• CHANGING THE FIXED KEYS	53
• INCREASING THE TEXT SIZE	55
• CHANGING THE LANGUAGE USED ON THE MACHINE	56
CHARACTER ENTRY	57
• NAMES AND FUNCTIONS OF SOFT KEYBOARD KEYS	57
• SET THE KEYBOARD SETTING	58

ABOUT THIS GUIDE

This guide explains how to operate the touch panel and customize the user interface.

Please note

- Wherever "xx-xxxxx" appears in this guide, please substitute your model name for "xx-xxxxx".
- This guide does not provide detailed explanations of the functions of the machine. For detailed information on the names and functions that appear in this guide, see the User's Manual.
- Considerable care has been taken in preparing this manual. If you have any comments or concerns about the manual, please contact your dealer or nearest authorized service representative.
- This product has undergone strict quality control and inspection procedures. In the unlikely event that a defect or other problem is discovered, please contact your dealer or nearest authorized service representative.
- Aside from instances provided for by law, SHARP is not responsible for failures occurring during the use of the product or its options, or failures due to incorrect operation of the product and its options, or other failures, or for any damage that occurs due to use of the product.

Warning

- Reproduction, adaptation or translation of the contents of the manual without prior written permission is prohibited, except as allowed under copyright laws.
- All information in this manual is subject to change without notice.

Illustrations, operation panel, touch panel, and Web pages in this guide

The peripheral devices are generally optional, however, some models include certain peripheral devices as standard equipment. For some functions and procedures, the explanations assume that devices other than the above are installed.

Depending on the content, and depending on the model and what peripheral devices are installed, this may not be usable. For details, refer to the User's Manual.

The explanations in this manual are based on American English and the North American version of the software.

Software for other countries and regions may vary slightly from the North American version.

- The display screens, messages, and key names shown in the manual may differ from those on the actual machine due to product improvements and modifications.
- The touch panel, illustrations, and setting screens in this manual are for reference only, and may vary by model, installed options, settings changed from the default state, and country or region.
- Details of system settings as well as settings methods may differ depending on the model.
- This manual assumes that a full-color machine is being used. Some of the explanations may not apply to a monochrome machine.

TOUCH PANEL

TOUCH TYPES

In addition to tapping, equivalent to conventional touching, the touch panel of the machine can be operated by long touching, flicking and sliding.

Operation types

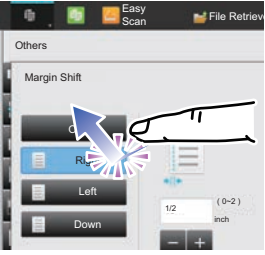
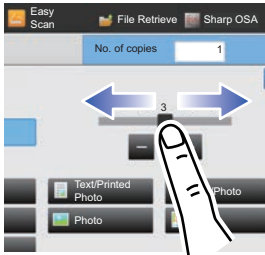
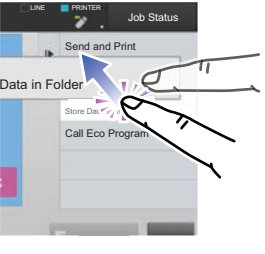
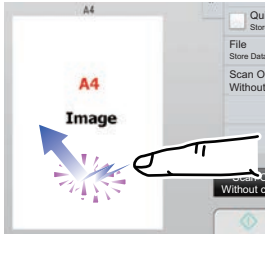
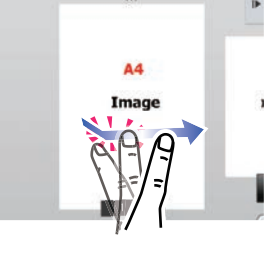
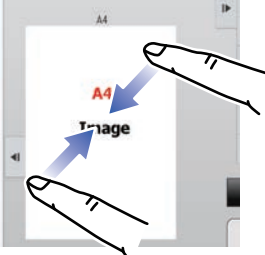
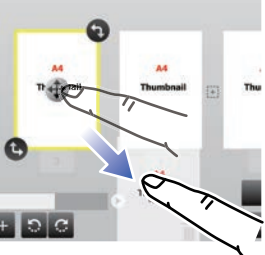
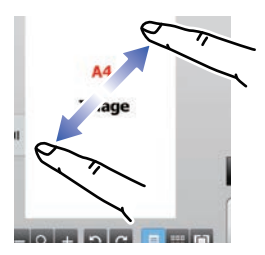
	<p>Tapping Touch the panel with your finger and then lift it quickly. Use this method to select a key, tab or check box.</p>		<p>Sliding Slide the scroll bar (with your finger touching the panel) to scroll up and down a list with a large number of items.</p>
	<p>Long touching Touch the panel with your finger and hold it for a while. Keep holding (long touching) it on the action panel or characters in the text box to display characters in a balloon.</p>		<p>Double tapping Touch the screen twice. Use this operation to enlarge the image in the preview.</p>
	<p>Flicking Flick the panel to scroll a preview image quickly.</p>		<p>Pinch Touch the screen with two fingers and move them toward each other. This is used to reduce the browser and preview display.</p>
	<p>Dragging Drag (slide your finger touching the panel in a random direction) to replace a page in the original during preview.</p>		<p>Spread Touch the screen with two fingers and move them away from each other. This is used to enlarge the browser and preview display.</p>

Operation on respective screens

Key (tapping)

- A. Tap to select an item. The selected key turns into a different color.
- B. Tap numeric keys to enter numbers.
- C. Tap to increase or decrease the value. Long touching causes the value to be increased or decreased until you stop touching.
- D. Tap to enter a checkmark and enable the setting.
- E. Tap here to close the screen.

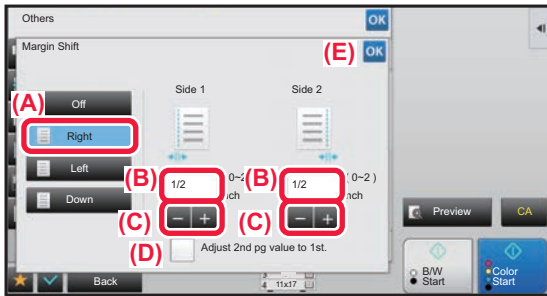

List (tapping, sliding and flicking)

- A. Tap to select an item. The selected item turns into a different color.
- B. Slide the bar up and down. It appears when the item does not fit in the screen.
- C. Flick the key upwards or downwards. The item scrolls up or down.



Slider (sliding)

- A. Slide the knob from side to side.

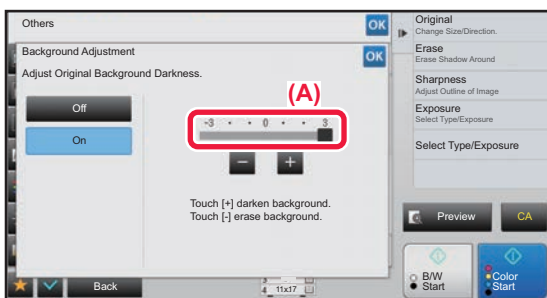

Touch Panel Operation

Tab (tapping)

A. Tap a tab to switch what is displayed.

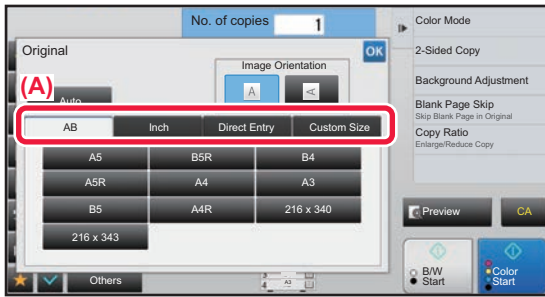

Preview screen (Double tapping/ Pinch/ Spread)

A. When a preview screen is "pinched", the screen image is reduced. When "spread", the image is enlarged. When "Double tapping", the image is also enlarged.

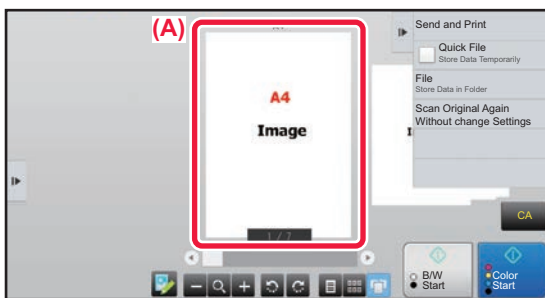

TAP OPERATION SETTINGS

You can configure settings for tap operation on the touch panel in "Settings (administrator)" – [System Settings] → [Common Settings] → [Operation Settings] → [Condition Settings] → [Key Operation Setting].

Key Operation Setting

Auto Clear Setting

The time until Auto Clear activates can be set to any number of seconds from 10 to 240 in increments of 10 seconds. If the machine is not used for the duration of time set here, the auto clear function will clear any settings that have been selected and return the screen to the base screen of copy mode or the job status screen.

Cancel Timer

This is used to disable the auto clear function.

Key Operation Setting

• Time for Accepting Key Entry

This setting determines how long a key in the touch panel must be tapped until the key input is registered. The time can be set from 0 to 2 seconds in increments of 0.5 seconds.

By lengthening the time setting, key input can be prevented when a key is tapped accidentally. Keep in mind, however, that when a longer setting is selected more care is required when tapping keys to ensure that key input is registered.

• Disable Auto Key Repeat

This is used to disable key repeat.

Key repeat causes a setting to change continuously not only each time the key is tapped but while a key is tapped.

Time for Accepting Key Entry of Long Touch

Select a time when a long key touch is detected.

Double Tap Interval Setting

Select an interval when a double tap is detected.

Keys Touch Sound

You can configure settings for keys touch sound in "Settings (administrator)" – [System Settings] → [Common Settings] → [Sound Settings] → [Beep Sound Settings (Common)].

Keys Touch Sound

Controls the key touch sound level, or turns the sound off.

Make Key Touch Sound at Default Setting

When you specify the exposure in the exposure adjustment screen of each mode, a beep sounds three times when the reference value is reached.

Screen in which setting is effective	Initial value
Ratio setting screen in base screen of copy mode	Ratio 100%
Exposure setting screen in base screen of copy mode	Exposure level: 3 (medium)
Exposure adjustment screen in base screen of fax, Internet fax, and network scanner modes	
Exposure adjustment screen for Scan to Local Drive in document filing mode	

HOME SCREEN

Pressing the [Home Screen] key on the operation panel displays the home screen on the touch panel. The home screen displays the keys for selecting modes or functions.

The screenshot shows the touch panel home screen with several elements highlighted by red boxes and lines pointing to explanatory text:

- Top status bar:** Contains icons for 'Easy Copy', 'Easy Scan', 'File Retrieve', and 'Sharp OSA'. A red box highlights this area with the text: "Displays the machine's status other than the job using icons." and a link: "▶ [Icon indicating the status of the machine \(page 9\)](#)".
- Time display:** Shows '10:15 AM'. A red box highlights this area with the text: "Displays the time.".
- Job status:** Shows 'Job Status'. A red box highlights this area with the text: "Displays the job in progress or waiting with text or icon.".
- Mode selection:** A red box highlights the top bar with the text: "Tap a mode to change to that mode." and a link: "▶ [Changing mode from the mode display \(page 11\)](#)".
- Shortcut keys:** A red box highlights the main area with icons for 'CLOUD PORTAL', 'Easy Copy', 'Easy Scan', and 'Easy Fax'. A red box highlights the bottom bar with the text: "Select functions that can be utilized in respective modes. Tap the tab, and the list of function keys is displayed." and a link: "▶ [ACTION PANEL \(page 13\)](#)".
- Page switching:** A red box highlights the bottom bar with the text: "Switch the pages for displaying shortcut keys.".
- Bottom bar:** A red box highlights the bottom bar with the text: "Use these keys to select functions that make the machine easier to use.".

For procedures for adding and deleting shortcut keys, see "[General procedure when using the touch panel \(page 29\)](#)".



- **To set the home screen for each "Favorite Operation Group List":**

In "Settings (administrator)", select [User Control] → [Access Control Settings] → [Favorite Operation Group] → [Home Screen List].

Perform this setting when user authentication is used.



























- **To display the External Service Connect shortcut keys:**

You can add shortcut keys for the External Service Connect functions (Google Drive, OneDrive, SharePoint Online, Gmail, Exchange (E-Mail)) to the home screen.

These functions can be enabled in the system settings. When a function is enabled in the system settings, you can add a shortcut key for that function to the home screen.

For details, refer to the "Cloud Connect Guide".

Icon indicating the status of the machine

Icon	Machine status	Icon	Machine status
	Printer data is being processed.		A USB device is installed.
	Printer data is being printed.		The field support system is enabled.
	Send data exists.		Single-byte alphanumeric character entry
	Forward error data exists.		A data security kit is installed.
	Received data exists.		Connecting to the access point (Level 4)
	Received confidential fax data exists.		Connecting to the access point (Level 3)
	Received data is held.		Connecting to the access point (Level 2)
	Received preview data exists.		Connecting to the access point (Level 1)
	OSA communication is in progress.		Not connected to the access point
	Enlarge display mode is enabled.		Bad connection of the wireless LAN device in the machine*
	Eco mode is enabled.		Waiting for the access point
	A maintenance notification is issued.		A LAN cable is not connected.
	Remote operation is in progress.		Image job log file persistence status

* Contact your dealer or nearest authorized service representative.

Screen Display Settings

You can configure settings for tap operation on the touch panel in "Settings (administrator)" – [System Settings] → [Common Settings] → [Operation Settings] → [Condition Settings] → [Screen Display Settings].

Enlarge Display Mode

Displays large characters on the screen.

 appears in the system area when Large Character Mode is enabled.

Message Time Setting

The duration of time that messages appear in the touch panel (the time until a message is automatically cleared) can be set to any number of seconds from 1 to 12.

Language Setting

The language that appears in the touch panel can be changed to any language.



When user authentication is enabled and a display language is specified in the favorite operation group, that setting is given priority.

Default Display Setting

Set the screen that appears after auto clear and login.

Display Favorite Menus as Default

You can specify to display the "Favorite" first during mode selection.

Display Action Panel as default.

Specify whether or not to display with the action panel on the screen.

Icon is displayed when LAN cable is not connected.

Show an icon when a LAN cable is not connected.

Display Confirmation Dialog when job is canceled.

Show a confirmation dialog box when a job is canceled.

Display Status Notification Message

Set whether to display a notification message when a job is completed.

Restrict Total Count display

When this setting is enabled, the total count is hidden when checking the total count from the home screen.

Switch the Number of Sets to be Displayed for Job Status

Set whether the remaining number of sets or the final number of sets is shown in the job status.

Display the estimated job start time

Specify whether or not to display the estimated start time of the job in the job status.

Alignment Order of 10-Key

Set whether the numeric keys are arranged in ascending order with "1" in the upper left corner, or "1" in the lower left corner.

Setting Display from Main Unit

Select settings for the path information of the setting destination displayed when setting mode is set on the machine.

Display Current Path

Set whether or not the current setting items are shown in the path information.

Enable link of current path

Set whether the link at the top is enabled.

MFP Display Pattern Setting

Set the background color of the touch panel. Each time you change patterns, the touch panel image at the bottom of the screen changes.

CHANGING MODES

Changing mode from the Home screen

Press the [Home Screen] key.

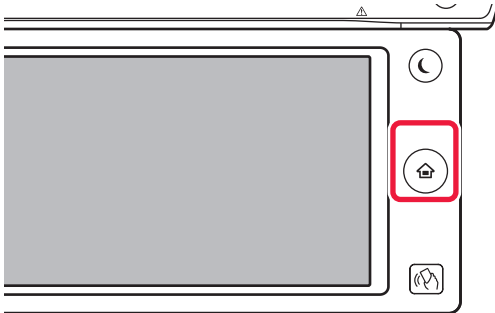

Tap the mode icon.



Changing mode from the mode display

Tap on the mode display.

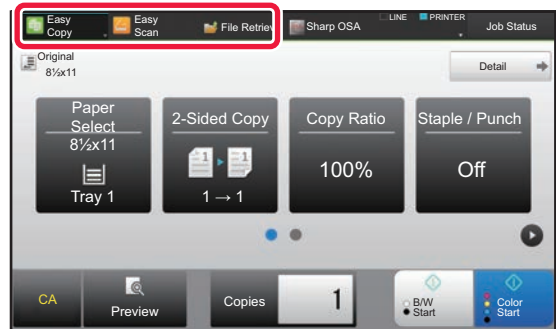

Tap the key that shows ▾.

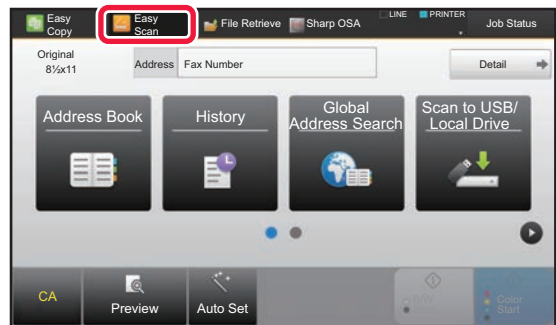

Tap for any mode desired.

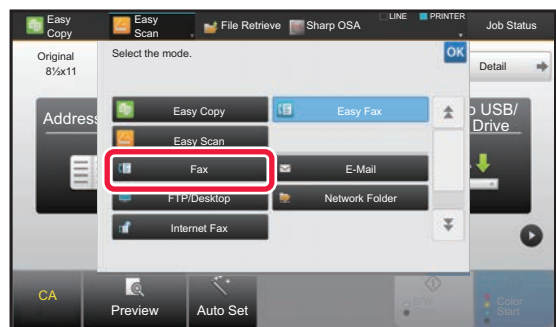

For procedures for editing the home screen, see "[EDITING THE HOME SCREEN \(page 46\)](#)".



• Mode Key Display Setting

In "Settings (administrator)", select [System Settings] → [Common Settings] → [Operation Settings] → [Mode Key Display Setting].

Configure settings for the display of mode keys at the top of the screen.

• Modes to Display

Select the mode keys that you want to display.

• Display Mode Keys on Home

You can enable display of the mode keys in the home screen as well.

OPERATION OF FREQUENTLY USED KEYS

Numeric keys

Tap a number to enter it.

To clear the entered number, tap the [C] key.

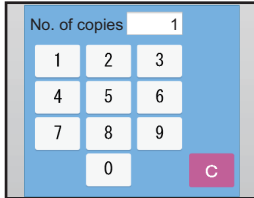

On the address screen, you can enter characters other than numbers, and a different key layout is provided. You can also move the cursor by using the [←] and [→] keys. Tap the [C] key to delete one character to the left of the cursor.

[Start] key ([B/W Start] key and [Color Start] key)

Tap to perform a print or send job.



In copy mode, [B/W Start] and [Color Start] keys are displayed.

[Cancel Copy] key, [Storing Canceled] key, [Cancel Scan] key, [Sending Canceled] key

Tap to stop copying, printing, or transmission.

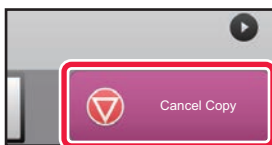

[CA] key



Tap to cancel all settings and restore the initial status in each mode.



ACTION PANEL

Recommended functions are displayed on the action panel when you configure functions in each mode.

From the action panel, you can configure functions or combine the configured function with a function displayed on the action panel.

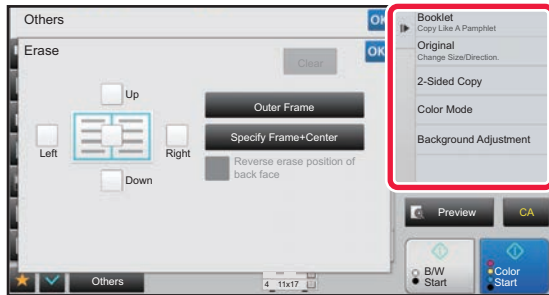
If the action panel does not appear, tap the action panel tab.



- The functions displayed on the action panel vary depending on the mode or the functions that have been configured.
- If too many functions have been configured to be displayed on the action panel, you can slide the panel vertically or tap  and  to view all.
- In enlarge display mode, part of the text on the action panel may not be displayed. To display the whole text, long-touch the partially hidden key or slide the tab of the action panel to the left.



To always display the action panel

In "Settings (administrator)", select [System Settings] → [Common Settings] → [Operation Settings] → [Condition Settings] → [Display Action Panel as default.].

CONFIRMATION SCREEN FOR FAVORITE MENUS AND SETTINGS

When you register frequently used functions you have configured for copying or image sending in favorite, you can quickly call them.



Favorite can be used in normal mode.

Favorite Key Setting

This setting can only be set on web pages.

In "Settings (administrator)", select [System Settings] → [Common Settings] → [Operation Settings] → [Favorite Key Setting].

Set the information that appears when favorite keys are tapped in normal mode.

Click the Copy, Scan, Internet Fax, Fax, and Data Entry tabs to configure settings for the favorite key screens shown in each of the normal modes.

Favorite Key Number

Sets the favorite key number.

The items appear will appear in order on the screen starting from the item that is set in No. 1.

Key Name

Enter a maximum of 20 characters for the favorite key name.

Function Menu

To set functions such as "Other Functions", select the functions from the pull-down menu.

Job Programs

To set a program, select one of the preset programs from the program list.

Not Display

You can hide a set key in the favorite key screen.

Registering a function in Favorite

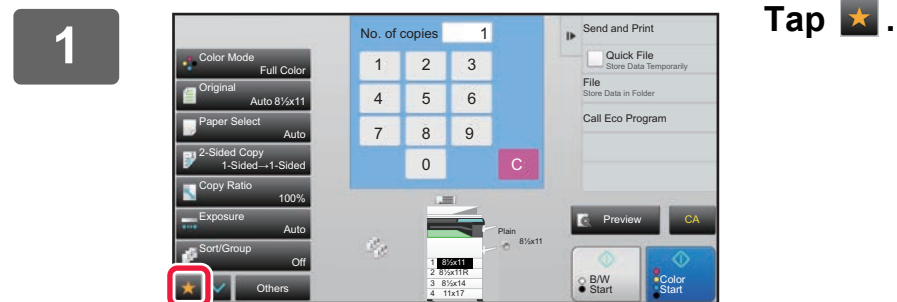

2 Tap [Edit Favorite] on the action panel.

3 Tap the [Register Key] key.
Administrator rights are required.

4 Tap the key for the function you want to register.

Calling a function from Favorite

1

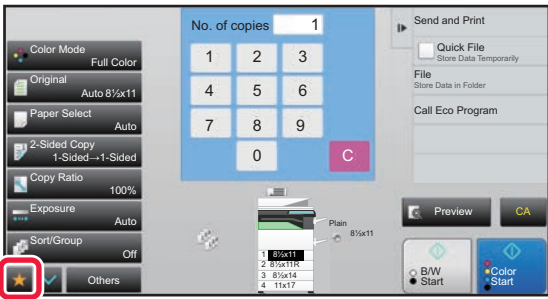

Tap  .

2

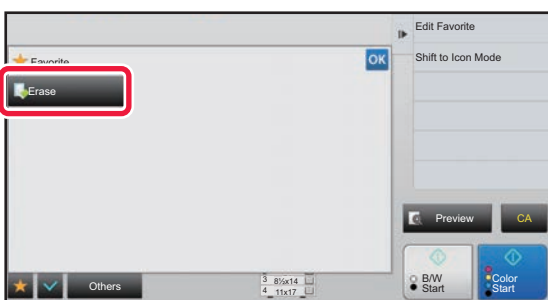

Tap the key for the function you want to call.



- Favorites can be registered or edited only by authenticated users and administrators.
- Unauthenticated users can call and use the favorites registered by administrators. Settings for calling Favorites and permitting/prohibiting editing can be configured in [User Control] → [Access Control Settings] → [Authority Group] in "Settings (administrator)".
- To edit favorites, tap  and then tap [Edit Favorite] on the action panel.

Confirmation Screen for Settings

You can display a list of configured functions and check them.

On the initial screen of each mode, tapping  displays the setting confirmation screen.

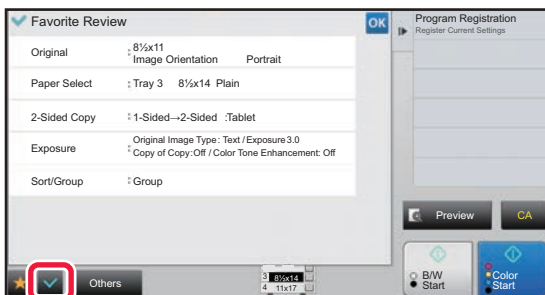

Program Registration
Register Current Settings

Original	: 8½x11	Image Orientation	: Portrait
Paper Select	: Tray 3	8½x14	Plain
2-Sided Copy	: 1-Sided→2-Sided	Tablet	
Exposure	Original Image Type: Text / Exposure 3.0 Copy of Copy: Off / Color Tone Enhancement: Off		
Sort/Group	: Group		

Preview CA

B/W Start Color Start

STOPPING/DELETING A JOB, PRIORITY PROCESSING AND CHECKING THE STATUS

TYPES OF JOB STATUS SCREENS

When you tap the job status display, the job status screen appears. Tap it again to return to the previous mode. The job status screen is divided into the following four tabs, enabling you to select a job list by tapping a desired tab.



• Print

Lists print jobs such as copying, printing from a PC, USB direct print, and printing for faxed or other received data.

• Scan

Lists send jobs of converted images for e-mail messages and FTP/Desktop send jobs.

• Fax

Lists fax send jobs using a telephone line.

• Internet Fax

Lists fax send jobs using internet.



The background of the job status display changes as follows:

- Green: Job in progress
- Yellow: Warming up/waiting
- Red: Waiting for error clearing



• To prohibit the display and changing of job information of other users when user authentication is enabled
 Select "Settings (administrator)" → [System Settings] → [Common Settings] → [Default Settings] → [Include Job Status in user authentication] → [Disable display/change of other users' information in the job status] check box to .

• Job Spool Queuing

When this function is enabled, received print jobs are displayed in the spool queue of the job status screen. The jobs are moved to the job queue after they have been analyzed by the machine. Multiple jobs that have not yet been analyzed appear in the spool queue.

In "Settings (administrator)", select [System Settings] → [Printer Settings] → [Condition Settings] → [Job Spool Queuing].

On each tab, jobs are classified into three groups.

Jobs move among the lists according to the processing status, from [Spool], [Job Queue] and [Complete], in that order.

To switch the job list display to the display by processing status, tap the [Spool], [Job Queue] or [Complete] key as desired.

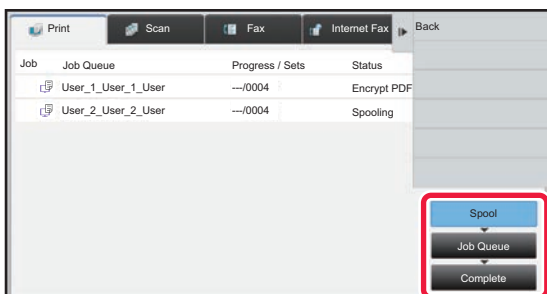

- **Spool list (Only displayed when a print-from computer job is received)**

Lists print jobs up to the transfer to the machine from a computer. The jobs move to the Job Queue list after the transfer is completed.

If you printed an encrypted PDF file by direct print, enter the password from here to print the file.

- **Job Queue list**

Lists jobs in progress and in the queue for copying, printing from a computer and printing of received fax. This list also displays jobs in progress and in the queue for sending fax data or sending image data converted on the machine. The jobs move to the Complete list after printing or sending is completed.

- **Complete list**

Lists jobs through with copying, printing or sending.

STOPPING/DELETING A JOB IN PROGRESS OR RESERVED

- 1 Tap the job status display and tap the tab for the job that you wish to stop or delete.

2



Tap the [Job Queue] key.



When you wish to stop a print job being sent from the computer, tap the [Spool] key.

3

Tap the job that you wish to stop or delete, and then tap [Stop/Delete] on the action panel.

When a screen appears that allows you to confirm that you do want to stop the job, tap the [Cancel] key.



If the machine runs out of paper during a copy or print job, you can cancel the job from the job status screen. To delete more than one job, operate the check box for [Enter Multi Selection Mode] on the action panel so that it looks like .



- Printing of a received fax or Internet fax cannot be stopped.
- A job set for transfer cannot be canceled.

PRIORITY PROCESSING OF A RESERVED JOB

This function gives priority to processing of copied, faxed or image send jobs arising later to jobs already in a queue for printing or sending.



Priority processing operation varies, as follows, depending on the job type.

- Job on the print tab
The job currently in progress is suspended to let the priority job make interruption.
- Job on the scanner/fax/Internet fax tab
The priority job is moved directly under the job currently in progress.

1

Tap the job status display and tap the job for priority processing.

2

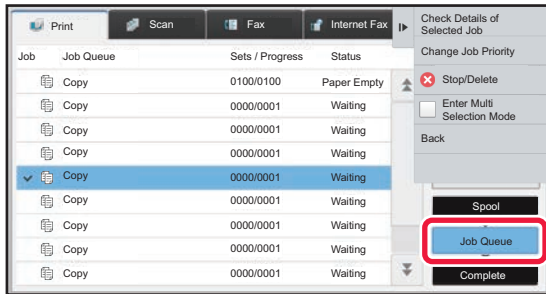

Tap the [Job Queue] key.

3

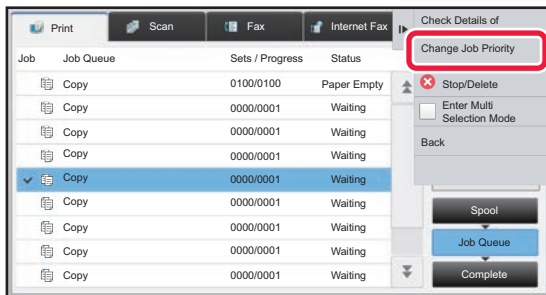



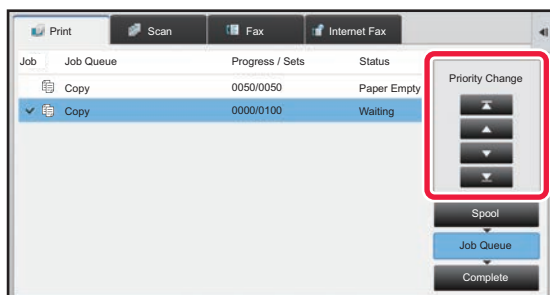

Tap the job for priority processing and then tap [Change Job Priority] on the action panel.

Changing the job order





If there is a job in progress, an interrupt job can be performed, or a job can be moved down in the queue to change the job order. Tap the key of the job you want to move, and tap the "Priority Change" key.



-  key
Moves the selected job to the top of the queue. The current job will be interrupted and the selected job starts.
-  key
Moves the selected job up one position. When the second job from the top is selected, tapping this key interrupts the current job and starts the selected job.
-  key
Moves the selected job down one position.
-  key
Moves the selected job to the bottom of the queue.

Scanner job with a timer setting

When a scanner job with a timer setting is selected, tapping the order change keys moves the job as follows.

-  key
The timer setting is canceled and the job moves to the position after the job in progress (second from top).
-  key
The timer setting is canceled and the job moves to the lowest position in the queue (if there are 3 jobs, the 4th position)
-  ,  key
These keys cannot be used.



The jobs below cannot be moved.
Job currently in progress, interrupt copy jobs, list print jobs, and jobs when Passing Prohibited is set in the system settings.



Disabling of Bypass Printing

In "Settings (administrator)", select [System Settings] → [Common Settings] → [Operation Settings] → [Disabling of Bypass Printing].

This setting is used to disable bypass printing (printing other jobs ahead of a job that has been stopped* because the paper required for the job is not available in any of the trays).

* This does not include cases where the paper ran out during the job.

In print tab, you can switch the display in the "Job Queue" screen between the number of printed copies and remaining copies to be printed for each job.

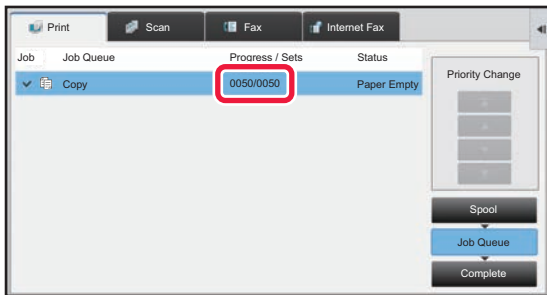

To switch the display between the numbers of printed copies and remaining copies to be printed for each job:
In "Settings (administrator)", select [System Settings] → [Common Settings] → [Operation Settings] → [Condition Settings] → [Switch the Number of Sets to be Displayed for Job Status].

CHECKING A RESERVED JOB OR THE JOB IN PROGRESS

1

Tap the job status display and tap the tab for the job whose contents you wish to check.

2

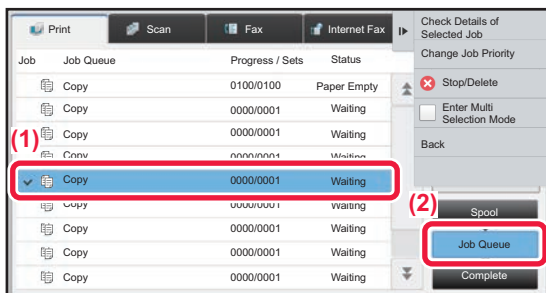

Tap the [Job Queue] key.

3

Tap the job whose contents you wish to check and then tap [Check Details of Selected Job] on the action panel.



- Different job contents appear in different modes.
- For information on the icons displayed on the job keys or the messages displayed in "Status", see "[READING THE JOB LIST \(page 23\)](#)".

CHECKING COMPLETED JOBS

1

Tap the job status display and tap the tab for the job whose contents you wish to check.

2

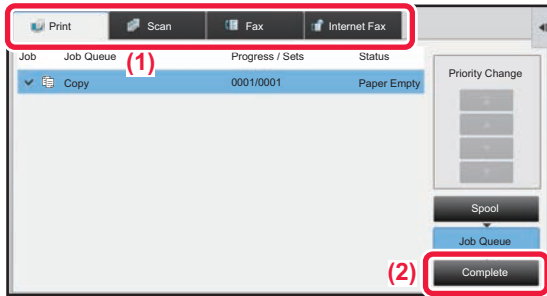

Tap the [Complete] key.

3

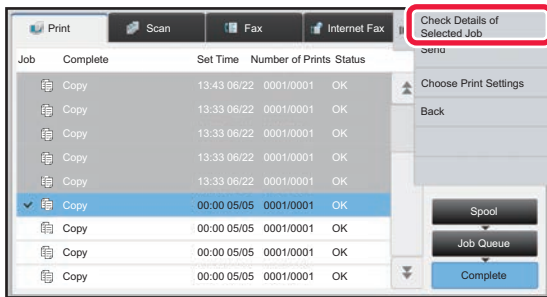

Tap the job whose contents you wish to check and then tap [Check Details of Selected Job] on the action panel.

















Jobs you can check are displayed as keys so that you can tap them.

- Different job contents appear in different modes.
- For information on the icons displayed on the job keys or the messages displayed in "Status", see "[READING THE JOB LIST \(page 23\)](#)".

READING THE JOB LIST

The meaning of each job icon and message displayed in "Status" is as follows:

Icons indicating the job type

	Print job (RGB/CMYK)		Copy job
	Scan to E-mail job		Scan to FTP job
	Scan to Network Folder job		Scan to Desktop job
	Fax transmission job		Fax reception job
	PC-Fax transmission job		Internet fax transmission job (Including Direct SMTP)
	PC-I-Fax transmission job		Scan to Local Drive file print job
	Internet fax reception job (Including Direct SMTP)		Broadcast job* Inbound routing job
	Tandem copy/print job		Broadcast job* Inbound routing job (When a destination is group destination address)
	OSA Scan Job		

* This appears in a broadcast job.

Messages displayed in "Status"

Job in progress

Display	Status
"Printing"	Print job in progress
"Copying"	Copy job in progress
"Connecting"	Connecting
"Sending"	Sending
"Receiving"	Receiving
"Processing"	Processing
"Tel"	Speaking with the other party using an extension telephone
"Stopped"	The job has been stopped
"Toner Empty"	Toner Empty
"Paper Empty"	Paper Empty
"Paper Jam"	Paper jam
"Waiting"	Waiting
"Warming up"	Warming up
"Limit"	Having reached the account limit
"Report Wait"	Transmission confirmation reception timeout
"Error"	An error occurred while the job was being executed

Reserved job

Display	Status
"Waiting"	The job is waiting to be executed
"Retry Mode"	The job is being retried due to a communication error or other problem
"Report Wait"	Waiting for confirmation of Internet fax transmission
A day and time is displayed	Timer transmission job (the specified time is displayed)

Touch Panel Operation

Completed job

Display	Status
"OK"	Normal termination
"Send OK"	Transmission was completed.
"NG Ck Line"	Fax line cable is not connected
"In Memory"	Reception completed but the fax has not been printed.
	The received data (each page) has not been printed or forwarded. (The received data has not been deleted.)
"Received"	Printed received fax data.
	The fax has been received.
	The received data (each file) was stored.
"Forward OK"	The received data/received data (each file) has been forwarded.
"FAST"	FAST transmission completed.
"Stopped"	The job was stopped.
"Delete"	Deleted received data in the image check screen.
"Number of successful transmission destinations/Total destinations OK"	Completion of a broadcast transmission, serial polling, or inbound routing operation.
	If transmission to 3 destinations was successful out of a total of 5, "003/005 OK" will appear.
"No Response"	An error occurred because there was no response from the destination.
"Busy"	An error occurred because the other party was busy.
"Received"	E-mail other than Internet fax received
"Rejected"	A fax was sent from a party that has been blocked by the anti junk fax function.
"NGxxxxx"	Transmission/reception was not successful because a communication error occurred (a 6-digit error code appears in xxxxxx.)
"Error"	An error occurred while the job was being executed.
"Limit"	Jobs exceeding the maximum size of e-mail attachments
"displayed"*	Displayed at the receiving machine when delivery confirmation is set
"dispatched"*	Forwarded elsewhere before being displayed at the receiving machine when delivery confirmation is set
"processed"*	Processed without being displayed at receiving machine when delivery confirmation is set
"deleted"*	Message deleted at receiving machine when delivery confirmation is set
"denied"*	Receiving machine refused to notify sending machine of message processing content when delivery confirmation is set
"failed"*	An abnormal condition occurred when delivery confirmation is set

* If the receiving machine is a SHARP machine, the receiving machine will return "dispatched" if the fax was received normally, or "processed" if reception failed.

When delivery confirmation is set for Internet Fax, the disposition feeld value indicated on the delivery confirmation return e-mail appears.

CUSTOMIZING THE DISPLAY (U/I Customize)

U/I Customize is a function that lets you customize the home screen and shortcut keys to make the machine easier to use.

For example, if you frequently use Tandem Copy or Card Shot, there are no settings for these functions in Easy Copy and Easy Scan. You must move to a screen with Copy or E-mail shortcut keys, select the shortcut keys, and tap the functions.

By moving these shortcut keys to the initial page of the home screen, you can quickly select the functions. Try customizing the display to make the machine easier to use.

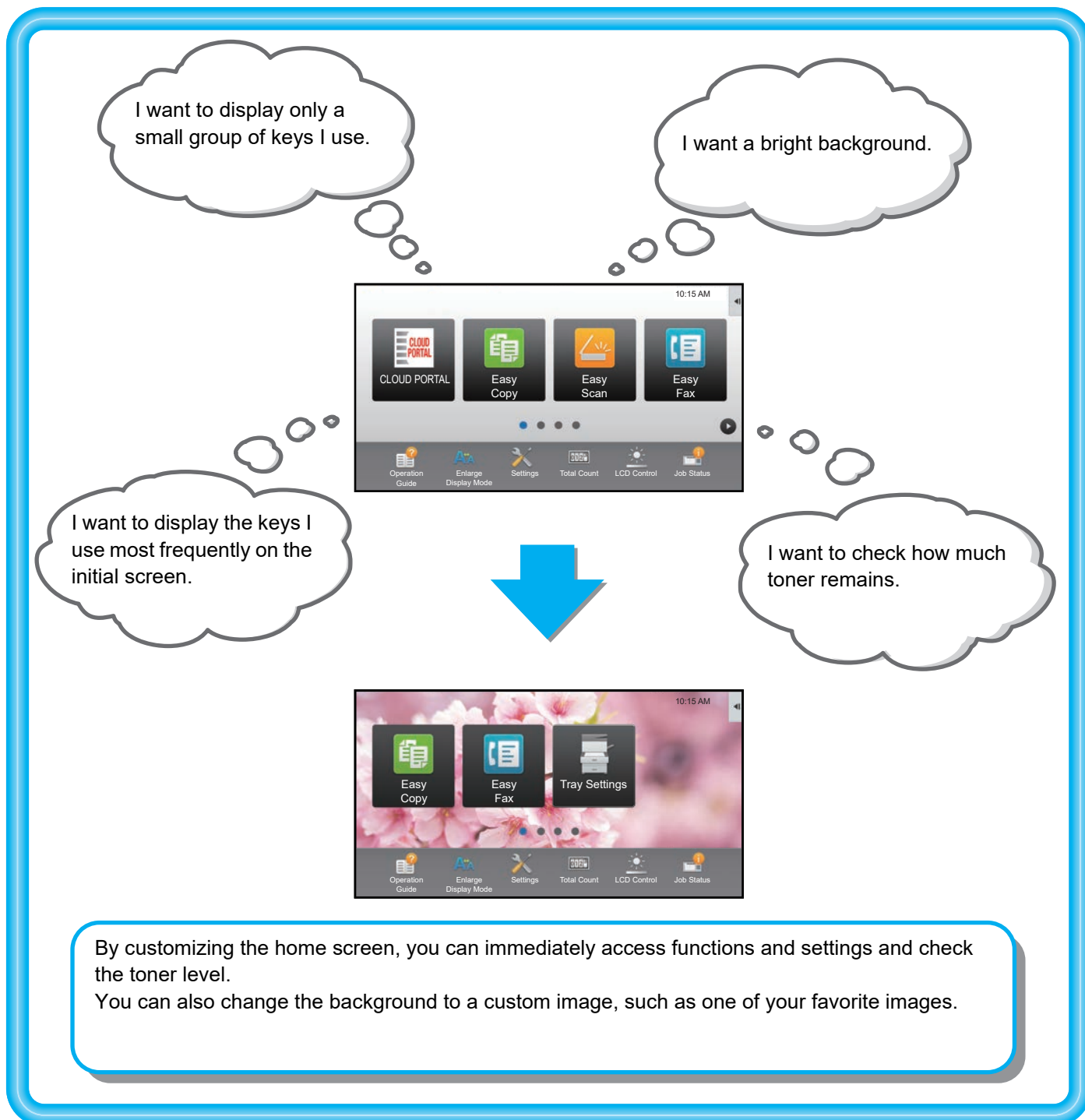

ITEMS YOU CAN CUSTOMIZE

You can customize the following items.

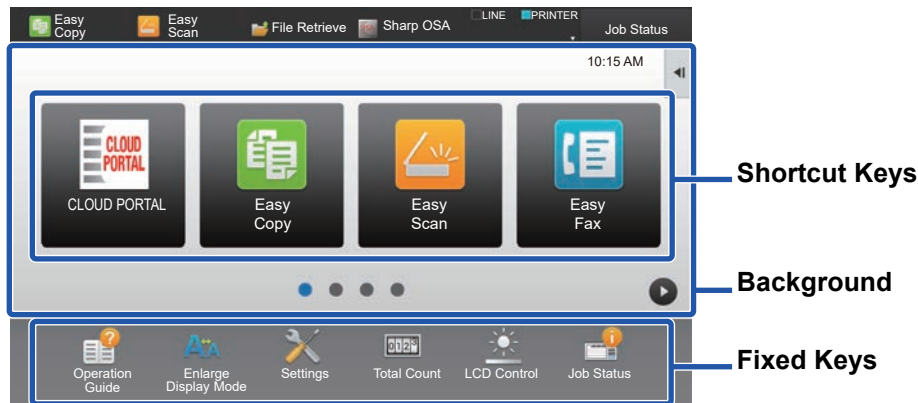

Add a frequently used shortcut key

You can display functions on the home screen that do not normally appear, and immediately select those functions.

▶ [ADDING SHORTCUT KEYS \(page 32\)](#)

Delete the shortcut keys that appear

You can delete and organize the shortcut keys that appear in the home screen.

▶ [DELETING A SHORTCUT KEY \(page 35\)](#)

Change the shortcut keys that appear

You can change shortcut keys, and change the layout of the shortcut keys.

▶ [CHANGING A SHORTCUT KEY \(page 37\)](#)

Change a shortcut key image to a custom image

You can store images in advance to customize shortcut keys.

▶ [ADDING A SHORTCUT KEY IMAGE \(page 40\)](#)

Change the layout of the shortcut keys

You can change the layout of the shortcut keys by moving the keys to positions that are easy to use.

▶ [MOVING A SHORTCUT KEY \(page 42\)](#)

Restore the original layout of the shortcut keys

If you accidentally move shortcut keys, you can restore the keys to the factory default layout.

▶ [RETURNING THE SHORTCUT KEYS TO THE FACTORY DEFAULT STATE \(page 44\)](#)

Touch Panel Operation

Change the layout of the home screen

You can change the layout of the home screen to add more shortcut keys.

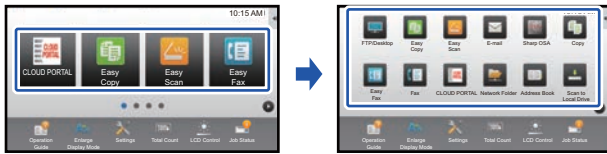

- ▶ [CHANGING THE LAYOUT PATTERN OF THE HOME SCREEN \(page 46\)](#)

Change the background color of the home screen

You can change the background color of the home screen to a preset pattern color.

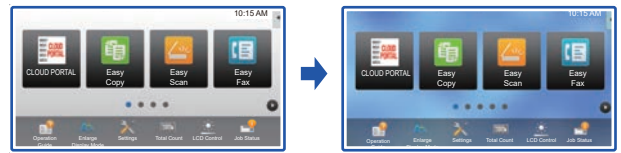

- ▶ [SELECTING A MFP DISPLAY PATTERN FOR THE HOME SCREEN \(page 48\)](#)

Change the color of the text on the home screen

You can change the color of the text on the home screen to white or black.

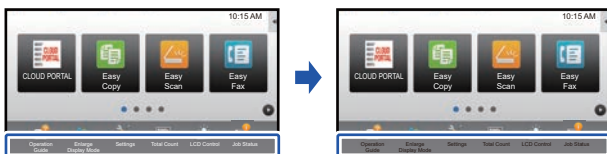

- ▶ [CHANGING THE COLOR OF TEXT ON THE HOME SCREEN \(page 49\)](#)

Change the background to a custom image

You can change the home screen background as desired.

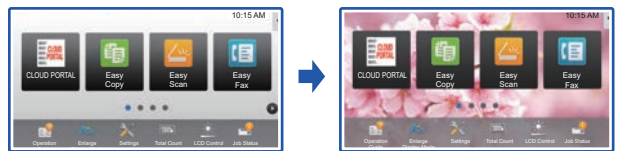

- ▶ [CHANGING THE BACKGROUND IMAGE OF THE HOME SCREEN \(page 50\)](#)

Change the contents of the fixed keys

You can change the fixed keys and hide toner usage.

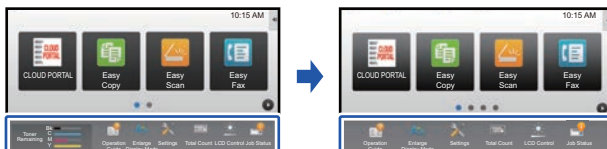

- ▶ [CHANGING THE FIXED KEYS \(page 53\)](#)

Enlarge displayed text

You can enlarge the text that appears in normal mode of copying and image send.

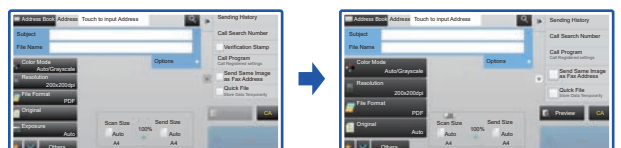

- ▶ [INCREASING THE TEXT SIZE \(page 55\)](#)

Change the language

You can change the language that is displayed.



- ▶ [CHANGING THE LANGUAGE USED ON THE MACHINE \(page 56\)](#)

GENERAL PROCEDURE FOR USING U/I CUSTOMIZE

To change the home screen or shortcut keys, configure settings in the action panel of the home screen or on the Web page.

The settings must be configured by the administrator of the machine.



This general procedure is not used for "CHANGING THE FIXED KEYS" ([▶page 53](#)), "INCREASING THE TEXT SIZE" ([▶page 55](#)), or "CHANGING THE LANGUAGE USED ON THE MACHINE" ([▶page 56](#)). Follow the procedures in each of the above sections.

General procedure when using the touch panel

1

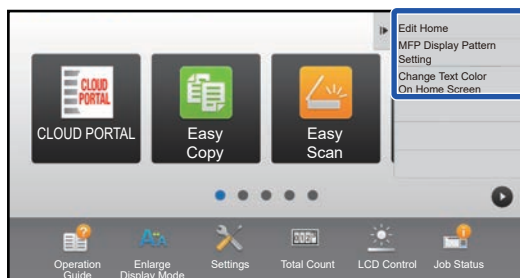

Open the action panel of the home screen, and tap one of the displayed items.

The items that appear on the action panel are "Edit Home", "MFP Display Pattern Setting", and "Change Text Color On Home Screen".

- [Edit Home]
 - ▶ [ADDING SHORTCUT KEYS \(page 32\)](#)
 - ▶ [DELETING A SHORTCUT KEY \(page 35\)](#)
 - ▶ [CHANGING A SHORTCUT KEY \(page 37\)](#)
 - ▶ [MOVING A SHORTCUT KEY \(page 42\)](#)
 - ▶ [RETURNING THE SHORTCUT KEYS TO THE FACTORY DEFAULT STATE \(page 44\)](#)
- [MFP Display Pattern Setting]
 - ▶ [SELECTING A MFP DISPLAY PATTERN FOR THE HOME SCREEN \(page 48\)](#)
- [Change Text Color On Home Screen]
 - ▶ [CHANGING THE COLOR OF TEXT ON THE HOME SCREEN \(page 49\)](#)

2

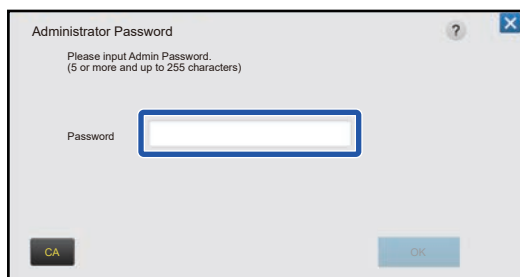

The administrator password screen appears. Enter your password.

Enter the administrator password.

3

Configure the settings.

4

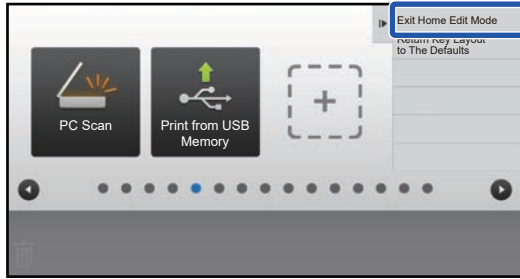

After the settings are completed, tap **[Exit Home Edit Mode]**.

If [MFP Display Pattern Setting] or [Change Text Color On Home Screen] is selected, tap [Finish and Return]. After all U/I customize settings are completed, tap the [Logout] key.

General procedure when using the Web page

1

Enter the IP address of the machine in your Web browser to access the Web server.

In the factory default state, you must enter your user password after entering the IP address.

2

On the Web page, click the **[System Settings]** tab → **[Home Screen Settings]**.

Some settings may require that you enter your user password after clicking [Home Screen Settings]. If you did not perform user authentication, you must enter the administrator password.

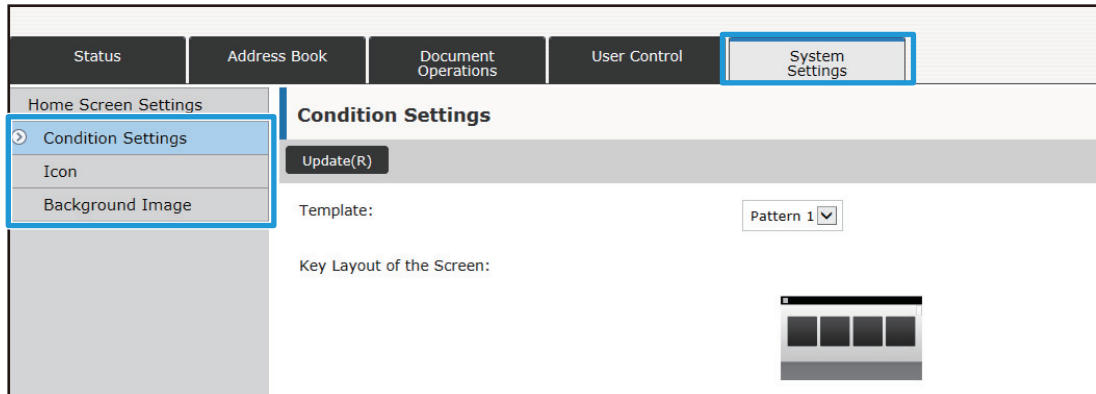

3

Configure the settings.

4

When you have finished configuring the settings, click the [Submit] button.

The settings are saved in the machine and applied.

Class Book	Document Operations	User Control	System Settings
1. Scrolling Area:		<input checked="" type="radio"/>	White
		<input type="radio"/>	Black
2. Fixed Area:		<input checked="" type="radio"/>	White
		<input type="radio"/>	Black
3. Clock:		<input type="radio"/>	White
		<input checked="" type="radio"/>	Black
<input type="button" value="Submit(U)"/>			

When you have finished all U/I Customize settings, click the [Logout] button and close your Web browser.

EDITING SHORTCUT KEYS

You can add shortcut keys to the home screen, and delete unneeded shortcut keys.

You can also change the display order of the shortcut keys and change names and images to make the machine easier to use.

ADDING SHORTCUT KEYS

This section explains how to add a shortcut key to the home screen.

You can add a shortcut key using the touch panel, or from the Web page. In the Web page, you can change a shortcut key image to any custom image.



From the touch panel

1

Open the action panel on the home screen, and tap [Edit Home].

▶ [General procedure when using the touch panel \(page 29\)](#)

2

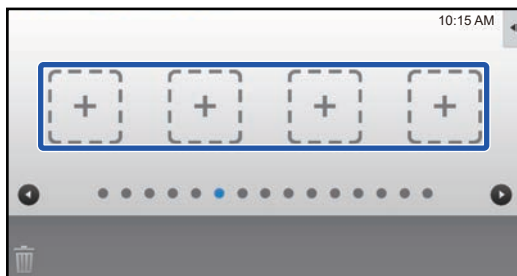

Tap an empty shortcut key location.

3

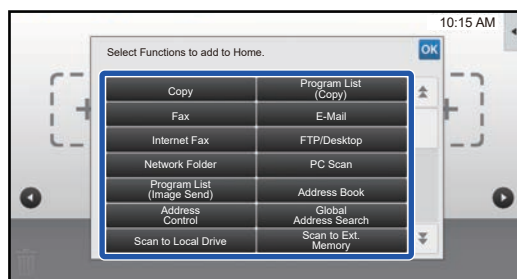

Tap the function you want to add.

The shortcut key will be added to the selected location.

4

See "[General procedure when using the touch panel](#)" (▶ [page 29](#)) to exit the settings.

From the Web page

1

See "**General procedure when using the Web page**" ([▶ page 30](#)) to open the settings screen.

2

Click [**Condition Settings**], and click [**Not Set**].

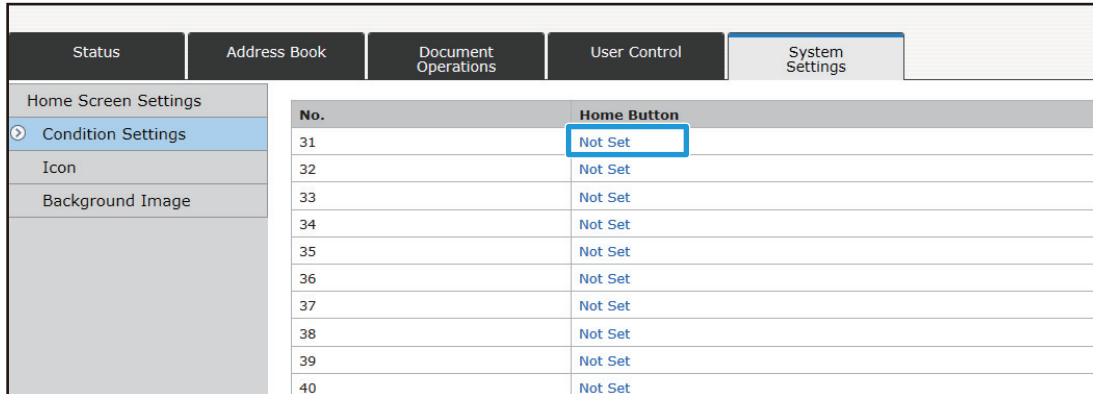

No.	Home Button
31	Not Set
32	Not Set
33	Not Set
34	Not Set
35	Not Set
36	Not Set
37	Not Set
38	Not Set
39	Not Set
40	Not Set

3

Select the function you want to add.

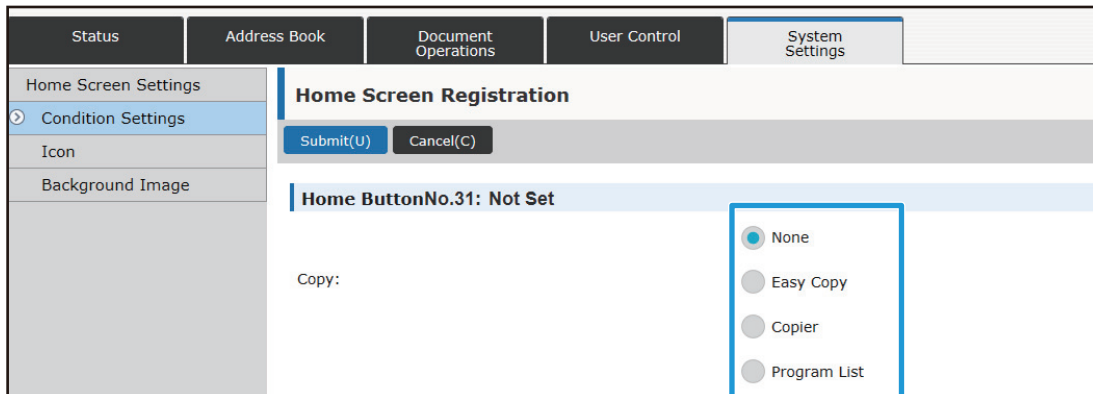

Home Screen Registration

Submit(U) Cancel(C)

Home ButtonNo.31: Not Set

Copy:

- None
- Easy Copy
- Copier
- Program List

To change the name of a shortcut key, select [Custom] in [Key Name] and enter the desired name in the text box.

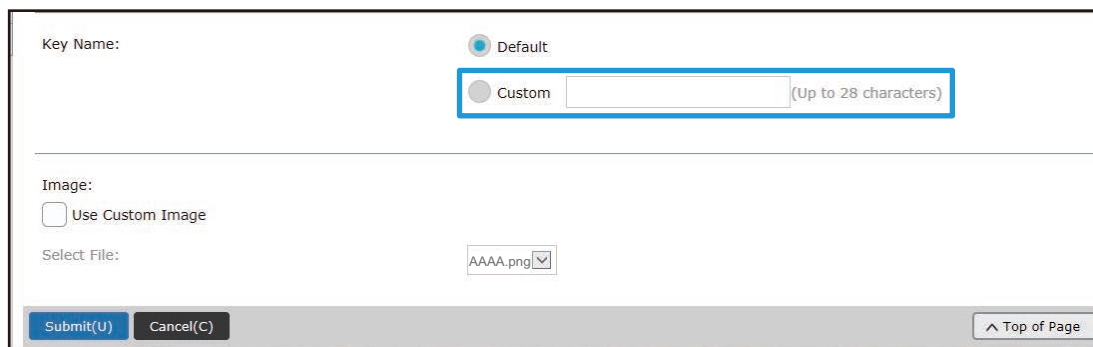

Key Name:

Default

Custom (Up to 28 characters)

Image:

Use Custom Image

Select File:

Submit(U) Cancel(C) [^ Top of Page](#)

To change the image of a shortcut key, go to the next step. If you are not changing the image, go to step 5.

4

To change the image of a shortcut key, set the [Use Custom Image] checkbox to , and select a previously added image with [Select File].

To save an image, see "ADDING A SHORTCUT KEY IMAGE" ([▶ page 40](#)).

5

See "[General procedure when using the Web page](#)" ([▶ page 30](#)) to exit the settings.

DELETING A SHORTCUT KEY

This section explains how to delete a shortcut key from the home screen. You can delete from the touch panel or from the Web page.



From the touch panel

1 Open the action panel on the home screen, and tap [Edit Home].

▶ [General procedure when using the touch panel \(page 29\)](#)

2

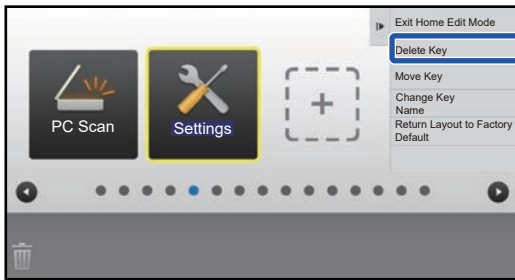

Tap the shortcut key you want to delete, and tap [Delete Key].

A yellow frame appears around the selected shortcut key. With the shortcut key selected, tap . You can also delete by dragging the shortcut key to .

3

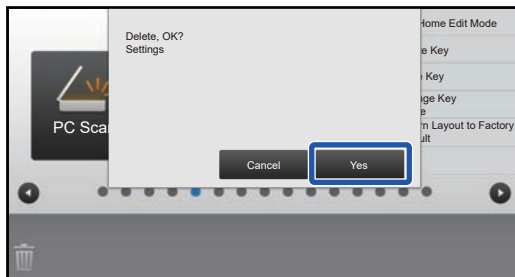

Tap the [Yes] key.

The selected shortcut key will be deleted.

4

See "[General procedure when using the touch panel](#)" ([▶ page 29](#)) to exit the settings.

From the Web page

1 See "[General procedure when using the Web page](#)" ([▶ page 30](#)) to open the settings screen.

2 Click [Condition Settings] and click the shortcut key you want to delete.

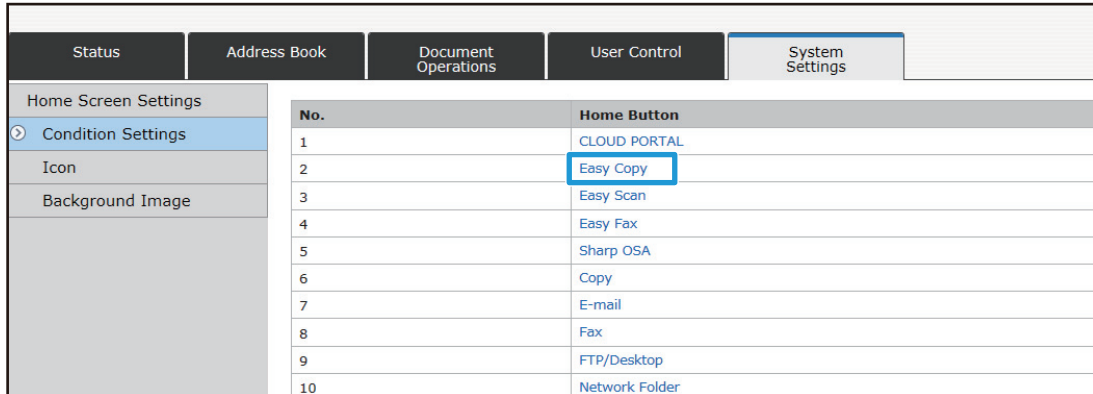

The screenshot shows the 'System Settings' page with a sidebar menu containing 'Home Screen Settings', 'Condition Settings', 'Icon', and 'Background Image'. The 'Condition Settings' table is displayed with the following data:

No.	Home Button
1	CLOUD PORTAL
2	Easy Copy
3	Easy Scan
4	Easy Fax
5	Sharp OSA
6	Copy
7	E-mail
8	Fax
9	FTP/Desktop
10	Network Folder

3 Select [None] and click the [Submit] button.

When you click the [Submit] button, the [Home Screen Registration] screen closes.

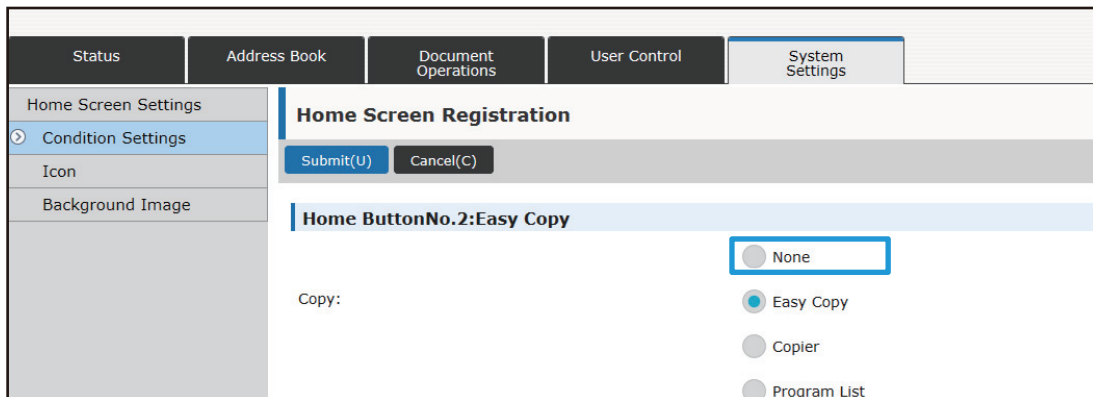

The screenshot shows the 'Home Screen Registration' screen. At the top, there are 'Submit(U)' and 'Cancel(C)' buttons. Below, the title is 'Home ButtonNo.2:Easy Copy'. Under the 'Copy:' label, there are four radio button options: 'None' (selected), 'Easy Copy', 'Copier', and 'Program List'.

4 See "[General procedure when using the Web page](#)" ([▶ page 30](#)) to exit the settings.

CHANGING A SHORTCUT KEY

This section explains how to change a shortcut key in the home screen.

Only the name can be changed from the touch panel. You can change the icon image from the Web page.

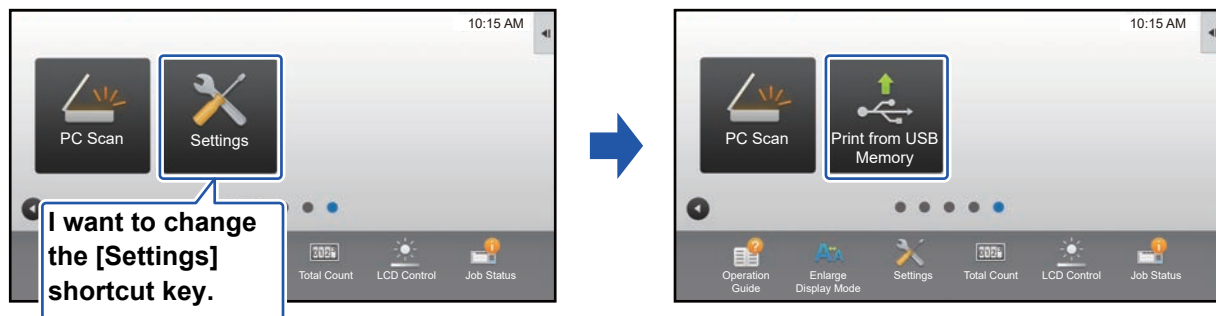

From the touch panel

To change a shortcut key from the touch panel, move the shortcut key in the desired location away from that location, and then register the new shortcut key in the location that has been freed. For information about how to move shortcut keys, see "[MOVING A SHORTCUT KEY](#)" ([▶page 42](#)). For information about how to add shortcut keys, see "[ADDING SHORTCUT KEYS](#)" ([▶page 32](#)).

This section explains how to change the name of a shortcut key.

1

Open the action panel on the home screen, and tap [Edit Home].

▶ [General procedure when using the touch panel \(page 29\)](#)

2

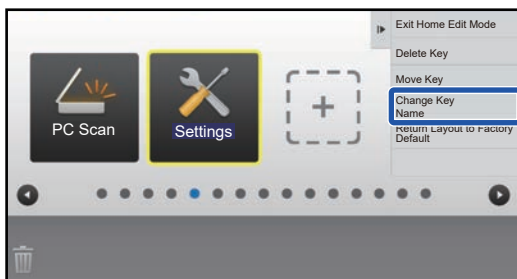

Tap the shortcut key whose name you want to change, and tap [Change Key Name].

A yellow frame appears around the selected shortcut key.

3



Enter the new name by keyboard.

Enter the name, and tap the [OK] key.

4

See "[General procedure when using the touch panel](#)" ([▶page 29](#)) to exit the settings.

From the Web page

1 See "[General procedure when using the Web page](#)" ([▶ page 30](#)) to open the settings screen.

2 Click [Condition Settings], and click the shortcut key you want to change.

System Settings	
Status	Address Book
Document Operations	User Control
System Settings	
Home Screen Settings	
Condition Settings	
Icon	
Background Image	
No.	Home Button
1	CLOUD PORTAL
2	Easy Copy
3	Easy Scan
4	Easy Fax
5	Sharp OSA
6	Copy
7	E-mail
8	Fax
9	FTP/Desktop
10	Network Folder

3 Select the desired function.

System Settings	
Status	Address Book
Document Operations	User Control
System Settings	
Home Screen Settings	
Condition Settings	
Icon	
Background Image	
Home Screen Registration	
Submit(U) Cancel(C)	
Home ButtonNo.2:Easy Copy	
Copy:	<input type="radio"/> None <input checked="" type="radio"/> Easy Copy <input type="radio"/> Copier <input type="radio"/> Program List

To change the name of a shortcut key, select [Custom] in [Key Name] and enter the desired name in the text box.

Key Name:	<input checked="" type="radio"/> Default <input type="radio"/> Custom <input type="text" value=""/> (Up to 28 characters)
Image:	<input type="checkbox"/> Use Custom Image
Select File:	<input type="text" value="AAAA.png"/>
Submit(U) Cancel(C) ^ Top of Page	

To change the image of a shortcut key, go to the next step. If you are not changing the image, go to step 5.

4 To change the icon image, set the [Use Custom Image] checkbox to , and select a previously added image with [Select File].

To save an image, see "[ADDING A SHORTCUT KEY IMAGE](#)" ([▶ page 40](#)).

5

See "[General procedure when using the Web page](#)" ([▶ page 30](#)) to exit the settings.

ADDING A SHORTCUT KEY IMAGE

To change a shortcut key image to a new image, you must first add the new image. This section explains how to add an image. Images are added by using the Web page.

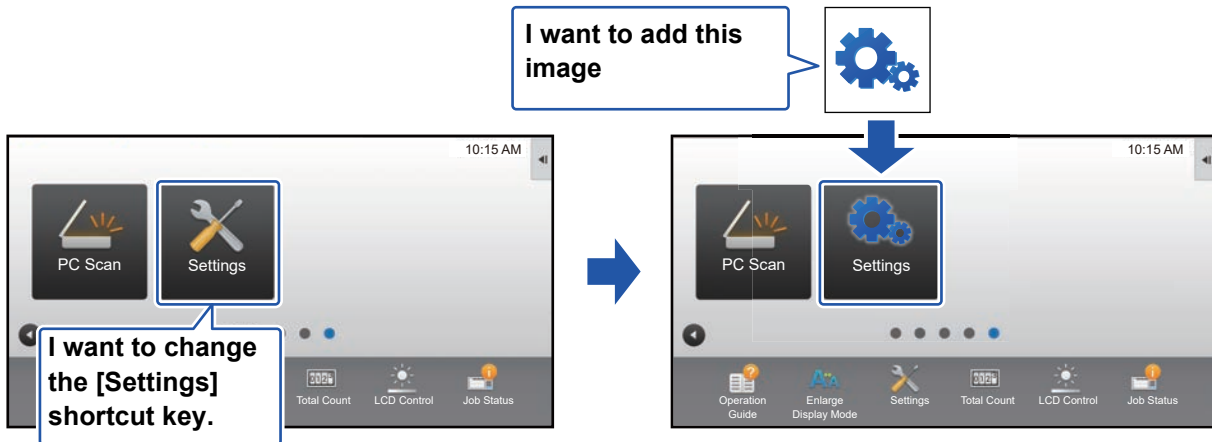

Icon images are automatically enlarged or reduced to match the size of the shortcut keys.

1

See "[General procedure when using the Web page](#)" ([▶ page 30](#)) to open the settings screen.

2

Click [Icon].

3

Select any item

If you are adding a new image, click "Not Set". If "Not Set" items are all in use, click an unneeded item in the already added items.

Status		Address Book		Document Operations		User Control		System Settings	
Home Screen Settings		Icon							
Condition Settings		Update(R)							
Icon		No.	Name						
Background Image		1	Not Set						
		2	Not Set						
		3	Not Set						
		4	Not Set						
		5	Not Set						
		6	Not Set						
		7	Not Set						
		8	Not Set						
		9	Not Set						
		10	Not Set						

4

Select the file to be added in "Select File".

Click the [Browse] button, and select the image to be submitted.



- File formats that can be used are JPEG, GIF and PNG (jpeg, jpg, jpe, jfif, gif and png).
 - The maximum file size of an image that can be used for a shortcut key is 50 KB.
-

5

See "[General procedure when using the Web page](#)" ([▶ page 30](#)) to exit the settings.

MOVING A SHORTCUT KEY

This section explains how to move a shortcut key in the home screen. Shortcut keys are moved by using the touch panel.



1

Open the action panel on the home screen, and tap [Edit Home].

▶ [General procedure when using the touch panel \(page 29\)](#)

2

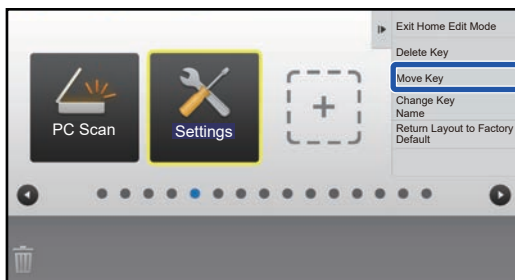

Tap the shortcut key you want to move, and tap [Move Key].

A yellow frame appears around the selected shortcut key.

3

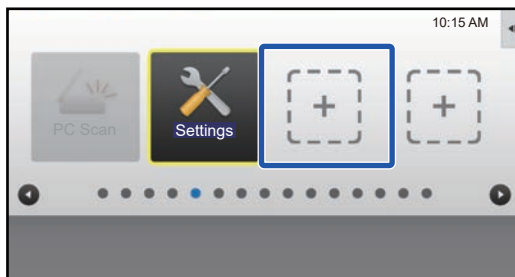

Tap an empty shortcut key location

The shortcut key moves to the tapped location.

The shortcut key will not move if you tap a location that already has a shortcut key.

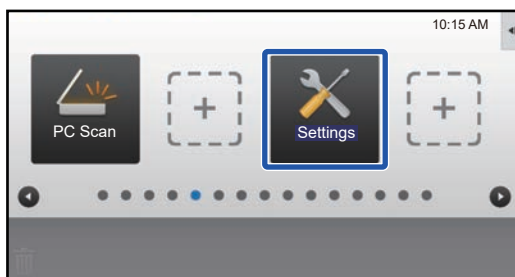

4

See "[General procedure when using the touch panel](#)" ([▶ page 29](#)) to exit the settings.

RETURNING THE SHORTCUT KEYS TO THE FACTORY DEFAULT STATE

This section explains how to return the shortcut keys in the home screen to the factory default state. This procedure can be performed from the touch panel or from the Web page.

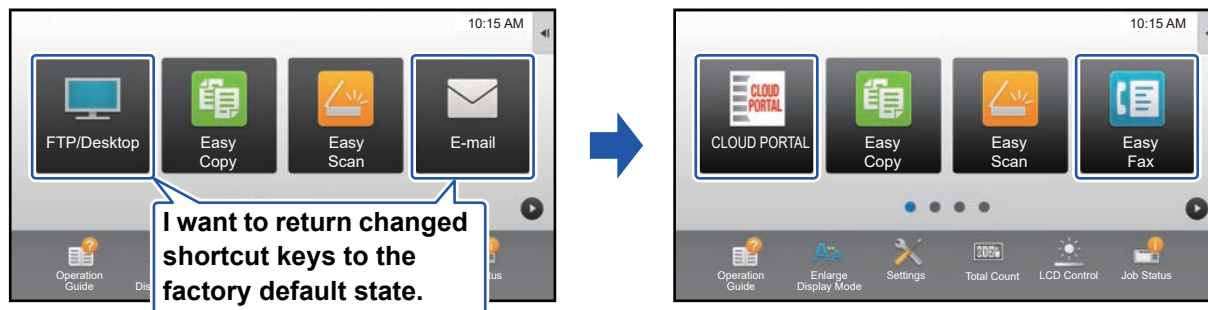

The positions, names, and images of the shortcut keys are returned to the factory default state.

From the touch panel

1

Open the action panel on the home screen, and tap [Edit Home].

▶ [General procedure when using the touch panel \(page 29\)](#)

2

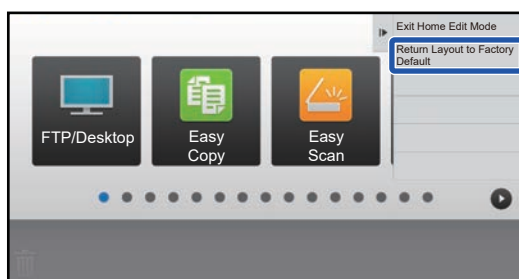

Tap [Return Layout to Factory Default] on the action panel.

3

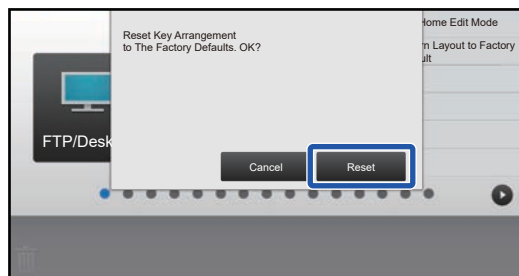

Tap the [Reset] key.

The shortcut keys are returned to the factory default state.

4

See "[General procedure when using the touch panel](#)" (▶ [page 29](#)) to exit the settings.

From the Web page

1 See "[General procedure when using the Web page](#)" ([▶ page 30](#)) to open the settings screen.

2 Click **[Condition Settings]**, and click the **[Return to the Defaults]** button.
A confirmation window appears. Click the **[OK]** button.

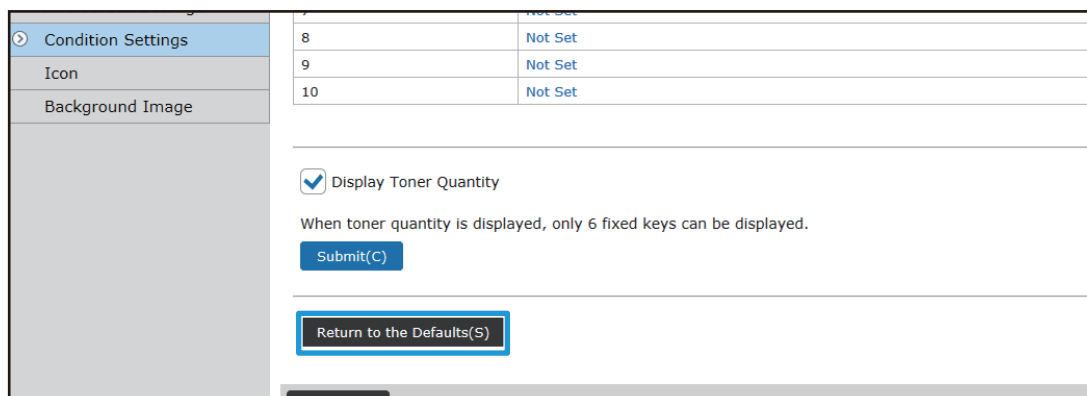

3 See "[General procedure when using the Web page](#)" ([▶ page 30](#)) to exit the settings.

EDITING THE HOME SCREEN

In the home screen, you can change the number of shortcut keys shown and change shortcut keys. This includes changing the background and text color, and changing the background to a custom image.

CHANGING THE LAYOUT PATTERN OF THE HOME SCREEN

Multiple home screen layout patterns are preset in the machine. These include a layout pattern that reduces the display size of the shortcut keys to increase the number of keys shown, and a layout pattern that eliminates the fixed key display area to increase the number of shortcut keys shown. The layout pattern can be changed in the Web page.

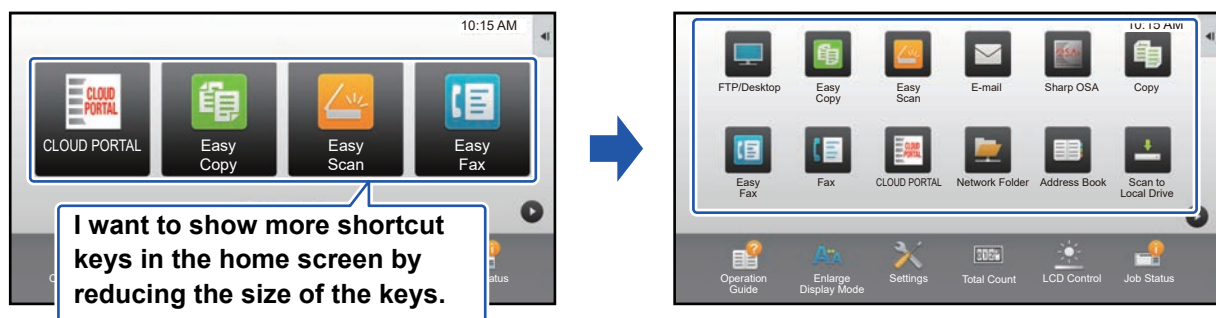

Home screen layout patterns

Six layout patterns are available.

Pattern	Number of shortcut keys displayed per screen	Fixed key area	Maximum number of screens
1	4	Yes	15 screens
2	8	No	8 screens
3	8	Yes	8 screens
4	12	No	5 screens
5	12	Yes	5 screens
6	18	No	4 screens



The factory default state varies by model. For the factory default settings, refer to the system settings in the user's manual.

1

See "[General procedure when using the Web page](#)" ([▶ page 30](#)) to open the settings screen.

2

Click [Condition Settings] and select the desired layout pattern from the "Template".

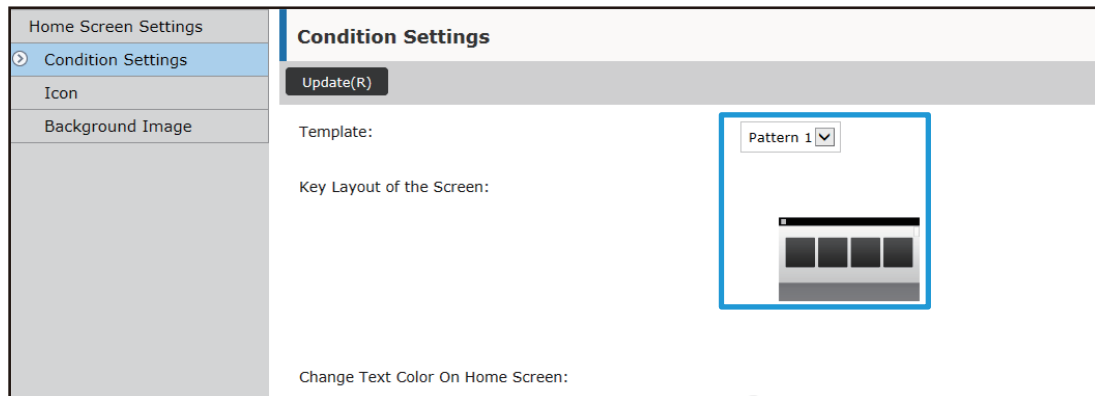

3

See "[General procedure when using the Web page](#)" ([▶ page 30](#)) to exit the settings.

SELECTING A MFP DISPLAY PATTERN FOR THE HOME SCREEN

Multiple color patterns are preset in the machine. You can change the color pattern from the touch panel.



The factory default setting is "Pattern 1".

1

Open the action panel on the home screen, and tap [MFP Display Pattern Setting].

▶ [General procedure when using the touch panel \(page 29\)](#)

2

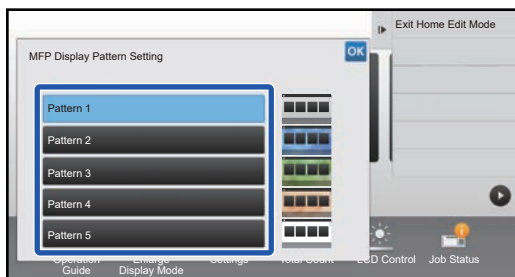

Select the desired pattern.

3

See "[General procedure when using the touch panel](#)" (▶ [page 29](#)) to exit the settings.

CHANGING THE COLOR OF TEXT ON THE HOME SCREEN

You can change the color of the text in shortcut keys, fixed keys, and the clock on the home screen to white or black. The color is changed using the touch panel.

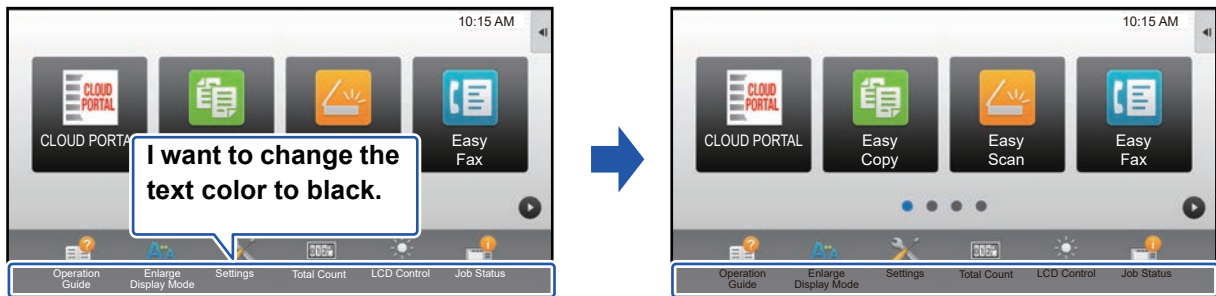

Home screen layout patterns and text colors

The color of text on the home screen varies depending on the layout pattern.

For information about layout patterns of the home screen, see "[CHANGING THE LAYOUT PATTERN OF THE HOME SCREEN](#)" ([▶page 46](#)).

Factory default text colors

Layout Pattern	Scrolling Area (Text color of shortcut key)	Fixed Area (Text color of fixed keys)	Clock (Text color of clock)
1	White	White	Black
2	White	No	Black
3	Black	White	Black
4	Black	No	Black
5	Black	White	Black
6	Black	No	Black

1

Open the action panel on the home page and tap [Change Text Color On Home Screen].

▶ [General procedure when using the touch panel \(page 29\)](#)

2

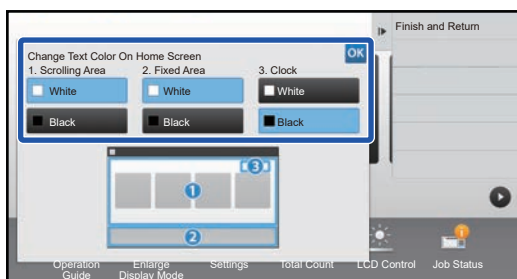

Change the text color.

3

See "[General procedure when using the touch panel](#)" ([▶page 29](#)) to exit the settings.

CHANGING THE BACKGROUND IMAGE OF THE HOME SCREEN

You can change the background image of the home screen to a custom image.

This procedure can be performed from the touch panel or from the Web page.

To change the image from the touch panel, first save the desired image in a USB device and connect the device to the machine.



The display size of the background image is 1024 dots x 544 dots.

The height of the image is adjusted to the display height, and the width is adjusted to the display width.

Because the height and width are enlarged/reduced separately, some images may become distorted.

If you want to display the image correctly, adjust the size of the image to the display size of the background image in advance.

From the touch panel

1

Connect the USB device containing the desired image to the machine.

When the USB device is connected to the machine, the popup window will be appeared. Tap the [OK] key.

2

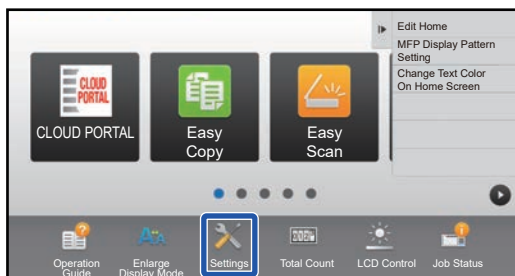

Tap the [Settings] key on the Home screen.

The screen changes to the settings screen.

3

Tap [System Settings] → [Home Screen Settings] → [Background Image], and then tap [Change] key.

The "Register Background Image" screen will be appeared.



The administrator password entry screen will appear while you are selecting settings.

Enter the administrator password and log in.

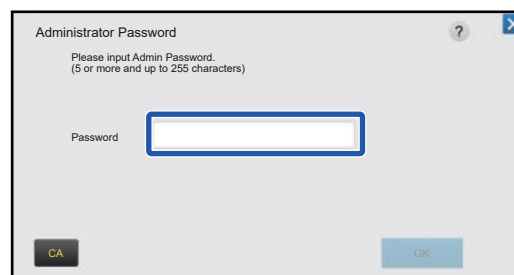

4

Set the [Use Custom Image] checkbox to , and select the desired image with [Folder Name/File Name].



- File formats that can be used are JPEG, GIF and PNG (jpeg, jpg, jpe, jff, gif and png).
- The maximum file size of an image that can be used for the background image is 640 KB.

5

Click the [Store] button.

After all U/I customize settings are completed, tap the [Logout] key.

From the Web page

1

See "[General procedure when using the Web page](#)" ([▶ page 30](#)) to open the settings screen.

2

Click the [Change] button in [Background Image].

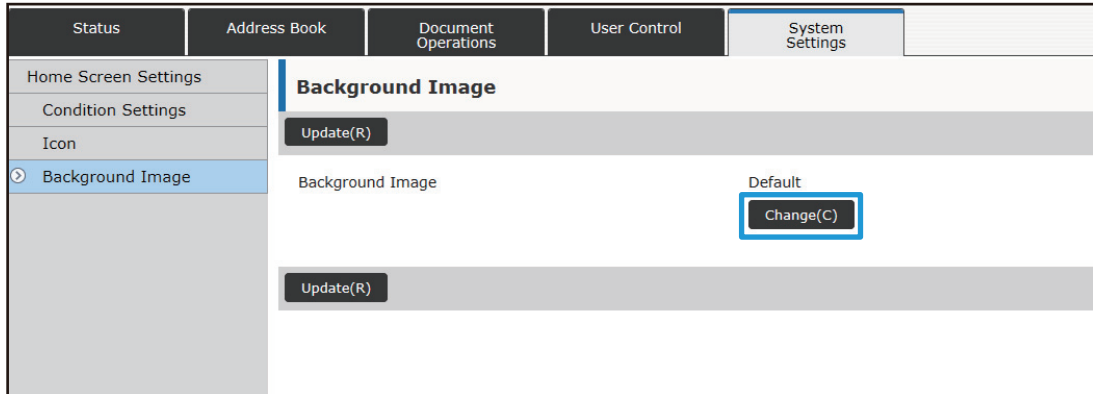

3

Set the [Use Custom Image] checkbox to , and select the image with [Select File].

Click [Browse] to select the image.

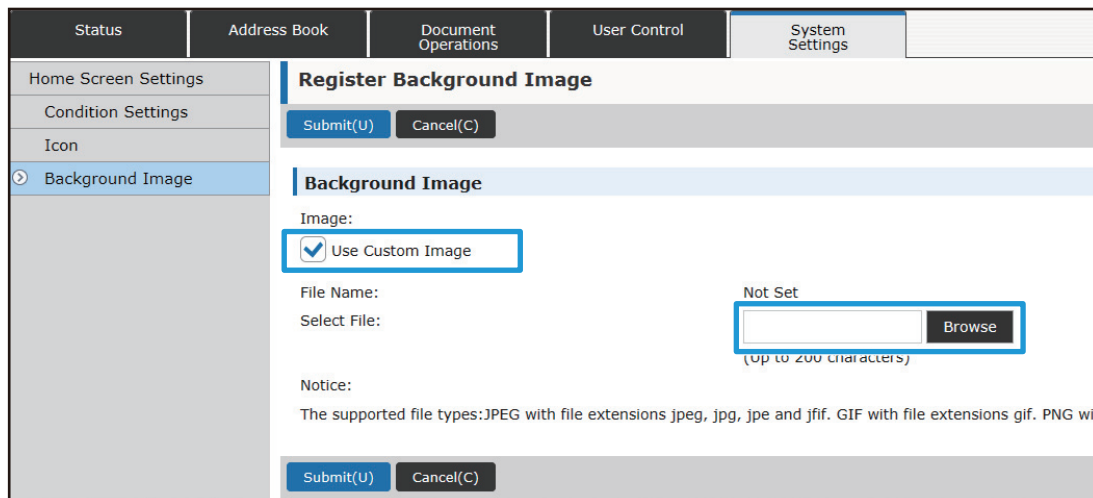

- File formats that can be used are JPEG, GIF and PNG (jpeg, jpg, jpe, jfif, gif and png).
- The maximum file size of an image that can be used for the background image is 640 KB.

4

See "[General procedure when using the Web page](#)" ([▶ page 30](#)) to exit the settings.

CHANGING THE FIXED KEYS

You can change the fixed keys. The fixed keys are changed using the Web page.

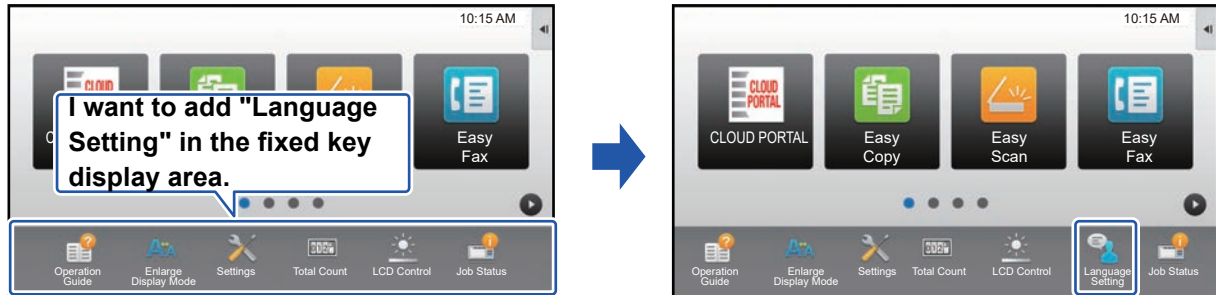

1

See "[General procedure when using the Web page](#)" ([▶ page 30](#)) to open the settings screen.

2

Click [Condition Settings], and click the desired item under "Fix Key".
You can click [Not Set] to add a new fixed key.

No.	Fix Key
1	Operation Guide
2	Enlarge Display Mode
3	System Settings
4	Total Count
5	LCD Control
6	Job Status
7	Not Set
8	Not Set
9	Not Set
10	Not Set

3

Select the function you want to add, and click the [Submit] button.
When you click the [Submit] button, the [Home Screen Registration] screen closes.

4

See "[General procedure when using the Web page](#)" ([▶ page 30](#)) to exit the settings.

Show/hide the toner level in the fixed area

In the system settings, you can show/hide the toner level to the fixed key area.

When this setting is enabled, up to six fixed keys can be displayed. (The keys from No. 1 to No. 6 in Web page "Fix Key" (Except when not set) are displayed. Keys after No. 6 are not displayed.)

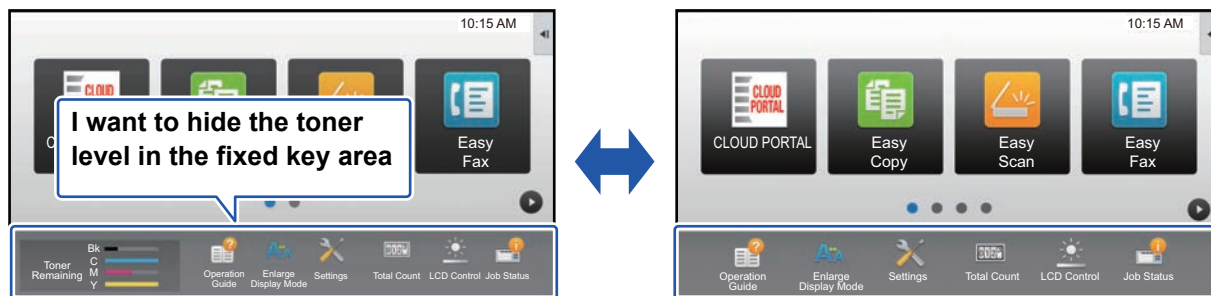

1

See "[General procedure when using the Web page](#)" ([▶ page 30](#)) to open the settings screen.

2

Click [Condition Settings] and set [Display Toner Quantity].

When the [Display Toner Quantity] checkbox is , the toner level appears. When the [Display Toner Quantity] checkbox is , the toner level is hidden.

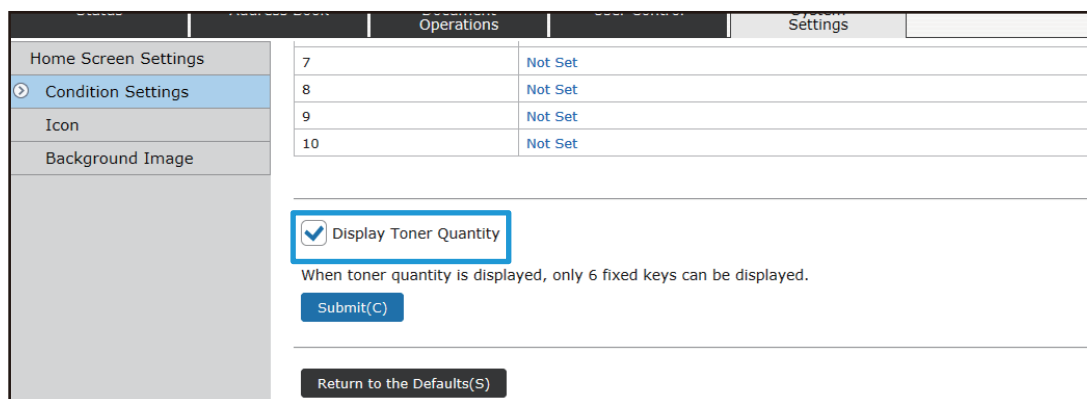

3

See "[General procedure when using the Web page](#)" ([▶ page 30](#)) to exit the settings.

INCREASING THE TEXT SIZE

In a Normal mode screen such as copy or image send, you can enlarge the character size and interval. This function is selected on the touch panel.

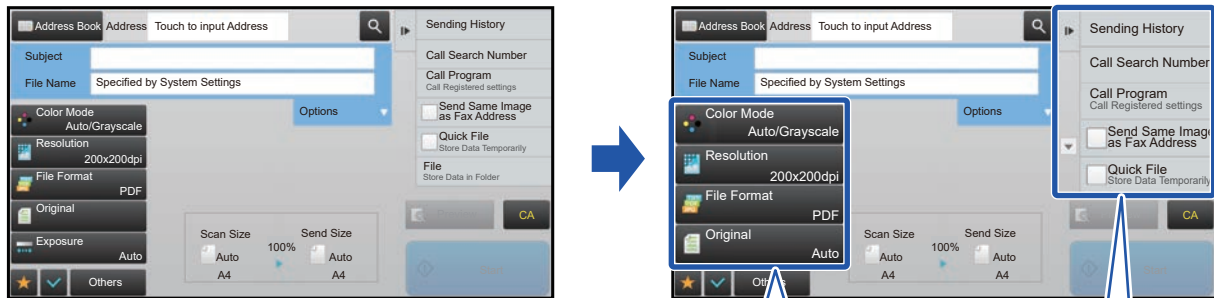

Setting keys and the action panel are enlarged.
Setting items that no longer appear on the action panel can be displayed by tapping the scroll keys.
Setting keys that no longer appear (the [Exposure] key in this example) can be displayed by tapping the [Others] key.



- In screens other than Normal mode of each function such as Easy mode and settings, the size of characters and keys does not change.
- Increasing the text size may decrease the number of keys displayed in the base screen and other screens of each function.

1

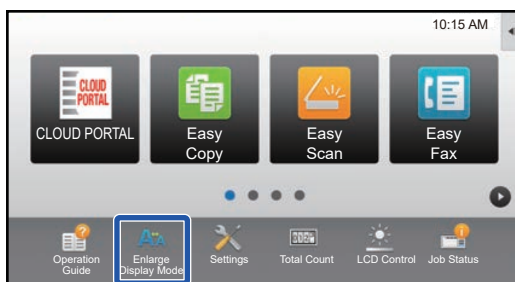

Tap the [Enlarge Display Mode] key in the home screen.

The key image changes to  and enlarge display mode is enabled.

To cancel enlarge display mode, tap the [Enlarge Display Mode] key again. The key image changes to  and enlarge display mode is canceled.

CHANGING THE LANGUAGE USED ON THE MACHINE

You can change the language used in the home screen.

This procedure is performed from the touch panel.

Before performing this procedure, add the [Language Setting] shortcut key to the home screen. To add a shortcut key, see "ADDING SHORTCUT KEYS" (▶page 32).



1

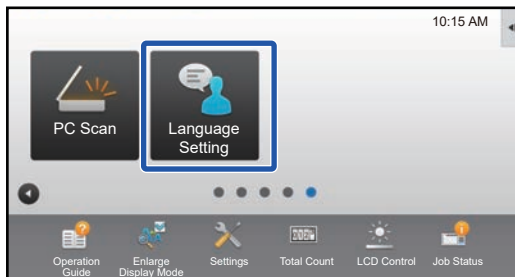

Tap the [Language Setting] key on the home screen.

2



Select the desired language and tap **OK**.

The display changes to the selected language.

CHARACTER ENTRY

NAMES AND FUNCTIONS OF SOFT KEYBOARD KEYS

Display the soft keyboard to register the name of a file, program, folder or user.

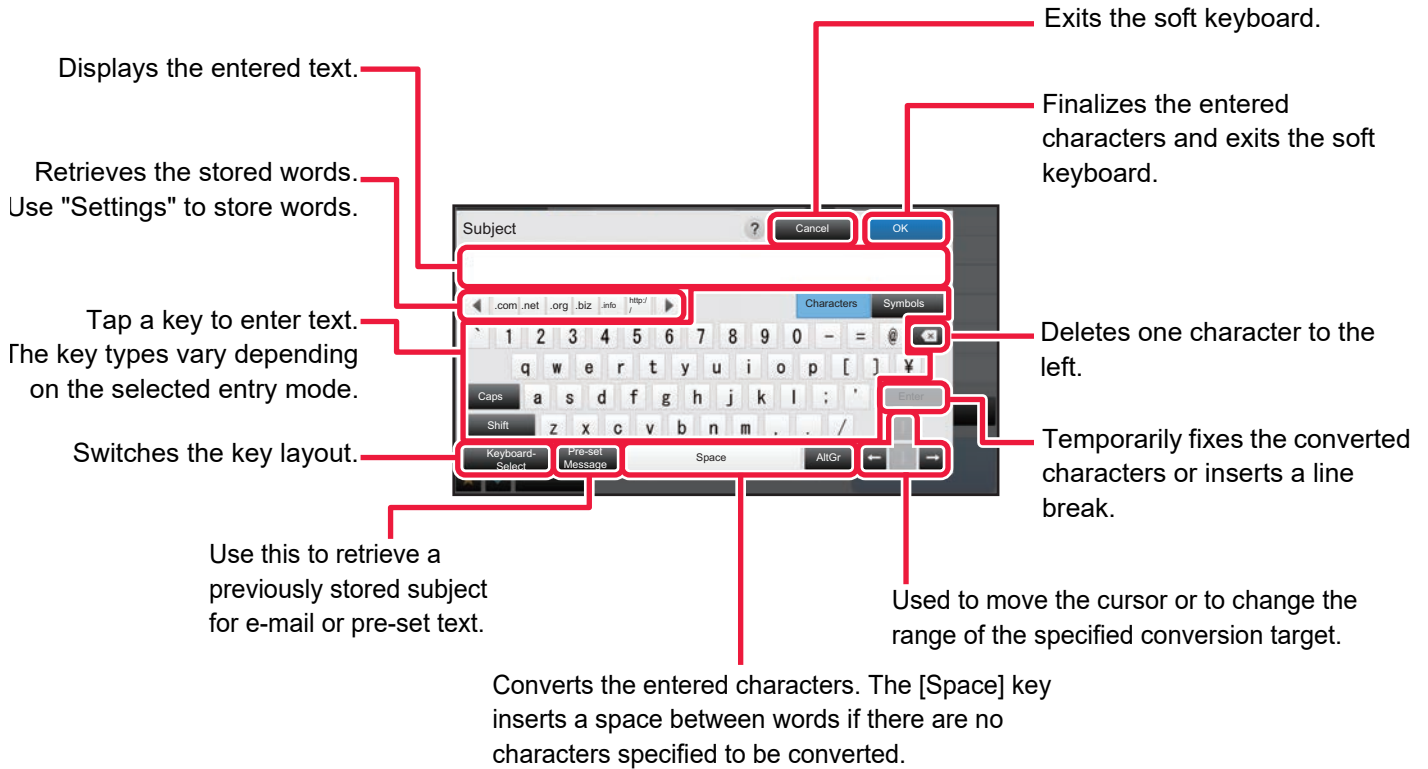

 The soft keyboard shown here is an image for your reference. Different keys may be enabled depending on the actual situation and condition under which you enter characters.

 If "External Keyboard" is selected in "Settings" → [System Settings] → [Common Settings] → [Keyboard Settings] → [Default Keyboard Setting] → [Set Keyboard Priority], the soft keyboard will not appear.

 **To register words:**
In "Settings (administrator)", select [System Settings] → [Common Settings] → [Keyboard Settings] → [Soft Keyboard Template Setting].

SET THE KEYBOARD SETTING

In "Settings (administrator)", select [System Settings] → [Common Settings] → [Operation Settings] → [Keyboard Settings].

Keyboard Settings

Default Keyboard Setting

Configure settings for the keyboard used for entry on the text.

Keyboard Select

Change the key layout and display according to the set language.

Set Keyboard Priority

When an external keyboard is connected, set whether the external keyboard or the keyboard shown on the touch panel (soft keyboard) is given priority.

Soft Keyboard Template Setting

Register a text that you frequently use when entering an address or domain name in advance. Enter a maximum of 16 characters.

SHARP[®]
SHARP CORPORATION