

SHARP®

ELECTRONIC CASH REGISTER
CAJA REGISTRADORA ELECTRONICA

MODEL
MODELO **XE-A42S**

INSTRUCTION MANUAL

MANUAL DE INSTRUCCIONES



WARNING

FCC Regulations state that any unauthorized changes or modifications to this equipment not expressly approved by the manufacturer could void the user's authority to operate this equipment.

Note: This equipment has been tested and found to comply with the limits for a Class A digital device, pursuant to Part 15 of the FCC Rules. These limits are designed to provide reasonable protection against harmful interference when the equipment is operated in a commercial environment.

This equipment generates, uses, and can radiate radio frequency energy and, if not installed and used in accordance with the instruction manual, may cause harmful interference to radio communications. Operation of this equipment in a residential area is likely to cause harmful interference in which case the user will be required to correct the interference at his own expense.

CAUTION

The AC power socket-outlet should be installed near the equipment and should be easily accessible.

FOR YOUR RECORDS

Please record below the model number and serial number for easy reference in case of loss or theft. These numbers are located on the right side of the unit. Space is provided for further pertinent data.

Model Number _____

Serial Number _____

Date of Purchase _____

Place of Purchase _____

INTRODUCTION

Thank you very much for your purchase of the SHARP Electronic Cash Register, Model XE-A42S. Please read this manual carefully before operating your machine in order to gain full understanding of functions and features. Please keep this manual for future reference. It will help you if you encounter any operational problems.

CAUTION!

Be sure to initialize the cash register before you start operating the cash register. Otherwise, distorted memory contents and malfunction of the cash register will occur. For this procedure, please refer to page 7.

IMPORTANT

- **On the printer, a paper cutter is mounted. Be careful not to cut yourself on the paper cutter.**
- **Install your register in a location that is not subject to direct radiation, unusual temperature changes, high humidity or exposed to water sources.**
Installation in such locations could cause damage to the cabinet and the electronic components.
- **Never operate the register with wet hands.**
The water could seep into the interior of the register and cause component failure.
- **When cleaning your register, use a dry, soft cloth. Never use solvents, such as benzine and/or thinner.**
The use of such chemicals will lead to discoloration or deterioration of the cabinet.
- **The register plugs into any standard wall outlet (120V AC \pm 10%).**
Other electrical devices on the same electrical circuit could cause the register to malfunction.
- **If the register malfunctions, call 1-800-BE-SHARP for service - do not try to repair the register yourself.**
- **For complete electrical disconnection, disconnect the main plug.**

PRECAUTION

This Electronic Cash Register has a built-in memory protection circuit which is operated by rechargeable batteries.

As you know, all batteries will, in time, dissipate their charge even if not used. Therefore to insure an adequate initial charge in the protection circuit, and to prevent any possible loss of memory upon installation, it is recommended that each unit be allowed to recharge for a period of 24 to 48 hours prior to use.

In order to charge the batteries, the machine must be plugged in and the mode switch must be in a position other than "OFF". This recharging precaution can prevent unnecessary initial service calls.

**Customer Service Hotline
1-800-BE-SHARP**

**For Easy Set-up, see
"GETTING STARTED" (page 7).**

**The Spanish version (summary of English version) is after the English version.
La versión española (el resumen de la versión inglesa) sigue a la versión inglesa.**

CONTENTS

INTRODUCTION	1
IMPORTANT	1
PRECAUTION	1
CONTENTS	2
PARTS AND THEIR FUNCTIONS	4
1 External View	4
2 Printer	4
3 Mode Switch and Mode Keys	5
4 Keyboard	5
5 Displays	6
6 Drawer Lock Key	6
GETTING STARTED	7
HELP FUNCTION	11
<FOR THE OPERATOR>	
OVERVIEW OF FLOW OF DAILY SALES ENTRIES	12
BASIC SALES ENTRY	13
1 Basic Sales Entry Example	13
2 Error Warning	14
3 Item Entries	15
Single item entries	15
Repeat entries	17
Multiplication entries	17
Split pricing entries	18
Single item cash sale (SICS) entry	19
PLU/UPC price inquiry (view) function	19
UPC learning function	20
4 Displaying Subtotals	21
5 Finalization of Transaction	21
Cash or check tendering	21
Cash or check sale that does not require tender entry	22
Charge (credit) sale	22
Mixed-tender sale	22
6 Tax Calculation	23
Automatic tax	23
Manual tax	23
Tax delete	23
Tax status shift	24
OPTIONAL FEATURES	24
1 Auxiliary Entries	24
Discount and premium entries using the percent key	24
Discount and premium entries using the discount key	25
Refund entries	26
Non-add code number entries and printing	26
2 Auxiliary Payment Treatment	27
Currency conversion	27
Received-on account and paid-out entries	28
No sale (exchange)	28
Bottle return	28
3 Automatic Sequence Key (AUTO key) Entries	28
CORRECTION	29
1 Correction of the Last Entry (direct void)	29
2 Correction of the Next-to-last or Earlier Entry (indirect void)	29
3 Subtotal Void	30
4 Correction of Incorrect Entries not Handled by the Direct or Indirect Void Function	30
<FOR THE MANAGER>	
PRIOR TO PROGRAMMING	31
BASIC FUNCTION PROGRAMMING (For Quick Start)	31

1	Date and Time Programming	31
2	Tax Programming for Automatic Tax Calculation Function	32
	Tax programming using a tax rate	32
	The tax table (applicable to the add-on tax)	33
AUXILIARY FUNCTION PROGRAMMING		36
1	Department Programming	36
2	PLU/UPC Programming	38
3	Commission Rate Programming	39
4	Miscellaneous Key Programming	40
	Rate for %1, %2 and CLK#CONV (When using as CONV key)	40
	Amount for ⊖	41
	Percent rate limitation for %1 and %2	41
	Function parameters for %1, %2 and ⊖	41
	Function parameters for CLK#CONV	42
	Entry digit limit for RA/AMT (When using as RA key), RCPT/PO (When using as PO key) and TAX	43
	Function parameters for CHK, CH1, CH2 and CA/AT/NS (when using as CA key)	43
5	Text Programming	44
ADVANCED PROGRAMMING		52
1	Register Number and Consecutive Number Programming	52
2	Various Function Selection Programming 1	52
	Function selection for miscellaneous keys	53
	Print format	53
	Receipt print format	54
	Function selection for tax	54
	Function selection for UPC codes	54
	Other programming	55
3	Various Function Selection Programming 2	56
	Power save mode	56
	Logo message print format	57
	High amount lockout (HALO) for cash in drawer (CID) (sentinel)	57
	Online time out setting	57
	Thermal printer density	58
	Language selection	58
	Training clerk specification for training mode	58
	AUTO key programming	59
4	Reading Stored Programs	59
TRAINING MODE		61
READING (X) AND RESETTING (Z) OF SALES TOTALS		62
OVERRIDE ENTRIES		68
CORRECTION AFTER FINALIZING A TRANSACTION (Void mode)		68
HOW TO USE AN SD MEMORY CARD		69
1	What You Can Do with an SD Memory Card	69
2	In Case of SD Error	70
3	Inserting and Removing an SD Memory Card	71
4	Formatting an SD Memory Card	71
5	Saving and Restoring All the Data	72
6	Writing and Reading of Programming Data	72
7	Writing of Sales Data	73
OPERATOR MAINTENANCE		74
1	In Case of Power Failure	74
2	In Case of Printer Error	74
3	Cautions in Handling the Printer and Recording Paper	74
4	Replacing the Paper Roll	75
5	Removing a Paper Jam	77
6	Cleaning the Print Head	77
7	Removing the Till and the Drawer	78
8	Opening the Drawer by Hand	78
9	Before Calling for Service	79
	Error message table	79
SPECIFICATIONS		80

PARTS AND THEIR FUNCTIONS

1 External View

Register front view

Operator display

Printer cover

Receipt paper

Journal window

Keyboard

Drawer lock

Drawer

Register rear view

Customer display
(Pop-up type)

AC power cord

Mode switch

SD card slot
(Refer to page 71.)

USB port

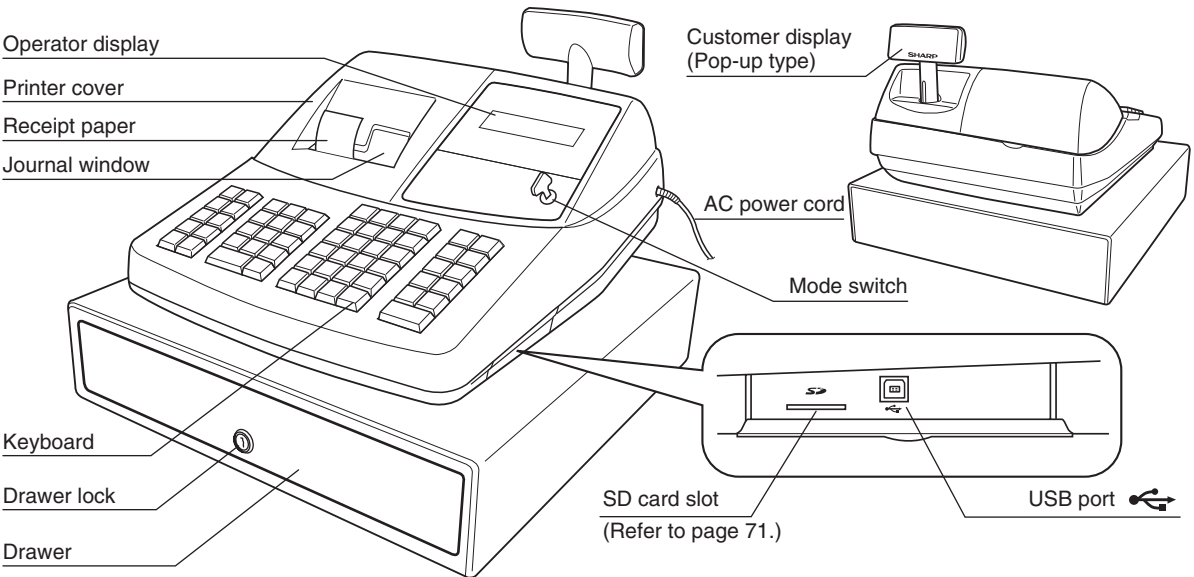

Note Use only the USB cable supplied with the XE-A42S for the connection with a PC. Never use other cables.

2 Printer

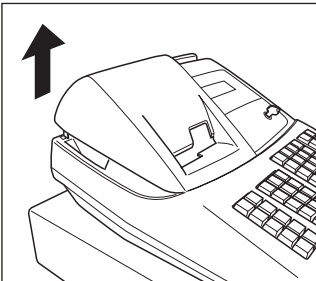

The printer is a receipt/journal dual station type thermal printer, and therefore it does not require any type of ink ribbon or cartridge.

Lift the rear of the printer cover to remove. To re-install, hook the pawls on the cabinet and close.

Caution: The paper cutter is mounted on the printer (receipt side). Be careful not to cut yourself.

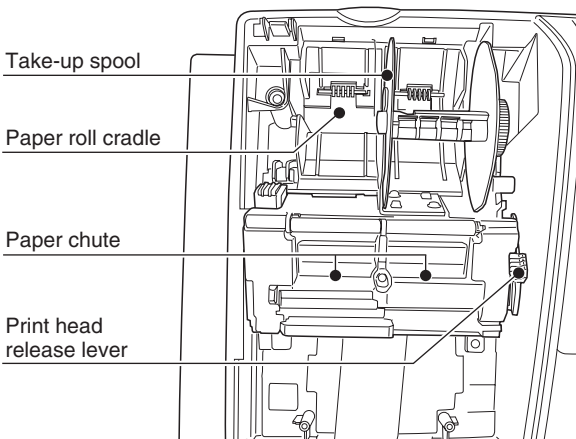

Print head release lever

The print head can be lifted by the green lever on the right side of the printer. Pulling the lever forward lifts up the print head. If the paper becomes jammed and you need to move the head farther forward, you can pull the lever even further toward you and proceed with the removal of the jammed paper.

Note Do not attempt to remove the paper roll with the head in the down position. This may result in damage to the printer and print head.

3 Mode Switch and Mode Keys

The mode switch can be operated by inserting supplied mode key - manager (MA) and operator (OP) keys. This key can be inserted or removed only in the "REG" or "OFF" position.

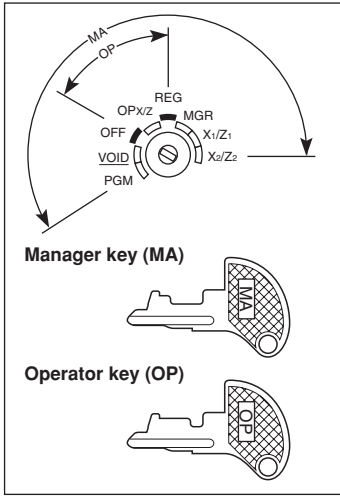

The mode switch has these settings:

- OFF:** This mode locks all register operations. (AC power turns off.) No change occurs to register data.
- OP X/Z:** To take individual clerk X or Z reports, and to take flash reports. It can be used to toggle receipt state "ON" and "OFF" by pressing the **RCPT/PO** key.
- REG:** For entering sales.
- PGM:** To program various items.
- VOID:** Enters into the void mode. This mode allows correction after finalizing a transaction.
- MGR:** For manager's entries. The manager can use this mode for an override entry.
- X1/Z1:** To take the X/Z report for various daily totals
- X2/Z2:** To take the X/Z report for periodic (weekly or monthly) consolidation

4 Keyboard

Keyboard layout

RECEIPT ↑	JOURNAL ↑	@/FOR	•	CL	PLU /SUB 25 5 A	DEPT # 30 10 F	DEPT SHIFT 35 15 K	CLK# /CONV 40 20 P	INQ U	AUTO X
RA /AMT !	%1 /	7	8	9	24 4 B	29 9 G	34 14 L	39 19 Q	TAX1 SHIFT V	TAX2 SHIFT Y
RCPT /PO _	%2 NUMBER	4	5	6	23 3 C	28 8 H	33 13 M	38 18 R	TAX W	CH1 Z
VOID DC	RFND SHIFT	1	2	3	22 2 D	27 7 I	32 12 N	37 17 S	CHK	CH2
ESC /HELP BS	SPACE	0	00		21 1 E	26 6 J	31 11 O	36 16 T	MDSE SBTL	#/TM SBTL
									CA/AT/NS	

Note

- To distinguish from other keys, 0 ~ 9, 00, @/FOR, • and CL are represented as not square-shaped keys but round-shaped keys in this manual.
- The small characters on the bottom or lower right in each key indicates functions or characters which can be used for character entries for text programming. For details, refer to page 44.

Key names

RECEIPT ↑	Receipt paper feed key	@/FOR	Multiplication key	INQ	Inquiry key
JOURNAL ↑	Journal paper feed key	•	Decimal point key	TAX1 SHIFT TAX2 SHIFT	Tax 1 and 2 shift keys
RA /AMT !	Received-on account /Amount key	CL	Clear key	AUTO	Automatic sequence key
RCPT /PO _	Receipt print/Paid-out key	00	0 ~ 9	TAX	Tax key
VOID	Void key	PLU /SUB	PLU/Sub-department key	CHK	Check key
ESC /HELP	Escape/Help key	DEPT #	Department code entry key	CH1 CH2	Charge 1 and 2 keys
%1 %2	Percent 1 and 2 keys	DEPT SHIFT	Department shift key	MDSE SBTL	Merchandise subtotal key
RFND	Refund key	CLK# /CONV	Clerk code entry /Conversion key	#/TM SBTL	Non-add code/Time display /Subtotal key
SPACE	Discount key	1 ~ 20	Department keys	CA/AT/NS	Total/Amount tender /No sale key

5 Displays

Operator display

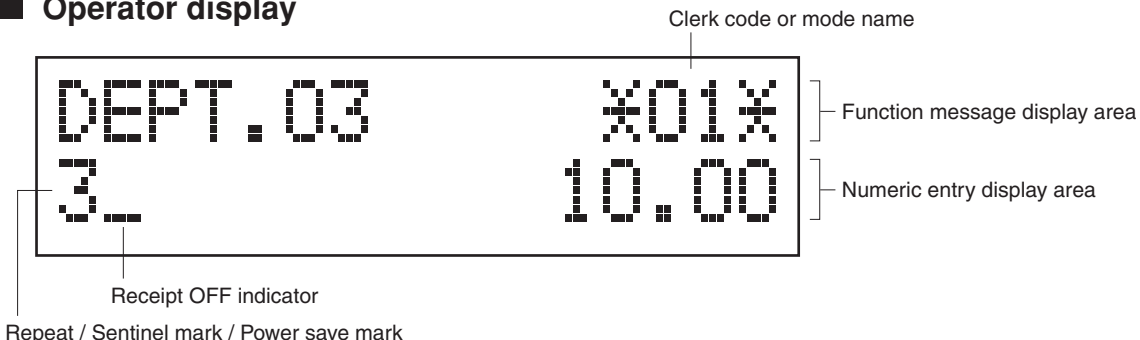

• Clerk code or Mode name

The mode you are in is displayed. When a clerk is assigned, the clerk code is displayed in the REG or OP X/Z mode. For example, "*01*" is displayed when clerk 01 is assigned.

• Repeat

The number of repeats is displayed, starting at "2" and incremental with each repeat. When you have registered ten times, the display will show "0". (2 → 39 → 0 → 1 → 2...)

• Sentinel mark

When amount in the drawer reaches the amount you preprogrammed, the sentinel mark "X" is displayed to advise you to remove the money to a safe place.

• Power save mark

When the cash register goes into the power save mode, the power save mark (decimal point) lights up.

• Function message display area

Item labels of departments and PLU/UPCs and function texts you use, such as %1, (-) and CASH are displayed. For the details of function texts, please refer to pages 48 and 49.

When an amount is to be entered, ----- is displayed at the numeric entry area with a guidance message "ENTER PRICE".

• Numeric entry display area

Numbers entered using numeric keys are displayed here.

Date and time display

Date and time appear on the display in the OP X/Z, REG, or MGR mode. In the REG or MGR mode, press the key to display the date and time.

Backlight of the LCD display

When an error occurs or the or key is pressed or enter the void mode, the green backlight will turn red.

Error message

When an error occurs, the corresponding error message is displayed in the function message display area. For details of error messages, please refer "Error message table" on page 79.

Customer display (Pop-up type)



6 Drawer Lock Key

This key locks and unlocks the drawer. To lock it, turn 90 degrees counterclockwise. To unlock it, turn 90 degrees clockwise.

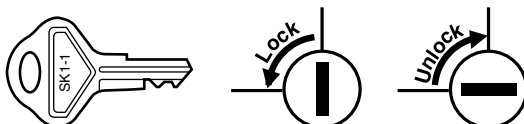

GETTING STARTED

Please follow the procedure shown below.

1

Installing the cash register

Find a stable surface near an AC outlet where the cash register will not be subject to water sources or direct sunlight .

Unpack the cash register and make sure all accessories are included. For details of accessories, please refer to “Specifications” section.



2

Initializing the cash register

In order for the cash register to operate properly, you must initialize it before operating for the first time. Follow this procedure.

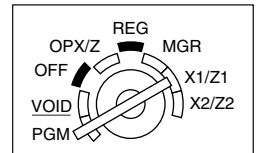
1. Make sure the power cord plug is **not** inserted into the AC outlet.
2. Insert the manager (MA) key into the mode switch and turn it to the PGM position.



3. While holding down both the  key and the  key, insert the plug into the AC outlet. The buzzer will sound three times and “*** MRS. ***” will be displayed.
4. The cash register has now been initialized. The register display will now show “0.00” with “PGM”.

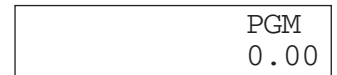
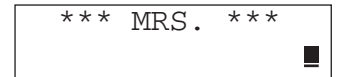

Note

If the buzzer does not sound when the plug is inserted, the initialization has not been done successfully. (This will occur when the voltage is high because you operated the cash register before starting initialization.) Wait at least ten seconds after pulling out the plug and initialize the cash register again.

Caution

The cash register has a built-in memory protection circuit which is operated by rechargeable batteries. Since the rechargeable batteries have been discharged, please charge the batteries for one or two days before using the cash register for the first time. To charge the batteries, set the mode switch to a position other than “OFF” with the power cord plugged into the AC outlet. Unless the batteries have been charged, all of the programmed data and sales data are not saved.

Note

If you press a key by mistake, an error message such as “HEAD UP” or “PAPER EMPTY” may be displayed. Press the  key to clear message after installing paper rolls.

3

Preparing the cash register

To make the cash register ready for operation, remove the retainer and set the print head release lever in print position.

1. Push the printer cover forward and detach it.
2. Remove the white retainer at the position shown at the right. Please keep this retainer for future use when transferring the cash register.
3. Move the print head release lever to the printing position as illustrated at the right.

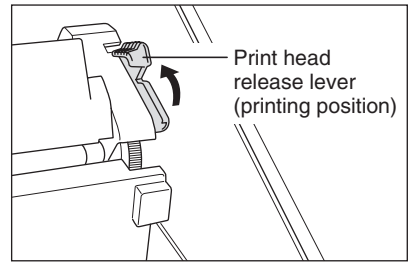
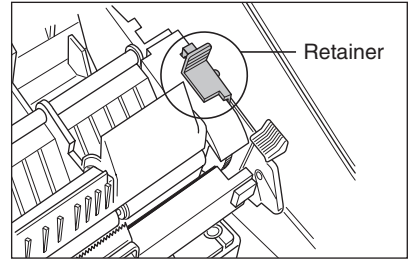

4

Installing paper rolls

Precaution: The paper cutter is mounted on the printer (receipt side). Take caution when installing paper rolls.

The register can print receipts and journals. For the printer, you must install the paper rolls (receipt and journal paper rolls) provided with the register.

Install the paper rolls according to the procedure shown below with the power cord connected and the mode switch set to the PGM position:

How to cut a paper roll and set it in the paper roll cradle:

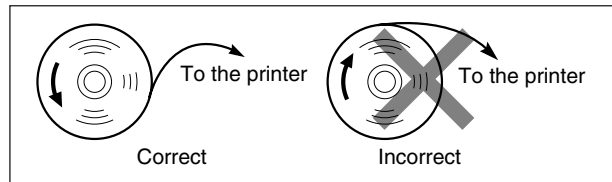
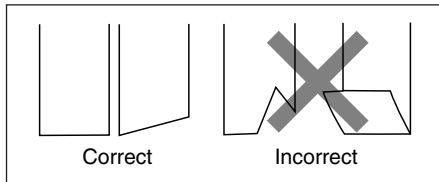



Note

When setting a new paper roll in the paper roll cradle, be sure to cut the paper end behind the taped (or pasted) point in advance.

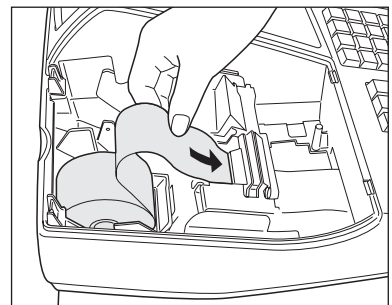
1. Cut off approximately one revolution of each paper roll. Make sure each paper end is cut as illustrated above.
2. Set a paper roll in the paper roll cradle of the receipt side as illustrated above.
3. Insert the end of the paper roll into the paper chute until it is caught by the printer auto-feed and comes out of the top of the printer. If the printer does not catch the paper, feed the paper while pressing the  key.
4. Cut off excess paper with the paper cutter.



5. Set a paper roll in the paper roll cradle of the journal side.
6. Insert the end of the paper into the paper chute of the printer until it is caught by the printer auto-feed and comes out of the top of the printer. If the printer does not catch the paper, feed the paper while pressing the  key.
7. Insert the end of the paper into the slit in the take-up spool and fold the paper to front side. (Press the  key to feed more paper if required.)
8. Wind the paper two or three turns around the spool shaft.
9. Set the spool on the bearing, and press the  key to take up excess slack in the paper.
10. Replace the printer cover.

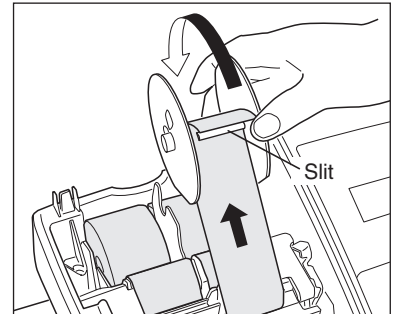

5 Programming date, time and tax

Note

The cash register provides text languages of English and Spanish. It is preset to English. If you want to change the language, you must change it before programming. Refer to "Language selection" in "Various Function Selection Programming 2" section for changing the language.

Before you can proceed with registration of sales, **you must program:**

- date
- time
- tax

Please refer to the BASIC FUNCTION PROGRAMMING section for details (page 31).

6 Programming other necessary items

While the cash register is pre-programmed to be used with minimal setup, it does provide you with optional functions. Before you start programming, please read through the sales operations section to understand optional functions. The main optional functions are listed below:

- PLU (price lookup)/sub-department
- UPC/EAN
- Consecutive number
- Machine number
- Power save mode (factory setting: goes into power save mode after 30 minutes)
- Text programming for clerk name, department items, PLU/sub-department and UPC/EAN items, logo messages printed on the top or bottom of receipts, function texts and foreign currency symbol
- Bottle return department
- Split pricing entry
 - This is not factory preset. You must enable this function.
- Foreign currency conversion rate
 - You must set a conversion rate to use the conversion key.
- Preset unit price for departments, PLU/UPC/EANs
- Preset amount for 

- Preset rates for

You do not have to program these preset prices/amount/rates since they can be entered at registration.

- Amount entry digit limit for PO amount, RA amount, Manual tax amount
The factory setting makes the maximum amount you can enter. You can program to limit the amount.
- Sentinel - High amount lockout (HALO) for cash in drawer (CID)
- Department group
You can classify departments into a maximum of 9 groups (0 to 9 groups: 0: non-group is assigned). Sales in each group can later be printed on an individual group total report and full group total report.
- Commission
If you program commission rate (up to two) and classify departments (For PLU/sub-department/UPC/EANs, their commission rates are tracked by their associated departments.) into commission groups (0 to 2 groups: 0: non-commission), commission sales and amount in each commission group can later be printed on an individual and full clerk report.
- Key sequence for AUTO key
- Online time out setting
- Specification of clerk to be trained

Department programming:

The cash register is pre-programmed for departments as follows:

Department: Allow open price entry in normal department (group: 0, commission group: 0), taxable status-taxable 1 for department 1 to 10, and non taxable for department 11 to 99

When you use department 11 or above, and/or you apply taxable status other than taxable 1 for department 1 to 10, you must change department settings. Please refer to the department programming section for programming details.

7

Starting sales entries

Now you are ready for sales registration.

HELP FUNCTION

The help function allows you to print guidance messages for setup and some operations of the cash register. This function is available in any mode switch position other than "OFF".

■ Printing the help menu

Press the **ESC/HELP** key to print the help menu. This menu provides the list of operations, which can print the guidance message from the help function.

Key operation	Print
ESC/HELP	<pre>HELP MENU 1-[HELP]: DATE/TIME --- 1 DATE/TIME SETUP 2-[HELP]: TAX --- 2 TAX RATE SETUP 3-[HELP]: DEPARTMENT --- 3 DEPARTMENT PRICE&TEXT 4-[HELP]: SALES Z REPORT --- 4 SALES Z REPORT 5-[HELP]: LOGO --- 5 LOGO SETTING 6-[HELP]: RECEIPT --- 6 RECEIPT ISSUE 7-[HELP]: "NOT ASSIGNED" --- 7 "NOT ASSIGNED" DISPLAY IN THE DISPLAY 8-[HELP]: SD CARD --- 8 SD CARD COMMAND 9-[HELP]: PC S/W INSTALL --- 9 INSTALL PC SOFTWARE ----- OTHER ISSUE: PLEASE CALL 1-800-BE-SHARP</pre>

■ Printing guidance messages

By referencing the help menu above, press the corresponding numeric key and then the **ESC/HELP** key to print the guidance message for each operation.

Key operation example	Print
1 ESC/HELP	<pre>1 DATE/TIME SETUP (PGM MODE) DATE:XXXXXXXX-[SBTL] YYYYMMDD OR DDMMYYYY OR MMDDYYYY (DEFAULT) TIME:HHMM-[SBTL] (0000-2359) EX) 08/01/2006 PM4:30 (DATE FORMAT=M-D-Y) 08012006-[SBTL] 1630-[SBTL]</pre> <p>Sample print of DATE/TIME SETUP</p>

Note

The **ESC/HELP** key works as the error escape function during a transaction. Finalize the transaction to use the key as the help function.

OVERVIEW OF FLOW OF DAILY SALES ENTRIES

Things to do before starting sales entries:

- Make sure the power cord is securely connected to the AC outlet.
- Turn the mode switch to OP X/Z position and check if date and time are correctly set.
- Replace the till, if removed for safety.
- Check if there is enough paper on each roll.
- Select receipt ON/OFF function.
- Make any necessary programming for the day in PGM mode.

For details, refer to BASIC SALES ENTRY, page 13. For the till and paper roll, refer to OPERATOR MAINTENANCE, page 74 and for programming, refer to programming sections.

Things you can do for sales entries:

- Item entries
- Item repeat entries
- Item multiplication entries
- Single item cash sale (SICS), if programmed.
- Split pricing entries, if programmed.
- Displaying subtotals
- Cash/Check/Charge sale
- Cash tendering in a foreign currency, if the currency conversion rate is programmed.
- Manual tax entry
- Discount or premium using and key
- Refund entry
- No sale
- Paid-out entries
- Received on account entries
- Printing non-add code number
- Making corrections
- Checking sales reports

For details of sales entry method, refer to BASIC SALES ENTRY (page 13) and OPTIONAL FEATURES (page 24) sections and for details of correcting sales entries, refer to CORRECTION (page 29) section. For details of reading sales information, refer to READING (X) AND RESETTING (Z) OF SALES TOTAL (page 62) section.

Things to do after close of business:

- Print sales reports, and clear sales data for the day.
- Account money - comparing it with the amount of cash in drawer versus the amount printed on the general report.
- Remove the till for safety.
- Turn the mode switch to OFF position.

For details of reading sales information, refer to READING (X) AND RESETTING (Z) OF SALES TOTAL (page 62) section. For details of removing the till and maintenance details, refer to OPERATOR MAINTENANCE (page 74) section.

BASIC SALES ENTRY

1 Basic Sales Entry Example

Listed below is a basic sales entry example when selling items by cash. For operation details, please refer to each section.

Mode switch setting

1. Turn the mode switch to the REG position.

Clerk assignment

2. Enter your clerk code. (For example, clerk code is 1. Press the **1** and **CLK#/CONV** key in this order.)

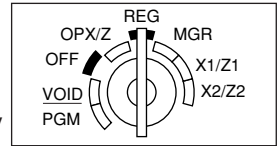

Item entries

3. Enter the price for the first department item. (For example, for 15.00, enter **1** **5** **00**, and press the appropriate department key).
 For department 21 to department 40, press the **DEPTSHIFT** key first before pressing the department key.
 For department 41 and above, enter the department code using numeric keys, and press the **DEPT#** key, then enter the price and press the **DEPT#** key again.

4. Repeat step 3 for all department items.

Displaying subtotals

5. Press the **#TWSBTL** key to display the amount due.

Finalizing the transaction

6. Enter the amount received from the customer. (You can omit this step if the amount tendered is the same as the subtotal.)
7. Press the **CA/AT/NS** key, and the change due is displayed (when the amount received was not entered, the total amount is displayed) and the drawer is opened.
8. Tear off the receipt and give it to the customer with his or her change.
9. Close the drawer.

Key operation example

Clerk assignment	→ 1 CLK#/CONV	CLERK01 *01* -01-
Item entries	{ 1500 1 ²¹	DEPT. 01 *01* 15.00
		{ 2300 2 ²²
Displaying subtotal	→ #TWSBTL	SUBTOTAL *01* 40.38
	5000	*01* 5000
Finalizing the transaction	→ CA/AT/NS	CHANGE *01* 9.62

(In this example, the tax rate is set to 6.25%.)

Receipt print

YOUR RECEIPT		} Graphic logo
THANK YOU		
01/26/2010 4:03PM 01		— Date/Time/Clerk code
123456#1091 DAVID		— Register number /Consecutive number/Clerk name
		— Items
DEPT. 01	T1 \$15.00	— Price
DEPT. 02	T1 \$23.00	} Merchandise subtotal
MDSE ST	\$38.00	
TAX1	\$2.38	— Tax amount
		— Tax status (T1: taxable 1)
ITEMS	20	— Total quantity
***TOTAL	\$40.38	— Total amount
CASH	\$50.00	— Cash tendering/amount received
CHANGE	\$9.62	— Change

Clerk assignment

Prior to any item entries, clerks must enter their clerk codes into the register. However, the code entry may not be necessary when the same clerk handles consecutive transactions.

■ Sign-on (in REG, MGR, VOID mode)

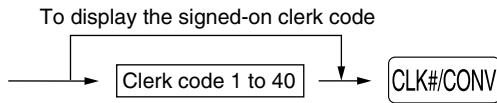

■ Sign-off (in REG, MGR, VOID mode)



Receipt ON/OFF function

You can disable receipt printing in the REG mode to save paper using the receipt ON/OFF function. To disable receipt printing, press the **RCPT/PO** key in the OP X/Z position. This key toggles the receipt printing status ON and OFF.

To check the receipt printing status, turn the mode switch to the OP X/Z position or press the **CL** key in the REG mode. When the function is in the OFF mode, the receipt off indicator “_” illuminates.

The register will print reports regardless of the receipt state, so the paper roll must be installed.

To issue a receipt when receipt ON/OFF function is set to OFF:

If your customer wants a receipt after you finalized a transaction with the receipt ON/OFF function in the OFF mode, press the **RCPT/PO** key. This will produce a receipt. If more than 50 items were entered, the receipt will be issued in a summary receipt format. Your register can also print a copy receipt when the receipt ON/OFF function is in the “ON” status.

Power Save Mode

The register will enter into power save mode when no entries are performed based on the pre-programmed time limit (by default, 30 minutes).

When the register goes to the power save mode, all display lights will turn off except the decimal point at the leftmost position of the lower line. The register will return to normal operation mode when any key is pressed or a mode is changed with the mode key. Please note when the register is recovered by a key entry, its key entry is invalid. After the recovery, start the key entry from the beginning.

2 Error Warning

In the following examples, your register will go into an error state accompanied with a warning beep and a corresponding error message. Clear the error state by pressing the **CL** key and take proper action. Please refer to the error message table on page 79.

- Enter over a 32-digit number (entry limit overflow): Cancel the entry and re-enter the correct number.
- An error in key operation: Clear the error and continue operation.
- An entry beyond a programmed amount entry limit: Check to see if the entered amount is correct. If it is correct, it can be rung up in the MGR mode. Contact your manager.
- An including-tax subtotal exceeds eight digits: Delete the subtotal by pressing the **CL** key and press the **CA/AT/NS**, **CHK**, **CH1** or **CH2** key to finalize the transaction.

Error escape function

To quit a transaction due to an error or an unforeseen event, use the error escape function as shown below:

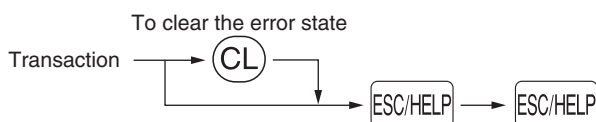

The transaction is voided (treated as a subtotal void) and the receipt is issued by this function. If you have already entered a tendered amount, the operation is finalized as a cash sale.

3 Item Entries

Single item entries

Department entries

For a merchandise classification, the cash register provides a maximum of 99 departments. To the departments, group attributes such as taxable status are applied to items when they are entered.

• When using the department keys (for department 1 to 40)

For department 1 to 20, enter a unit price and press a department key. If you use a programmed unit price, press a department key only.

For department 21 to 40, enter a unit price, press the **DEPTSHIFT** key and press a department key. If you use a programmed unit price, press the **DEPTSHIFT** key and press a department key.

When using a programmed unit price

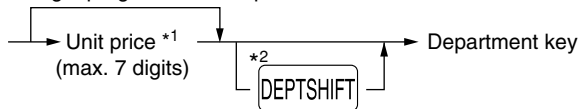

*1 Less than the programmed upper limit amounts
When zero is entered, only the sales quantity is added.

*2 For the departments 21 through 40, press the department shift key.

Note

Please note if you press the same key after using the **DEPTSHIFT** key, it acts as a repeat entry. For example, when you register an item of dept. 21 using the **DEPTSHIFT** key and then an item of dept. 1 using the preset unit price, you should use the department code entry key described below for the dept. 1 item. If you just press the **1** key to register dept. 1 item, it will act as a repeat entry of dept. 21 item.

• When using the department code entry key

Enter a department (dept.) code and press the **DEPT#** key, then enter a unit price and press the **DEPT#** key again. If the dept. code is programmed to preset price entry style and a unit price is preset, the cash register will finish its registration operation.

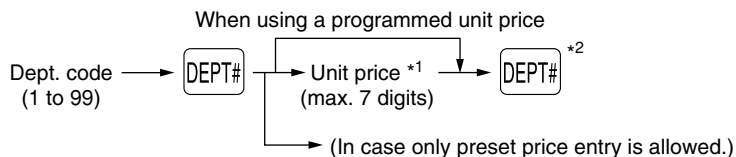

*1 Less than the programmed upper limit amounts
When zero is entered, only the sales quantity is added.

*2 After you enter a unit price, you can press the **RA/AMT** key instead of the **DEPT#** key.

PLU/sub-department entries

For another merchandise classification, the cash register provides a maximum of 7000* PLUs/sub-departments. PLUs are used to call up preset prices by a code entry. Sub-departments are used to classify merchandise into smaller groups under the departments. Every PLU and sub-department has a code from 1 to 7000, and should belong to a department to obtain attributes of that department.

The cash register is pre-programmed to PLU mode and zero for unit price. To use PLU entries, their preset unit prices should be previously programmed. (Refer to page 38.)

To use sub-department entries, change to sub-department mode for the PLU codes.

*A total of 7000 codes, including UPC codes, can be programmed.

• PLU entries



• **Sub-department (open PLU) entries**

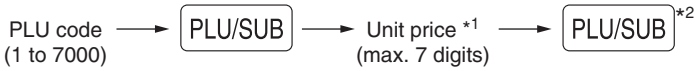

*1 Less than the programmed upper limit amounts

When zero is entered, only the sales quantity is added.

*2 After you enter a unit price, you can press the **RA/AMT** key instead of the **PLU/SUB** key.

Note You can display preset unit prices during sales operations. If you are a manager, that is, you have a MGR key, you can temporarily change preset prices. For operation details, please refer to "PLU/UPC price inquiry (view) function" on page 19.

• **UPC (barcode) entries**

You can keyboard barcodes. The barcodes which can be keyboarded are UPC-A (number system character: 0,2,3,4,5), UPC-E, EAN-8 and EAN-13. You can also keyboard add-on codes (2 digits or 5 digits) added to EAN-13 codes except ISBN and ISSN codes.

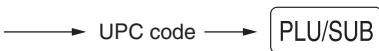

- Note**
- When programmed not to allow price entry for ISBN and ISSN codes (job code #16), you cannot enter ISBN and ISSN codes.
 - You can display preset unit prices during sales operations. If you are a manager, that is, you have a MGR key, you can temporarily change preset prices. For operation details, please refer to "PLU/UPC price inquiry (view) function" on page 19.
 - The cash register refers to preset prices, not referring to price information in barcodes. By default, when a preset price is not preprogrammed, the cash register goes into UPC learning function status to guide you to enter unit price and other necessary information during sales operation. For details of UPC learning function, please refer to "UPC learning function" on page 20.

Example: Selling a dept. 12 item (\$12.00), a dept. 21 item (\$5.00), a dept. 14 item (using preset price), a dept. 22 item (using preset price), and a dept. 50 item (\$15.00), a dept. 41 item (using preset price), a PLU 2 item (PLU entry), a PLU 11 item (sub-dept. entry, \$12.00) and UPC code 323456789108 item (label: COFFEE/\$3.60)

Key operation example

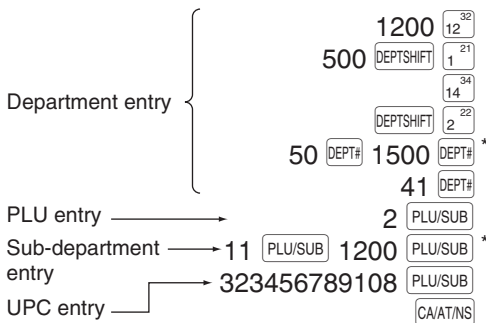

Receipt print

DEPT. 12	\$12.00
DEPT. 21	\$5.00
DEPT. 14	\$8.25
DEPT. 22	\$3.25
DEPT. 50	\$15.00
DEPT. 41	\$2.50
PLU0002	\$1.50
PLU0011	\$12.00
COFFEE	\$3.60
ITEMS	90
CASH	\$63.10

*Use of the **RA/AMT** key is available instead of the last **DEPT#** or **PLU/SUB** key.

Note

When printing of Dept./PLU/UPC codes is allowed, job code #16, each code is printed as follows:

D41		Dept. code
DEPT. 41	\$2.50	
P0002		PLU code
PLU0002	\$1.50	
P0011		
PLU0011	\$12.00	
323456789108#		UPC code
COFFEE	\$3.60	

Repeat entries

You can use this function for entering a sale of two or more of the same items. Consecutive pressing of a department key, [DEPT#], [PLU/SUB] key or [RA/AMT] key is shown below.

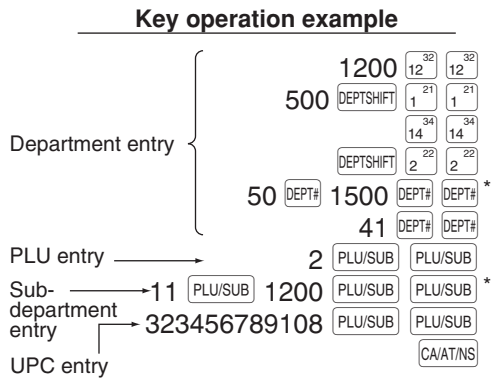

Receipt print

DEPT. 12	\$12.00
DEPT. 12	\$12.00
DEPT. 21	\$5.00
DEPT. 21	\$5.00
DEPT. 14	\$8.25
DEPT. 14	\$8.25
DEPT. 22	\$3.25
DEPT. 22	\$3.25
DEPT. 50	\$15.00
DEPT. 50	\$15.00
DEPT. 41	\$2.50
DEPT. 41	\$2.50
PLU0002	\$1.50
PLU0002	\$1.50
PLU0011	\$12.00
PLU0011	\$12.00
COFFEE	\$3.60
COFFEE	\$3.60
ITEMS	180
CASH	\$126.20

*Consecutive pressing of [RA/AMT] key is required when [RA/AMT] key is used after price entry.

Multiplication entries

When selling a large quantity of items, it is convenient to use the multiplication entry method. Enter the quantity using numeric keys and press the [e/FOR] key before starting item entry as shown in the example on the following page.

Note

When programmed to allow fractional quantity entries, you can enter up to four integers and three digit decimal, though the quantity is counted as one for sales reports. To enter a fractional quantity, use the decimal point key between integer and decimal, as (7)•(5) for entering 7.5.

Key operation example

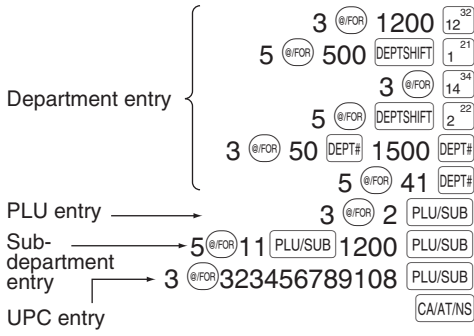

Receipt print

	3 @	\$12.00
DEPT. 12		\$36.00
	5 @	\$5.00
DEPT. 21		\$25.00
	3 @	\$8.25
DEPT. 14		\$24.75
	5 @	\$3.25
DEPT. 22		\$16.25
	3 @	\$15.00
DEPT. 50		\$45.00
	5 @	\$2.50
DEPT. 41		\$12.50
	3 @	\$1.50
PLU0002		\$4.50
	5 @	\$12.00
PLU0011		\$60.00
	3 @	\$3.60
COFFEE		\$10.80
ITEMS	35Q	
CASH		\$234.80

Split pricing entries

This function is practical when the customer wants to purchase items normally sold in bulk.

To utilize this function, you must change the pre-programmed or default programmed setting. Refer to "Various Function Selection Programming 1" (job code 70) for programming details.

To make split pricing entries, follow the procedure below:

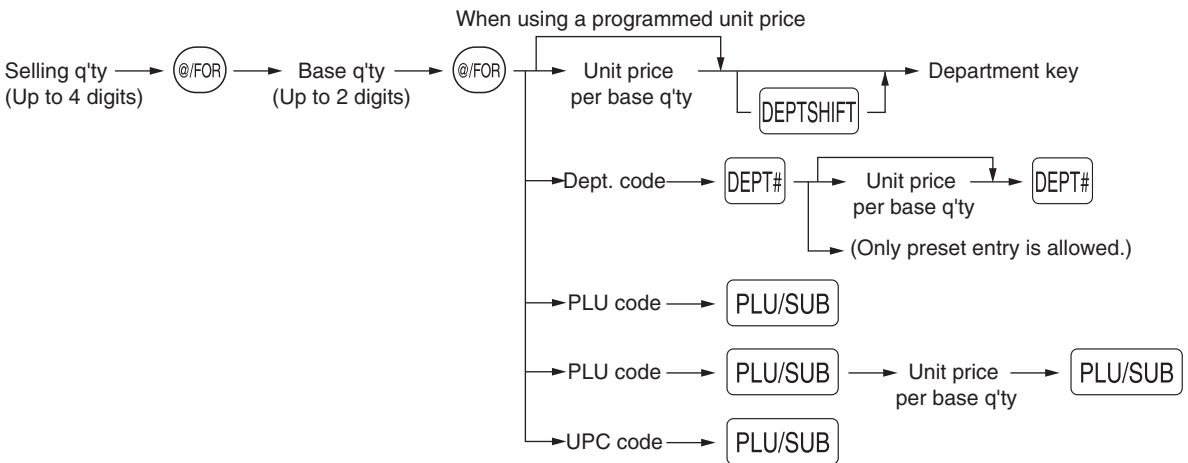

Key operation example

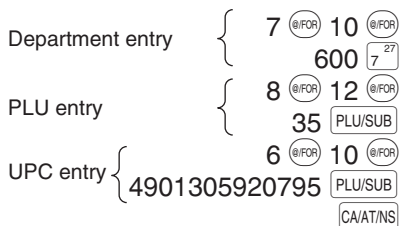

Receipt print

	7 @ 10/	\$6.00
DEPT. 07		T1 \$4.20
	8 @ 12/	\$10.00
PLU0035		T1 \$6.67
	6 @ 10/	\$12.00
NOTEBOOK		T1 \$7.20
MOSE ST		\$18.07
TAX1		\$1.13
ITEMS	3Q	
CASH		\$19.20

■ Single item cash sale (SICS) entry

- This function is useful when a sale is for only one item and is for cash. This function is applicable only to those departments that have been set for SICS or to their associated PLUs, sub-departments or UPCs.
- The transaction is complete and the drawer opens as soon as you press the department key, **DEPT#** key or **PLU/SUB** key.

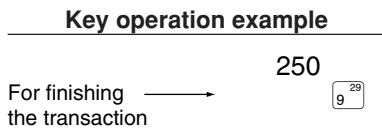

Receipt print

DEPT. 09	T1	\$2.50
MDSE ST		\$2.50
TAX1		\$0.16
ITEMS	1Q	
CASH		\$2.66

Note If an entry to a department, PLU/sub-department or UPC set for SICS follows the ones to departments, PLUs/sub-departments or UPC not set for SICS, it does not finalize and results in a normal sale.

■ PLU/UPC price inquiry (view) function

You can use this function when you want to know the unit price of the PLU/UPC item during transaction in the REG/MGR mode.

To use price inquiry function, follow the procedure below:

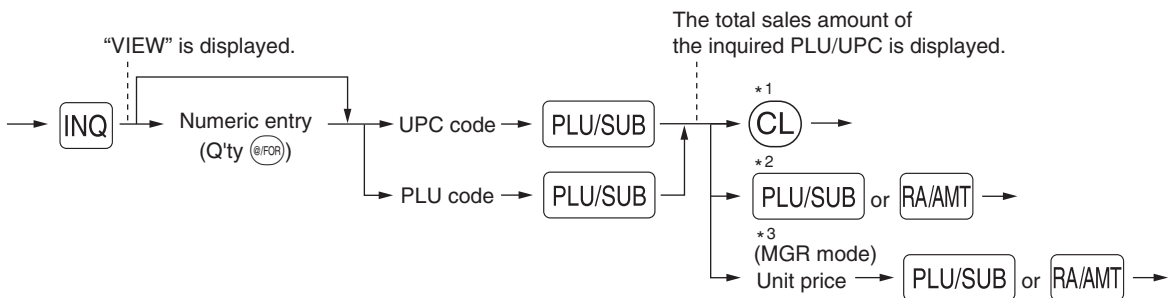

*1: Press the **CL** key to cancel the the inquiring (view) mode.

*2: Press the **PLU/SUB** or **RA/AMT** key when you want to register the unit price of the PLU/UPC displayed.

*3: You can change the unit price temporarily in the MGR mode. The unit price which is programmed in PGM mode is not changed (This is considered a price override entry).

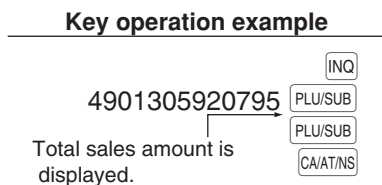

Receipt print

NOTEBOOK	T1	\$12.00
MDSE ST		\$12.00
TAX1		\$0.75
ITEMS	1Q	
CASH		\$12.75

Note For the repeat entry, press the **PLU/SUB** key when having pressed the **PLU/SUB** key, or press the **RA/AMT** key when having pressed the **RA/AMT** key.

■ UPC learning function

When you enter a code which is not preprogrammed, you are required to enter its unit price and the associated department. The UPC code, associated department and unit price entered are stored in the UPC/EAN file and used for future UPC sales entries.

Note

- When there is no capacity remaining in the file, the data is not stored in the file.
- The text of its associated department is applied to the entered UPC code.

To use the UPC learning function, follow the procedure below:

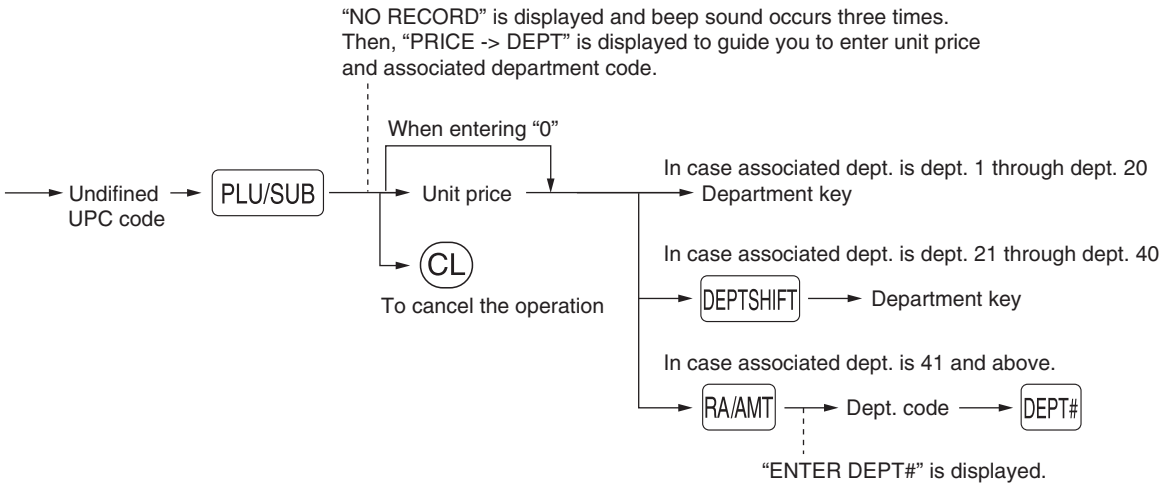

Key operation example

5012345678900 PLU/SUB
 "NO RECORD" ———→ 500
 "PRICE -> DEPT" are displayed.
3²³
CA/AT/NS

Receipt print

DEPT. 03	T1	\$5.00
MOSE ST		\$5.00
TAX1		\$0.31
ITEMS	1Q	
CASH		\$5.31

Note

For the repeat entry, use the PLU/SUB key.

4 Displaying Subtotals

The register provides three types of subtotals:

Merchandise subtotal

Press the **[MDSESBTL]** key at any point during a transaction. The net sale subtotal - not including tax - will appear in the display with the function message "MDSE ST".

Taxable subtotal

Taxable 1 subtotal

Press the **[TAX1SHIFT]** and **[#TM/ SBTL]** keys in this order at any point during a transaction. The sale subtotal of taxable 1 items will appear in the display with the function message "TAX1 ST".

Taxable 2 subtotal

Press the **[TAX2SHIFT]** and **[#TM/ SBTL]** keys in this order at any point during a transaction. The sale subtotal of taxable 2 items will appear in the display with the function message "TAX2 ST".

Including-tax subtotal (complete subtotal)

Press the **[#TM/ SBTL]** key at any point during a transaction. The sale subtotal including tax will appear in the display with the function message "SUBTOTAL".

5 Finalization of Transaction

■ Cash or check tendering

Press the **[#TM/ SBTL]** key to get a complete tax subtotal, enter the amount tendered by your customer, then press the **[CA/AT/NS]** key if it is a cash tender or press the **[CHK]** key if it is a check tender. When the amount tendered is greater than the amount of the sale, the register will show the change due amount with the function message "CHANGE". Otherwise the register will show a deficit with the function message "DUE". You now must make a correct tender entry.

Cash tendering

Key operation example

}
[#TM/ SBTL]
1000 **[CA/AT/NS]**

Receipt print

ITEMS	3Q	
***TOTAL		\$7. 50
CASH		\$10. 00
CHANGE		\$2. 50

Check tendering

Key operation example

}
[#TM/ SBTL]
1000 **[CHK]**

Receipt print

ITEMS	3Q	
***TOTAL		\$7. 50
CHECK		\$10. 00
CHANGE		\$2. 50

■ Cash or check sale that does not require entry

Enter items and press the **CA/AT/NS** key if it is a cash sale or press the **CHK** key if it is a check sale. The register will display the total sale amount.

Key operation example

300 **6**²⁶
 10 **PLU/SUB**
CA/AT/NS

Receipt print

DEPT. 06	T1	\$3.00
PLU0010	T1	\$7.15
MOSE ST		\$10.15
TAX1		\$0.63
ITEMS	2Q	
CASH		\$10.78

In the case of check sale

ITEMS	2Q	
CHECK		\$10.78

■ Charge (credit) sale

Enter items and press a charge key (**CH1** or **CH2**).

Key operation example

2500 **6**²⁶
 3250 **7**²⁷
CH1

Receipt print

DEPT. 06	T1	\$25.00
DEPT. 07	T1	\$32.50
MOSE ST		\$57.50
TAX1		\$3.59
ITEMS	2Q	
CHARGE		\$61.09

■ Mixed-tender sale

You can perform mixed-tendering of check and cash, cash and charge, and check and charge.

Example: The customer pays \$9.50 in cash and \$40.00 by charge 2 for an including-tax subtotal of \$49.50.

Key operation example

}
#/TM/STBL
 950 **CA/AT/NS**
CH2

Receipt print

ITEMS	3Q	
***TOTAL		\$49.50
CASH		\$9.50
CHARGE2		\$40.00

6 Tax Calculation

Automatic tax

When the register is programmed with a tax rate (or tax table) and the tax status of an individual department is set for taxable, it computes the automatic tax on any item that is entered directly into the department or indirectly via a related PLU.

Example: Selling five \$6.70 items (dept. 1, taxable 1) and one \$7.15 item (PLU 85, taxable 2) for cash

Key operation example

5 670

Receipt print

	5 @ \$6.70	
DEPT. 01	T ₁ \$33.50	
PLU0085	T ₂ \$7.15	
MDSE ST	\$40.65	
TAX1	\$2.09	
TAX2	\$0.29	
ITEMS	6Q	
CASH	\$43. 03	

Manual tax

The machine allows you to enter tax manually after it finalizes an item entry.

Example: Selling an \$8.00 item (dept. 12) for cash with 50 cents as tax

Key operation example

800

Receipt print

DEPT. 12	\$8.00	
M-TAX	\$0.50	
ITEMS	1Q	
CASH	\$8. 50	

Tax delete

You can delete the automatic tax on the taxable 1 and taxable 2 subtotal of each transaction by pressing the key after the subtotal is displayed.

To delete taxable 1 subtotal, press , to get taxable 1 subtotal, and then press to delete the subtotal.

To delete taxable 2 subtotal, press , to get taxable 2 subtotal, and then press to delete the subtotal.

To delete all taxable (1-4) subtotals, press , , and ("TAX ST 0.00" is displayed) and press to delete all the taxable subtotals.

Example: Selling a \$7.25 item (dept. 1, taxable 1) and another \$5.15 item (dept. 11, taxable 2) for cash and entering the sale as non-taxable

Key operation example

725

Receipt print

DEPT. 01	T ₁ \$7.25	
DEPT. 11	T ₂ \$5.15	
TAX1 ST	\$0.00	
TAX2 ST	\$0.00	
ITEMS	2Q	
CASH	\$12. 40	

■ Tax status shift

The machine allows you to shift the programmed tax status of each department or the PLU key by pressing the **TAX1SHIFT** and/or **TAX2SHIFT** keys before those keys. After each entry is completed, the programmed tax status of each key is resumed.

Example: Selling the following items for cash with their programmed tax status reversed

- One \$13.45 item of dept. 16 (non-taxable) as a taxable 1 item
- One \$7.00 item of PLU 25 (non-taxable) as a taxable 1 and 2 item
- One \$4.00 item of dept. 11 (taxable 2) as a non-taxable item
- Two \$10.50 items of dept. 1 (taxable 1) as taxable 2 items

Key operation example

1345 **TAX1SHIFT** 16³⁶
 25 **TAX1SHIFT** **TAX2SHIFT** **PLU/SUB**
 400 **TAX2SHIFT** 11³¹
 1050 **TAX1SHIFT** **TAX2SHIFT** 1²¹
 1²¹
CA/AT/NS

Receipt print

DEPT. 16	T ₁	\$13.45
PLU0025	T ₁ T ₂	\$7.00
DEPT. 11		\$4.00
DEPT. 01	T ₂	\$10.50
DEPT. 01	T ₂	\$10.50
MDSE ST		\$45.45
TAX1		\$1.28
TAX2		\$1.12

ITEMS	50
CASH	\$47.85

OPTIONAL FEATURES

1 Auxiliary Entries

■ Discount and premium entries using the percent key

The percent key is used to apply a manually entered or preset discount or premium percent rate to individual items or to a merchandise subtotal. In the default setting, you can manually enter a discount percent rate to both individual items and merchandise subtotal. For manual entry of discount or premium percent rate, enter the rate (up to 100.00) with the numeric keys (you need a decimal point when you enter a fractional percent rate), and press a percent key. When using a preset rate (if programmed), press a percent key. When entry limit is programmed for a percent key, you can not enter a rate over the limit.

Percent calculation for merchandise subtotal

Key operation example

4 **@/FOR**
 140 5²⁵
 570 7²⁷
MDSESBTL
 10 %1
CA/AT/NS

Receipt print

	4 @	\$1.40
DEPT. 05	T ₁	\$5.60
DEPT. 07	T ₁	\$5.70
MDSE ST		\$11.30
		-10%
%1		-1.13
MDSE ST		\$10.17
TAX1		\$0.71

ITEMS	50
CASH	\$10.88

Percent calculation for item entries

Key operation example

800 6²⁶
 7 • 5 %1
 15 PLU/SUB
%2
CA/AT/NS

(When premium and 15% are programmed for the %2 key)

Receipt print

DEPT. 06	T1	\$8.00
		-7.5%
%1		-0.60
PLU0015	T1	\$5.00
		15.00%
%2		\$0.75
MDSE ST		\$13.15
TAX1		\$0.81
ITEMS	20	
CASH		\$13.96

Discount and premium entries using the discount key

The discount key is used to apply a manually entered or preset discount or premium amount to individual items or to a merchandise subtotal. In the default setting, you can manually enter a discount amount to both individual items and merchandise subtotal. For manual entry of discount or premium amounts, enter the amount with the numeric keys, and press the discount key. When using a preset amount (if programmed), press the discount key.

When entry digit limit is programmed for the discount key, you can not enter an amount over the limit.

Discount for merchandise subtotal

Key operation example

575 6²⁶
 10 PLU/SUB
MDSESBTL
 100 ⊖
CA/AT/NS

Receipt print

DEPT. 06	T1	\$5.75
PLU0010	T1	\$7.15
MDSE ST		\$12.90
(-)		-1.00
MDSE ST		\$11.90
TAX1		\$0.81
ITEMS	20	
CASH		\$12.71

Discount for item entries

Key operation example

675 7²⁷
⊖
CA/AT/NS

(When a discount amount of \$0.75 is programmed.)

Receipt print

DEPT. 07	T1	\$6.75
(-)		-0.75
MDSE ST		\$6.00
TAX1		\$0.42
ITEMS	10	
CASH		\$6.42

■ Refund entries

For departments 1 to 20, enter the refund amount and press the **[RFND]** key, and then press the corresponding department key and for departments 21 to 40, enter the refund amount and press the **[RFND]** key, then press the **[DEPTSHIFT]** key and press the corresponding department key (when using the preset price, omit entering the amount). In case of department 41 to 99, enter the department code and press the **[RFND]** key and the **[DEPT#]** key, then enter the refund amount and press the **[DEPT#]** key if necessary.

For a refund of a PLU/UPC item, enter the PLU/UPC code and press the **[RFND]** key, then press the **[PLU/SUB]** key. For a refund of a sub-department item, enter the PLU code and press the **[RFND]** key and **[PLU/SUB]** key, then enter the refund amount and press the **[PLU/SUB]** key.

Key operation example

250 **[RFND]** **[6]**²⁶
 42 **[RFND]** **[DEPT#]** 100 **[DEPT#]**
 7 **[@/FOR]**
 13 **[RFND]** **[PLU/SUB]**
 21 **[RFND]** **[PLU/SUB]** 150 **[PLU/SUB]**
[CA/AT/NS]

Receipt print

DEPT. 06	T1 R-2.50
DEPT. 42	T1 R-1.00
	-7 @ \$2.10
PLU0013	T1 R-14.70
PLU0021	T1 R-1.50
MDSE ST	-19.70
TAX1	-1.23
ITEMS	00
CHANGE	\$20. 93

Note

- The backlight of the display will turn red when the **[RFND]** key is pressed.
- When you disallowed the program setting of "PLU/UPC price look-up at refund entry" (job#16), you have to make the following operation for refund entry of PLU items and UPC items:
 For a refund of a PLU/UPC item, enter the PLU/UPC code and press the **[RFND]** key and **[PLU/SUB]** key, then enter the refund amount and press the **[PLU/SUB]** key.
- For repeat entry of refund, press the same key again as you press the last.

■ Non-add code number entries and printing

You can enter a non-add code number such as a customer's code number and credit card number, a maximum of 16 digits, at any point during the entry of a sale. The cash register will print it at once.

To enter a non-add code number, enter the number and press the **[#/TM/SBTL]** key.

Key operation example

1230 **[#/TM/SBTL]**
 1500 **[6]**²⁶
[CH1]

Receipt print

	#1230
DEPT. 06	T1 \$15.00
MDSE ST	\$15.00
TAX1	\$0.94
ITEMS	10
CHANGE	\$15. 94

2 Auxiliary Payment Treatment

■ Currency conversion

The register allows payment entries in a foreign currency (only cash payment is available). Pressing the **CLK#/CONV** key creates a subtotal in the foreign currency.

When using a programmed currency conversion rate, press the **CLK#/CONV** key after item entries, then enter the tendered amount in foreign currency if not exact amount payment, and press the **CAI/AT/NS** key.

When making a manual entry of a currency conversion rate, after item entries, enter the conversion rate (0.0000 to 9999.9999; you need a decimal point when entering a fractional conversion rate) and press the **CLK#/CONV** key, then enter the tendered amount in foreign currency if not exact amount payment, and press the **CAI/AT/NS** key. In both cases, the change due will be displayed in domestic currency, and when the amount tendered is short, the deficit is shown in domestic currency.

Note

- Press the **CL** key after pressing the **CLK#/CONV** key to cancel payment in a foreign currency.
- If programmed, a foreign currency symbol is printed.

Applying preset conversion rate

Key operation example

	2300	6 ²⁶
	4650	7 ²⁷
Currency conversion →		CLK#/CONV
Amount tendered in foreign currency →	10000	CAI/AT/NS

(When a currency conversion rate 0.8063 is programmed for the **CLK#/CONV** key.)

Receipt print

DEPT. 06	T1	\$23.00	
DEPT. 07	T1	\$46.50	
MDSE ST		\$69.50	
TAX1		\$4.34	
ITEMS	2Q		
***TOTAL		\$73.84	Domestic currency
CONV 1		0.8063	Conversion rate
		€59.54	Foreign currency
CASH		€100.00	Foreign currency
CHANGE		\$50.17	Domestic currency

Foreign currency symbol
(Printed if programmed)

Applying manual conversion rate

Key operation example

	2300	6 ²⁶
	4650	7 ²⁷
Conversion rate →	1 . 275	CLK#/CONV
	10000	CAI/AT/NS

Receipt print

DEPT. 06	T1	\$23.00	
DEPT. 07	T1	\$46.50	
MDSE ST		\$69.50	
TAX1		\$4.34	
ITEMS	2Q		
***TOTAL		\$73.84	Domestic currency
CONV 2		1.275	Conversion rate
		94.15	Foreign currency
CASH		100.00	Foreign currency
CHANGE		\$4.58	Domestic currency

■ Received-on account and paid-out entries

When you receive on account from a customer or when you pay an amount to a vendor, use the **RA/AMT** key or the **RCPT/PO** key respectively.

For the received-on-account (RA) entry, enter the amount, and press the **RA/AMT** key.

For the paid-out (PO) entry, enter the amount and press the **RCPT/PO** key.

Note Cash tendering only available for RA and PO operation.

Key operation example

12345 **#TTM/SBTL**
4800 **RA/AMT**

Receipt print

#12345
***RA \$48.00

■ No sale (exchange)

When you need to open the drawer with no sale, press the **CA/AT/NS** key. The drawer will open and printer will print "NO SALE" on the receipt or journal. If you let the machine print a non-add code number before pressing the **CA/AT/NS** key, a no sale entry is achieved and a non-add code number is printed.

#45678
NO SALE

■ Bottle return

This function is used to handle the deposit and payment (paid out) for returned empty bottles or cans.

This function is applicable only to those departments that have been set for bottle return departments or their associated PLUs, sub-departments or UPCs.

Key operation example

10 **@FOR** 15 **DEPTSHFT** **20**
CA/AT/NS

(When dept. 40 is preprogrammed as a bottle return dept. and also a negative dept.)

Receipt print

DEPT. 40 10 @ -0.15
-1.50
ITEMS 00
CHANGE \$1.50

3 Automatic Sequence Key (**AUTO** key) Entries

You can achieve a programmed transaction by pressing the **AUTO** key.

Key operation example

AUTO

(**AUTO**) = 500 **7** **CA/AT/NS**

Receipt print

DEPT. 07 T1 \$5.00
MDSE ST \$5.00
TAX1 \$0.31
ITEMS 1Q
CASH \$5.31

CORRECTION

1 Correction of the Last Entry (direct void)

If you make an incorrect entry relating to a department, PLU/sub-department, UPC, percentage (%1 and %2), discount (⊖) or refund, you can void this entry by pressing the **VOID** key immediately after the incorrect entry.

Key operation example

```

1250 [6] [26]
      [VOID]
2 [PLU/SUB]
   [VOID]
4901305920795 [PLU/SUB]
                [VOID]
600 [8] [28]
     [%2]
     [VOID]
328 [9] [29]
    [⊖]
    [VOID]
250 [RFND] [6] [26]
     [VOID]
     [CA/AT/NS]
  
```

Receipt print

```

DEPT. 06      T1 $12.50
DEPT. 06      T1 V-12.50
PLU0002       $1.50
PLU0002       V-1.50
NOTEBOOK     T1 $12.00
NOTEBOOK     T1 V-12.00
DEPT. 08      T1 $6.00
              15.00%
%2            $0.90
%2            V-0.90
DEPT. 09      T1 $3.28
(-)           -0.28
(-)           V$0.28
DEPT. 06      T1 R-2.50
DEPT. 06      T1 RV$2.50
MDSE ST      $9.28
TAX1         $0.58

ITEMS        2Q
CASH      $9.86
  
```

Note The backlight of the display will turn red when the **VOID** key is pressed.

2 Correction of the Next-to-last or Earlier Entry (indirect void)

You can void any incorrect department entry, PLU/sub-department entry, UPC entry or item refund entry made during a transaction if you find it before finalizing the transaction (e.g. pressing the **CA/AT/NS** key). This function is applicable to department, PLU/sub-department, UPC and refund entries only.

Press the **VOID** key just before you press a department key, **DEPT#** key (before the first depression of the **DEPT#** key in case open and preset entries are allowed) or **PLU/SUB** key. For the refund indirect void, press the **VOID** key after you press the **RFND** key.

Key operation example

```

Correction of a department entry → 1310 [6] [26]
                                   1755 [7] [27]
                                   10 [PLU/SUB]
                                   12 [PLU/SUB]
                                   4901305920795 [PLU/SUB]
                                   250 [RFND] [6] [26]
Correction of a PLU entry →       825 [7] [27]
                                   1310 [VOID] [6] [26]
                                   12 [VOID] [PLU/SUB]
Correction of a UPC entry →       4901305920795 [VOID] [PLU/SUB]
                                   250 [RFND] [VOID] [6] [26]
Correction of a refund entry →     [CA/AT/NS]
  
```

Receipt print

```

DEPT. 06      T1 $13.10
DEPT. 07      T1 $17.55
PLU0010       T1 $7.15
PLU0012       T1 $3.60
NOTEBOOK     T1 $12.00
DEPT. 06      T1 R-2.50
DEPT. 07      T1 $8.25
DEPT. 06      T1 V-13.10
PLU0012       T1 V-3.60
NOTEBOOK     T1 V-12.00
DEPT. 06      T1 RV$2.50
MDSE ST      $32.95
TAX1         $2.06

ITEMS        3Q
CASH      $35.01
  
```

3 Subtotal Void

You can void an entire transaction. Once subtotal void is executed, the transaction is aborted and the register issues a receipt. This function does not work when more than 50 items have been entered.

Key operation example

1310 ²²
 ²²
1755 ²⁶
10
35
Subtotal void {

Receipt print

DEPT. 02	T: \$13.10
DEPT. 02	T: \$13.10
DEPT. 06	T: \$17.55
PLU0010	T: \$7.15
PLU0035	T: \$10.00
MDSE ST	\$60.90
SBTL VD	-60.90
***TOTAL	\$0.00

Note

The backlight of the display will turn red when the key is pressed.

4 Correction of Incorrect Entries not Handled by the Direct or Indirect Void Function

Any errors found after the entry of a transaction has been completed or during an amount tendered entry cannot be voided. These errors must be corrected by the manager.

The following steps should be taken:

1. If making the amount tendered entry, finalize the transaction.
2. Make correct entries from the beginning.
3. Hand the incorrect receipt to the manager for its cancellation.

PRIOR TO PROGRAMMING

Before starting sales entries, you must first program necessary items so the cash register suits your sales needs. In this manual, there are three sections, **BASIC FUNCTION PROGRAMMING where required items must be programmed**, **AUXILIARY FUNCTION PROGRAMMING** where you can program for more convenient use of keys on the keyboard, and **ADVANCED PROGRAMMING** where various optional programming features are provided. Find the appropriate features for your needs, and make the necessary programming changes.

Note You can select the text language (English or Spanish) printed on receipts and journals. For the language selection, please refer to "Language Selection" described later in this section.

■ Procedure for programming

1. Check to see whether both journal and receipt rolls are present in the machine. If there is not enough paper on a roll, replace it with a new one (refer to MAINTENANCE section for the replacement).
2. Put the manager key in the mode switch and turn it to the PGM position.
3. Program necessary items into the cash register.
Every time you program an item, the cash register will print the setting. Please refer to print samples in each section.
4. If necessary, issue programming reports for your reference.

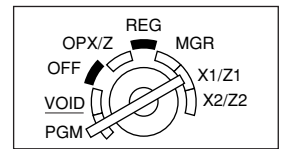

Note

- On the key operation example shown in the programming details, numbers such as "01262010" indicates the parameter which must be entered using the corresponding numeric keys.
- Asterisks in the tables shown in the programming details indicate default settings.

BASIC FUNCTION PROGRAMMING

(For Quick Start)

1 Date and Time Programming

■ Date

For setting the date, enter the date in 8 digits using the month-day-year (MM/DD/YYYY) format, then press the **#/TM/SBTL** key.

Procedure

Date(MM/DD/YYYY) → **#/TM/SBTL**

Key operation example

01262010 **#/TM/SBTL**
(Jan. 26, 2010)

Print

PGM 01/26/2010 — Date

Note You can use the date format of day-month-year (DD/MM/YYYY) or year-month-day (YYYY/MM/DD) format. To change the format, refer to "Various Function Selection Programming 1" section (Job code 61).

■ Time

For setting the time, enter the time in 4 digits (“hhmm” format) using the 24-hour format. For example, when the time is set to 2:30 AM, enter 230; and when it is set to 2:30 PM, enter 1430.

Procedure

Time(max. 4 digits in 24-hour format) → #/TM/SBTL

Key operation example

1430 #/TM/SBTL

Print

PGM 2:30PM Time

Note

For display and print, 12-hour format is applied by default. To change it to 24-hour format, refer to “Various Function Selection Programming 1” section (Job code 61).

2 Tax Programming for Automatic Tax Calculation Function

Before you can proceed with ringing sales transactions, you must first program the tax that is levied in accordance with the laws of your state. The cash register comes with the ability to program four different tax rates. In most states, you will only need to program Tax 1. However if you live in an area that has a separate local tax (such as a Parish tax) or a hospitality tax, the register can be programmed to calculate these separate taxes.

When you program the tax status for a department, tax will automatically be added to sales of items assigned to the department according to the programmed tax status for the department. You can also enter tax manually.

There are two tax programming methods. The tax rate method uses a straight percentage rate per dollar. The tax table method requires tax break information from your state or local tax offices. Use the method which is acceptable in your state. You can obtain necessary data for tax programming from your local tax office.

■ Tax programming using a tax rate

The percent rate specified here is used for tax calculation on taxable subtotals.

Procedure

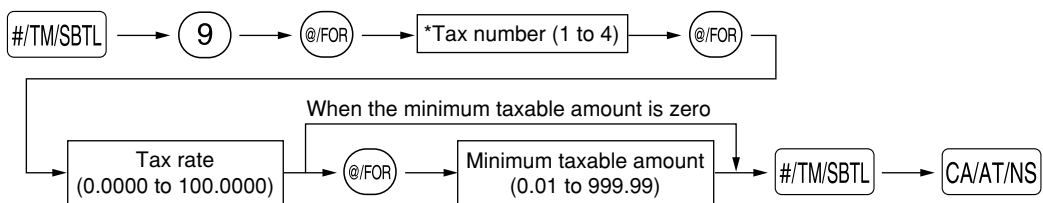

To delete a tax rate, use the following sequence:

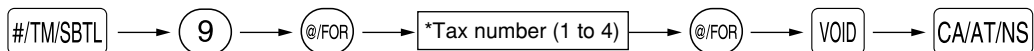

Example: Programming the tax rate 4% as tax rate 2 with tax exempt as 12¢

Key operation example



Print

PGM	
T2	4.0000%
	0.12

- Note**
- If you make an incorrect entry before pressing the third **@/F/O/R** key in programming a tax rate, cancel it with the **CL** key.
 - You do not need to enter the trailing zeros of a tax rate (after the decimal point), but you do need to enter the decimal for fractions.

■ The tax table (applicable to the add-on tax)

If you are in an area that uses a tax table for tax calculation, you can program the cash register accordingly. Tax table programming can be performed for Tax 1 through Tax 4.

Sample tax table

New Jersey tax table: 6%

To program a tax table, first make a table like the right table shown above.

Taxes	Range of sales amount	
	Minimum breakpoint	Maximum breakpoint
.00	.01	to .10
.01 — T	.11 — Q	to .22
.02	.23	to .38
.03	.39	to .56
.04	.57	to .72
.05	.73	to .88
.06	.89	to 1.10
.07	1.11 — M1	to 1.22
.08	1.23	to 1.38
.09	1.39	to 1.56
.10	1.57	to 1.72
.11	1.73	to 1.88
.12	1.89	to 2.10
.13	2.11 — M2	to 2.22



A: Difference between the minimum breakpoint and the next one (¢)	
—	
10 (0.11 - 0.01)	B: Non-cyclic
12 (0.23 - 0.11)	C: Cyclic-1
16 (0.39 - 0.23)	
18 (0.57 - 0.39)	
16 (0.73 - 0.57)	
16 (0.89 - 0.73)	D: Cyclic-2
22 (1.11 - 0.89)	
12 (1.23 - 1.11)	
16 (1.39 - 1.23)	
18 (1.57 - 1.39)	
16 (1.73 - 1.57)	
16 (1.89 - 1.73)	
22 (2.11 - 1.89)	

From the tax table, calculate the differences between a minimum breakpoint and the next one (A). Then, from the differences, find irregular cycles (B) and regular cycles (C and D). These cycles will show you the following items necessary to program the tax table:

- T:** The tax amount collected on the minimum taxable amount (Q)
- Q:** The minimum taxable amount
- M1:** The maximum value of the minimum breakpoint on a regular cycle (C)
We call this point "MAX point."
- M2:** The maximum value of the minimum breakpoint on a regular cycle (D)
We call this point "MAX point."
- M:** Range of the minimum breakpoint on a regular cycle: difference between Q and M1 or between M1 and M2

Procedure

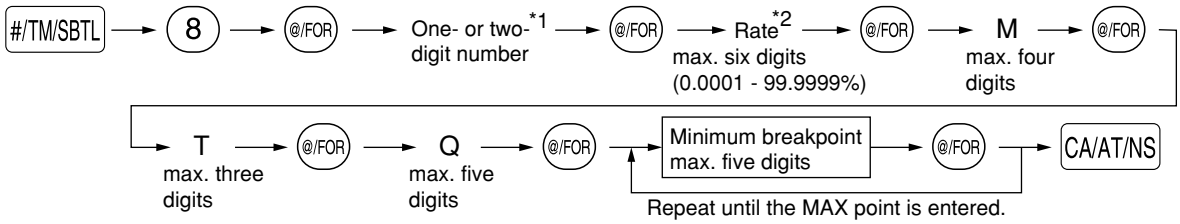

To delete a tax table, use the following sequence:

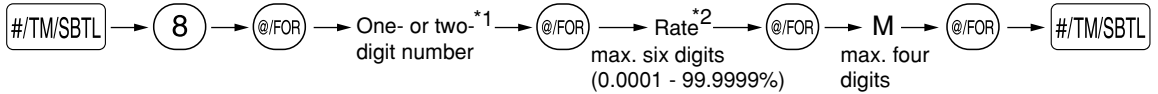

***1 First figure: (1 or 0)** The first figure to be entered depends upon whether the difference between a minimum breakpoint to be entered and the preceding minimum breakpoint is not less than \$1.00 or more than 99¢. When the difference is not less than \$1.00, enter “1,” and when it is not more than 99¢, enter “0” or nothing.

Second figure: (1 to 4) The second figure depends upon whether your tax table is to be programmed as tax table 1, 2, 3 or 4.

***2** If the rate is fractional (e.g. 4-3/8%), then the fractional portion (3/8) would be converted to its decimal equivalent (i.e. .375) and the resulting rate of 4.375 would be entered. Note that the nominal rate (R) is generally indicated on the tax table.

Note If you make an incorrect entry before entering the M in programming a tax table, cancel it with the **CL** key; and if you make an error after entering the M, cancel it with the **#/TM/SBTL** key. Then program again from the beginning.

• Limitations to the entry of minimum breakpoints

The register can support a tax table consisting of no more than 72 breakpoints. (The maximum number of breakpoints is 36 when the breakpoint difference is \$1.00 or more.) If the number of breakpoints exceeds the register’s table capacity, then the manual entry approach should be used.

Example: Programming the sample tax table shown on the previous page as tax table 1

Key operation example		Print
	#/TM/SBTL 8 @/FOR	*PGM*
	1 @/FOR	T1 6.0000%
Tax rate	→ 6 @/FOR	/ 1.00
M	→ 100 @/FOR	1 0.11
T	→ 1 @/FOR	2 0.23
Q	→ 11 @/FOR	3 0.39
The first cyclic portion	23 @/FOR	4 0.57
	39 @/FOR	5 0.73
	57 @/FOR	6 0.89
	73 @/FOR	7 1.11
M1 (MAX point)	→ 89 @/FOR	
	111 @/FOR	
	CA/AT/NS	

Note You do not need to enter the trailing zeros of a tax rate (after the decimal point) but you do need to enter the decimal point for fractions.

- If the tax is not provided for every cent, modify the tax table by setting the tax for every cent in the following manner.

When setting the tax, consider the minimum breakpoint corresponding to unprovided tax to be the same as the one corresponding to the tax provided on a large amount.

Sample tax table
Example 8%

Tax	Minimum breakpoint
.00	.01
.01	.11
.02	.26
.03	.47
.04	.68
.06	.89
.09	1.11
.10	1.26
.11	1.47
.12	1.68
.14	1.89
.17	2.11

Modification of the left tax table

Tax	Minimum breakpoint
.00	.01
.01 → T	.11 → Q
.02	.26
.03	.47
.04	.68
.05	.89
.06	.89
.07	1.11 → M1
.08	1.11
.09	1.11
.10	1.26
.11	1.47
.12	1.68
.13	1.89
.14	1.89
.15	2.11 → M2
.16	2.11
.17	2.11



Breakpoint difference (¢)	
1	
10 (0.11-0.01)	B: Non-cyclic
15 (0.26-0.11)	
21 (0.47-0.26)	
21 (0.68-0.47)	
21 (0.89-0.68)	
0 (0.89-0.89)	
22 (1.11-0.89)	C: Cyclic-1
0 (1.11-1.11)	
0 (1.11-1.11)	
15 (1.26-1.11)	
21 (1.47-1.26)	
21 (1.68-1.47)	
21 (1.89-1.68)	
0 (1.89-1.89)	
22 (2.11-1.89)	D: Cyclic-2
0 (2.11-2.11)	
0 (2.11-2.11)	

From the modified tax table above;

Rate = 8(%), T = \$0.01 = 1¢, Q = \$0.11 = 11¢, M1 = 1.11, M2 = 2.11, M = 100

AUXILIARY FUNCTION PROGRAMMING

1 Department Programming

Merchandise can be classified into a maximum of 99 departments. Items sold using the department keys can later be printed on a report shown as the quantities sold and sales amounts classified by department. The data is useful for making purchasing decisions and other store operations. Departments can be assigned to articles whose prices were set using PLU/UPC function.

When using a department key, you must set the parameters to specify the department status, such as positive or negative department. Prices can be assigned directly to department keys for frequently purchased items, which enables you to enter the prices by simply pressing the department keys.

Department status

Procedure

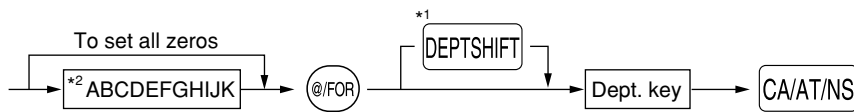

*1: To program departments 21 through 40, press the department shift key.

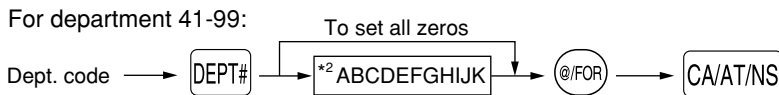

To program another department, start from the beginning without pressing the CA/AT/NS key.

*2:Item:	Selection:	Entry:
A Type	Bottle return	1
	Normal*	0
B Group number		0-9 (0:Non group)(default:0)
C Commission group number		0-2 (0:Non commission)(default:0)
D Tax 4 status	Taxable	1
	Non-taxable*	0
E Tax 3 status	Taxable	1
	Non-taxable*	0
F Tax 2 status	Taxable	1
	Non-taxable*	0
G Tax 1 status	Taxable(* for dept. 1 thru dept. 10)	1
	Non-taxable(* for dept. 11 thru dept.99)	0
H SICS / Normal	SICS	1
	Normal*	0
I Sign	Negative department	1
	Positive department*	0
J Entry digit limit		0-7 (default:7)
K Type of unit price entry	Open and preset	3
	Preset only	2
	Open only*	1
	Inhibit department key	0

Type

- Select whether you use a department as normal department or for bottle return.

Group number

- If group setting (0 to 9, 0: non group) is done, items sold using the department keys and the associated PLUs and UPCs can be classified into groups for reporting the sales.

Commission group number

- A commission group (0 to 2, 0: non commission) can be assigned to each department for commission for clerks. Each commission amount for each clerk is calculated based on a programmed commission rate and later printed on clerk reports.

Tax status (taxable 1 through 4 / non-taxable)

- When any entry of a taxable department is made in a transaction, tax is automatically computed according to the associated tax table or rate.

SICS (Single Item Cash Sale)

- If an entry of a department programmed for SICS is made first, the sale will be finalized as a cash sale as soon as the department key is pressed. If the entry is made after entering a department not programmed for SICS, the sale will not be finalized until the CA/AT/NS key is pressed.

Entry digit limit

- Set the number of allowable digits for the maximum entry amount for each department. The limit is effective for operations in the REG mode and can be overridden in the MGR mode.

Example: Programming department 2 as normal dept. group 1, commission group 1, taxable 1, SICS, negative department, entry digit limit - 7 digits, and allowing open & preset entry.
(ABCDEFGHIJK: 01100011173)

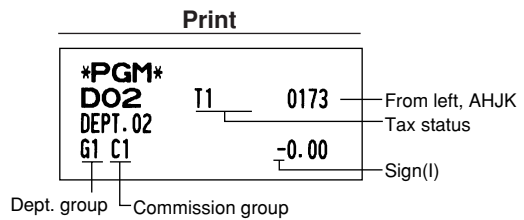
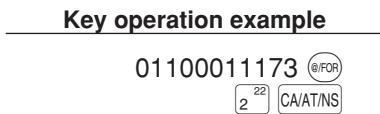

■ Preset unit price

Procedure

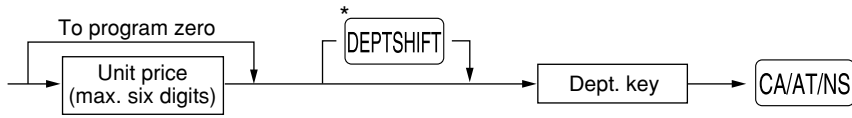

*To program departments 21 through 40, press the department shift key.

For department 41-99:

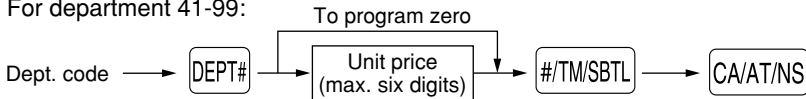

To program another department, start from the beginning without pressing the CA/AT/NS key.

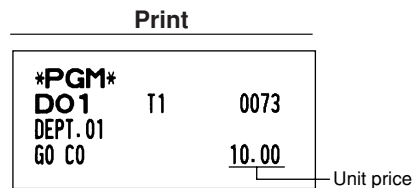
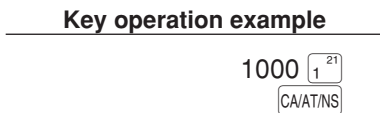

Note

If a department is not programmed to allow the entry of preset unit prices in functional programming, the department is automatically changed to allow the entry of preset unit prices by this programming entry.

2 PLU/UPC Programming

The cash register can handle PLU codes and UPC codes.

PLU (Price Look-Up) codes are used for PLU and sub-department functions:

The PLU function allows speedy key entries whereby a price is automatically called up when a code is entered. The sub-department is a kind of "open PLU", which requires you to enter a price after the PLU code is entered. PLU codes consist of 4-digit numbers and leading zeros can be applied to the PLU codes.

The cash register allows you to keyboard UPC-A (number system character: 0,2,3,4,5), UPC-E, EAN-8 and EAN-13 barcodes. The register also allows you to keyboard add-on codes (2 digits or 5 digits) added to EAN-13 codes except ISBN and ISSN codes.

Unit prices for UPC codes must be preset. This means that even if price information is contained in a code, the register does not refer to it for sales registration.

A maximum of 7000 PLU or UPC codes settings are possible. Each one belongs to a department and acquires the department's parameters (dept. type (normal or bottle return), dept. group, tax status, SICS and sign). A commission group (0 to 2, 0: No commission is applied) can be assigned to each department for commission for clerks. Each commission amount for individual clerk is calculated based on the corresponding programmed commission rate and printed later on clerk reports.

The cash register is preprogrammed so PLU1 through PLU1200 as PLUs (commission group: 0) associated with department 1 and preset unit price "0".

Unit price and associated department assignment

Procedure

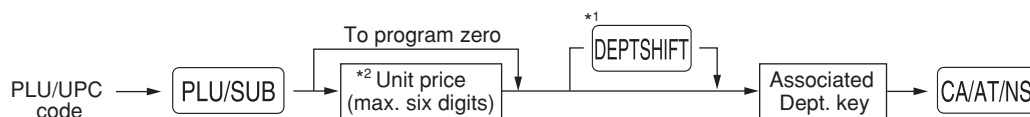

*1: To assign departments 21 through 40, press the department shift key.

When the associated department is department 41-99:

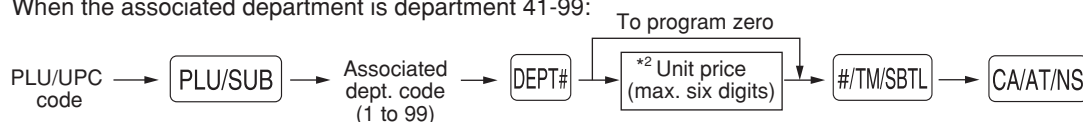

*2: For a sub-department, set the limit amount of unit price entry.

To program the following PLU/UPC, start from entering a unit price or an associated department code without pressing the **CA/AT/NS** key.

To program another PLU/UPC, start from the beginning without pressing the **CA/AT/NS** key.

Key operation example

```

1 [PLU/SUB]
125 [3] 23
323456789108 [PLU/SUB]
360 [1] 21
[CA/AT/NS]
    
```

Print

```

*PGM*
P0001 (O3)
PLU0001 1.25
323456789108# (O1)
3.60
CO 1
    
```

Associated dept. (O3)
Unit price (O1)
PLU code (323456789108)
UPC code (323456789108#)

To delete a PLU/UPC code, use the following sequence:

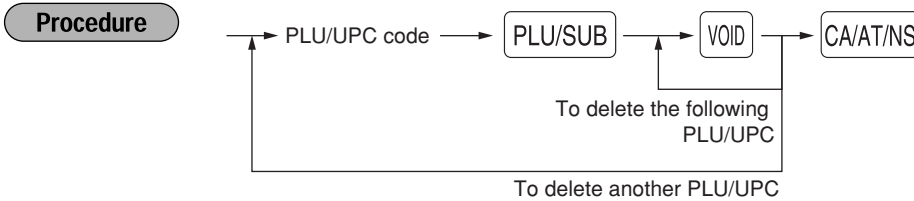

Function selection

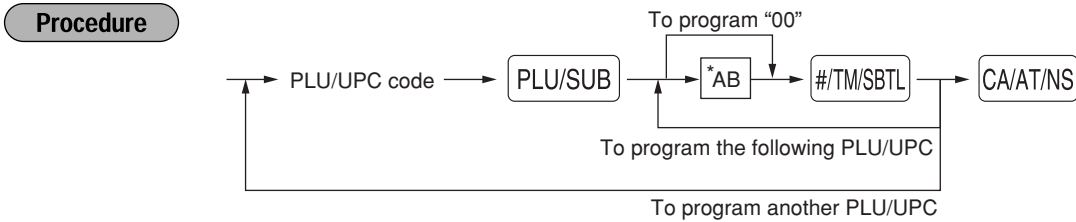

*: Item:	Selection:	Entry:
A Commission group number		0-2 (0: Non commission)(default:0)
B PLU/sub-department selection (For PLU code only)	Sub-department PLU*	0 1

When programming UPC codes, always enter 1 for B.

Key operation example

1 PLU/SUB
10 #/TM/SBTL CA/AT/NS

Print

```
*PGM*
P0001      (03)
PLU0001    1.25
           C1 0
```

PLU/sub-dept. selection
Commission group number

Note When you program all 7000 PLU/UPC codes, the programming sequence will be complete with a press of the #/TM/SBTL key.

3 Commission Rate Programming

Based on each clerk's sales total of each commission group and the corresponding commission rate, the commission amounts are calculated, which is printed on clerk reports.

Commission rate

Procedure

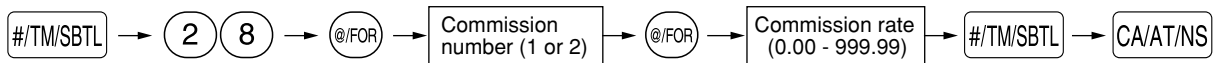

Key operation example

#/TM/SBTL 28 @/FOR
1 @/FOR
15 #/TM/SBTL CA/AT/NS

Print

```
*PGM*
F52 COM. SAL1    15.00%
```

Note You must use a decimal point when setting a fractional rate.

4 Miscellaneous Key Programming

The cash register provides miscellaneous keys such as $\%1$, $\%2$, \ominus , RFND , RA/AMT (when using as RA key), RCPTPO (when using as PO key), CLK\#/CONV (when using as CONV key), TAX , CHK , CH1 , CH2 and CA/AT/NS (when using as CA key). While the cash register is pre-programmed so you can use these keys, you must set a currency conversion rate to use CLK\#/CONV key. You can also program these keys for more convenient use. Please refer to the data below for programming these keys. Factory setting is indicated with parentheses.

$\%1$, $\%2$	Percent rate (0.00%), tax status (non-taxable), sign (minus), item % and subtotal % entry* (both are allowed), percent rate limitation (100%)
\ominus	Amount (0.00), tax status (non-taxable), sign (minus), item \ominus and subtotal \ominus entry* (both are allowed), entry digit limit (7 digits)
RFND	Not necessary to program
RA/AMT , RCPTPO	Entry digit limit (9 digits)
CLK\#/CONV	Currency conversion rate (0.0000), currency conversion rate entry method - open or preset (both are enabled)
CHK , CH1 , CH2 and CA/AT/NS	Compulsory entry of amount tender (not compulsory), entry digit limit (8 digits), footer printing (not printed)
TAX (Manual tax)	Entry digit limit (7 digits)

* Item %/Item \ominus : Percent/discount calculation is applied to individual department and PLU/UPC.

* Subtotal %/Subtotal \ominus : Percent/discount calculation is applied to subtotals.

■ Rate for $\%1$, $\%2$ and CLK\#/CONV (when using as CONV key)

Procedure

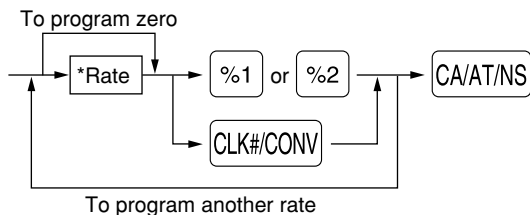

*: Rate

0.00 — 100.00 (% rate)

0.0000 — 9999.9999 (Currency conversion rate)

Key operation example

```

    10 • 25 %1
    0 • 8063 CLK#/CONV
           CA/AT/NS
  
```

Print

PGM		
F02 %1	000	Percent rate
L100.00%	-10.25%	
F47 CONV 1	00	Currency conversion rate
	0.8063	

Note You must use a decimal point when setting fractional rates.

■ Amount for ⊖

Procedure

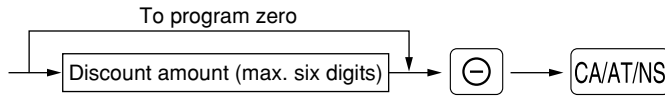

Key operation example

200 ⊖
CA/AT/NS

Print

```
*PGM*
F01 (-)          007
                  -2.00
                  |
                  |----- Discount amount
```

■ Percent rate limitation for %1 and %2

Procedure

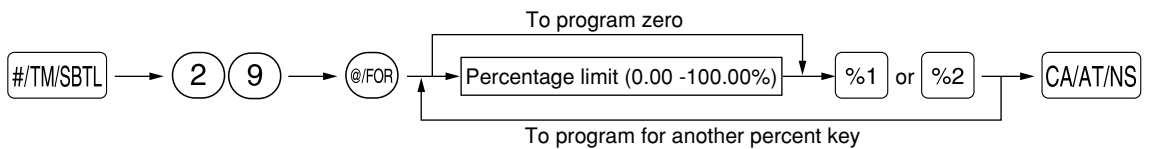

Note

- Percent entries that exceed the upper limit may be overridden in the MGR mode.
- 10.00% can be entered as 1 0 or 1 0 • 0 0. The • key is needed only for fractional entry.

Key operation example

#/TM/SBTL 29 @/FOR
15 • 00 %1
CA/AT/NS

Print

```
*PGM*
F02 %1          000
L 15.00%       -10.25%
                |
                |----- Percentage limit
```

■ Function parameters for %1, %2 and ⊖

Procedure

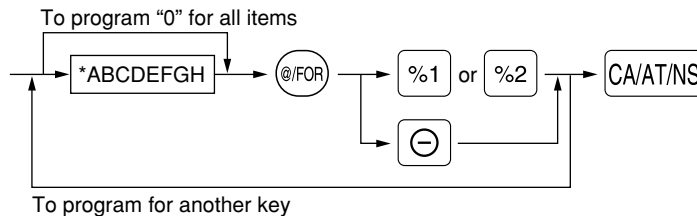

*: Item:	Selection:	Entry:
A Tax 4 status	Taxable	1
	Non-taxable*	0
B Tax 3 status	Taxable	1
	Non-taxable*	0
C Tax 2 status	Taxable	1
	Non-taxable*	0
D Tax 1 status	Taxable	1
	Non-taxable*	0
E +/- sign	+ (premium) sign	0
	- (discount) sign*	1
F Item % / Item ⊖	Allow*	0
	Disallow	1
G Subtotal % / Subtotal ⊖	Allow*	0
	Disallow	1
H Entry digit limit for discount key		0-7 (default:7)

When programming percent keys, always enter 0 for H.

Tax status (taxable 1 through 4 / non-taxable)

- When taxable is selected, tax is applied to the amount obtained after premium or discount calculation.

+/- sign

- Programming of the +/- sign assigns the premium or discount function for each key.

Entry digit limit (For discount key only)

- The entry digit limit is in effect for the REG mode operations but can be overridden in the MGR mode. The entry digit limit is represented by the number of allowable digits for the maximum entry amount for discount key. If "0" is set, open price entry is prohibited.

Example: Programming the discount key as taxable 1, discount (minus sign), allowing both the item and subtotal (-), and entry digit limit - 6 digits. (ABCDEFGH: 00011006)

Key operation example

00011006 ⊖ ⊕ CA/AT/NS

Print

```
*PGM*
F01 (-)      006
             -2.00
             |
             T1
             |
             Tax status
```

From left, FGH
Sign(E)

Function parameters for CLK#/CONV

Procedure

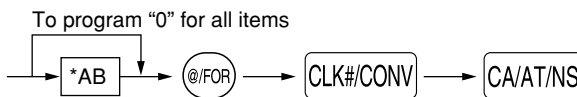

*: Item:	Selection:	Entry:
A Open rate entry	Allow*	0
	Disallow	1
B Preset rate entry	Allow*	0
	Disallow	1

Key operation example

00 ⊕ CLK#/CONV CA/AT/NS

Print

```
*PGM*
F47 CONV 1      00
                 0.8063
```

From left, AB

■ Entry digit limit for **RA/AMT** (when using as RA key), **RCPT/PO** (when using as PO key) and **TAX**

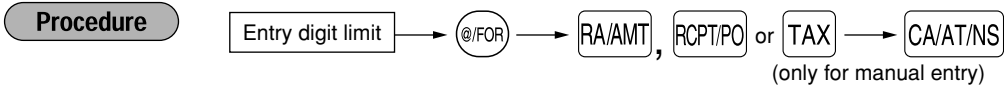

- For **RA/AMT** **RCPT/PO**, enter 0 to 9 (digits), and for **TAX** (manual tax), enter 0 to 7 (digits).
Entry digit limit is in effect for REG mode operation but can be overridden in MGR mode. The entry digit limit is represented by the number of allowable digits for maximum entry or total amount. When “0” is set, the operation of the corresponding key is prohibited.

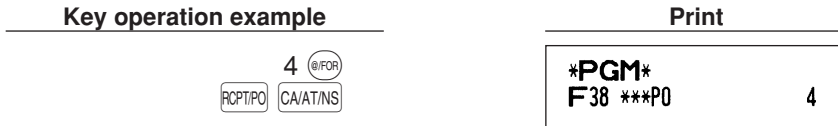

■ Function parameters for **CHK**, **CH1**, **CH2** and **CA/AT/NS** (when using as CA key)

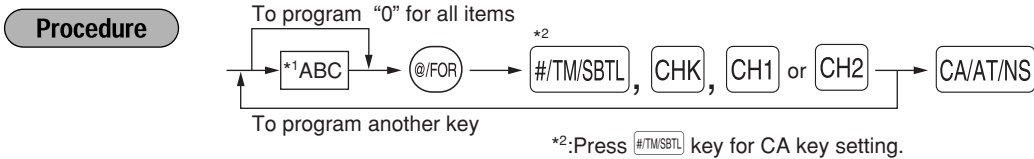

*1:Item:	Selection:	Entry:
A Footer printing	Allow	1
	Disallow*	0
B Amount tendered entry	Compulsory	1
	Non-compulsory (for the CA or CHK keys)*	0
	Inhibit (for the CH1 or CH2 key)*	0
C Entry digit limit		0-8 (default:8)

Footer printing

- This option decides whether or not the machine should print a message at the bottom of receipt when a specified media key is used. To program a footer logo message, refer to “Logo messages” section on page 50.

Amount tendered compulsory

- You may select amount tendered, compulsory or optional, for the **CA/AT/NS** and **CHK** keys.
- You may select amount tendered, compulsory or inhibited, for the **CH1** and **CH2** key.

Entry digit limit

- For the **CH1**, **CH2** and **CHK** keys, program upper limit entry amount for the tendered amount. For the **CA/AT/NS** key, program upper limit entry for total cash amount which can be handled on the register. The entry digit limit is in effect for REG mode operation but can be overridden in the MGR mode. The entry digit limit is represented by the number of allowable digits for the maximum entry or total amount. When “0” is set, the operation of the corresponding key is prohibited.



5 Text Programming

The register allows you to program text for clerk names, department item names, PLU/UPCs item names, if necessary. There are two ways for programming text: using character keys on the keyboard or entering character codes with numeric keys on the keyboard.

Using character keys on the keyboard

You can enter characters according to the small figures printed in the lower right position of the tops. For the layout, please refer to “Keyboard” section on page 6.

The following are used as control keys for character entry:

- SHIFT** Toggles between upper-case and lower-case letters. By default, the upper-case letter is selected. Once the **SHIFT** key is pressed, you are locked in for entering lower-case letters. “a” is displayed when lower-case letters entry is selected as shown in the operator display example below.
- NUMBER** Press the **NUMBER** key to enter numeric characters. For example to enter “1”, press the **NUMBER** and **1** key. If you press the **1** key without pressing the **NUMBER** key, the cash register goes to character codes entry mode. Once the **NUMBER** key is pressed, you are locked in for entering numeric characters. “1” is displayed when numeric characters entry is selected as shown in the operator display example below.
- DC** Toggles between single-size and double-size characters. By default, the single-size character is selected. Once the **DC** key is pressed, you are locked in for entering double size characters. “W” is displayed when double-size characters entry is selected as shown in the operator display example below.
- BS** Backs up the cursor, erasing the character to the left.

Operator display (Example)

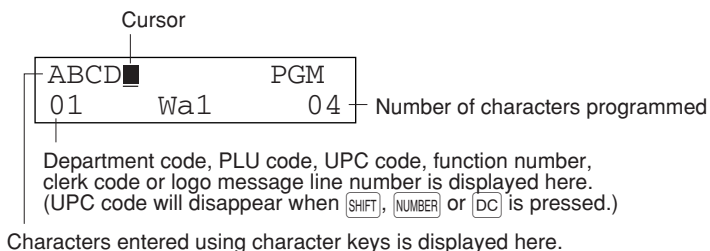

Example To program the word “Clerk01” with the letter “C” being double size

To make the letter “C” double size character	DC C	<table style="width: 100%; border-collapse: collapse;"> <tr> <td style="width: 30%;">=C</td> <td style="width: 40%; text-align: center;">PGM</td> </tr> <tr> <td>01</td> <td style="text-align: center;">W 02</td> </tr> </table>	=C	PGM	01	W 02
=C	PGM					
01	W 02					
To return character to normal size	DC	<table style="width: 100%; border-collapse: collapse;"> <tr> <td style="width: 30%;">=C</td> <td style="width: 40%; text-align: center;">PGM</td> </tr> <tr> <td>01</td> <td style="text-align: center;">02</td> </tr> </table>	=C	PGM	01	02
=C	PGM					
01	02					
To toggle the characters to lower-case letters	SHIFT	<table style="width: 100%; border-collapse: collapse;"> <tr> <td style="width: 30%;">=C</td> <td style="width: 40%; text-align: center;">PGM</td> </tr> <tr> <td>01</td> <td style="text-align: center;">a 02</td> </tr> </table>	=C	PGM	01	a 02
=C	PGM					
01	a 02					
	L E R K	<table style="width: 100%; border-collapse: collapse;"> <tr> <td style="width: 30%;">=Clerk</td> <td style="width: 40%; text-align: center;">PGM</td> </tr> <tr> <td>01</td> <td style="text-align: center;">a 06</td> </tr> </table>	=Clerk	PGM	01	a 06
=Clerk	PGM					
01	a 06					
To enter numbers	NUMBER 0 1	<table style="width: 100%; border-collapse: collapse;"> <tr> <td style="width: 30%;">=Clerk01</td> <td style="width: 40%; text-align: center;">PGM</td> </tr> <tr> <td>01</td> <td style="text-align: center;">a1 08</td> </tr> </table>	=Clerk01	PGM	01	a1 08
=Clerk01	PGM					
01	a1 08					

Entering character codes with numeric keys on the keyboard

Numerals, letters and symbols are programmable by entering the character code and the **00** key. (If numeric characters entry is selected, "1" is displayed on the operator display (lower line). Press the **NUMBER** key to release it.) Set the alphanumeric character code table on the next page. By doing this, you can program characters other than those on the key tops.

- Double-size characters can be made by entering the character code 253 or pressing the **DC** key. "W" is displayed when double-size characters entry is selected as shown in the operator display example below.
- All three digits of the character code **MUST** be entered (even if it starts with zero).

Operator display (Example)

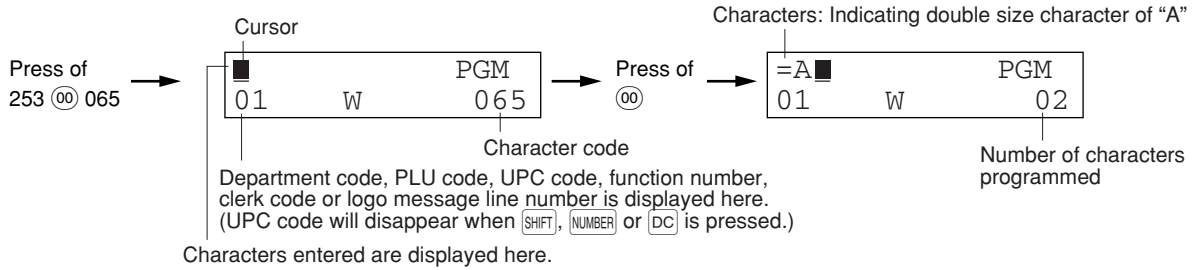

Example

To program the word "SHARP" in double-size characters

253 **00** 083 **00** 072 **00** 065 **00** 082 **00** 080 **00**

S
H
A
R
P

When you press an appropriate number key (job code number) and press the **00** key for text entry just after you start programming with the **#TMSBTL** key, the cash register will automatically be ready for text entry.

Alphanumeric character code table

Code	Character	Code	Character	Code	Character	Code	Character	Code	Character
001	á	046	.	091	Ä	136	→	193	ı
002	â	047	/	092	Ö	137	ƒ	194	Ġ
003	ê	048	0	093	Ü	138	Œ	195	Ş
004	î	049	1	094	^	139	◀	196	Ğ
005	ì	050	2	095	_	140	▶	197	ġ
006	í	051	3	096	‘	141	F	198	Ƙ
007	ô	052	4	097	a	142	T	199	ƙ
008	ó	053	5	098	b	143	↓	200	ƚ
009	û	054	6	099	c	144	ç	201	ƚ
010	ú	055	7	100	d	145	°	202	ž
011	œ	056	8	101	e	146	ı	203	Đ
012	ú	057	9	102	f	147	ù	204	đ
013	ú	058	:	103	g	148	à	205	Ĉ
014	š	059	;	104	h	149	Æ	206	ć
015	ó	060	<	105	i	150	ø	207	€
016	Λ	061	=	106	j	151	Å	208	Ɔ
017	Ψ	062	>	107	k	152	□	209	˘
018	Γ	063	?	108	l	153	é	210	ë
019	˘	064	@	109	m	154	è	211	š
020	Ω	065	A	110	n	155	Pt	212	č
021	Δ	066	B	111	o	156	i	213	ž
022	Θ	067	C	112	p	157	Ñ	214	ý
023	Ξ	068	D	113	q	158	ò	215	ù
024	Π	069	E	114	r	159	£	216	ň
025	Σ	070	F	115	s	160	¥	217	˘
026	Υ	071	G	116	t	161	°	218	˘
027	Φ	072	H	117	u	162	Γ	219	ř
028	Ú	073	I	118	v	163	J	224	*
029	Ú	074	J	119	w	164	˘	225	§
030	Ö	075	K	120	x	165	·	226	Ø
031	Ó	076	L	121	y	177	Á	227	˘
032	(space)	077	M	122	z	178	Í	228	↑
033	!	078	N	123	{	180	Ā	229]
034	”	079	O	124		181	ā	230	[
035	#	080	P	125	}	182	Ē	231	”
036	\$	081	Q	126	β	183	ē	232	ä
037	%	082	R	127	ç	184	ī	233	ö
038	&	083	S	128	!!	185	î	234	ü
039	'	084	T	129	₁	186	ū	235	æ
040	(085	U	130	₂	187	ū	236	â
041)	086	V	131	₃	188	Ŋ	237	É
042	*	087	W	132	₄	189	ŋ	238	ñ
043	+	088	X	133	1/2	190	Č	253	*(DC)
044	,	089	Y	134	F_T	191	Š		
045	-	090	Z	135	←	192	Ç		

*(DC): Double-size character code

: The shaded character cannot be displayed (displayed as space).

Note The character “!!” (code 128) cannot be displayed (displayed as “!”).

■ Department text (item label)

Procedure

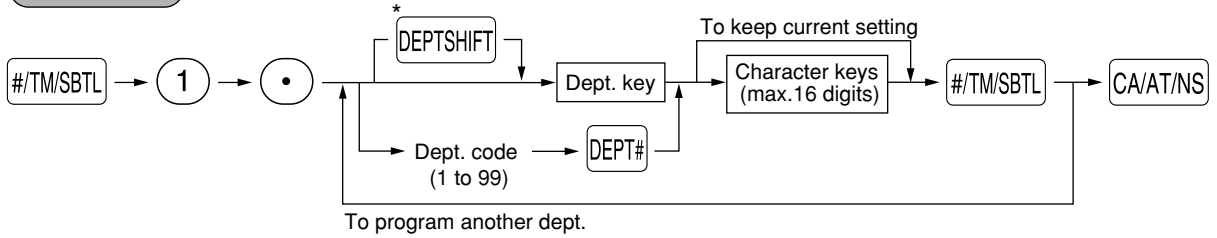

*To program departments 21 through 40, press the department shift key.

Key operation example

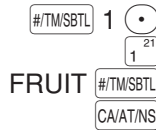

(Programming FRUIT for dept.1)

Print

PGM		
DO1	T1	0073
FRUIT		
GO CO		10.00

Text programmed for dept. 1

■ PLU/UPC text (item label)

Procedure

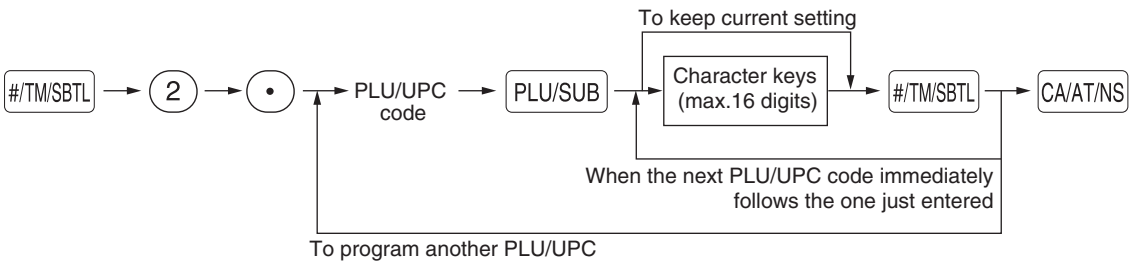

Key operation example

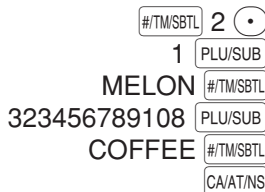

(Programming MELON to PLU1 and COFFEE to UPC code 323456789108)

Print

PGM		
P0001		(03)
MELON		1.25
		C1 0
323456789108#		(01)
COFFEE		3.60
		CO 1

Text programmed for PLU code 1

Text programmed for UPC code 323456789108

■ Function text

Procedure

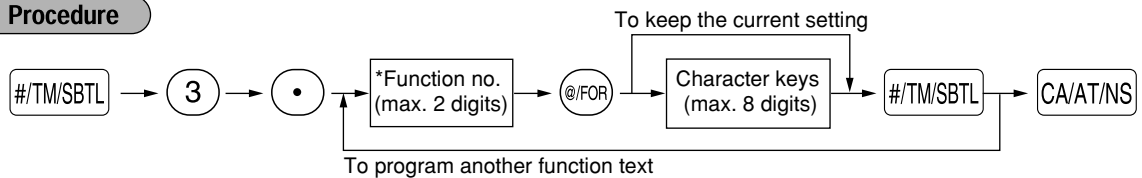

* Function no.: See "List of function texts" below.

Key operation example

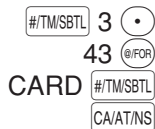

(Programming CARD for gross charge 1)

Print



■ List of function texts

Function no.	Key or function	Default setting	Function no.	Key or function	Default setting
1	⊖	(-)	28	Tax total	TTL TAX
2	%1	%1	29	Net	NET
3	%2	%2	30	Sales total including tax total	NET2
4	Net sales total	NET1	31	Refund	REFUND
5	Net taxable 1 subtotal	TAX1 ST	32	Item void	VOID
6	Gross tax 1 total	GRS TAX1	33	Void mode	VOID
7	Tax 1 total of refund entries	RFD TAX1	34	Manager void	MGR VD
8	Net tax 1 total	TAX1	35	Subtotal void	SBTL VD
9	Exempt tax 1	TX1 EXPT	36	No sale	NO SALE
10	Net taxable 2 subtotal	TAX2 ST	37	RA	*** RA
11	Gross tax 2 total	GRS TAX2	38	PO	*** PO
12	Tax 2 total of refund entries	RFD TAX2	39	Customer counter	TRANS CT
13	Net tax 2 total	TAX2	40	Sales total	NET3
14	Exempt tax 2	TX2 EXPT	41	Cash	CASH
15	Net taxable 3 subtotal	TAX3 ST	42	Check	CHECK
16	Gross tax 3 total	GRS TAX3	43	Gross charge 1	CHARGE
17	Tax 3 total of refund entries	RFD TAX3	44	Refund charge 1	CHARGE-
18	Net tax 3 total	TAX3	45	Gross charge 2	CHARGE2
19	Exempt tax 3	TX3 EXPT	46	Refund charge 2	CHARGE2-
20	Net taxable 4 subtotal	TAX4 ST	47	Currency conversion1 (Preset)	CONV 1
21	Gross tax 4 total	GRS TAX4	48	Currency conversion2 (Open)	CONV 2
22	Tax 4 total of refund entries	RFD TAX4	49	Cash in drawer	**** CID
23	Net tax 4 total	TAX4	50	Cash+check in drawer	CA+CH ID
24	Exempt tax 4	TX4 EXPT	51	Check change	CHK/CG
25	Gross manual tax total	GRS MTAX	52	Commission sale 1	COM. SAL1
26	Refund manual tax total	RFD MTAX	53	Commission sale 2	COM. SAL2
27	Net manual tax total	M-TAX	54	Non commission sale	NON COM.

Function no.	Key or function	Default setting
55	(+)Dept. total	*DEPT TL
56	(-)Dept. total	DEPT(-)
57	(+)Bottle return dept. total	*BTTL TL
58	(-)Bottle return dept. total	BTTL(-)
59	Subtotal	SUBTOTAL
60	Merchandise subtotal	MDSE ST
61	Total	*** TOTAL
62	Change	CHANGE
63	Items	ITEMS
64	Commission amount 1	COM. AMT1
65	Commission amount 2	COM. AMT2
66	Commission amount total	COM. TTL
67	Department report title	DEPT
68	PLU/UPC report title	PLU/UPC
69	Transaction report title	TRANS.
70	Clerk report title	CLERK
71	Hourly report title	HOURLY

Function no.	Key or function	Default setting
72	Daily report title	DAILY
73	Group report title	GROUP
74	Total in drawer	TL-ID
75	Non add symbol	#
76	Copy receipt title	COPY
77	Group 1	GROUP01
78	Group 2	GROUP02
79	Group 3	GROUP03
80	Group 4	GROUP04
81	Group 5	GROUP05
82	Group 6	GROUP06
83	Group 7	GROUP07
84	Group 8	GROUP08
85	Group 9	GROUP09
* 86	Change due	DUE
* 87	Taxable ST for all tax delete	TAX ST

Note The items marked with "*" are for display only.

■ Clerk names

Procedure

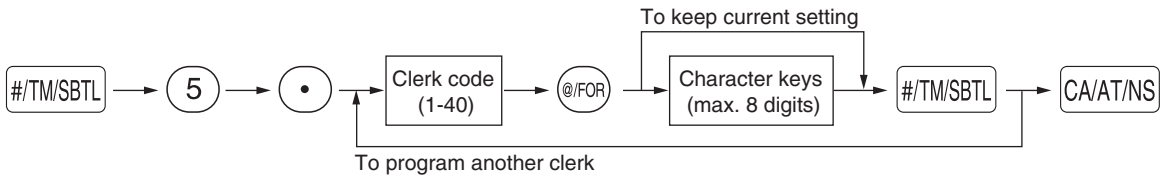

Key operation example



Print

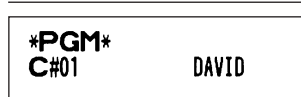

■ Logo messages

The register can print programmed messages on every receipt. On the standard model, the graphic logo is printed on the receipt. If you want to print logo messages, please change the logo message print format. (See page 57 for the programming details.) The options are listed below:

Procedure

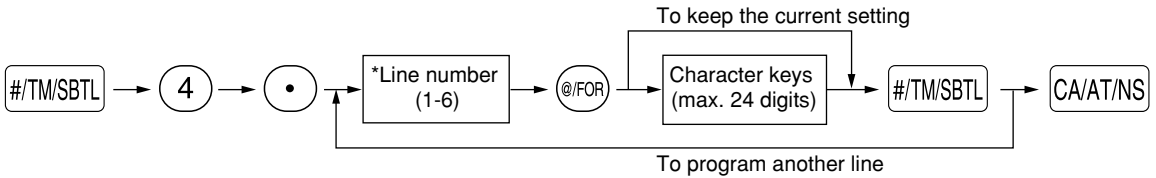

- * "Header 3-line message" type: 1 to 3
- "Footer 3-line message" type : 4 to 6
- "Header 6-line message" type: 1 to 6
- "Header 3-line and footer 3-line message" type: 1 to 6 (1 to 3 as header, 4 to 6 as footer)

Logo message print format (6 types)

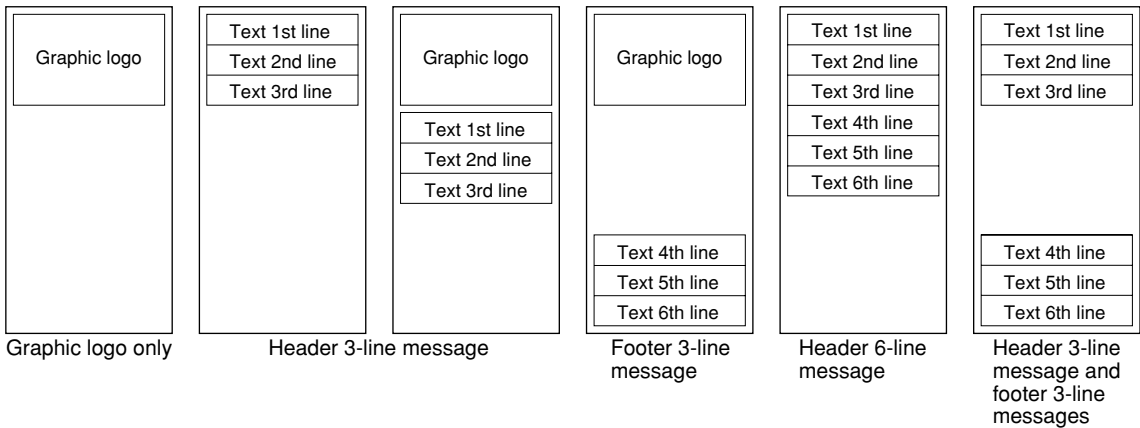

To print the logo message "THANK YOU" using double sized characters and centering on the third line.

Key operation example

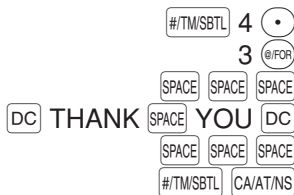

Print



Note

A 6-line logo message is pre-programmed when shipped. Begin entry from the first line when you initially program a logo message.

Foreign currency symbol

Foreign currency symbol for the `CLK#/CONV` key is printed with a foreign currency exchange amount.

Procedure

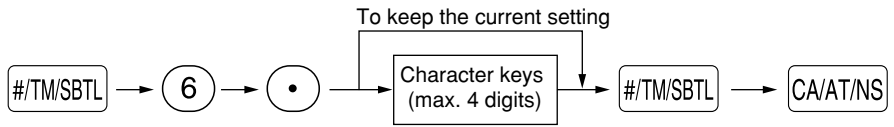

Key operation example

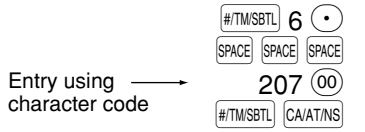

Print



Foreign currency symbol

ADVANCED PROGRAMMING

1 Register Number and Consecutive Number Programming

Register number and consecutive number are printed on every receipt and journal. When your store has two or more registers, it is practical to set separate register numbers for identification. The consecutive number is increased by one each time a receipt and/or journal is issued. For consecutive number programming, enter a number (max. 4 digits) that is one less than the desired starting number.

Register number

Procedure

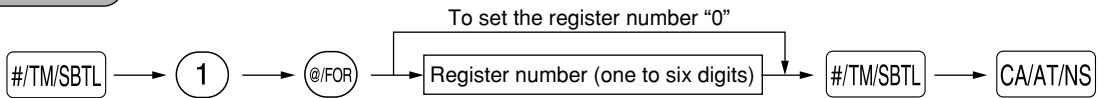

Key operation example

123456 #/TM/SBTL 1 @/FOR
#/TM/SBTL CA/AT/NS

Print

```

*PGM*
#1      123456
  
```

Register number

Setting consecutive numbers

Procedure

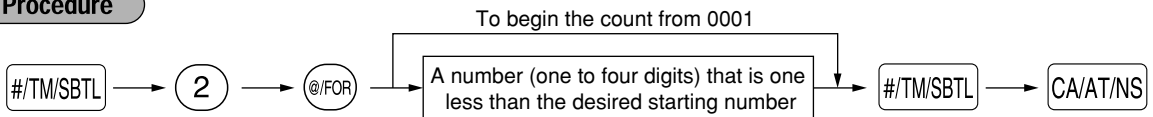

Key operation example

1000 #/TM/SBTL 2 @/FOR
#/TM/SBTL CA/AT/NS

Print

```

*PGM*
#2      1000
  
```

Consecutive number

2 Various Function Selection Programming 1

The cash register provides various detailed functions listed below.

- Function selection for miscellaneous keys
- Print format
- Receipt print format
- Function selection for tax
- Function selection for UPC codes
- Others

For this programming, the job code entry style is applied. You can continue programming until you press the CA/AT/NS key for the programming described in this section. To continue programming, repeat from a job code entry.

Procedure

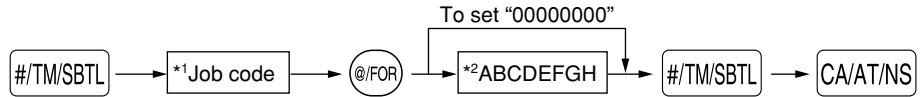

*1 Enter job code using numeric keys specified in each section below.

*2 Data entry details are listed on each table in each section below.

Example: When programming for job code 5 as ABCDEFGH: 00000100.

Key operation example

00000100 #/TM/SBTL 5 @/FOR
#/TM/SBTL CA/AT/NS

Print

```

*PGM*
#5 00000100
  
```

Function selection for miscellaneous keys

Job code: 5

* Item:	Selection:	Entry:
A PO in REG mode	Allow the PO operation in REG mode*	0
	Disallow it	1
B RA in REG mode	Allow the RA operation in REG mode*	0
	Disallow it	1
C Subtotal void in REG mode	Allow the REG mode subtotal void*	0
	Disallow it	1
D Indirect void in REG mode	Allow the REG mode indirect void*	0
	Disallow it	1
E Direct void in REG mode	Allow the REG mode direct void*	0
	Disallow it	1
F Refund key availability	Allow the REG mode refund entry*	0
	Disallow it	1
G No sale in REG mode	Allow the no sale operation in REG mode*	0
	Disallow it	1
H Fractional quantity availability	Allow fractional quantity entry	0
	Disallow it*	1

Print format

Job code: 6

* Item:	Selection:	Entry:
A Always enter 0.	(Fixed position)	0
B Always enter 0.	(Fixed position)	0
C Time print on all receipts/journals	Allow time printing*	0
	Disallow it	1
D Date print on all receipts/journals	Allow date printing*	0
	Disallow it	1
E Consecutive no. print on all receipts/journals	Allow consecutive no. printing*	0
	Disallow it	1
F Always enter 0.	(Fixed position)	0
G Zero skip for PLU/UPC report	Disallow zero skip	0
	Allow zero skip*	1
H Zero skip for full sales, clerk, hourly and daily net reports	Disallow zero skip	0
	Allow zero skip*	1

■ Receipt print format

Job code: 7

* Item:	Selection:	Entry:
A Always enter 0.	(Fixed position)	0
B Always enter 0.	(Fixed position)	0
C Subtotal print with a press of subtotal key	Disallow subtotal printing*	0
	Allow it	1
D Merchandise subtotal print with a press of merchandise subtotal key	Disallow merchandise subtotal printing*	0
	Allow it	1
E Always enter 0.	(Fixed position)	0
F Always enter 0.	(Fixed position)	0
G Always enter 0.	(Fixed position)	0
H Number of purchases print	Allow printing of number of purchases*	0
	Disallow it	1

■ Function selection for tax

Job code: 15

* Item:	Selection:	Entry:
A Always enter 0.	(Fixed position)	0
B Always enter 0.	(Fixed position)	0
C Always enter 0.	(Fixed position)	0
D Always enter 0.	(Fixed position)	0
E Always enter 0.	(Fixed position)	0
F Always enter 0.	(Fixed position)	0
G Tax delete in REG mode availability	Allow tax delete in REG mode*	0
	Disallow it	1
H Manual tax entry in REG mode availability	Allow manual tax entry in REG mode*	0
	Disallow it	1

■ Function selection for UPC codes

Job code: 16

* Item:	Selection:	Entry:
A Always enter 0.	(Fixed position)	0
B Always enter 0.	(Fixed position)	0
C Dept./PLU/UPC codes printing on journal	Disallow Dept./PLU/UPC codes printing on journal*	0
	Allow it	1
D Dept./PLU/UPC codes printing on receipt	Disallow Dept./PLU/UPC codes printing on receipt*	0
	Allow it	1
E UPC learning function	Allow UPC learning function*	0
	Disallow it	1
F Price entry after ISBN or ISSN codes	Compulsory price entry*	0
	Inhibit price entry	1
G PLU/UPC price look-up at refund entry	Allow PLU/UPC price look-up*	0
	Disallow it	1
H C/D(check digit) check for UPC codes	Disallow C/D check*	0
	Allow it	1

Price entry after ISBN or ISSN codes

When you set to “compulsory price entry”, the register requires a price entry when an ISBN or ISSN code is entered.

When you set to “Inhibit price entry”, ISBN and ISSN codes cannot be entered.

■ Other programming

Job code: 61

* Item:	Selection:	Entry:	
A	Always enter 0. (Fixed position)	0	
B	Always enter 0. (Fixed position)	0	
C	Minus dept./PLU/UPC availability	Disallow to program minus dept./PLU/UPC Allow it*	0 1
D	Fractional treatment	Round off (4 down, 5 up)* Raising to unit Disregarding fractional treatment	0 1 2
E	Use of ⓪ key	Use ⓪ key as 00 key* Use ⓪ key as 000 key	0 1
F	Time format	Use 12-hour format* Use 24-hour format	0 1
G	Date format	Use month-day-year format* Use day-month-year format Use year-month-day format	0 1 2
H	Position of decimal point (from right) (TAB)		0 to 3 (default 2)

Job code: 62

* Item:	Selection:	Entry:	
A	Always enter 0. (Fixed position)	0	
B	Error beep activation	By lock error* By misoperation	0 1
C	Key touch sound availability	Allow to sound* Disallow it	0 1
D	Buffered keyboard	Yes* No	0 1
E	Void mode operation availability	Allow void mode operation* Disallow it	0 1
F	Void mode entry data print in Z2 reports	Allow printing of void mode entry data in Z2 reports* Disallow it	0 1
G	Void mode entry data print in Z1 reports	Allow printing of void mode entry data in Z1 reports* Disallow it	0 1
H	Addition of hourly sales total data in void mode	No* Yes	0 1

Job code: 66

* Item:	Selection:	Entry:	
A	Printing a receipt after transaction	Total only Details*	0 1
B	Amount printing when PLU/UPC unit price is zero	Disallow printing* Allow it	0 1
C	Subtotal printing for conversion of deficit	Allow printing* Disallow it	0 1
D	Always enter 0. (Fixed position)		0
E	Always enter 0. (Fixed position)		0
F	Always enter 0. (Fixed position)		0
G	Logo message printing on journals	Disallow logo message printing on journals* Allow logo message printing on journals	0 1
H	Footer printing	Printing footer on all receipts* Printing footer with selected function key at the time of finalization	0 1

Job code: 70

* Item:	Selection:	Entry:
A	Split pricing counting	Quantity*
		Package
B	Multiplication/split pricing entry availability	Allow multiplication entry only*
		Allow both of multiplication and split pricing
C	Always enter 0.	(Fixed position)
D	Always enter 0.	(Fixed position)
E	Always enter 0.	(Fixed position)
F	Always enter 0.	(Fixed position)
G	Always enter 0.	(Fixed position)
H	Always enter 0.	(Fixed position)

3 Various Function Selection Programming 2

The cash register provides various options so you can use the register to suit your sales needs. In this section, you can program the following features (parameters within parentheses indicates default setting):

- Power save mode (entering the power save mode after 30 minutes)
- Logo message print format (graphic logo only)
- High amount lockout (HALO) for cash in drawer (CID) (9999999.99) (sentinel) - When the cash in drawer reaches the amount programmed, the sentinel mark "X" will be displayed at the leftmost position on the lower line of the operator display.
- Thermal printer density (standard density)
- Online time out setting
- Language selection (English)
- Training clerk specification (none) - If you specify a clerk code who is trained for use on this cash register, the cash register will go into training mode when the clerk code is registered for sales entries. The sales operations done by the trained clerk do not affect sales totals. For details, refer to TRAINING MODE section.

Power save mode

Procedure

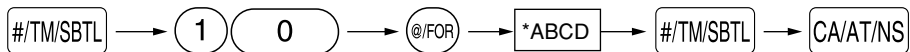

* Item:	Selection:	Entry:
A	Entering power save mode	Yes*
	when time is displayed	No
B-D	Time(min.) to entering power save mode since no operation is made	001-254 or 999 (Default 030)

Note When 999 is set for B to D, entering into power save mode is inhibited.

Key operation example

```

    #/TM/SBTL 10 @/FOR
    0060 #/TM/SBTL CA/AT/NS
  
```

Print

```

    *PGM*
    #10      0060
  
```

■ Logo message print format

You can select the number of lines for your logo message, and the position to print it on receipt. For details of the logo message type, please refer to “Logo messages” on page 50.

Procedure

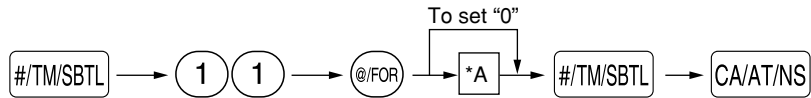

*A: Logo message type

- 0: Header 3-line message without graphic logo
- 1: Graphic logo only (default)
- 2: Footer 3-line message with graphic logo
- 3: Header 6-line message
- 4: Header 3-line message with graphic logo
- 5: Header 3-line message and footer 3-line message

Key operation example



Print



■ High amount lockout (HALO) for cash in drawer (CID) (sentinel)

Procedure

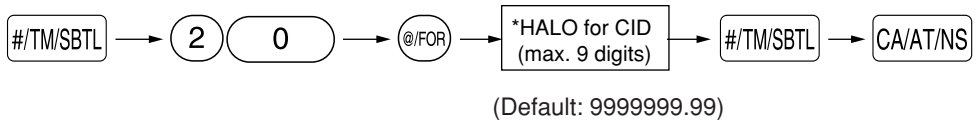

Key operation example



Print



■ Online time out setting

Procedure

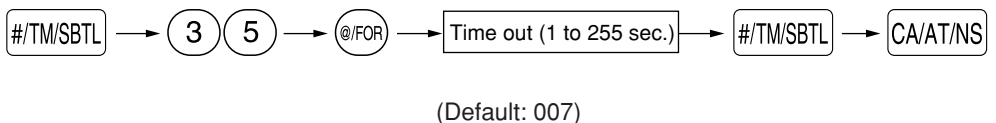

Key operation example



Print

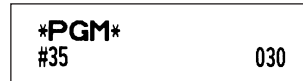

■ Thermal printer density

Procedure

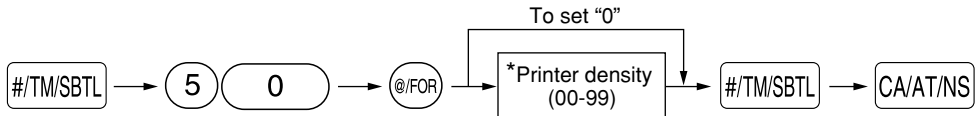

* By default, 50 is set. To make the print darker, set a larger number, and to make the print lighter, set a smaller number.

Key operation example

#/TM/SBTL 50 @/FOR
00 #/TM/SBTL CA/AT/NS

Print

PGM
#50 00

■ Language selection

Procedure

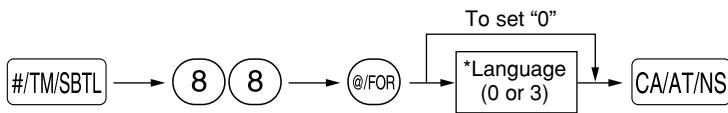

*Language: 0: English 3: Spanish

Key operation example

#/TM/SBTL 88 @/FOR
3 CA/AT/NS

Print

PGM
#88 3

Caution

When you change the language, the text such as clerk name, logo message and function text will be reset to the default settings.

■ Training clerk specification for training mode

For the details of clerk training, please refer to "TRAINING MODE" on page 61.

Procedure

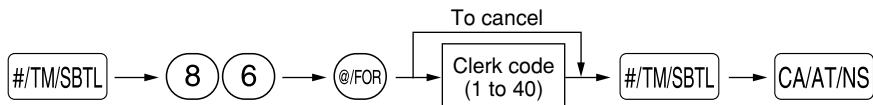

Key operation example

#/TM/SBTL 86 @/FOR
40 #/TM/SBTL CA/AT/NS

Print

PGM
#86 40

■ AUTO key programming — Automatic sequence key

If you program frequently performed transactions or report sequences for the **AUTO** key, you can call those transactions and/or reports simply by pressing the **AUTO** key in key operations.

Procedure

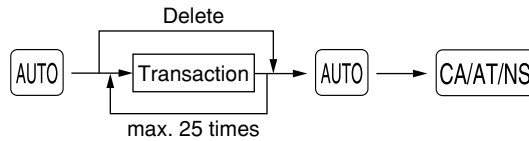

Programming for **AUTO**; entering a PLU 2 item (programmed unit price: 1.50) and a dept. 6 item (unit price: 1.00)

Key operation example

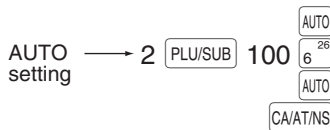

Print

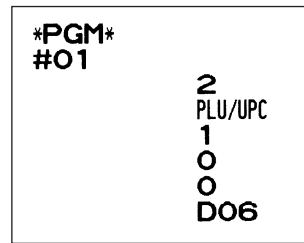

Note

When the **AUTO** key has been programmed to execute a report job function etc., the mode switch must be in the appropriate position (REG, MGR, OPX/Z, X1/Z1 or X2/Z2).

4 Reading Stored Programs

The machine allows you to read every program stored in the PGM mode.

■ Key sequence for reading stored program

Report name	Key sequence
Programming report 1	CA/AT/NS
Programming report 2	② → CA/AT/NS
Auto key programming report	① → CA/AT/NS
Printer density programming report	③ → CA/AT/NS
PLU/UPC programming report (Range)	Start PLU/UPC code → (R/FOR) → End PLU/UPC code → PLU/SUB When reading one PLU/UPC code only
(All)	PLU/SUB

Note

To stop reading PLU/UPC programming report, turn the mode switch to the MGR position.

Sample printouts

1 Programming report 1

PGM			Mode
DO1	T1	0071	Dept. code
DEPT. 01			Dept. text
GO CO		0.00	Dept. unit price w/sign
DO2	T1	0071	Dept. function
DEPT. 02			
G1 C1		-0.00	Minus department
DO3	T1	0071	Tax status
DEPT. 03			
GO CO		0.00	Dept. group & commission group

D99		0071	Function no.& its text
DEPT. 99			
GO CO		0.00	Tax status
F01 (-)		006	Function parametrs (F-H)
	T1	-2.00	Discount amt. w/sign
F02 %1		000	Function parametrs (F-H)
L100.00%		-10.25%	Percent rate with sign
F03 %2		000	Function parametrs (F-H)
L100.00%		-0.00%	Percent limit
F04 NET1			
F05 TAX1 ST			

F26 RFD MTAX			
F27 M-TAX	7		Entry digit limit
F28 TTL TAX			

F36 NO SALE			
F37 ***RA	9		Entry digit limit
F38 ***PO	4		Entry digit limit
F39 TRANS CT			
F40 NET3			
F41 CASH	008		Function parameters (A-C)
F42 CHECK	018		Function parameters (A-C)
F43 CHARGE	008		Function parameters (A-C)
F44 CHARGE-			
F45 CHARGE2	008		Function parameters (A-C)
F46 CHARGE2-			
F47 CONV 1	00		Function parameters
€	0.8063		Foreign currency symbol/Rate
F48 CONV 2			
F49 ****CID			
F50 CA+CH ID			
F51 CHK/CG			
F52 COM. SAL1	15.00%		Commission rate
F53 COM. SAL2	0.00%		Commission rate
F54 NON COM.			
F55 *DEPT TL			

F86 DUE			
F87 TAX ST			
YOUR RECEIPT THANK YOU PLEASE VISIT US AGAIN			Logo Message
#5	00000001		Function selection for miscellaneous keys (A-H)
#6	00000011		Print format (A-H)
#7	00000000		Receipt print format(A-H)
#10	0030		Power save mode(A-D)
#11	3		Logo message print format
#15	00000000		Function selection for tax (A-H)
#16	00000000		Function selection for UPC codes
#20	9999999.99		HALO for CID (sentinel)
#35	007		Online time out
#50	99		Thermal printer density
T1	6.0000%		
	/ 1.00		
	1 0.11		Tax table
	2 0.23		
	3 0.39		
	4 0.57		
	5 0.73		
	6 0.89		
	7 1.11		
T2	4.0000%		Tax rate
	0.12		Min. taxable amount
T3	-----		
T4	-----		
C#01	CLERK01		Clerk code/name
C#02	CLERK02		Clerk code/name
C#39	CLERK39		
C#40	CLERK40		

2 Programming report 2

PGM		
#61	00100002	Job code
#62	00000000	
#63	01010001	A to H from the left
#64	00000000	
#65	00000000	* Job code #63, 64, 65, 67, 68, 69, 71, 72, 76, 77, 85, 87 and 95 are fixed settings, for which you cannot change the settings.
#66	10000000	
#67	00000000	
#68	00000000	
#69	00100000	
#70	00000000	
#71		
GT2	\$0000000000.00	
#72		
GT3	\$0000000000.00	
#76	Z1 0000	
#77	Z2 0000	
#85	\$	
#86	40	Training clerk specification
#87	TRAINING	
#88	0	Language selection
#95	99	

4 Printer density programming report

PGM		
#50	00	Entered value Printer density
10	: 0123456789AB	Printing density example
20	: 0123456789AB	
30	: 0123456789AB	
40	: 0123456789AB	
50	: 0123456789AB	
60	: 0123456789AB	
70	: 0123456789AB	
80	: 0123456789AB	
90	: 0123456789AB	

5 PLU/UPC programming report

PGM			
	0001-999999	Range	
PLU code	P0001	(03)	Associated dept. code
PLU text	MELON	1.25	Commission group
		C1 0	Mode parameter
	P0002	(01)	Unit price
	PLU0002	2.00	
		C0 1	
	P0020	(01)	
	PLU0020	0.00	
		C0 1	
UPC code	5012345678900#	(01)	
UPC text	MILK	1.50	
		C0 1	
	323456789108#	(01)	
	COFFEE	3.60	
		C0 1	

3 Auto key programming report

PGM	
#01	
	2
	PLU/UPC
	1
	0
	0
	DO6

The UPC codes are printed out in the order of EAN-13, EAN-8, UPC-A and UPC-E.

TRAINING MODE

Training mode is used when the operator or the manager practices register operations.

When a clerk in training is selected, the machine automatically enters training mode. To specify a clerk to be trained, refer to "Training clerk specification for training mode" in the "ADVANCED PROGRAMMING" in page 58. The training operation is valid only in REG, MGR and VOID mode.

The corresponding clerk memory is only updated in training mode.

Key operation example

A clerk set in training → 40 CLK#/CONV
 1000 25
 5
 3 0/FOR
 3 20
 CA/AT/NS

Receipt print

01/26/2010	4:31PM	40
123456#1108		CLERK40
TRAINING		
DEPT. 05	T1	\$10.00
	3 @	\$24.00
DEPT. 03	T1	\$72.00
MDSE ST		\$82.00
TAX1		\$5.13
ITEMS	40	
CASH		\$87.13

READING (X) AND RESETTING (Z) OF SALES TOTALS

- Use the reading function (X) when you need to take a reading of sales information entered since the last reset. You can take this reading any number of times. It does not affect the register's memory.
- Use the resetting function (Z) when you need to clear the register's memory. Resetting prints all sales information and clears the entire memory except for the GT1 through GT3, Training GT, reset count, and consecutive number.

1 Summary of Reading (X) and Resetting (Z) Reports

X1 and Z1 reports: Daily sales reports

X2 and Z2 reports: Periodic (monthly) consolidation reports

When you take an X or Z report, turn the mode switch to the appropriate position referring to the column of "Mode switch position" shown on the table below, and use the following corresponding key sequence.

Item	Mode switch position			Key operation
	OPX/Z	X1/Z1	X2/Z2	
Flash report: (Only display) To clear the display, press the CL key or turn the mode switch to another position.	X	—	—	Dept. code → DEPT# : Department total amount [For dept. 1 to 20; Dept. key (1 ²¹ to 20 ⁴⁰) For dept. 21 to 40; DEPTSHIFT → Dept. key (1 ²¹ to 20 ⁴⁰)] @/FOR key: Amount of cash in drawer CA/AT/NS key: Sales total
Full sales report	—	X1, Z1	X2, Z2	Reading: CA/AT/NS Resetting: • → CA/AT/NS
Department report	—	X1	X2	Reading: DEPT#
Individual group total report on department	—	X1	X2	Reading: Group number → @/FOR → DEPT#
Full group total report on department	—	X1	X2	Reading: 0 → @/FOR → DEPT#
PLU/UPC report by designated range	—	X1, Z1	X2, Z2	All PLU/UPCs Reading: Start PLU/UPC code → @/FOR → End PLU/UPC code → PLU/SUB Resetting: Start PLU/UPC code → @/FOR → End PLU/UPC code → • → PLU/SUB
PLU/UPC report by associated department	—	X1	X2	Reading: Associated dept. code → DEPTSHIFT → PLU/SUB
Transaction report	—	X1	X2	Reading: 1 → CA/AT/NS

Item	Mode switch position			Key operation
	OPX/Z	X1/Z1	X2/Z2	
Total in drawer report	—	X1	X2	Reading: ② → CA/AT/NS
Individual clerk report	X, Z	—	—	Reading: CLK#/CONV Resetting: ● → CLK#/CONV (The report of the current clerk)
Full clerk report	—	X1, Z1	X2, Z2	Reading: CLK#/CONV Resetting: ● → CLK#/CONV
Hourly report (full)	—	X1, Z1	—	Reading: #/TM/SBTL Resetting: ● → #/TM/SBTL
Hourly report (by range)	—	X1	—	Reading: Start time (hour) → @/FOR → End time (hour) → #/TM/SBTL
Daily net report	—	—	X2, Z2	Reading: #/TM/SBTL Resetting: ● → #/TM/SBTL

Note

- When both sales quantities and sales amounts are zero, printing is skipped. If you do not want to skip, change the programming. (Refer to “Print format” of “Various Function Selection Programming 1”.)
- “X” represents read symbol and “Z” represents reset symbol in the reports.
- To stop reading and resetting the PLU/UPC sales report, turn the mode switch to the MGR position. The data will not be erased when you reset.

2 Daily Sales Totals

Full sales report

Sample report

Z1	Z1 0001	Mode title*1
		Reset counter
GT1	\$00000002175.36	Net grand total(GT2-GT3)
GT2	\$00000002436.24	Grand total of plus registration
GT3	-00000000260.88	Grand total of minus registration
TR	\$00000000310.96	Grand total of training mode registration
DEPT		Dept. code
D01	58Q	Sales q'ty
DEPT. 01	\$369.09	Sales amount
D02	4Q	
DEPT. 02	\$118.36	
D03	1Q	
DEPT. 03	\$12.50	
D99	3Q	
DEPT. 99	\$28.26	
*DEPT TL	274Q	"+" dept. counter and total
	\$2232.41	
D38	12Q	
DEPT. 38	-115.51	
DEPT (-)	12Q	"-" dept. counter and total
	-115.51	
D39	10Q	
DEPT. 39	\$3.00	
*BTTL TL	10Q	"+" bottle return dept. counter and total
	\$3.00	
D40	4Q	
DEPT. 40	-1.20	
BTTL (-)	4Q	"-" bottle return dept. counter and total
	-1.20	
* TRANS. *		
(-)	2Q	Subtotal ⊖ counter and total
	-1.86	
%1	1Q	Subtotal percent 1 counter and total
	-1.13	
%2	2Q	
	\$0.47	
NET 1	\$2116.18	Net sales total
TAX1 ST	\$827.49	Taxable 1 total
GRS TAX1	\$61.43	Gross tax 1 total
RFD TAX1	-6.70	Refund tax 1 total
TAX1	\$54.73	Net tax 1 total
TX1 EXPT	\$7.25	
TAX2 ST	\$42.30	
GRS TAX2	\$1.70	
M-TAX	\$2.75	Manual tax total
TTL TAX	\$59.18	Tax total
NET	\$2116.18	Net total without tax
NET2	\$2175.36	Net total with tax
(-)	2Q	Item ⊖ counter and total
	-3.25	
%1	1Q	Item percent 1 counter and total
	-0.60	
%2	1Q	
	\$0.75	
VOID	12Q	REG-mode void counter and total
	\$72.95	
SBTL VD	3Q	Subtotal void counter and total
	\$93.50	
MGR VD	3Q	Manager item void counter and total
	\$13.28	
VOID	2Q	Void-mode transaction counter and total
	\$13.28	
REFUND	10Q	Refund counter and total
	\$44.40	
***RA	1Q	Received on account counter and total
	\$48.00	
***PO	1Q	Paid out counter and total
	\$25.00	
NO SALE	6Q	No-sales counter
TRANS CT	79Q	Customer counter
NET3	\$2175.36	Sales total
CASH	68Q	Cash counter and total
	\$2029.87	
CHECK	4Q	Check sales counter and total
	\$70.78	
CHARGE	4Q	Charge1 sales counter and total
	\$119.97	
CHARGE-	2Q	Charge1 refund counter and total
	-46.36	
CHARGE2	1Q	
	\$40.00	
CHARGE2-	1Q	
	-26.56	
CONV 1	100.00	Foreign currency total (preset)
CONV 2	194.15	Foreign currency total (open)
****CID	\$1812.80	Cash in drawer
CA+CH ID	\$1883.58	Cash + check in drawer
CHK/CG	\$12.34	Change total for check tendering

*1: When you take X1 report, "X1" is printed.

*2: Printed in the Z1 report only.

■ Department report

• Sample report

*X1 *		Mode title
DEPT		Report title
D01	58Q	
DEPT. 01	\$369.09	
D02	4Q	
DEPT. 02	\$118.36	
D03	1Q	
DEPT. 03	\$12.50	
D04	1Q	
DEPT. 04	\$2.36	
D05	4Q	
DEPT. 05	\$5.60	
D99	3Q	
DEPT. 99	\$28.26	
*DEPT TL	274Q	
	\$2232.41	
D38	12Q	
DEPT. 38	-115.51	
DEPT (-)	12Q	
	-115.51	
D39	10Q	
DEPT. 39	\$3.00	
*BTTL TL	10Q	
	\$3.00	
D40	4Q	
DEPT. 40	-1.20	
BTTL (-)	4Q	
	-1.20	

■ Individual group total report on department

• Sample report

*X1 *		Mode title
* GROUP *		Report title
D01	58Q	
DEPT. 01	\$369.09	
D02	4Q	
DEPT. 02	\$118.36	
D04	1Q	
DEPT. 04	\$2.36	
D09	4Q	
DEPT. 09	\$30.90	
D10	2Q	
DEPT. 10	\$25.00	
GROUP01	69Q	
	\$545.71	} Group 1 total

■ Full group total report on department

• Sample report

*X1 *		Mode title
* GROUP *		Report title
GROUP01	69Q	} Group 1 total
	\$545.71	
GROUP02	43Q	
	\$481.75	
GROUP03	79Q	
	\$530.75	
GROUP04	0Q	
	\$0.00	
GROUP07	0Q	
	\$0.00	
GROUP08	23Q	
	\$68.25	
GROUP09	17Q	
	\$255.00	

■ PLU/UPC report by designated range

• Sample report

*X1 *		Mode title*
*PLU/UPC *		Report title
	0001-999999	} Range
PLU		} Sales q'ty and total
P0001	13Q	
MELON	\$42.25	
P0002	9Q	
PLU0002	\$13.50	
P0035	8Q	} PLU range sum
PLU0035	\$6.67	
***TOTAL	66Q	
	\$256.27	
UPC		} UPC range sum
4901305920795#	9Q	
NOTEBOOK	\$43.20	
323456789108#	15Q	} UPC range sum
COFFEE	\$54.00	
***TOTAL	33Q	
	\$124.70	

*: When you take Z1 report, "Z1" is printed.

The UPC codes are printed out in the order of EAN-13, EAN-8, UPC-A and UPC-E.

■ PLU/UPC report by associated department

• Sample report

	X1		Mode title
	*PLU/UPC *		Report title
	DEPT. 01	DO1	Associate dept. code
PLU code	PLU		
	P0010	1Q	} Sales qty and total
	PLU0010	\$7.15	
	P0021	24Q	
	PLU0021	\$54.70	
	P0035	8Q	
	PLU0035	\$6.67	
	***TOTAL	33Q	} PLU total
		\$68.52	
UPC code	UPC		
	4901305920795#	9Q	} UPC total
	NOTEBOOK	\$43.20	
	5012345678900#	5Q	
	MILK	\$7.50	
	***TOTAL	14Q	
		\$50.70	

■ Clerk reports

Individual clerk report

• Sample report

	OPX		Mode title*
	* CLERK *		Report title
	O1 #	CLERK01	Clerk code
	TRANS CT	49Q	Clerk name
	NET3	\$873.14	Customer counter
	****CID	\$803.14	Sales total
	CA+CH ID	\$873.14	
	CHK/CG	\$6.53	
	NET	\$824.95	Net sales
	COM. SAL1	\$151.22	Commission 1 sales total
	COM. AMT1	\$15.12	Commission 1 amount
	COM. SAL2	\$219.00	
	COM. AMT2	\$32.85	
	COM. TTL	\$47.97	Commission amount total
	NON COM.	\$454.73	Non commission sales total

*: When you take OPZ report, "OPZ" is printed.

Full clerk report

The report prints in the same format as in the sample report of individual clerk, but all clerk's sales data is sorted by clerk code # (from #1 to #40).

■ Transaction report

• Sample report

X1	Mode title
* TRANS. *	Report title

↓

This report shows the same transaction data as when a full sales report is run.

■ Hourly report

• Sample report

X1	Mode title*
* HOURLY *	Report title
10:00AM	12Q
	\$119.98
11:00AM	18Q
	\$186.89
12:00PM	25Q
	\$202.91
5:00PM	18Q
	\$126.69
6:00PM	16Q
	\$92.26

*: When you take Z1 report, "Z1" is printed.

When you take an hourly report by range, a report of the specified range of time (hour) is printed.

■ Total in drawer report

• Sample report

X1	Mode title	
* TL-ID *	Report title	
****CID	\$1812.80	Cash in drawer
CA+CH ID	\$1883.58	Cash plus check in drawer

3 Periodic Consolidation

■ General information

The periodic reading or resetting reports are the same in format as those in the X1/Z1 report for daily sales. The mode indicator will read "X2" or "Z2".

• **Sample X report**
(Individual group total report on department)

```
*X2* _____ Mode title
* GROUP * _____ Report title
```

• **Sample Z report**
(Full sales report)

```
*Z2* _____ Mode title
                Z1 0002 Reset counter of daily total
                Z2 0001 Reset counter of
                        periodic consolidation
GT1 $00000003048.50
GT2 $00000003309.38
GT3 -00000000260.88
TR  $00000000310.96
                        Grand totals
```

The subsequent printouts are the same in format as those in the X/Z report for daily totals.

■ Daily net report

• **Sample report**

```
*X2* _____ Mode title*
* DAILY * _____ Date
09/01 53Q Customer counter
      $1732.00 Sales total
09/02 64Q
      $2146.00
09/03 58Q
      $1384.53

09/29 61Q
      $2163.50
09/30 59Q
      $1935.31

***TOTAL 1298Q Customer total
          $44761.34 Net amount total
```

*: When you take Z report, "Z2" is printed instead of "X2".

OVERRIDE ENTRIES

Programmed limit for functions (such as for maximum amounts) can be overridden by making an entry in the MGR mode.

Procedure

1. Turn the mode switch to the MGR position.
2. Make an override entry.

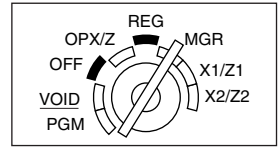

Example

In this example, the register has been programmed not to allow discounts entries over \$1.00.

Key operation example

REG-mode 1500 ²³
 entries 250 ...Error

Turn the mode switch to the MGR position.

250

Return the mode switch to the REG position.

Receipt print

DEPT. 03	T1	\$15.00
(-)		-2.50
MDSE ST		\$12.50
TAX1		\$0.94
ITEMS	1Q	
CASH		\$13.44

CORRECTION AFTER FINALIZING A TRANSACTION (Void mode)

When you need to void incorrect entries that clerks cannot correct (incorrect entries found after finalizing a transaction, or a transaction that cannot be corrected by direct or indirect void), follow this procedure:

1. Turn the mode switch to the VOID position using the manager key (MA). The cash register will enter the void mode and the backlight display will turn red.
2. Repeat the entries that are recorded on the incorrect receipt. (All data on the incorrect receipt is removed from register memory; the voided amounts are added to the void-mode transaction totalizer.)

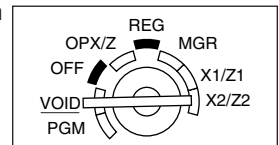

Incorrect receipt

DEPT. 04	T1	\$10.00
DEPT. 03	T1	\$1.50
MDSE ST		\$11.50
TAX1		\$0.72
ITEMS	2Q	
CASH		\$12.22



Cancellation receipt

VOID		
DEPT. 04	T1	\$10.00
DEPT. 03	T1	\$1.50
MDSE ST		\$11.50
TAX1		\$0.72
ITEMS	2Q	
CASH		\$12.22

HOW TO USE AN SD MEMORY CARD

1 What You Can Do with an SD Memory Card

You can exchange data through an SD memory card between your cash register and a PC when managing the data in your cash register by using SHARP's PC software "Customer Support Tool."

Customer Support Tool can be downloaded from the Sharp web site.

Please visit the Sharp web site: <http://www.sharppusa.com/registersoftware>

You can also save all necessary data in the cash register to an SD memory card for backup.

This instruction manual describes only those operations needed on the cash register. For details, please refer to the help section in the "Customer Support Tool".

List of functions

- All data backup:** With this function you can save all the sales data and programming data in the cash register to an SD memory card for backup. By loading the data saved to the SD memory card into the cash register you can restore to its original state, if necessary.
- Programming data:** With this function you can write all the programming data in the cash register onto an SD memory card. You can manage this data on a PC by using the "Easy Programming Tool" contained in the Customer Support Tool. You can also load the programming data edited with the "Easy Programming Tool" into the cash register through an SD memory card.
- Graphic logo:** With this function you can load the graphic logo data created with the "Easy Programming Tool" into the cash register through an SD memory card.
- Sales data:** With this function you can write all the sales data of daily and periodic totals in the cash register onto an SD memory card. You can manage the data on a PC by using the "Sales Total Reporting" contained in the Customer Support Tool.

Recommended SD memory cards

We recommend you to use the SD memory cards made by SanDisk Corporation. If you want to know the SD memory card in detail, please visit the Sharp web site: <http://www.sharppusa.com>.

Note

- The data stored in an SD memory card could be lost or distorted due to accidents or other issues. Sharp is not responsible for any damage incurred by lost data.
- Only the FAT(FAT16) formatted SD memory card is available on your cash register. If you have a SD memory card formatted with FAT32, please format it to FAT16 using Windows PC and then reformat it on your cash register before you use.
- 128-Mbyte to 2-Gbyte SD memory cards are available and the relationship between the memory card capacity and the maximum holding period of sales data which can be saved in an SD memory card is as follows:

<u>Memory card capacity</u>	<u>Sales data holding period *</u>
128MB	6 Months
256MB (or 512MB)	1 Year
2GB/1GB	1 Year

*: This period refers to the time period during which sales data can be stored in an SD memory card when additionally written onto it once a day.

2 In Case of SD Error

If an error occurs while data is transferred from your cash register to the inserted SD memory card and vice versa, it will be indicated by a corresponding error message shown on the operator display. Press the (CL) key to clear the error, then take the corresponding action.

SD error message table

Display (Error message)	Error status and action
NO CARD	No SD memory card is found. Insert an SD memory card into the SD card slot or reinsert it correctly.
CARD PROTECT	The write-protect switch on the SD memory card is in the "PROTECTED" position. Set the switch on the "NOT PROTECTED" position.
CARD FULL	The SD memory card is full. Delete unwanted data from the card on a PC or replace the card with a new one. When using a new SD memory card, be sure to format it in advance.
ACCESS ERROR	The SD memory card has no desired data. Replace it with another SD memory card containing the desired data.
FILE FAILED	The data stored in the SD memory card is incorrect. Write correct data into the SD memory card on a PC.
OVER LIMIT.	The maximum allowable number of times of sales data writing is exceeded. Delete unwanted data from the SD memory card on a PC or replace the card with a new one. When using a new SD memory card, be sure to format it in advance.
POWER OFF	A power failure has occurred while the SD memory card is accessed. Perform the interrupted operation again from the beginning after power recovery.
SD CANCEL	The data transfer operation has been canceled. Perform the same operation again from the beginning.
SD ERROR	An error other than the above mentioned has occurred while the SD memory card is accessed. Perform the interrupted operation again from the beginning.

3 Inserting and Removing an SD Memory Card

The SD card slot is located on the right side of your cash register and has a cover.

Inserting an SD memory card

Insert an SD memory card into the SD card slot with the printed SD logo facing upwards. Push the card in steady with a finger until it clicks and release it slowly.

Removing the SD memory card

Push the card in gently with a finger and release it. The card will come out.

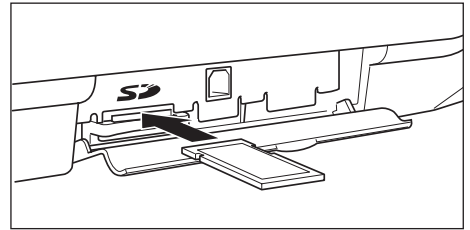

Note

- Be sure to check if the SD memory card has perfectly been inserted before closing the cover. If this instruction is not performed correctly, the card or SD card slot may be damaged.
- When inserting or removing the SD memory card, be sure to release it slowly. Otherwise, the card may pop out and injure your finger.
- Never touch or remove the SD memory card while it is accessed, otherwise the data stored in it may be damaged.
- If a power failure occurs, the cash register is unplugged, or the mode switch is turned to another position while the SD memory card is accessed, the data stored in that card could be damaged.

4 Formatting an SD Memory Card

When you use a new SD memory card for the first time, be sure to format it on your cash register before writing programming data etc. to it.

Never format any SD memory card that contains some data, otherwise all of the data stored on the card will be erased.

Procedure

Set the mode switch to the **PGM** position.

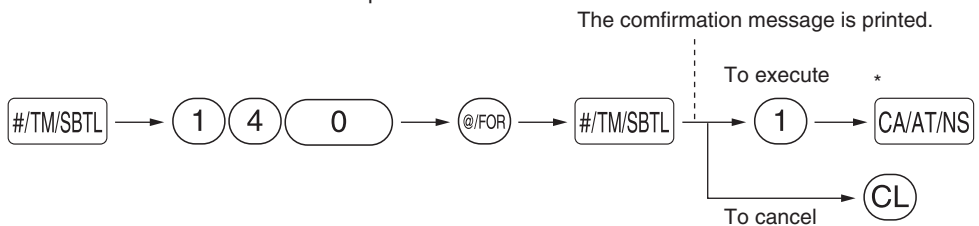

* The message "ACCESSING CARD" will appear and stay on the display until the SD memory card is completely formatted. When formatting is finalized, the message "SD FINAL" will be printed. In case an error occurs, a corresponding error message will be printed.

5 Saving and Restoring All the Data

Procedure Set the mode switch to the **PGM** position.

Saving (writing) all the data

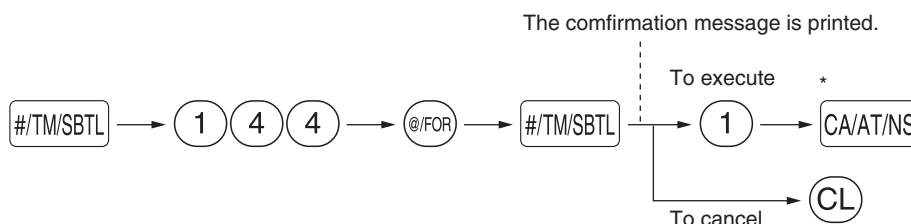

Restoring (reading) the saved data

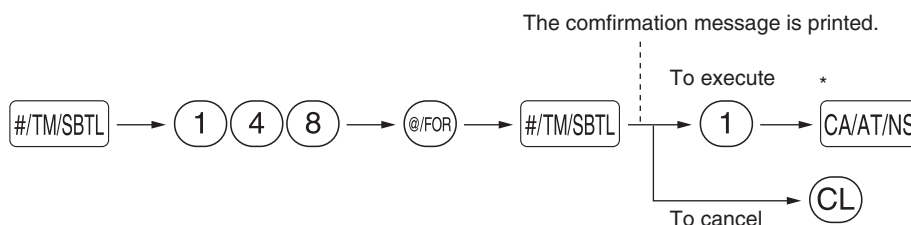

* The message “ACCESSING CARD” will appear and stay on the display until all data is completely written or read. When writing or reading is finalized, the message “SD FINAL” will be printed. In case an error occurs, a corresponding error message will be printed.

Note If you save all the data by using an SD memory card that contains some data, the existing data will be erased and replaced with newly saved data. If you need the existing data, use another SD memory card.

6 Writing and Reading of Programming Data

Reading the graphic logo data

Procedure Set the mode switch to the **PGM** position.

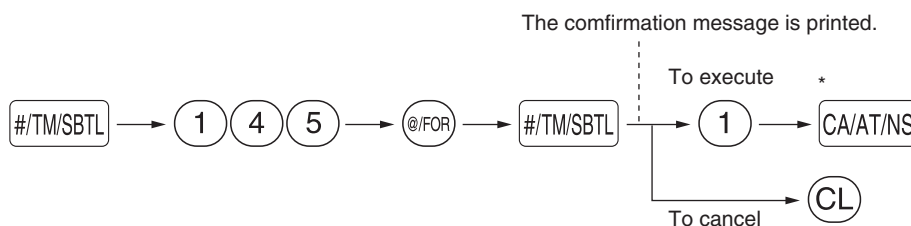

* The message “ACCESSING CARD” will appear and stay on the display until all data is completely read. When reading is finalized, the message “SD FINAL” will be printed. In case an error occurs, a corresponding error message will be printed.

■ Writing and reading all the programming data

You can write all the programming data in the cash register onto an SD memory card (Writing). The existing programming data in the card will all be replaced with the newly written data at this time.

You can also replace the programming data stored in the cash register with those stored in an SD memory card by loading the latter into the cash register(Reading).

Procedure

Set the mode switch to the **PGM** position.

Writing

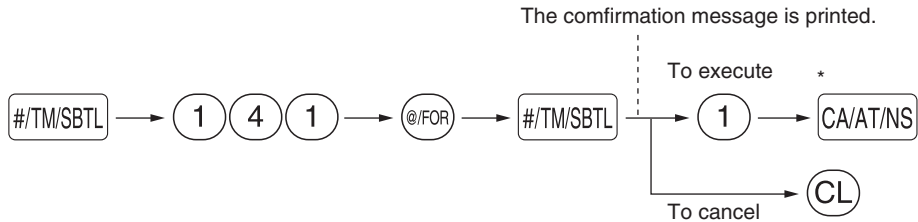

Reading

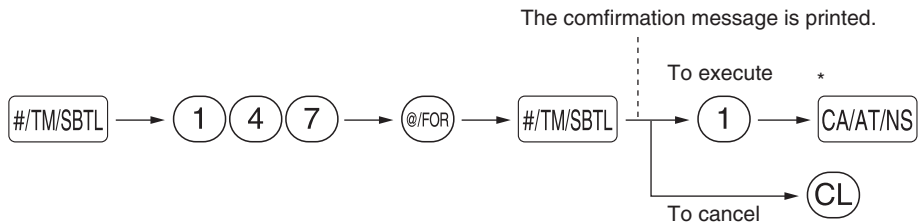

* The message "ACCESSING CARD" will appear and stay on the display until all data is completely written or read. When writing or reading is finalized, the message "SD FINAL" will be printed. In case an error occurs, a corresponding error message will be printed.

7 Writing of Sales Data

Write all of the existing sales data (daily and periodic totals) onto an SD memory card. You can write the data onto the same card a maximum of 400 times unless the card becomes full.

Procedure

Set the mode switch to the **X1/Z1** position.

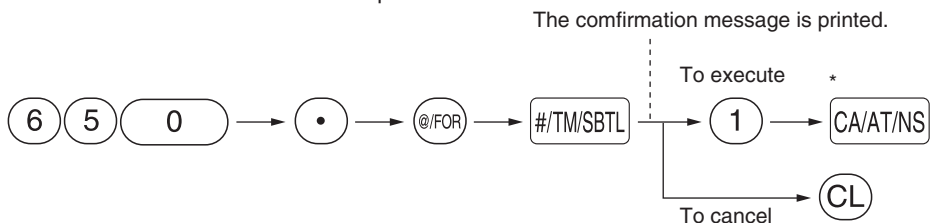

* The message "ACCESSING CARD" will appear and stay on the display until all data is completely written. When writing is finalized, the message "SD FINAL" will be printed. In case an error occurs, a corresponding error message will be printed.

OPERATOR MAINTENANCE

1 In case of Power Failure

When power is lost, the machine retains its memory contents and all information on sales entries.

- When a power failure is encountered in register idle state or during an entry, the machine returns to normal operation after power recovery.
- When a power failure is encountered during a printing cycle, the register prints "===== " and then carries out the correct printing procedure after power recovery. (See the sample print.)

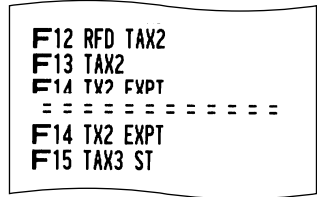

2 In Case of Printer Error

If the printer runs out of paper, the printer will stall, and "PAPER EMPTY" will appear on the display. Key entries will not be accepted. Refer to section 4 in this chapter, install a new roll, then press the (CL) key. The printer will print the power failure symbol and resume printing.

If the print head comes up, the printer stalls, "HEAD UP" will appear on the display. Key entries will not be accepted. Bring the print head back to the correct position, then press the (CL) key. The printer will print the power failure symbol and resume printing.

3 Cautions in Handling the Printer and Recording Paper

■ Cautions in handling the printer

- If you are not going to use the register for an extended period of time, pull the print head release lever toward you so that the print head is set apart from the plate. (head-up position)
- Avoid dusty and humid environments, direct sunlight and iron powder (a permanent magnet and electromagnet are used in this machine.)
- Use the print head release lever only when necessary.
- Never pull the paper when it is in contact with the print head. First release the head with the print head release lever, and then remove the paper.
- Never touch the surface of the print head.
- Never touch around the print head and the motor during printing or before they have had sufficient time to cool.

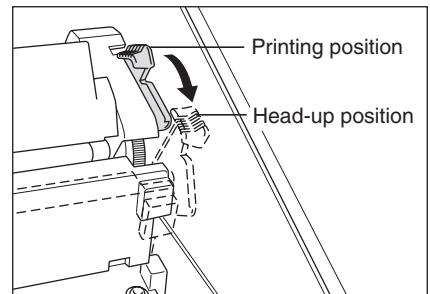

■ Cautions in handling the recording paper (thermal paper)

- Use only paper specified by SHARP.
- Do not unpack the thermal paper until you are ready to use it.
- Avoid heat. The paper will color at around 70°C.
- Avoid dusty and humid storage places. Avoid direct sunlight.
- The printed text on the paper can discolor under conditions of high humidity and temperature, exposure to direct sunlight, contact with glue, thinner or a freshly copied blueprint, and heat caused by friction from scratching or other means.
- Be very careful when handling the thermal paper. If you want to keep a permanent record, copy the printed text with a photocopier.

4 Replacing the Paper Roll

Be sure to use paper rolls specified by SHARP.

The use of any other paper rolls other than those specified could cause paper jamming, resulting in register malfunction.

Paper specification

Paper width: 1.75 ± 0.02 in (44.5 ± 0.5 mm)

Max. outside diameter: 3.18 in (81 mm)

Quality: Thermal paper

• **Be sure to set paper roll(s) prior to using your machine, otherwise it may cause a malfunction.**

Install the paper roll in the printer. Be careful to set the roll and cut the paper end correctly.

If the top end of the paper roll is fixed with paste or tape, the paper may lose its color development ability in the pasted or taped area due to the deterioration of the heat-sensitive color development component of the paper surface. This may result in nothing appearing at this location when printing. Therefore, when setting a new paper roll in the machine, be sure to cut off approximately one revolution (approx. 25 cm long).

(How to set the paper roll)

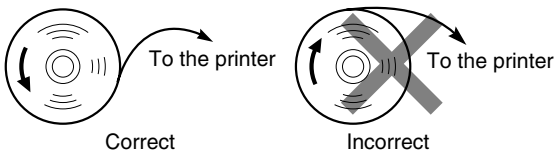

(How to cut the paper end)

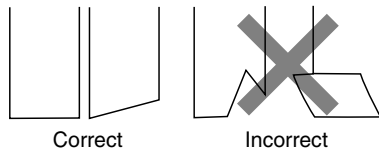



■ Removing the paper roll

When a red dye appears on the paper roll, it is time to replace it. Replace the paper roll with a new one. If you plan on not using the register for an extended period of time, remove the paper roll, and store it in an appropriate place.

Caution: The paper cutter is mounted on the printer (receipt side). Be careful not to cut yourself.

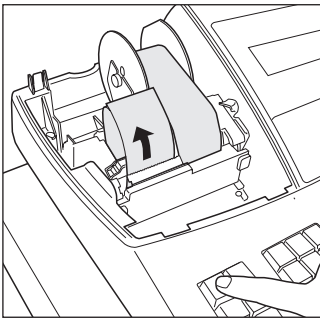
Removing the receipt paper roll:





1. Turn the mode switch to the REG position with the power cord connected.
2. Remove the printer cover.
3. Cut the paper behind the printer and near the paper roll.
4. Press the  key until the paper remaining in the printer comes out completely.
5. Remove the paper roll from the paper roll cradle of the receipt side.

Note Do not pull the paper through the printer.

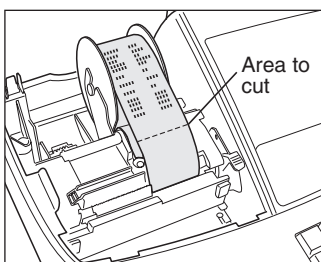
Removing the journal paper roll:



1. Turn the mode switch to the REG position with the power cord connected.
2. Remove the printer cover.
3. Press the  key to advance the journal paper until its printed part is out of the way.
4. Cut the paper and remove the take-up spool.
5. Cut the paper behind the printer and near the paper roll.
6. Press the  key until the paper remaining in the printer comes out completely.
7. Remove the paper roll from the paper roll cradle of the journal side.

Note Do not pull the paper through the printer.

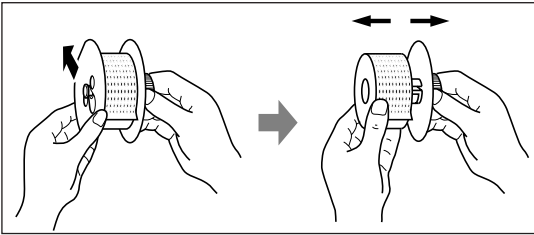



8. Remove the outer side of the take-up spool as shown on the left.
9. Remove the printed journal roll from the take-up spool.

■ Installing the paper roll

Caution: The paper cutter is mounted on the printer (receipt side). Be careful not to cut yourself.

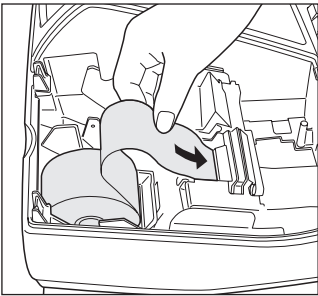

Installing the receipt paper roll:

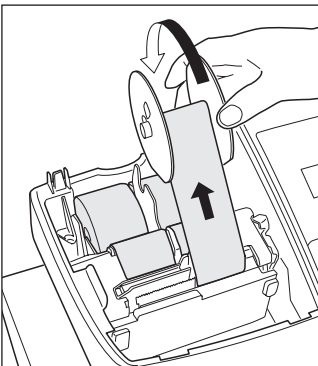

1. Turn the mode switch to the REG position with the power cord connected.
2. Remove the printer cover.
3. Check that the print head release lever is in the printing position.
4. Set the paper correctly in the paper roll cradle of the receipt side.
5. Insert the end of the paper into the paper chute of the printer until it is caught by the printer auto-feed and comes out of the top of the printer.
If the printer does not catch the paper, feed the paper while pressing the  key.
6. Cut off the excess paper using the paper cutter, and replace the printer cover.

Installing the journal paper roll:



1. Turn the mode switch to the REG position with the power cord connected.
2. Remove the printer cover.
3. Check that the print head release lever is in the printing position.
4. Set the paper correctly in the paper roll cradle of the journal side.
5. Insert the end of the paper into the paper chute of the printer until it is caught by the printer auto-feed and comes out of the top of the printer.
If the printer does not catch the paper, feed the paper while pressing the  key.
6. Insert the end of the paper into the slit in the paper spool. (Press the  key to feed more paper if required.)
7. Wind the paper two or three turns around the spool shaft.
8. Set the spool on the bearing, and press the  key to take up excess slack in the paper.
9. Replace the printer cover.

Note

When you want to manually install a new roll of paper while the machine is turned off, follow the steps shown below:

1. Pull the print head release lever toward you (to the head-up position). (Refer to the drawing on page 74.)
2. Correctly place the new paper roll into the paper roll cradle of the receipt/journal side.
3. Insert the paper end into the printer until it comes out of the printer.
4. Cut or roll the paper onto the take-up spool as described above.
5. Return the print head release lever to its original position.

5 Removing a Paper Jam

Caution: The paper cutter is mounted on the printer (receipt side). Be careful not to cut yourself. Never touch the print head immediately after printing, because the head may still be hot.

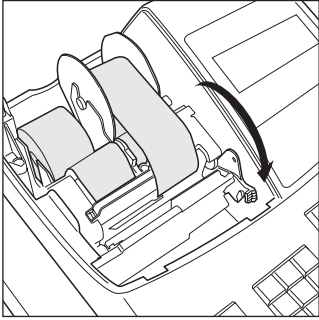

1. Remove the printer cover.
2. Pull the print head release lever all the way forward (after it stops at one position, continue pulling forward until it stops again and cannot be pulled forward any further).
3. Remove the paper jam. Check for and remove any shreds of paper that may remain in the printer.
4. Return the print head release lever to its original position.
5. Reset the paper roll correctly by following the steps in "Installing the paper roll".
6. Replace the printer cover.

6 Cleaning the Print Head

When the printed text is getting dark or faint, paper dust may be stuck to the print head. Clean the print head as follows:

Caution:

- Never touch the print head with a tool or anything hard as it may damage the head.
- The paper cutter is mounted on the printer (receipt side). Be careful not to cut yourself.

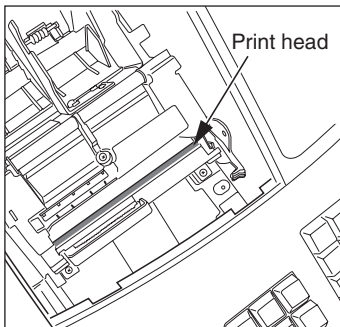

1. Turn the mode switch to the OFF position.
2. Remove the printer cover.
3. Pull the print head release lever all the way forward (after it stops at one position, continue pulling forward until it stops again and cannot be pulled forward any further).
4. Clean the print head with a cotton swab or soft rag moistened with ethyl alcohol or isopropyl alcohol.
5. Return the print head release lever to its original position immediately after cleaning.
6. Reset the paper roll correctly by following the steps in "Installing the paper roll".
7. Replace the printer cover.

7 Removing the Till and the Drawer

The till in the register is detachable. After closing your business for the day, remove the till from the drawer and keep the drawer open. To detach the drawer, pull it forward fully with the till removed, and remove it by lifting it up. The 6-denomination coin case is detachable.

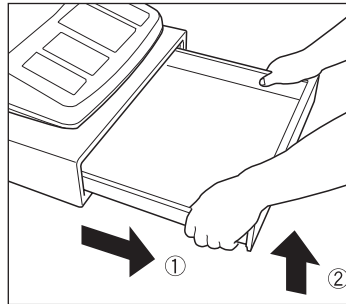
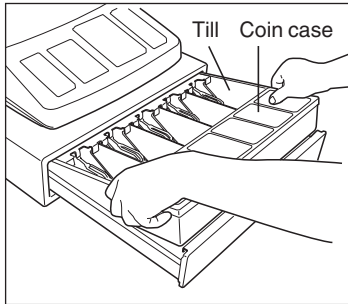

8 Opening the Drawer by Hand

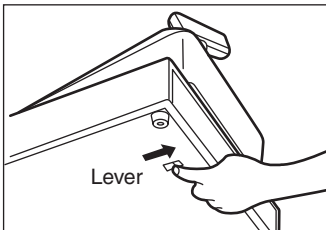

The drawer automatically opens. However, when a power failure occurs or the machine becomes inoperable, slide the lever located on the bottom of the machine in the direction of the arrow. (See the figure at the left.)

The drawer will not open if it is locked with the key.





9 Before Calling for Service

The malfunctions shown in the left-hand column below, labeled “Problem,” do not necessarily indicate functional faults of the machine. It is therefore advisable to refer to “Solution” shown in the right-hand column before calling for service.

Problem	Solution
(1) The display shows symbols that do not make sense.	<ul style="list-style-type: none"> • Has the machine been initialized properly as shown in “GETTING STARTED”? (Note that initialization clears all the data and programmed settings stored in memory.)
(2) The display won’t illuminate even when the mode switch is turned to any other position than “OFF”.	<ul style="list-style-type: none"> • Is power supplied to the electrical outlet? • Is the power cord plug out or loosely connected to the AC outlet?
(3) The display is illuminated, but the whole machine refuses registrations.	<ul style="list-style-type: none"> • Is a clerk code assigned to the register? • Is the mode switch set properly at the “REG” position?
(4) No receipt is issued.	<ul style="list-style-type: none"> • Is the paper roll properly installed? • Is there a paper jam? • Is the receipt function in the “OFF” status? • Is the print head release lever at the printing position?
(5) No journal paper is taken up.	<ul style="list-style-type: none"> • Is the take-up spool installed on the bearing properly? • Is there a paper jam?
(6) Printing is unusual.	<ul style="list-style-type: none"> • Is the print head release lever at the printing position? • Is the paper roll properly installed?

■ Error message table

When the following error messages are displayed, press the  key and take a proper action according to the table below.

Error message	Error status	Action
ENTRY ERROR	Registration error	Make a correct key entry.
MISOPERATION	Misoperation error	Make a correct key entry.
NO RECORD	Undefined code is entered.	Enter a correct code.
MEMORY FULL	Memory is full (in the  key programming).	Program the  key within 25 steps.
SBTL COMPUL.	Compulsory depression of the  key for direct finalization	Press the  key and continue the operation.
TEND COMPUL.	Compulsory tendering	Make a tendering operation.
NOT ASSIGNED	No entry of a clerk code	Make a clerk code entry.
OVER LIMIT.	Overflow limitation error	Make a registration within a limit of entry.
INH. OPEN PR	The open price entry is inhibited.	Make a preset price entry.
INH. UNIT PR	The preset price entry is inhibited.	Make an open price entry.
NOT NON-TEND	The direct finalization is inhibited.	Make a tendering operation.
BUFFER FULL	Subtotal void is not allowed.	Finalize the transaction, and correct the wrong entries in the void mode.
HEAD UP	Print head release lever is lifted up.	Move the lever toward the take-up spool (to the printing position).
PAPER EMPTY	Receipt and/or journal paper roll is not installed or empty.	Install a receipt and/or journal paper.

SPECIFICATIONS

Model:	XE-A42S																				
Dimensions:	16.5 (W) x 16.9 (D) x 11.9 (H) in. (420 (W) x 430 (D) x 302 (H) mm)																				
Weight:	27.5 lb (12.5 kg)																				
Power source:	120V AC \pm 10%, 60 Hz																				
Power consumption:	Stand-by 10 W Operating 44 W (max.)																				
Working temperature:	32 °F to 104 °F (0 °C to 40 °C)																				
Electronics:	LSI (CPU) etc.																				
Built-in battery:	Rechargeable batteries, memory holding time about 1 month (with fully charged built-in batteries, at room temperature)																				
Display:																					
Operator display:	Monochrome LCD with backlight (16 positions and 2 lines)																				
Customer display:	7-segment display (7 positions)																				
Printer:																					
Type:	2-station thermal printer																				
Printing speed:	Approx. 13.3 lines/second																				
Printing capacity:	24 digits each for receipt and journal paper																				
Other functions:	<ul style="list-style-type: none"> • Graphic logo printing function • Logo message function • Receipt (ON-OFF) function • Receipt and journal independent paper feed function 																				
Paper roll:	Width: 1.75 \pm 0.02 in (44.5 \pm 0.5 mm) Max. diam.: 3.18 in (81 mm) Quality: High quality (0.06 to 0.08 mm thickness)																				
Cash drawer:	5 slots for bill and 6 for coin denominations																				
Accessories:	<table border="0"> <tr><td>Manager key</td><td>1</td></tr> <tr><td>Operator key</td><td>1</td></tr> <tr><td>Drawer lock key</td><td>1</td></tr> <tr><td>Paper roll</td><td>2</td></tr> <tr><td>Take-up spool</td><td>1</td></tr> <tr><td>USB cable (0GS5422580//)*1</td><td>1</td></tr> <tr><td>Quick Start Guide (English)</td><td>1 copy</td></tr> <tr><td>Quick Start Guide (Spanish)</td><td>1 copy</td></tr> <tr><td>Instruction manual</td><td>1 copy</td></tr> </table>			Manager key	1	Operator key	1	Drawer lock key	1	Paper roll	2	Take-up spool	1	USB cable (0GS5422580//)*1	1	Quick Start Guide (English)	1 copy	Quick Start Guide (Spanish)	1 copy	Instruction manual	1 copy
Manager key	1																				
Operator key	1																				
Drawer lock key	1																				
Paper roll	2																				
Take-up spool	1																				
USB cable (0GS5422580//)*1	1																				
Quick Start Guide (English)	1 copy																				
Quick Start Guide (Spanish)	1 copy																				
Instruction manual	1 copy																				

Specifications and appearance subject to change without notice for improvement.

*1 Use only the USB cable supplied with the XE-A42S for the connection with a PC.

In case you need a new USB cable, order the USB cable manufactured by SHARP Co. Ltd. (Part code: 0GS5422580//) for use with the XE-A42S.

Use these labels with the department keys. Write department names on the labels and attach them to the department keys by first removing the transparent key covers. (Please make a copy of this page.)

Example:

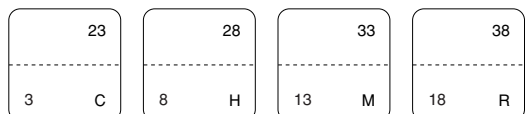
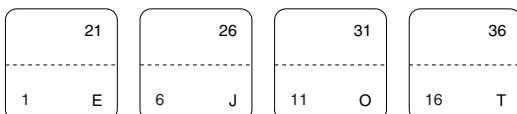
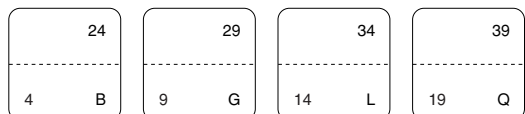
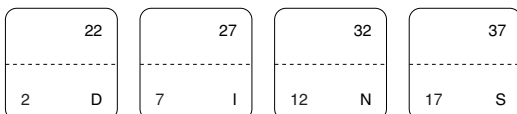
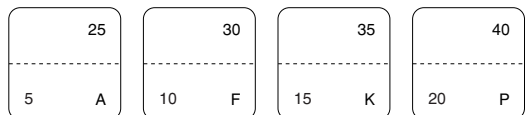

Programming sheet for departments (Please make copies of this sheet.)

Dept. code	Unit price	Function											Text
		BR	G	CM	T4	T3	T2	T1	SICS	SIGN	LMT	ENT	
		A	B	C	D	E	F	G	H	I	J	K	
Ex. 5	100	0	1	0	0	0	0	1	0	0	5	3	FRUIT

For details of programming, refer to pages 36, 37, and 47.

Unit price Max. 6 digits

Function

- A** BR (bottle return) Bottle return: 1, Normal: 0
- B** G (group number) 0 to 9 (0: non group)
- C** CM (commission group number) 0 to 2 (0: non commission)
- D-G** T4 - T1 (taxable 4 - taxable 1) Taxable: 1, Non-taxable: 0
- H** SICS (single item cash sale) SICS: 1, Normal: 0
- I** SIGN Negative dept.: 1, Positive dept.: 0
- J** LMT (entry digit limit) 0 to 7 digits
- K** ENT (entry method) Open and preset: 3, Preset only: 2, Open only: 1, Inhibit: 0
- Text** Max. 16 digits

INTRODUCCION

Le agradecemos la adquisición de la caja registradora electrónica SHARP modelo XE-A42S. Sírvase leer este manual detenidamente antes de hacer funcionar la caja registradora para familiarizarse y comprender por completo sus funciones y características. Guarde este manual para futura referencia dado que le servirá de ayuda en caso de tener algún problema de funcionamiento con la caja registradora.

¡PRECAUCION!

Asegúrese de inicializar la caja registradora antes de ponerla en funcionamiento. De lo contrario, se perturbará el contenido de la memoria y se producirá el mal funcionamiento de la caja registradora. Para ver los procedimientos, consulte la página 6.

IMPORTANTE

- **La impresora tiene instalado un cortador de papel. Tenga mucho cuidado de no cortarse con el cortador de papel.**
- **Instale la caja registradora en un lugar en el que no esté expuesta a radiaciones directas, cambios anormales de temperatura, alta humedad o en contacto con agua.**
Si la instala en estos lugares, podría originar daños en la caja y en los componentes electrónicos.
- **No opere nunca la caja registradora con las manos mojadas.**
El agua podría filtrarse al interior de la registradora y causar averías en sus componentes.
- **Cuando limpie la caja registradora, utilice un paño suave y seco. No use nunca líquidos volátiles como por ejemplo bencina y/o disolventes.**
La utilización de estos productos químicos hará que la caja pierda color o sufra daños.
- **La registradora debe enchufarse a cualquier tomacorriente normal de pared (120V CA ±10%).**
Otros aparatos eléctricos enchufados en el mismo circuito eléctrico pueden hacer que la registradora funcione mal.
- **Si la caja registradora no funciona como debiera, solicite el servicio llamando al 1-800-BE-SHARP. No intente reparar la caja registradora usted mismo.**
- **Para desconectar por completo la alimentación eléctrica, desenchufe la clavija del tomacorriente.**

PRECAUCION

Esta caja registradora electrónica tiene un circuito de protección de la memoria incorporado que funciona mediante baterías.

Como sabe, todas las baterías con el tiempo se desgastan aunque no se utilicen. Por lo tanto, para asegurarse una carga inicial adecuada en el circuito de protección y evitar cualquier pérdida de la memoria una vez instalada la máquina, se recomienda recargar cada caja durante un período de 24 a 48 horas antes de ser utilizada. Para cargar las baterías, la máquina debe estar enchufada y el selector de modo debe estar en una posición que no sea "OFF". Esta precaución relativa a la recarga evitará llamadas iniciales innecesarias al servicio técnico.

Línea directa de asistencia a los clientes 1-800-BE-SHARP

Para realizar la configuración con facilidad, vea el apartado "PARA EMPEZAR" (página 6).



INDICE

INTRODUCCION	1
IMPORTANTE	1
PRECAUCION	1
INDICE	2
PARTES Y SUS FUNCIONES	3
PARA EMPEZAR	6
FUNCION DE AYUDA	7
REGISTRO BASICO DE VENTAS	8
1 Ejemplo de registro básico de ventas	8
2 Aviso de error	9
3 Registros de artículos.....	9
Registros de un solo artículo	9
Registros repetidos.....	10
Registros de multiplicación	10
Registros de precios divididos	10
Registros de venta en metálico de un solo artículo (SICS)	11
Función de solicitud (verificación) de precios de PLU (codificación de precios)/ UPC (código de productos universales)	11
Función de aprendizaje de UPC	12
4 Visualización de los subtotales	12
5 Finalización de una transacción	12
6 Cálculo de los impuestos	13
Impuestos automáticos.....	13
Impuestos manuales	13
Borrado de los impuestos	13
Cambio del estado de impuestos	13
CARACTERISTICAS OPCIONALES	14
1 Registros auxiliares	14
2 Tratos de pagos auxiliares	15
3 Registros con tecla de secuencia automática (tecla AUTO)	16
CORRECCION	16
PROGRAMACION DE LAS FUNCIONES BASICAS (Para el inicio rápido)	17
1 Programación de la fecha y de la hora	17
2 Programación de los impuestos para la función de cálculo automático de los impuestos.....	17
PROGRAMACION DE FUNCIONES AUXILIARES	19
1 Programación de secciones	19
2 Programación de PLU/UPC	21
3 Programación de la tasa de comisión	22
4 Programación de teclas misceláneas	23
5 Programación de texto	25
PROGRAMACION AVANZADA	29
1 Programación de número de caja registradora y de número consecutivo	29
2 Programación 1 de selección de diversas funciones	30
3 Programación 2 de selección de diversas funciones	33
4 Lectura de programas almacenados.....	35
MODO DE INSTRUCCION	35
LECTURA (X) Y REPOSICION (Z) DE LOS TOTALES DE VENTAS	36
REGISTROS DE ANULACION	37
CORRECCION DESPUES DE FINALIZAR UNA TRANSACCION (Modo de cancelación)	37
COMO EMPLEAR UNA TARJETA DE MEMORIA SD	38
MANTENIMIENTO PARA EL OPERADOR	40
1 En caso de corte de la alimentación	40
2 En el caso de error de impresora	40
3 Precauciones al manejar la impresora	41
4 Reemplazo del rollo de papel.....	41
5 Extracción del papel atascado	42
6 Limpieza del cabezal de impresión	43
7 Extracción del separador de dinero y del cajón	43
8 Abertura manual del cajón	43
9 Antes de solicitar el servicio de un técnico.....	44

PARTES Y SUS FUNCIONES

1 Vista exterior

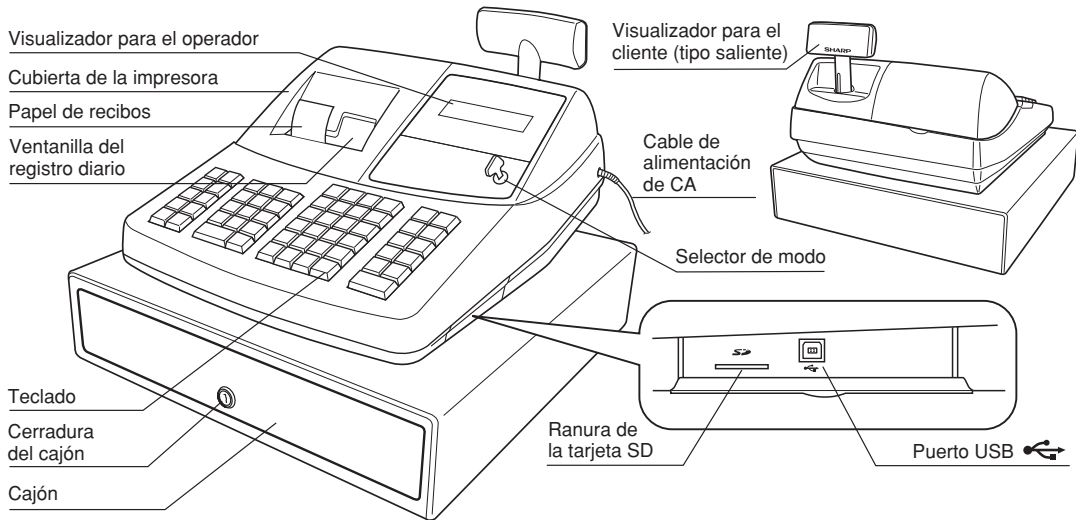

2 Impresora

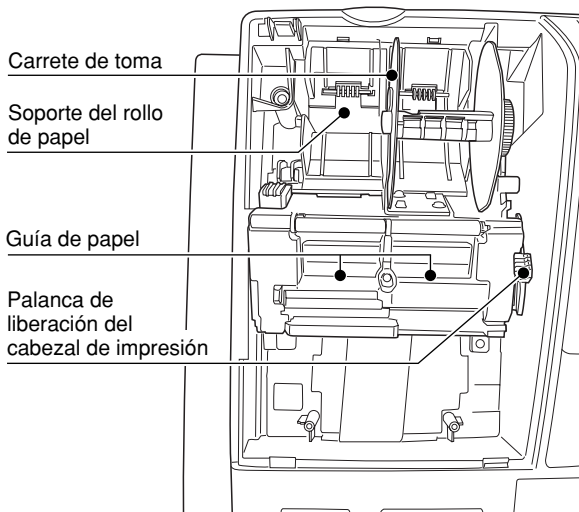

Levante la parte posterior de la cubierta de la impresora para extraerla. Para volver a instalar la cubierta de la impresora, engánchela en los trinquetes que hay en la caja y ciérrela.

Palanca de liberación del cabezal de impresión

El cabezal de impresión puede levantarse con la palanca verde del lado derecho de la impresora. Tirando de la palanca hacia delante, se levanta el cabezal de impresión. Si se atasca el papel y tiene que mover el cabezal más hacia delante, podrá tirar de la palanca aún más hacia usted y seguir con la extracción del papel atascado.

Nota No intente quitar el rollo de papel estando bajado el cabezal. Esto podría causar daños en la impresora y en su cabezal.

3 Selector de modo y llaves de modo

El selector de modo funciona insertando una de las dos llaves de modo suministradas: la llave del administrador (MA) y la del operador (OP). Estas llaves pueden insertarse o sacarse sólo cuando el selector esté en la posición "REG" u "OFF".

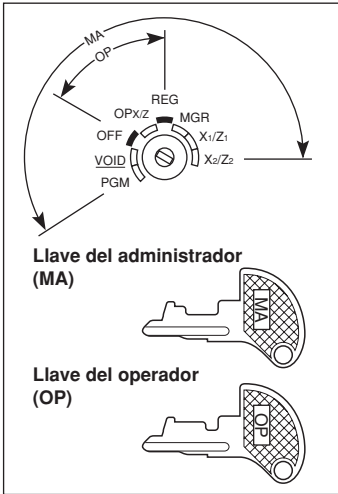

El selector de modo tiene estos ajustes:

- OFF:** Este modo bloquea todas las operaciones de la caja. (La alimentación de CA está desconectada.) No hay cambios en los datos registrados.
- OP X/Z:** Para sacar informes X o Z de dependiente individual, y para sacar informes rápidos. Puede usarse para alternar el estado "ON" u "OFF" de emisión de recibos pulsando la tecla **RCPT/PO**.
- REG:** Para registrar ventas.
- PGM:** Para programar diversos artículos.
- VOID:** Para establecer la caja registradora en el modo de cancelación. Este modo permite la corrección después de haber finalizado una transacción.
- MGR:** Para los registros del administrador. El administrador puede usar este modo para un registro de anulación.
- X1/Z1:** Para sacar el informe X/Z de varios totales diarios.
- X2/Z2:** Para sacar el informe X/Z de consolidación periódica (semanal o mensual).

4 Teclado

Disposición del teclado

RECEIPT ↑	JOURNAL ↑	@/FOR	•	CL	PLU /SUB	DEPT #	DEPT SHIFT	CLK# /CONV	INQ U	AUTO X
RA /AMT I	%1 /	7	8	9	25 5 A	30 10 F	35 15 K	40 20 P	TAX1 SHIFT V	TAX2 SHIFT Y
RCPT /PO -	%2 NUMBER	4	5	6	24 4 B	29 9 G	34 14 L	39 19 Q	TAX W	CH1 Z
VOID DC	RFND SHIFT	1	2	3	23 3 C	28 8 H	33 13 M	38 18 R	CHK	CH2
ESC /HELP BS	SPACE	0	00		22 2 D	27 7 I	32 12 N	37 17 S	MDSE SBTL	#/TM SBTL
					21 1 E	26 6 J	31 11 O	36 16 T	CA/AT/NS	

Nota

- En este manual, las teclas 0 ~ 9, 00, @/FOR, • y CL se representan con forma redonda en lugar de teclas cuadradas para distinguirlas de las otras teclas.
- Los caracteres pequeños de la parte inferior o de la esquina derecha inferior de cada tecla indican funciones o caracteres que pueden utilizarse para introducir caracteres para la programación de texto. Para más detalles, consulte la página 25.

Nombres de las teclas

RECEIPT	Tecla de suministro de papel de recibos	@/FOR	Tecla de multiplicación	INQ	Tecla de solicitud	
JOURNAL	Tecla de suministro de papel de registro diario	•	Tecla del punto decimal	TAX1 SHIFT	TAX2 SHIFT	Teclas de cambio de impuestos 1 y 2
RA /AMT	Tecla de recibido a cuenta/importe	CL	Tecla de borrado	AUTO		Tecla de secuencia automática
RCPT /PO	Tecla de impresión de recibos/pagos	00	0 ~ 9	TAX		Tecla de impuestos
VOID	Tecla de cancelación	PLU /SUB	Tecla de codificación de precios (PLU)/subsección	CHK		Tecla de cheque
ESC /HELP	Tecla de escape/ayuda	DEPT #	Tecla de registro de código de sección	CH1	CH2	Teclas de carga 1 y 2
%1	%2	DEPT SHIFT	Tecla de cambio de sección	MDSE SBTL		Tecla de subtotal de mercancías
RFND	Teclas de porcentaje 1 y 2	CLK# /CONV	Tecla de registro de código de dependiente/conversión	#/TM SBTL		Tecla de código de no suma/visualización de la hora/subtotal
SPACE	Tecla de descuento	21 1	20 20	CA/AT/NS		Tecla de total/importe recibido/no venta

5 Visualizaciones

■ Visualizador para el operador

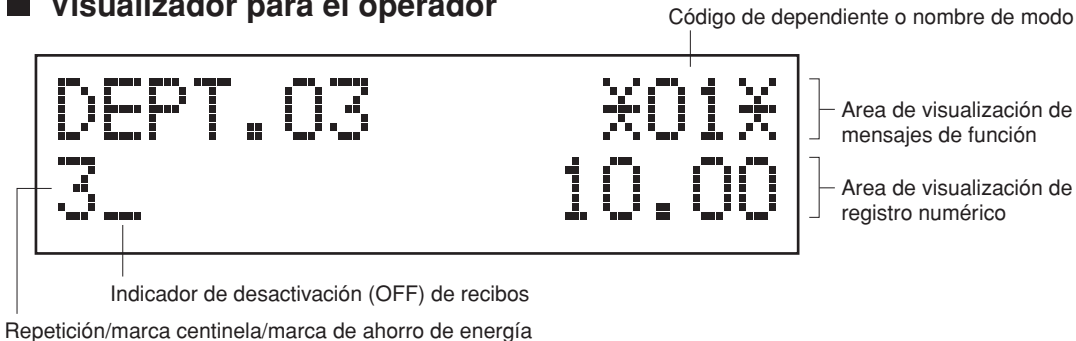

- **Código de dependiente o nombre de modo**

Se visualiza el modo en el que ahora se encuentre. Cuando se asigna un dependiente, se visualiza el código de dependiente en el modo REG u OP X/Z. Por ejemplo, se visualiza “*01*” cuando se asigna el dependiente 01.

- **Repetición**

Se visualiza el número de repeticiones, empezando por “2” y se incrementa con cada repetición. Cuando haya registrado diez veces, el visualizador mostrará “0”. (2 → 39 → 0 → 1 → 2...)

- **Marca centinela**

Cuando el importe en el cajón llega al importe que haya programado, la marca centinela “X” se visualiza para avisarle que ponga el dinero en un lugar seguro.

- **Marca de ahorro de energía**

Cuando la caja registradora se establece en el modo de ahorro de energía, se enciende la marca de ahorro de energía (punto decimal).

- **Area de visualización de mensajes de función**

Se visualizan las etiquetas de artículos de secciones y PLU/UPC y textos de función que usted usa, como por ejemplo, %1, (-), y CASH. Para los detalles de los textos de función, consulte la página 28. Cuando se debe introducir un importe, se visualiza ----- en el área de registro numérico con un mensaje de guía “ENTER PRICE”.

- **Area de visualización de registro numérico**

Aquí se visualizan los números que se introducen empleando las teclas numéricas.

Visualización de la fecha y de la hora

La fecha y la hora aparecen en el visualizador en el modo OP X/Z, REG, o MGR. En el modo REG o MGR, pulse la tecla para visualizar la fecha y la hora.

Luz posterior del visualizador LCD

Si ocurre un error o se pulsa la tecla o o se establece el modo de cancelación, la luz posterior verde se volverá roja.

Mensaje de error

Cuando ocurre un error, se visualiza el mensaje de error correspondiente en el área de visualización de mensajes de función. Para los detalles de los mensajes de error, consulte el apartado de “Tabla de mensajes de error” de la página 45.

■ Visualizador para el cliente (tipo saliente)



6 Llave de la cerradura del cajón

Esta llave bloquea y desbloquea el cajón. Para bloquear el cajón, gire la llave 90 grados hacia la izquierda. Para desbloquearlo, gírela 90 grados hacia la derecha.

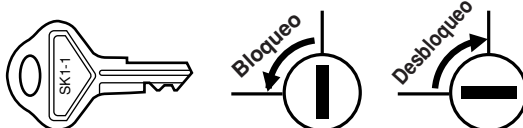



PARA EMPEZAR

Siga el procedimiento mostrado a continuación.

1. Inicialice la caja registradora.

Para que la caja registradora pueda funcionar correctamente, deberá inicializarla antes de ponerla en funcionamiento por primera vez. Siga el procedimiento siguiente.

1. Asegúrese de que la clavija del cable de alimentación **no** esté enchufada en la toma de corriente de CA.
2. Inserte la llave de administrador (MA) en el selector de modo y gírelo a la posición PGM.
3. Mientras mantiene pulsadas la tecla  y la tecla , enchufe la clavija en la toma de corriente de CA. El zumbador sonará tres veces y se visualizará “*** MRS. ***”.
4. La caja registradora habrá quedado ahora inicializada. El visualizador de la caja registradora mostrará “0.00” con “PGM”.

Precaución





La caja registradora tiene un circuito de protección de la memoria incorporado que funciona mediante baterías. Puesto que se han descargado las baterías, cargue las baterías durante uno o dos días antes de usar la caja registradora por primera vez. Para cargar las baterías, ponga el selector de modo en una posición que no sea “OFF” con el cable de alimentación enchufado en la toma de corriente de CA.

A menos que se hayan cargado las baterías, no se almacenan todos los datos programados y los datos de ventas.

2. Prepare la caja registradora.

1. Empuje la cubierta de la impresora hacia delante y sepárela.
2. Extraiga el retenedor blanco. Guarde este retenedor para cuando transporte la caja registradora en el futuro.
3. Mueva la palanca de liberación del cabezal de impresión hacia la posición de impresión.

3. Instale rollos de papel.

1. Corte aproximadamente una vuelta de cada rollo de papel. Asegúrese de que el extremo del papel se corte recto.
2. Ponga un rollo de papel en el soporte del rollo de papel del lado de recibos.
3. Inserte el extremo del papel en la guía de papel hasta que entre en el dispositivo de alimentación automática de la impresora y salga por la parte superior de la impresora. Si la impresora no engancha el papel, haga avanzar el papel mientras pulsa la tecla .
4. Corte el papel sobrante empleando el cortador de papel.
5. Ponga un rollo de papel en el soporte del rollo de papel del lado de registro diario.
6. Inserte el extremo del papel en la guía de papel de la impresora hasta que entre en el dispositivo de alimentación automática de la impresora y salga por la parte superior de la impresora. Si la impresora no engancha el papel, haga avanzar el papel mientras pulsa la tecla .
7. Inserte el extremo del papel en la ranura del carrete de toma y doble el papel hacia el lado frontal. (Pulse la tecla  para hacer avanzar más el papel si es necesario.)
8. Bobine el papel dos o tres vueltas en torno al eje del carrete.
9. Coloque el carrete en el rodamiento, y pulse la tecla  para sacar la flojedad excesiva del papel.
10. Vuelva a colocar la cubierta de la impresora.

4. Programe la fecha, la hora y los impuestos.

Nota

La caja registradora le ofrece los idiomas inglés, francés y español para el texto. El idioma preajustado es el inglés. Si desea cambiar el idioma, deberá cambiarlo antes de realizar la programación. Consulte el apartado de “Selección del idioma” para cambiar el idioma.

Antes de poder seguir con el registro de las ventas, **deberá programar:**

- la fecha
- la hora
- los impuestos

Consulte la sección de PROGRAMACION DE LAS FUNCIONES BASICAS para encontrar más detalles (página 17).

5. Programe otros elementos necesarios.

Aunque la caja registradora viene ya programada para utilizarla con la mínima configuración, la máquina le ofrece funciones opcionales. Antes de comenzar la programación, lea la sección de operaciones de ventas para entender las funciones opcionales.

FUNCION DE AYUDA

La función de ayuda le permite imprimir mensajes de guía para configuración y algunas operaciones de la caja registradora. Esta función está disponible en cualquier posición del selector de modo que no sea "OFF".

■ Impresión del menú de ayuda

Pulse la tecla **ESC/HELP** para imprimir el menú de ayuda. Este menú muestra la lista de operaciones, que pueden imprimir el mensaje de guía mediante la función de ayuda. La función de ayuda le permite imprimir mensajes de guía para la siguiente configuración y operaciones: Configuración de la fecha y hora / Configuración de la tasa de impuestos / Precio y texto de sección / Informe de ventas Z / Membrete / Emisión de recibo / Error "Dependiente no asignado" / Comando de tarjeta SD / Instalar software de PC

■ Impresión de mensajes de guía

Consultando el menú de ayuda impreso arriba, pulse la tecla numérica correspondiente y luego la tecla **ESC/HELP** para imprimir el mensaje de guía para cada operación.

Nota

*La tecla **ESC/HELP** sirve como la función de escape de error durante una transacción. Finalice la transacción para emplear la tecla como la función de ayuda.*

REGISTRO BASICO DE VENTAS

1 Ejemplo de registro básico de ventas

A continuación se muestra un ejemplo de registro básico de ventas en metálico de artículos. Para los detalles de la operación, consulte cada sección respectiva.

Ajuste del selector de modo

1. Gire el selector de modo a la posición REG.

Asignación de dependientes

2. Introduzca su código de dependiente. (Por ejemplo, si el código de dependiente es el 1. Pulse las teclas **1** y **CLK#/CONV** en este mismo orden.)

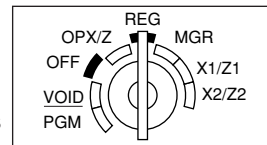

Registros de artículos

3. Introduzca el precio para el primer artículo de sección. (Por ejemplo, para 15,00, introduzca **1** **5** **00**, y pulse la tecla de la sección correspondiente.)

Para las secciones 21 a la 40, pulse primero la tecla **DEPTSHIFT** antes de pulsar la tecla de la sección.

Para la sección 41 y posteriores, introduzca el código de sección empleando las teclas numéricas, y pulse la tecla **DEPT#**, y luego introduzca el precio y pulse de nuevo la tecla **DEPT#**.

4. Repita el paso 3 para todos los artículos de sección.

Visualización de subtotales

5. Pulse la tecla **#TMSBTL** para visualizar el importe a cobrar.

Finalización de la transacción

6. Introduzca el importe recibido del cliente. (Podrá omitir este paso si el importe recibido es el mismo que el subtotal.)

7. Pulse la tecla **CA/AT/NS**, y se visualizará la vuelta (cuando no se ha introducido el importe recibido, se visualiza el importe total) y se abrirá el cajón.

8. Corte el recibo y dáselo al cliente con su vuelta.

9. Cierre el cajón.

Ejemplo de operación de teclas

Asignación de dependiente → 1 CLK#/CONV	CLERK01 *01* -01-
Registros de artículos {	1500 1 ²¹ DEPT.01 *01* 15.00
	2300 2 ²² DEPT.02 *01* 23.00
Visualización del subtotal → #TMSBTL	SUBTOTAL *01* 40.38
5000	*01* 5000
Finalización de la transacción → CA/AT/NS	CHANGE *01* 9.62

(El ajuste de programación para selección del idioma está cambiado al español y la tasa de impuestos está ajustada a 6,25%.)

Impresión en el recibo

YOUR RECEIPT THANK YOU		Membrete gráfico
01/26/2010 4:03PM 01		Fecha/hora/código de dependiente
123456#1091 DAVID		Número de caja registradora/ número consecutivo/nombre de dependiente
DEPT. 01 T1 \$15.00		Artículos
DEPT. 02 T1 \$23.00		Precio
MOSE ST \$38.00		Subtotal de mercancías
TAX1 \$2.38		Importe de impuestos
		Estado de impuestos (T1: imponible 1)
ITEMS 2Q		Cantidad total
***TOTAL \$40.38		Importe total
CASH \$50.00		Pago en metálico/importe recibido
CHANGE \$9.62		Vuelta

No se imprime cuando sólo se venden artículos no imponibles.

Función de activación/desactivación (ON/OFF) de recibo

Podrá inhabilitar la impresión de recibos en el modo REG. Pulse la tecla **RCPTIPO** en la posición OP X/Z. Esta tecla cambia el estado de impresión de recibos de ON a OFF.

Para emitir un recibo cuando la función de activación/desactivación (ON/OFF) de recibo está desactivada (OFF):

Si el cliente quiere el recibo después de haber finalizado la transacción con la función de activación/desactivación (ON/OFF) de recibo desactivada (OFF), pulse la tecla **RCPTIPO**. Su caja registradora también puede imprimir un recibo de copia cuando la función de activación/desactivación (ON/OFF) está en el estado "ON".

Modo de ahorro de energía

La caja registradora se establecerá en el modo de ahorro de energía cuando no se efectúe ningún registro basándose en el límite de tiempo ya programado (ajuste inicial de 30 minutos). Cuando la caja registradora se establezca en el modo de ahorro de energía, se apagará toda la visualización excepto el punto decimal de la posición de la izquierda de la línea inferior. La caja registradora volverá al modo de operación normal al pulsar alguna tecla o al cambiar un modo.

2 Aviso de error

En los siguientes ejemplos, la caja registradora se establece en estado de error haciendo sonar un aviso audible y visualizando el mensaje de error correspondiente. Anule el estado de error pulsando la tecla **CL** y tome las medidas oportunas.

Consulte la tabla de mensajes de error en la página 45.

- Registre un número de más de 32 dígitos (desborde del límite de registro): Cancele el registro y vuelva a introducir un número correcto.
- Un error en la operación de teclas: Borre el error y continúe la operación.
- Un registro más allá del límite de registro de importes programado: Vea si el importe registrado es correcto. Si es correcto, puede introducirse en el modo MGR. Llame al administrador.
- Un subtotal con impuestos incluido excede de ocho dígitos: Borre el subtotal pulsando la tecla **CL** y pulse la tecla **CA/AT/NS**, **CHK**, **CH1** o **CH2** para finalizar la transacción.

Función de escape de error

Para abandonar una transacción debido a un error o a un imprevisto, emplee la función de escape de error como se muestra a continuación:

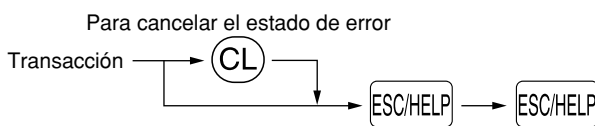

La transacción se cancela (se trata como un subtotal cancelado) y se emite el recibo mediante esta función. Si ya había introducido el importe entregado para el pago, la operación se finaliza como una venta en metálico.

3 Registros de artículos

Registros de un solo artículo

Registros de sección

- **Cuando se emplean las teclas de sección (para las secciones 1 a 40)**

Cuando utilice un precio unitario programado

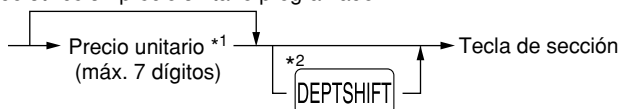

*1 Menos que los importes de límite superior programados
Cuando se introduce cero, sólo se añade la cantidad de ventas.

*2 Para las secciones 21 a 40, pulse la tecla de cambio de sección.

• Cuando se emplea la tecla de registro de código de sección

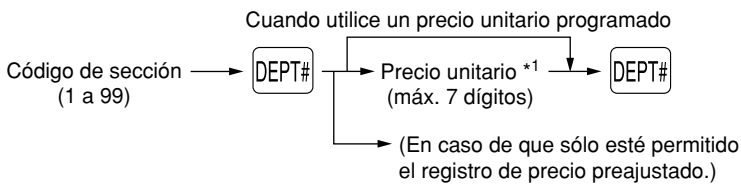

*1 Menos que los importes de límite superior programados
Cuando se introduce cero, sólo se añade la cantidad de ventas.

Registros de PLU/subsecciones

Cada PLU y subsección tiene un código de 1 a 7.000*, y debe pertenecer a una sección para obtener atributos de tal sección.

La caja registradora ya está programada para el modo PLU y cero para el precio unitario. Para emplear los registros de subsecciones, cambie al modo de subsección para los códigos de PLU.

* Se pueden programar un total de 7.000 códigos, incluyendo códigos de UPC.

• Registros de PLU

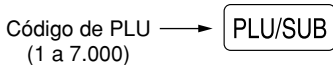

• Registros de subsección (PLU abierta)



*1 Menos que los importes de límite superior programados
Cuando se introduce cero, sólo se añade la cantidad de ventas.

• Registros de UPC (código de barras)



Nota

• La caja registradora se refiere a precios preajustados, no refiriéndose a la información del precio de los códigos de barras. Con el ajuste de fábrica, cuando un precio preajustado no ha sido programado, la caja registradora se establece en el estado de la función de aprendizaje de UPC para guiarle en la introducción de un precio unitario y demás información necesaria durante la operación de ventas. Para los detalles de la función de aprendizaje de UPC, consulte el apartado de "Función de aprendizaje de UPC" en la página 12.

■ Registros repetidos

Puede utilizar esta función para registrar una venta de dos o más artículos iguales. Repita la pulsación de una tecla de sección, tecla **DEPT#** o tecla **PLU/SUB**.

■ Registros de multiplicación

Cuando venda una gran cantidad de artículos, es conveniente emplear el método de registro de multiplicación. Introduzca la cantidad empleando las teclas numéricas y pulse la tecla **Ⓜ/PR** antes de comenzar el registro de artículos.

■ Registros de precios divididos

Esta función es práctica cuando un cliente desea comprar artículos que normalmente se venden en lotes. Para llevar a cabo esta función, deberá cambiar el ajuste programado. Consulte el apartado "Programación 1 de selección de diversas funciones" (código de tarea 70) para ver los detalles de la programación.

Para realizar los registros de precios divididos, siga el procedimiento siguiente:

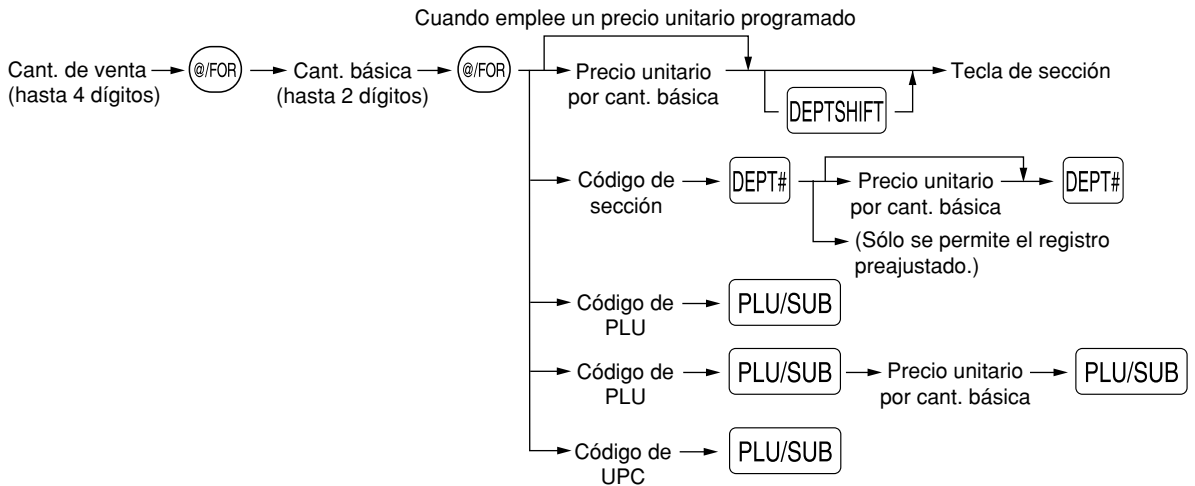

■ Registros de venta en metálico de un solo artículo (SICS)

- Esta función es útil cuando se vende solamente un artículo en metálico. Esta función es aplicable sólo a las secciones que se han ajustado para SICS o a sus PLU, subsecciones o UPC asociadas.
- Se completa la transacción y el cajón se abre tan pronto como pulse la tecla de sección, la tecla **DEPT#** o la tecla **PLU/SUB**.

■ Función de solicitud (verificación) de precios de PLU (codificación de precios)/UPC (código de productos universales)

Podrá emplear esta función cuando desee saber el precio unitario del artículo de PLU/UPC durante la transacción en el modo REG/MGR.

Para emplear la función de solicitud de precios, siga el procedimiento de abajo:

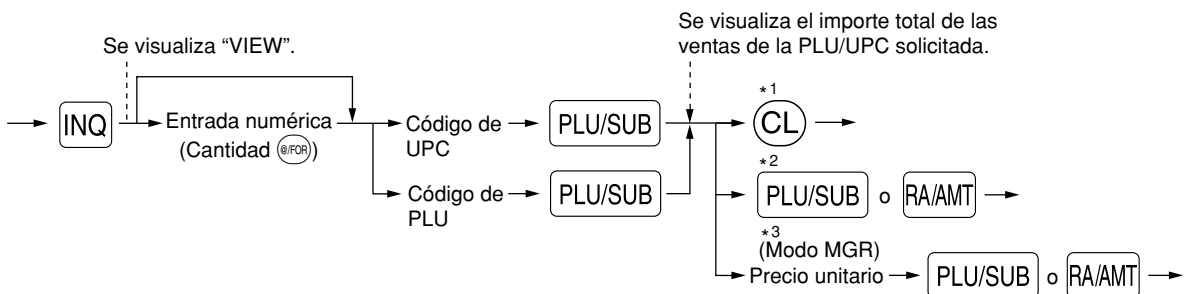

*1: Pulse la tecla **CL** para cancelar el modo de solicitud (verificación).

*2: Pulse la tecla **PLU/SUB** o **RA/AMT** cuando desee registrar el precio unitario de la PLU/UPC visualizado.

*3: Podrá cambiar el precio unitario provisionalmente en el modo MGR. No cambia el precio unitario programado en el modo PGM (Se considera como un registro de anulación de precio).

■ Función de aprendizaje de UPC

Cuando registra un código que no está programado, se le solicitará que registre su precio unitario y la sección asociada. El código de UPC, sección asociada y precio unitario registrados se almacenan en el archivo de UPC/EAN y se utilizarán para registros futuros de ventas de UPC.

Nota • Se aplica al código de UPC registrado el texto de su sección asociada.

Para emplear la función de aprendizaje de UPC, siga el procedimiento de abajo:

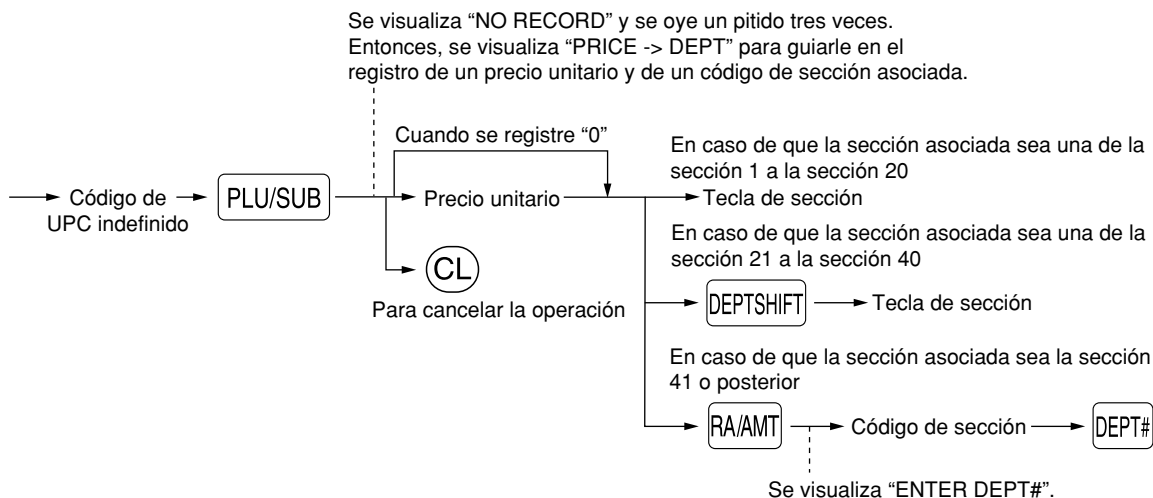

4 Visualización de los subtotales

La caja registradora ofrece tres tipos de subtotales:

Subtotal de mercancías

Pulse la tecla **[MDSESBTL]** en cualquier momento durante la transacción. Aparecerá el subtotal de venta neto, sin incluir los impuestos, en el visualizador con el mensaje de función "MDSE ST".

Subtotal imponible

Subtotal de imponible 1

Pulse las teclas **[TAX1SHIFT]** y **[#/TM/ SBTL]** en este orden en cualquier momento durante la transacción. Aparecerá el subtotal de venta de los artículos de imponible 1 en el visualizador con el mensaje de función "TAX1 ST".

Subtotal de imponible 2

Pulse las teclas **[TAX2SHIFT]** y **[#/TM/ SBTL]** en este orden en cualquier momento durante la transacción. Aparecerá el subtotal de venta de los artículos de imponible 2 en el visualizador con el mensaje de función "TAX2 ST".

Subtotal incluyendo los impuestos (subtotal completo)

Pulse la tecla **[#/TM/ SBTL]** en cualquier momento durante la transacción. Aparecerá el subtotal de venta con los impuestos incluidos en el visualizador con el mensaje de función "SUBTOTAL".

5 Finalización de una transacción

■ Importe recibido en metálico o cheque

Pulse la tecla **[#/TM/ SBTL]** para obtener un subtotal completo de impuestos, registre el importe entregado por el cliente, y entonces pulse la tecla **[CA/AT/INS]** si el importe es en metálico o pulse la tecla **[CHK]** si el importe es un cheque. Cuando el importe recibido es mayor que el importe de la venta, la caja registradora le mostrará el importe de la vuelta con el mensaje de función "CHANGE". De lo contrario, la caja registradora mostrará un déficit con el mensaje de función "DUE". Ahora deberá hacer el registro correcto del importe recibido.

■ Ventas en metálico o cheque que no necesitan un registro

Registre los artículos y pulse la tecla **CA/AT/NS** si se trata de una venta en metálico o pulse la tecla **CHK** si es una venta con cheque. La caja registradora visualizará el importe total de la venta.

■ Venta a cargo en cuenta (crédito)

Registre los artículos y pulse una tecla de cargo (**CH1** o **CH2**).

■ Ventas con importe recibido mixto

Podrá efectuar la mezcla de pagos con cheques y metálico, metálico y a cargo en cuenta, y cheque y a cargo en cuenta.

Por ejemplo: El cliente paga \$9,50 en metálico y \$40,00 a cargo a su cuenta 2 para un subtotal de \$49,50 con impuestos incluidos.

Ejemplo de operación de teclas

~ **#/TM/SBTL** 950 **CA/AT/NS** **CH2**

6 Cálculo de los impuestos

■ Impuestos automáticos

Cuando se ha programado una tasa de impuestos (o tabla de impuestos) en la caja registradora y el estado de impuestos para una sección individual está ajustado a imponible, la caja calcula los impuestos automáticos para cualquier artículo que se introduzca directamente en la sección o indirectamente mediante una PLU relacionada.

■ Impuestos manuales

La máquina le permite introducir manualmente los impuestos después de haber terminado el registro de artículos.

Ejemplo: Venta en metálico de un artículo de \$8,00 (sección 12) con 50 centavos como impuestos

Ejemplo de operación de teclas

800 **12³²** 50 **TAX** **CA/AT/NS**

■ Borrado de los impuestos

Podrá borrar los impuestos automáticos en el subtotal de imponible 1 y de imponible 2 de cada transacción pulsando la tecla **TAX** después de haberse visualizado el subtotal.

Para efectuar el borrado del subtotal de imponible 1, pulse **TAX1SHIFT**, **#/TM/SBTL** para obtener el subtotal de imponible 1, y entonces pulse **TAX** para borrar el subtotal.

Para efectuar el borrado del subtotal de imponible 2, pulse **TAX2SHIFT**, **#/TM/SBTL** para obtener el subtotal de imponible 2, y entonces pulse **TAX** para borrar el subtotal.

Para borrar todos los subtotales de imponibles (1-4), pulse **TAX1SHIFT**, **TAX2SHIFT** y **#/TM/SBTL** (se visualiza "TAX ST 0.00") y pulse **TAX** para borrar todos los subtotales de imponibles.

■ Cambio del estado de impuestos

La máquina le permitirá cambiar el estado de impuestos programado de cada tecla de sección o de PLU pulsando las teclas **TAX1SHIFT** y/o **TAX2SHIFT** antes de tales teclas. Después de completar cada registro, el estado de impuestos programado de cada tecla se repondrá al programado.

CARACTERÍSTICAS OPCIONALES

1 Registros auxiliares

■ Registros de descuento y recargo empleando la tecla de porcentaje

La tecla de porcentaje se emplea para aplicar un porcentaje de descuento o recargo manualmente introducido o preajustado a artículos individuales o a un subtotal de mercancías. Para el registro manual del porcentaje de descuento o de recargo, introduzca el porcentaje (hasta 100,00) con las teclas numéricas (necesitará un punto decimal cuando introduzca una tasa porcentual fraccionaria), y pulse la tecla de porcentaje. Cuando emplee un porcentaje preajustado (si se ha programado), pulse una tecla de porcentaje.

Cálculo porcentual para el subtotal de mercancías

Ejemplo de operación de teclas

~ MDSESBTL 10 %1 CA/AT/NS

Cálculo porcentual para registros de artículos

Ejemplo de operación de teclas

800 6²⁶ 7 • 5 %1 15 PLU/SUB %2 CA/AT/NS

(Cuando se programa un recargo del 15% para la tecla %2)

■ Registros de descuento y recargo empleando la tecla de descuento

La tecla de descuento se emplea para aplicar un importe de descuento o recargo manualmente introducido o preajustado a artículos individuales o a un subtotal de mercancías. Con el ajuste inicial, podrá introducir manualmente un importe de descuento a artículos individuales y a un subtotal de mercancías. Para el registro manual de los importes de descuento o de recargo, introduzca el importe con las teclas numéricas, y pulse la tecla de descuento. Cuando emplee un importe preajustado (si se ha programado), pulse la tecla de descuento.

Descuento para el subtotal de mercancías

Ejemplo de operación de teclas

~ MDSESBTL 100 ⊖ CA/AT/NS

Descuento para registros de artículos

Ejemplo de operación de teclas

675 7²⁷ ⊖ CA/AT/NS

(Cuando se programa el importe de descuento de \$0,75)

■ Registros de devolución

Para las secciones 1 a 20, registre el importe de devolución y pulse la tecla RFND, y entonces pulse la tecla de la sección correspondiente, y para las secciones 21 a 40, registre el importe de devolución y pulse la tecla RFND, y entonces pulse la tecla DEPTSHIFT y pulse la tecla de la sección correspondiente (cuando emplee el precio preajustado, omita el registro del importe). En el caso de las secciones 41 a 99, registre el código de sección y pulse la tecla RFND y la tecla DEPT#, y luego registre el importe de devolución y pulse la tecla DEPT# cuando sea necesario.

Para la devolución de un artículo de PLU/UPC, registre el código de PLU/UPC y pulse la tecla RFND, y entonces pulse la tecla PLU/SUB.

Para la devolución de un artículo de subsección, registre el código de PLU y pulse la tecla RFND y la tecla PLU/SUB, y entonces registre el importe de devolución y pulse la tecla PLU/SUB.

Nota

- Cuando inhabilita el ajuste de programa de la "codificación de precios PLU/UPC al registrar devoluciones" (tarea #16), tiene que realizar la operación siguiente para el registro de devoluciones de artículos de PLU y de artículos de UPC:
Para una devolución de un artículo de PLU/UPC, registre el código de PLU/UPC y pulse la tecla **RFND** y la tecla **PLU/SUB**, entonces registre el importe de devolución y pulse la tecla **PLU/SUB**.
- Para un registro repetido de devolución, pulse de nuevo la misma tecla que pulsó por última vez.

Registros e impresión de números de código de no suma

Podrá introducir un número de código de no suma, como pueda ser un número de código de cliente o número de tarjeta de crédito, con un máximo de 16 dígitos, en cualquier momento durante el registro de una venta. La caja registradora lo imprimirá.

Para introducir un número de código de no suma, introduzca el número y pulse la tecla **#TMSBTL**.

2 Tratos de pagos auxiliares

Conversión de divisas

La caja registradora permite registros de pago con divisas (sólo está disponible el pago en metálico). Pulsando la tecla **CLK#/CONV** se crea un subtotal en la divisa en cuestión.

Cuando emplee una tasa de conversión de divisas programada, pulse la tecla **CLK#/CONV** después de los registros de los artículos, e introduzca entonces el importe recibido en la divisa si no se trata de un pago con el importe justo, y pulse la tecla **CA/AT/NS**.

Cuando efectúe un registro manual de una tasa de conversión de divisas, después de los registros de todos los artículos, introduzca la tasa de conversión (0,0000 a 9999,9999; necesitará un punto decimal cuando introduzca una tasa de conversión fraccionaria), y pulse la tecla **CLK#/CONV**, y luego introduzca el importe recibido en la divisa en cuestión si no es un pago del importe justo, y pulse la tecla **CA/AT/NS**.

En ambos casos, la vuelta se visualizará en moneda nacional y, cuando el importe recibido sea insuficiente, el déficit se mostrará en moneda nacional.

Nota

- Pulse la tecla **CL** después de pulsar la tecla **CLK#/CONV** para cancelar el pago en una divisa.
- Si se programa, se imprime un símbolo de moneda extranjera.

Aplicación de la tasa de conversión preajustada

Ejemplo de operación de teclas

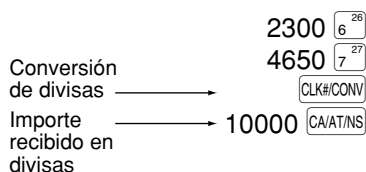

Registros de recibido a cuenta (RA) y de pagado (PO)

Cuando reciba un pago a cuenta o cuando usted paga a un abastecedor, emplee la tecla **RA/AMT** o la tecla **RCPTPO** respectivamente.

Para el registro de recibido a cuenta (RA), introduzca el importe y pulse la tecla **RA/AMT**.

Para el registro de pagado (PO), introduzca el importe y pulse la tecla **RCPTPO**.

■ Sin ventas (cambios)

Cuando deba abrir el cajón para algo que no sea una venta, pulse la tecla **CAI/AT/NS**. El cajón se abrirá y la caja registradora imprimirá "NO SALE" en el recibo o en el registro diario.

■ Devolución de botellas

Esta función se usa para manipular el depósito y pago (pagado) para botellas o latas vacías devueltas. Esta función es aplicable sólo a las secciones que hayan sido ajustadas para secciones de devolución de botellas o sus PLU, subsecciones o UPC asociadas.

3 Registros con tecla de secuencia automática (tecla **AUTO**)

Puede lograr una transacción programada pulsando la tecla **AUTO**.

CORRECCION

1 Corrección del último registro (cancelación directa)

Si hace un registro incorrecto relativo a una sección, PLU/subsección, UPC, porcentaje (**%1** y **%2**), descuento (**⊖**) o devolución, puede cancelar este registro pulsando la tecla **VOID** inmediatamente después del registro incorrecto.

Nota La luz posterior del visualizador se volverá roja cuando se pulse la tecla **VOID**.

2 Corrección del registro siguiente al último o anterior (cancelación indirecta)

Podrá cancelar cualquier registro de sección incorrecto, registro de PLU/subsección, registro de UPC o registro de devolución de artículo hechos durante una transacción, si lo encuentra antes de finalizar la transacción (por ejemplo, pulsando la tecla **CAI/AT/NS**). Esta función es aplicable sólo a los registros de sección, PLU/subsección, UPC y de devolución.

Pulse la tecla **VOID** justo antes de pulsar una tecla de sección, la tecla **DEPT#** (antes de la primera pulsación de la tecla **DEPT#** en caso de que se habiliten registros de apertura y de preajuste) o la tecla **PLU/SUB**. Para la cancelación indirecta de devolución, pulse la tecla **VOID** después de haber pulsado la tecla **RFND**.

3 Cancelación del subtotal

Puede cancelar una transacción completa. Una vez ejecutada la cancelación del subtotal, la transacción se detiene y la caja registradora emite un recibo. Esta función no funciona cuando se han introducido más de 50 artículos.

4 Corrección de registros incorrectos no hechos con la función de cancelación directa o indirecta

Cualquier error que encuentre después de haber terminado el registro de una transacción o durante el registro del importe recibido no podrá cancelarlo. Estos errores deben ser corregidos por el administrador.

Deben tomarse los pasos siguientes:

1. Si está haciendo usted el registro de importe recibido, finalice la transacción.
2. Haga los registros correctos desde el principio.
3. Entregue el recibo incorrecto al administrador para que lo cancele.

PROGRAMACION DE LAS FUNCIONES BASICAS (Para el inicio rápido)

Ponga la llave del administrador en el selector de modo y gírelo a la posición PGM.

1 Programación de la fecha y de la hora

Fecha

Para ajustar la fecha, introduzca la fecha con 8 dígitos empleando el formato de mes-día-año (MM/DD/AAAA), y pulse entonces la tecla **#/TM/SBTL**.

Ejemplo de operación de teclas

01262010 **#/TM/SBTL**
(26 de enero, 2010)

Hora

Para ajustar la hora, introduzca la hora con 4 dígitos empleando el formato de 24 horas. Por ejemplo, para ajustar la hora a las 2:30 AM, introduzca 230; y para ajustarla a las 2:30 PM, introduzca 1430.

Ejemplo de operación de teclas

1430 **#/TM/SBTL**

2 Programación de los impuestos para la función de cálculo automático de los impuestos

Antes de poder proceder al registro de ventas, primero deberá programar los impuestos que se cargan de acuerdo con las leyes de su estado. En esta caja registradora pueden programarse cuatro tasas de impuestos distintas. En la mayor parte de estados, sólo será necesario programar los impuestos 1. Sin embargo, si vive en una zona que tiene impuestos locales propios o impuestos de hospitalidad, podrá programar la caja registradora para que calcule estos impuestos por separado.

Cuando programe el estado de impuestos para una sección, los impuestos se añadirán automáticamente a los artículos de venta asignados a la sección de acuerdo con el estado de impuestos programado para la sección. También podrá introducir manualmente los impuestos.

Hay dos métodos para programar los impuestos. El método de la tasa de impuestos emplea una tasa porcentual directa por dólar. El método de tabla de impuestos requiere la información detallada de impuestos para las oficinas de impuestos estatales o locales. Emplee el método que sea aceptable para su estado. Podrá obtener los datos necesarios en la oficina de impuestos local para efectuar la programación de los impuestos.

Programación de los impuestos empleando una tasa de impuestos

La tasa porcentual aquí especificada se emplea para calcular los impuestos sobre subtotales imponibles.

Procedimiento

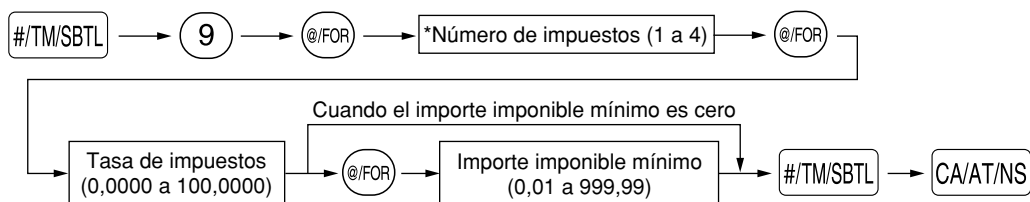

Para borrar una tasa de impuestos, emplee la secuencia siguiente:

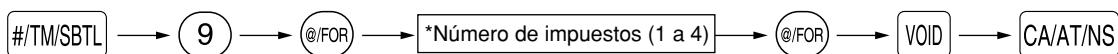

Ejemplo: Programación de la tasa de impuestos del 4% como tasa de impuestos 2 con exención de impuestos de 12¢

Ejemplo de operación de teclas



■ Tabla de impuestos (aplicable al impuesto añadido)

Si se encuentra en una localidad que emplea una tabla de impuestos para el cálculo de los impuestos, podrá programar consecuentemente la caja registradora. La programación de la tabla de impuestos puede efectuarse para impuestos 1 a impuestos 4.

Tabla de impuestos de muestra

Tabla de impuestos de New Jersey: 6%

Para programar una tabla de impuestos, primero haga una tabla como la tabla de la derecha mostrada a continuación.

Impuestos	Margen de importe de venta	
	Punto de división mínimo	Punto de división máximo
.00	.01	a .10
.01 — T	.11 — Q	a .22
.02	.23	a .38
.03	.39	a .56
.04	.57	a .72
.05	.73	a .88
.06	.89	a 1.10
.07	1.11 — M1	a 1.22
.08	1.23	a 1.38
.09	1.39	a 1.56
.10	1.57	a 1.72
.11	1.73	a 1.88
.12	1.89	a 2.10
.13	2.11 — M2	a 2.22



A: Diferencia entre el punto de división mínimo y el siguiente (¢)	
—	B: No cíclico
10 (0.11 - 0.01)	
12 (0.23 - 0.11)	C: Cíclico 1
16 (0.39 - 0.23)	
18 (0.57 - 0.39)	
16 (0.73 - 0.57)	
16 (0.89 - 0.73)	
22 (1.11 - 0.89)	D: Cíclico 2
12 (1.23 - 1.11)	
16 (1.39 - 1.23)	
18 (1.57 - 1.39)	
16 (1.73 - 1.57)	
16 (1.89 - 1.73)	
22 (2.11 - 1.89)	

Partiendo de la tabla de impuestos, calcule las diferencias entre el punto de división mínimo y el siguiente (A). Luego, partiendo de las diferencias, busque ciclos irregulares (B) y ciclos regulares (C y D). Estos ciclos le mostrarán los elementos necesarios para programar la tabla de impuestos:

- T:** El importe de impuestos recolectados en el importe imponible mínimo (Q)
- Q:** El importe imponible mínimo
- M1:** El valor máximo del punto de división mínimo en un ciclo regular (C)
A esto lo denominamos "punto MAX".
- M2:** El valor máximo del punto de división mínimo en un ciclo regular (D)
A esto lo denominamos "punto MAX".
- M:** Margen del punto de división mínimo en un ciclo regular: diferencia entre Q y M1 o entre M1 y M2.

Procedimiento

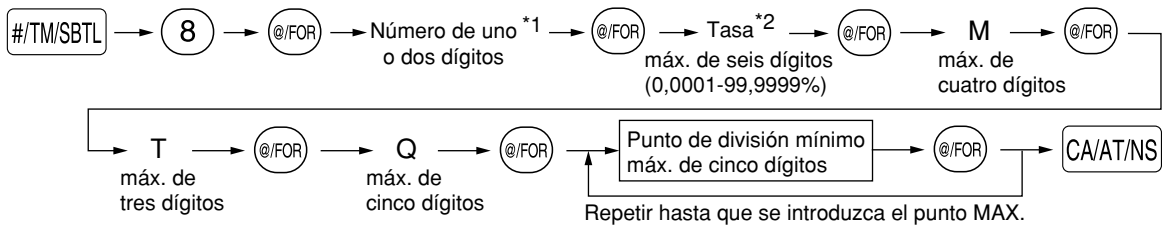

Para borrar una tabla de impuestos, emplee la secuencia siguiente:

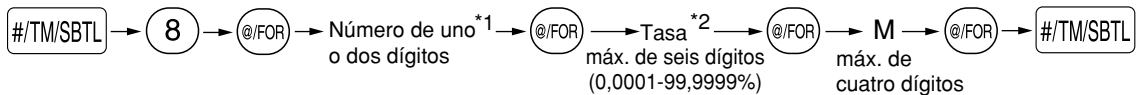

***1 Primer número:** (1 ó 0) Este primer número que se introduce depende de si la diferencia entre un punto de división mínimo a introducirse y el punto de división mínimo anterior no son de menos de \$1,00 ni de más de 99¢. Cuando la diferencia no sea de menos de \$1,00, introduzca "1", y cuando no sea de más de 99¢, introduzca "0" o no introduzca nada.

Segundo número: (1 a 4) El segundo número depende de si su tabla de impuestos debe programarse como tabla de impuestos 1, 2, 3, ó 4.

***2** Si la tasa es fraccionaria (por ejemplo 4-3/8%), la fracción (3/8) se convierte a su equivalente decimal (es decir, 0,375) y se introduce la tasa resultante de 4,375. Tenga presente que la tasa nominal (R) generalmente se indica en la tabla de impuestos.

Nota

Si hace un registro incorrecto antes de introducir la M al programar una tabla de impuestos, cáncélelo con la tecla CL ; y si comete un error después de haber introducido la M, cáncélelo con la tecla \#/TM/SBTL . Luego vuelva a hacer la programación desde el principio.

• Limitaciones para el registro de puntos de división mínimos

La caja registradora puede trabajar con una tabla de impuestos que conste hasta de 72 puntos de división como máximo. (El número máximo de puntos de división es de 36 cuando la diferencia de puntos de división es de \$1,00 o más.) Si el número de puntos de división excede la capacidad de tablas de la caja registradora, deberá emplear entonces el registro manual.

PROGRAMACION DE FUNCIONES AUXILIARES

1 Programación de secciones

La mercancía se puede clasificar en un máximo de 99 secciones.

■ Estado de sección

Procedimiento

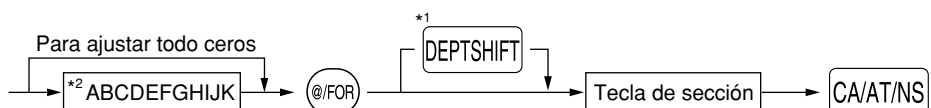

*1: Para programar las secciones 21 a 40, pulse la tecla de cambio de sección.

Para las secciones 41 a 99:

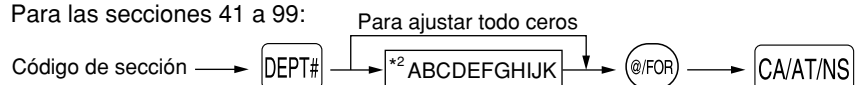

Para programar otra sección, comience desde el principio sin pulsar la tecla CA/AT/NS .

*2:Elemento:	Selección:	Registro:
A Tipo	Devolución de botellas	1
	Normal*	0
B Número de grupo		0-9 (0: Sin grupo) (ajuste inicial: 0)
C Número de grupo de comisión		0-2 (0: Sin comisión) (ajuste inicial: 0)
D Estado de impuestos 4	Imponible	1
	No imponible*	0
E Estado de impuestos 3	Imponible	1
	No imponible*	0
F Estado de impuestos 2	Imponible	1
	No imponible*	0
G Estado de impuestos 1	Imponible (*para la sección 1 a la sección 10)	1
	No imponible (*para la sección 11 a la sección 99)	0
H SICS / Normal	SICS	1
	Normal*	0
I Signo	Sección negativa	1
	Sección positiva*	0
J Límite de dígitos de entrada		0-7 (ajuste inicial: 7)
K Tipo de registros de precio unitario	Abertura y preajuste	3
	Sólo preajuste	2
	Sólo abertura*	1
	Tecla de sección invalidada	0

Tipo

- Seleccione una sección como sección normal o para la devolución de botellas.

Número de grupo

- Si se realiza un ajuste de grupo (0 a 9, 0: sin grupo), los artículos vendidos empleando las teclas de sección y las PLU y UPC asociadas se pueden clasificar en grupos para los informes de ventas.

Número de grupo de comisión

- Puede asignar un grupo de comisión (0 a 2, 0: sin comisión) a cada sección para la comisión de los dependientes. Cada importe de comisión para cada dependiente se calcula basándose en una tasa de comisión programada y luego se imprime en los informes de dependiente.

Estado de impuestos (imponible 1 a 4 / no imponible)

- Cuando se efectúa un registro de una sección imponible en una transacción, los impuestos se calculan automáticamente de acuerdo con la tabla o tasa de impuestos asociada.

SICS (Venta en metálico de un solo artículo)

- Si se efectúa primero un registro de una sección programada para SICS, la venta se finalizará como venta de pago en metálico así que se pulse la tecla de la sección. Si realiza el registro después de introducir una sección no programada para SICS, no se finalizará la venta hasta que se pulse la tecla **CA/AT/NS**.

Límite de dígitos de entrada

- Ajuste el número de dígitos permisibles para importes máximos de entrada para cada sección. El límite es eficaz para operaciones en el modo REG y puede pasarse por alto en el modo MGR.

■ Precio unitario preajustado

Procedimiento

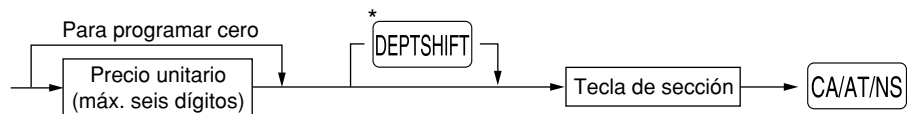

*Para programar las secciones 21 a 40, pulse la tecla de cambio de sección.

Para las secciones 41 a 99:

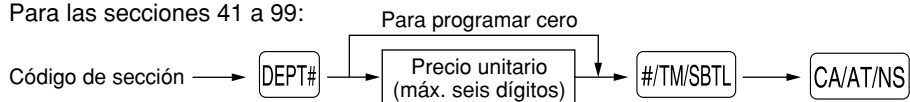

2 Programación de PLU/UPC

La caja registradora puede manipular códigos de PLU y de UPC.

Los códigos de PLU (codificación de precios) se emplean para las funciones de PLU y subsecciones:

La función de PLU permite realizar el registro rápido con las teclas en el que el precio se busca automáticamente al introducir un código.

La subsección es un tipo de "PLU abierta", que requiere que usted introduzca un precio detrás del código de PLU. Los códigos de PLU constan de un número de 4 dígitos y se pueden aplicar ceros delante de los códigos de PLU.

La caja registradora le permite introducir códigos de barras de UPC-A (caracteres del sistema numérico: 0, 2, 3, 4, 5), UPC-E, EAN-8 y EAN-13, empleando el teclado. La caja registradora también le permite introducir códigos AddOn (2 dígitos ó 5 dígitos) sumados a códigos de EAN-13 a excepción de códigos de ISBN e ISSN, empleando el teclado.

Se deben preajustar los precios unitarios para códigos de UPC, es decir, aunque se incluya la información del precio en un código, la caja registradora no se refiere a él para registro de la venta.

Pueden realizarse un máximo de 7.000 ajustes de códigos de PLU o UPC. Cada uno pertenece a una sección y adquiere los parámetros de la sección (tipo de sección (normal o devolución de botellas), grupo de secciones, estado de impuestos, SICS y signo). Se puede asignar un grupo de comisión (0 a 2, 0: No se aplica ninguna comisión) a cada sección para la comisión de los dependientes. Se calcula cada importe de comisión para dependiente individual en base a la tasa de comisión programada correspondiente y se imprime después en los informes de dependiente.

La caja registradora ya está programada de modo que PLU1 a PLU1200 ya están asignadas a las PLU (grupo de comisión: 0) asociadas con la sección 1 y el precio unitario preajustado "0".

■ Asignación de precios unitarios y de secciones asociadas

Procedimiento

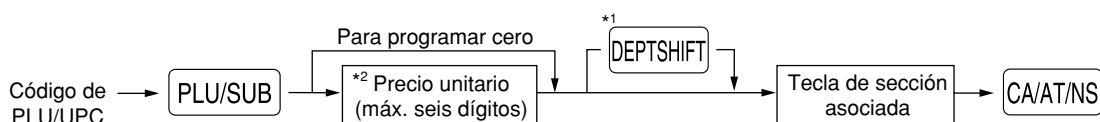

*1: Para asignar las secciones 21 a 40, pulse la tecla de cambio de sección.

Cuando la sección asociada es una de las secciones 41 a 99:

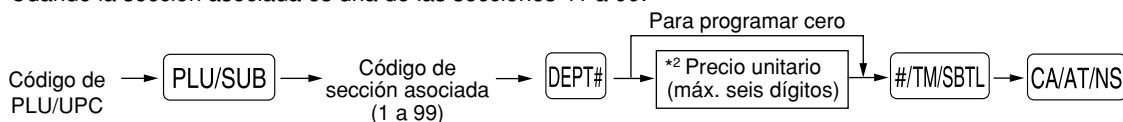

*2: Para una subsección, ajuste el importe límite de registro de precio unitario.

Para programar la siguiente PLU/UPC, empiece por introducir un precio unitario o un código de sección asociada sin pulsar la tecla **CA/AT/NS**.

Para programar otra PLU/UPC, empiece por el principio sin pulsar la tecla **CA/AT/NS**.

Para borrar un código de PLU/UPC, emplee la secuencia siguiente:

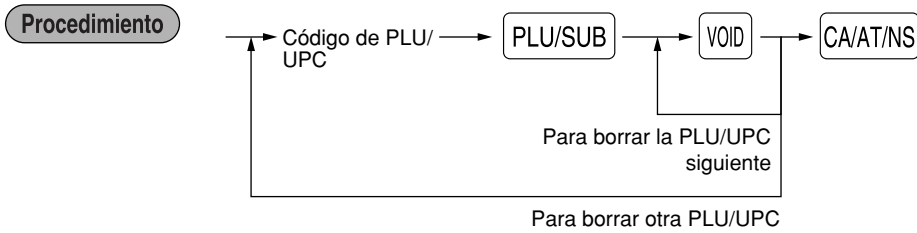

■ Selección de función

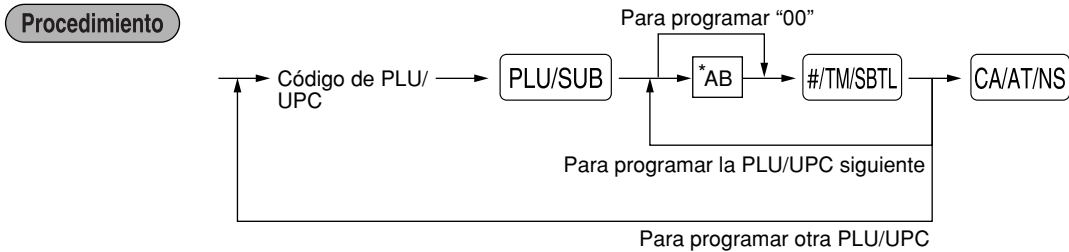

*: Elemento:	Selección:	Registro:
A Número de grupo de comisión		0-2 (0: Sin comisión) (ajuste inicial: 0)
B Selección de PLU/subsección (Sólo para el código de PLU)	Subsección PLU*	0 1

Cuando se programen los códigos de UPC, introduzca siempre 1 para B.

3 Programación de la tasa de comisión

Basándose en el total de ventas de cada dependiente de cada grupo de comisión y en la tasa de comisión correspondiente, se calculan los importes de comisión que se imprimen en los informes de dependiente.

■ Tasa de comisión

Procedimiento

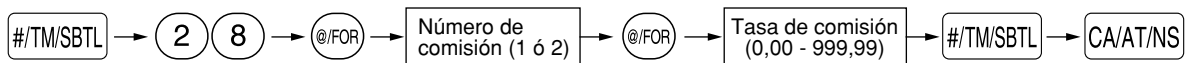

Deberá emplear un punto decimal para ajustar una tasa fraccionaria.

4 Programación de teclas misceláneas

■ Tasa para %1, %2 y CLK#/CONV (cuando se usa como tecla conv)

Procedimiento

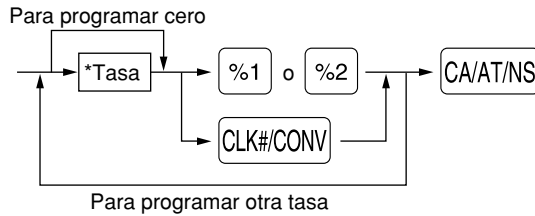

*: Tasa

0,00 – 100,00 (Tasa de porcentaje)

0,0000 – 9999,9999 (Tasa de conversión de divisas)

Deberá emplear un punto decimal para ajustar tasas fraccionarias.

■ Importe para ⊖

Procedimiento

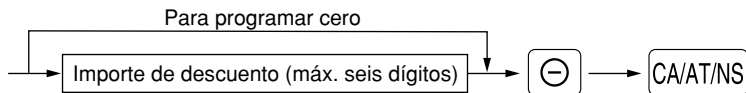

■ Límite de tasa porcentual para %1 y %2

Procedimiento

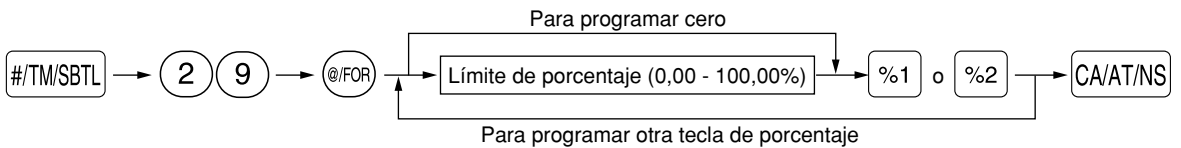

Nota

- Los registros porcentuales que exceden al límite superior pueden suprimirse en el modo MGR.
- 10,00% puede registrarse como 1 0 o 1 0 • 0 0. La tecla • es necesaria sólo para los registros fraccionarios.

■ Parámetros de función para %1, %2 y ⊖

Procedimiento

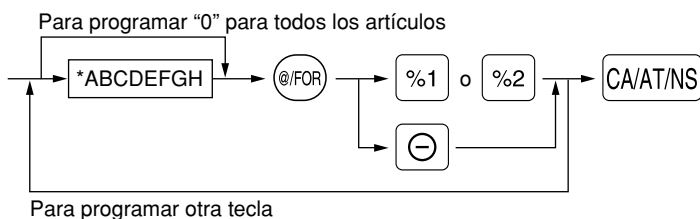

*: Elemento:	Selección:	Registro:
A Estado de impuestos 4	Imponible	1
	No imponible*	0
B Estado de impuestos 3	Imponible	1
	No imponible*	0
C Estado de impuestos 2	Imponible	1
	No imponible*	0
D Estado de impuestos 1	Imponible	1
	No imponible*	0
E Signo +/-	Signo + (recargo)	0
	Signo - (descuento)*	1
F % de artículo/⊖ de artículo	Habilitar*	0
	Inhabilitar	1
G % de subtotal/⊖ de subtotal	Habilitar*	0
	Inhabilitar	1
H Límite de dígitos de entrada para la tecla de descuento		0-7 (ajuste inicial: 7)

Cuando se programen las teclas de porcentaje, introduzca siempre 0 para H.

Estado de impuestos (imponible 1 a 4 / no imponible)

- Cuando se selecciona imponible, se aplican impuestos al importe obtenido después del cálculo de recargo o descuento.

Límite de dígitos de entrada (Sólo para la tecla de descuento)

- El límite de dígitos de entrada es de hecho para operaciones en el modo REG, pero puede suprimirse en el modo MGR.

■ Parámetros de función para CLK#/CONV

Procedimiento

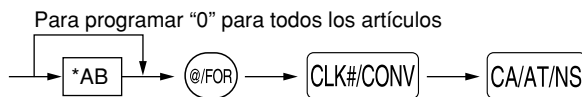

*: Elemento:	Selección:	Registro:
A Registro de tasa abierta	Habilitar*	0
	Inhabilitar	1
B Registro de tasa preajustada	Habilitar*	0
	Inhabilitar	1

■ Límite de dígitos de entrada para RA/AMT (cuando se usa como tecla RA), RCPT/PO (cuando se usa como tecla PO) y TAX

Procedimiento

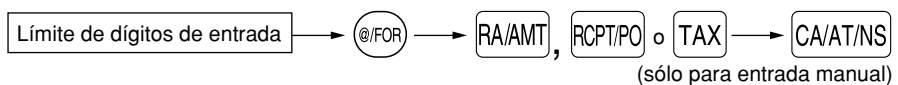

- Para RA/AMT RCPT/PO, introduzca 0 a 9 (dígitos), y para TAX (impuestos manuales), introduzca 0 a 7 (dígitos). El límite de dígitos de entrada es de hecho para operaciones en el modo REG, pero puede suprimirse en el modo MGR.

■ Parámetros de función para CHK, CH1, CH2 y CA/AT/NS (cuando se usa como tecla CA)

Procedimiento

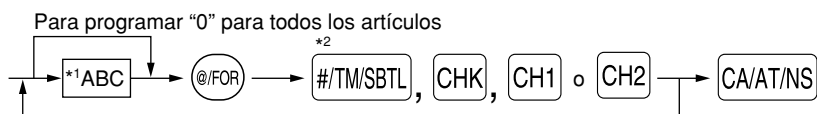

*2:Pulse la tecla #TMSBTL para ajustar la tecla CA.

*1: Elemento:	Selección:	Registro:
A Impresión de pie del recibo	Habilitar	1
	Inhabilitar*	0
B Registro de importe recibido	Obligatorio	1
	No obligatorio (para las teclas CA o CHK)*	0
	Invaldar (para la tecla CH1 o CH2)*	0
C Límite de dígitos de entrada		0-8 (ajuste inicial: 8)

Impresión de pie del recibo

- Esta programación decide si la registradora debe imprimir un mensaje en la parte inferior del recibo cuando se usa una de estas teclas de finalización especificada. Con respecto al método de programación del mensaje del membrete del pie de recibo, consulte la sección “Mensajes de membrete” en la página 29.

Límite de dígitos de entrada

- Para las teclas **CH1**, **CH2** y **CHK**, programe un importe de entrada de límite superior para el importe recibido. Para la tecla **CA/AT/NS**, programe un importe de entrada de límite superior para el importe total en metálico que puede manipularse en la caja registradora.

5 Programación de texto

La caja registradora le permite programar un texto para los nombres de dependiente, nombres de artículos de sección y nombres de artículos de PLU/UPC, cuando sea necesario. Hay dos formas de programar el texto: empleando las teclas de caracteres del teclado o introduciendo los códigos de los caracteres con las teclas numéricas del teclado.

Empleo de las teclas de caracteres del teclado

Podrá introducir caracteres de acuerdo con los caracteres pequeños que hay en la esquina inferior derecha de las teclas. Para ver la disposición, consulte la sección “Teclado” de la página 4.

Las teclas siguientes se emplean como teclas de control para la entrada de caracteres:

- SHIFT** Cambia entre letras mayúsculas y minúsculas. El ajuste inicial es el de letras mayúsculas seleccionadas. Una vez se ha pulsado la tecla **SHIFT**, se fija la entrada para letras minúsculas. “a” se visualiza cuando se selecciona la entrada de letras minúsculas como se muestra en el ejemplo del visualizador para el operador de abajo.
- NUMBER** Pulse la tecla **NUMBER** para introducir caracteres numéricos. Por ejemplo para introducir “1”, pulse la tecla **NUMBER** y la tecla **1**. Si pulsa la tecla **1** sin pulsar la tecla **NUMBER**, la caja registradora se establece en el modo de entrada de códigos de caracteres. Una vez se ha pulsado la tecla **NUMBER**, se fija la entrada para caracteres numéricos. “1” se visualiza cuando se selecciona la entrada de caracteres numéricos como se muestra en el ejemplo del visualizador para el operador de abajo.
- DC** Cambia entre caracteres de tamaño normal y de tamaño doble. En el ajuste inicial se han seleccionado los caracteres de tamaño normal. Una vez se pulsa la tecla **DC**, se fija la entrada para caracteres de tamaño doble. “W” se visualiza cuando se selecciona la entrada de caracteres de tamaño doble como se muestra en el ejemplo del visualizador para el operador de abajo.
- BS** Hace retroceder el cursor, borrando el carácter de la izquierda.

Visualizador para el operador (Ejemplo)

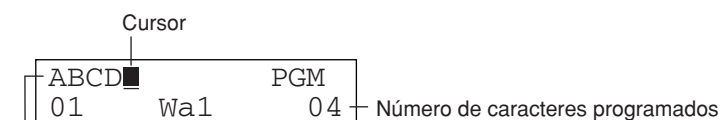

Aquí, se visualiza código de sección, código de PLU, código de UPC, número de función, código de dependiente o número de línea de mensajes de membrete. (El código de UPC desaparecerá cuando se pulse **SHIFT**, **NUMBER** o **DC**.)

Aquí, se visualizan los caracteres introducidos empleando las teclas de caracteres.

Ejemplo

Para programar la palabra "Clerk01" con la letra "C" de tamaño doble.

Para que la letra "C" sea de tamaño doble

DC C

=C■	PGM
01 W	02

Para que el tamaño de los caracteres vuelva al normal

DC

=C■	PGM
01	02

Para cambiar a letras minúsculas

SHIFT

=C■	PGM
01 a	02

L E R K

=Clerk■	PGM
01 a	06

Para introducir números

NUMBER 0 1

=Clerk01■	PGM
01 a1	08

Introducción de códigos de caracteres con las teclas numéricas del teclado

Los números, las letras y los símbolos pueden programarse introduciendo el código de carácter y la tecla (00). (Si se selecciona la entrada de caracteres numéricos, "1" se visualiza en el visualizador para el operador (línea inferior). Pulse la tecla [NUMBER] para que se apague.) Ajuste la tabla de códigos de caracteres alfanuméricos de la página 46 de la versión inglesa. Si lo hace así, podrá programar caracteres distintos de los que hay en las teclas.

- Pueden obtenerse caracteres de tamaño doble introduciendo el código de caracteres 253 o pulsando la tecla [DC]. "W" se visualiza cuando se selecciona la entrada de caracteres de tamaño doble como se muestra en el ejemplo del visualizador para el operador de abajo.
- DEBEN introducirse los tres dígitos del código del carácter (aunque empiece con cero).

Visualizador para el operador (Ejemplo)

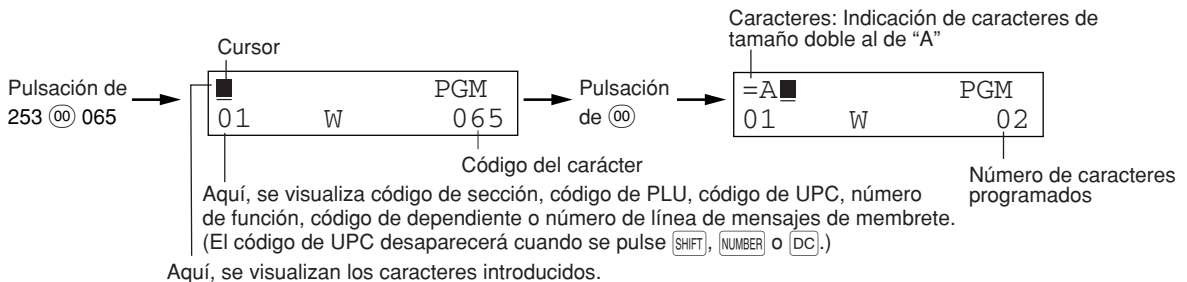

Ejemplo

Para programar la palabra "SHARP" en caracteres de tamaño doble.

253 (00) 083 (00) 072 (00) 065 (00) 082 (00) 080 (00)

S H A R P

Cuando pulsa una tecla del número apropiado (número de código de tarea) y pulsa la tecla (0) para entrada de texto justo después de haber comenzado la programación con la tecla [#TM/SBTL], la caja registradora quedará automáticamente preparada para la entrada siguiente.

■ Texto de sección (etiqueta de artículo)

Procedimiento

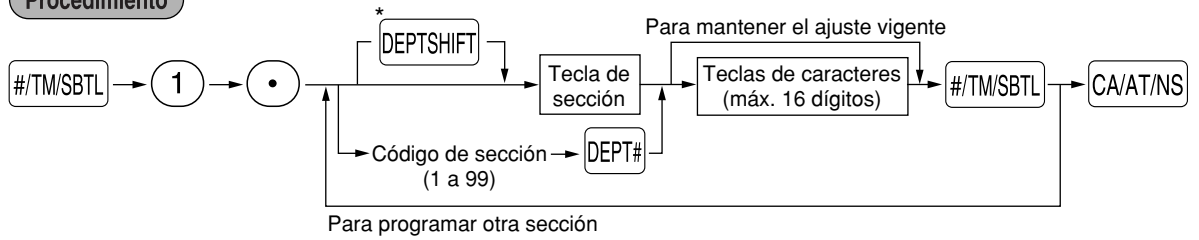

*Para programar las secciones 21 a 40, pulse la tecla de cambio de sección.

Ejemplo de operación de teclas

#/TM/SBTL 1 ● 1²¹ FRUIT #/TM/SBTL CA/AT/NS

(Programación de FRUIT para la sección 1)

■ Texto de PLU/UPC (etiqueta de artículo)

Procedimiento

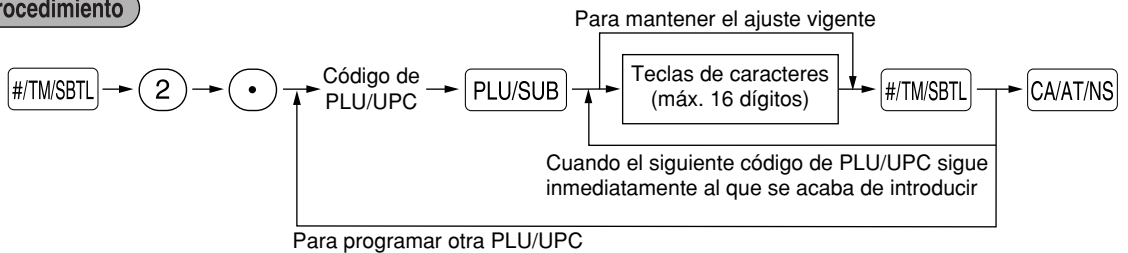

■ Texto de función

Procedimiento

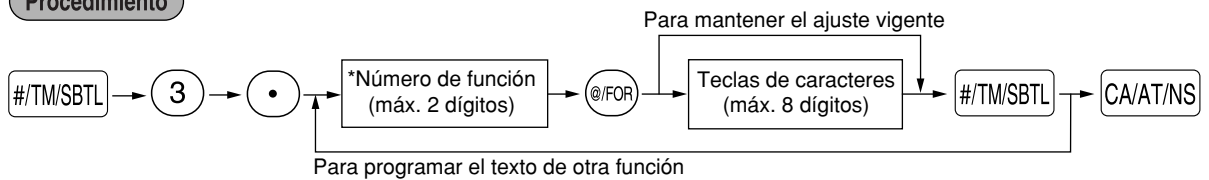

* Número de función: Vea la "Lista de textos de función" mostrada de la página siguiente.

■ Lista de textos de función

Número de función	Tecla o función	Ajuste inicial	Número de función	Tecla o función	Ajuste inicial
1	⊖	(-)	45	Cargo bruto 2	CHARGE2
2	%1	%1	46	Cargo de devolución 2	CHARGE2-
3	%2	%2	47	Conversión de divisas 1 (preajustada)	CONV 1
4	Total neto de ventas	NET1	48	Conversión de divisas 2 (abierta)	CONV 2
5	Subtotal neto de imponible 1	TAX1 ST	49	Metálico en el cajón	***CID
6	Total bruto de impuestos 1	GRS TAX1	50	Metálico+cheque en el cajón	CA+CH ID
7	Total de impuestos 1 de registros de devoluciones	RFD TAX1	51	Vuelta de cheques	CHK/CG
8	Total neto de impuestos 1	TAX1	52	Venta de comisión 1	COM. SAL1
9	Exención de impuestos 1	TX1 EXPT	53	Venta de comisión 2	COM. SAL2
10	Subtotal neto de imponible 2	TAX2 ST	54	Sin venta de comisión	NON COM.
11	Total bruto de impuestos 2	GRS TAX2	55	Total de secciones (+)	*DEPT TL
12	Total de impuestos 2 de registros de devoluciones	RFD TAX2	56	Total de secciones (-)	DEPT(-)
13	Total neto de impuestos 2	TAX2	57	Total de secciones de devolución de botellas (+)	*BTTL TL
14	Exención de impuestos 2	TX2 EXPT	58	Total de secciones de devolución de botellas (-)	BTTL(-)
15	Subtotal neto de imponible 3	TAX3 ST	59	Subtotal	SUBTOTAL
16	Total bruto de impuestos 3	GRS TAX3	60	Subtotal de mercancías	MDSE ST
17	Total de impuestos 3 de registros de devoluciones	RFD TAX3	61	Total	*** TOTAL
18	Total neto de impuestos 3	TAX3	62	Cambio	CHANGE
19	Exención de impuestos 3	TX3 EXPT	63	Artículos	ITEMS
20	Subtotal neto de imponible 4	TAX4 ST	64	Importe de comisión 1	COM. AMT1
21	Total bruto de impuestos 4	GRS TAX4	65	Importe de comisión 2	COM. AMT2
22	Total de impuestos 4 de registros de devoluciones	RFD TAX4	66	Total de importe de comisión	COM. TTL
23	Total neto de impuestos 4	TAX4	67	Título de informe de secciones	DEPT
24	Exención de impuestos 4	TX4 EXPT	68	Título de informe de PLU/UPC	PLU/UPC
25	Total bruto de impuestos manuales	GRS MTAX	69	Título de informe de transacciones	TRANS.
26	Total de impuestos manuales de devoluciones	RFD MTAX	70	Título de informe de dependientes	CLERK
27	Total neto de impuestos manuales	M-TAX	71	Título de informe horario	HOURLY
28	Total de impuestos	TTL TAX	72	Título de informe diario	DAILY
29	Neto	NET	73	Título de informe de grupo	GROUP
30	Total de ventas incluyendo el total de impuestos	NET2	74	Total en el cajón	TL-ID
31	Devoluciones	REFUND	75	Símbolo de no adición	#
32	Cancelación de artículos	VOID	76	Título de copia de recibo	COPY
33	Modo de cancelación	VOID	77	Grupo 1	GROUP01
34	Cancelación del administrador	MGR VD	78	Grupo 2	GROUP02
35	Cancelación de subtotal	SBTL VD	79	Grupo 3	GROUP03
36	Sin venta	NO SALE	80	Grupo 4	GROUP04
37	Recibido a cuenta	*** RA	81	Grupo 5	GROUP05
38	Pagos	*** PO	82	Grupo 6	GROUP06
39	Contador de clientes	TRANS CT	83	Grupo 7	GROUP07
40	Total de ventas	NET3	84	Grupo 8	GROUP08
41	Metálico	CASH	85	Grupo 9	GROUP09
42	Cheque	CHECK	* 86	Vuelta	DUE
43	Cargo bruto 1	CHARGE	* 87	Borrado del ST imponible para todos los impuestos	TAX ST
44	Cargo de devolución 1	CHARGE-			

Nota

Los elementos marcados con “*” son sólo para la visualización.

■ Nombres de dependiente

Procedimiento

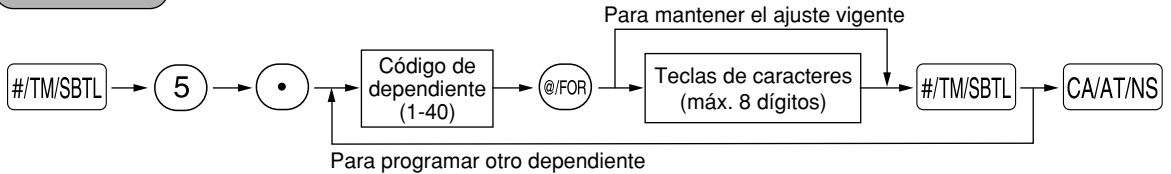

■ Mensajes de membrete

La caja registradora puede imprimir mensajes programados en cada recibo. En el modelo estándar, se imprime el membrete gráfico en el recibo. Si desea imprimir mensajes de membrete, cambie el formato de impresión de mensajes de membrete.

Procedimiento

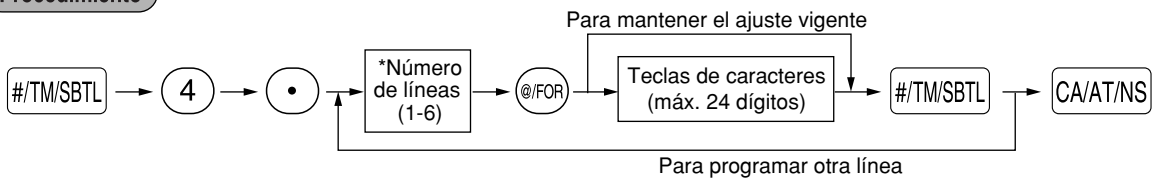

- * Tipo de "Mensaje de 3 líneas de encabezamiento": 1 a 3
- Tipo de "Mensaje de 3 líneas de pie de recibo": 4 a 6
- Tipo de "Mensaje de 6 líneas de encabezamiento": 1 a 6
- Tipo de "Mensaje de 3 líneas de encabezamiento y 3 líneas de pie de recibo": 1 a 6 (1 a 3 como encabezamiento, 4 a 6 como pie de recibo)

■ Símbolo de divisas

El símbolo de divisas para la tecla `CLK#/CONV` se imprime con un importe de cambio de divisas.

Procedimiento

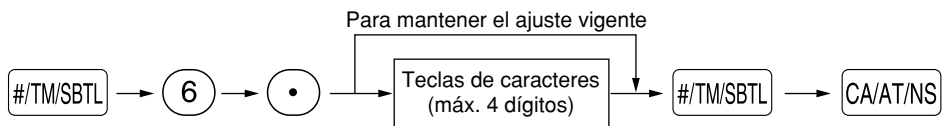

PROGRAMACION AVANZADA

1 Programación de número de caja registradora y de número consecutivo

El número de caja registradora y el número consecutivo se imprimen en el recibo y en el registro diario.

■ Número de caja registradora

Procedimiento

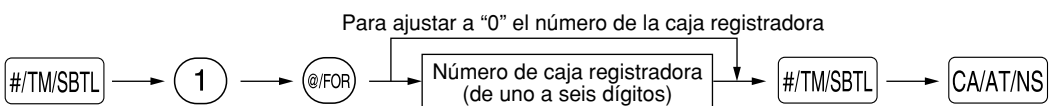

■ Ajuste de números consecutivos

Procedimiento

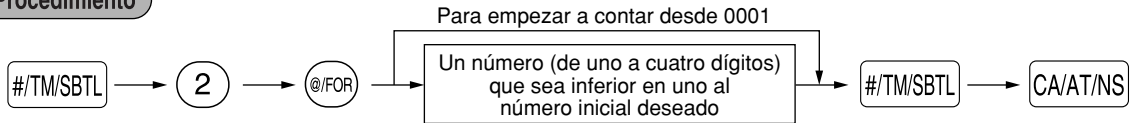

2 Programación 1 de selección de diversas funciones

Procedimiento

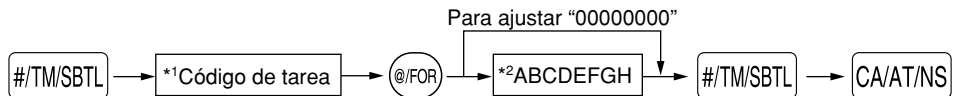

*1 Introduzca el código de tarea empleando las teclas numéricas especificadas en cada sección de abajo.

*2 Los detalles de la entrada de datos se enumeran en cada tabla de cada sección de abajo.

Podrá seguir la programación hasta que pulse la tecla CA/AT/NS para la programación que se describe en esta sección. Para seguir la programación, repita desde la entrada de un código de tarea.

■ Selección de función para teclas misceláneas

Código de tarea: 5

* Elemento:	Selección:	Registro:
A PO en el modo REG	Habilitar la operación PO en el modo REG* Inhabilitarla	0 1
B RA en el modo REG	Habilitar la operación RA en el modo REG* Inhabilitarla	0 1
C Cancelación de subtotal en el modo REG	Habilitar la cancelación de subtotal en el modo REG* Inhabilitarla	0 1
D Cancelación indirecta en el modo REG	Habilitar la cancelación indirecta en el modo REG* Inhabilitarla	0 1
E Cancelación directa en el modo REG	Habilitar la cancelación directa en el modo REG* Inhabilitarla	0 1
F Disponibilidad de la tecla de devoluciones	Habilitar registros de devolución en el modo REG* Inhabilitarlos	0 1
G No venta en el modo REG	Habilitar las operaciones de no venta en el modo REG* Inhabilitarlas	0 1
H Disponibilidad de cantidades fraccionarias	Habilitar el registro de cantidades fraccionarias Inhabilitarlo*	0 1

■ Formato de impresión

Código de tarea: 6

* Elemento:	Selección:	Registro:
A Introduzca siempre 0.	(Posición fija)	0
B Introduzca siempre 0.	(Posición fija)	0
C Impresión de la hora en todos los recibos/registro diario	Habilitar la impresión de la hora* Inhabilitarla	0 1
D Impresión de la fecha en todos los recibos/registro diario	Habilitar la impresión de la fecha* Inhabilitarla	0 1
E Impresión del N.º consecutivo en todos los recibos/registro diario	Habilitar la impresión del N.º consecutivo* Inhabilitarla	0 1
F Introduzca siempre 0.	(Posición fija)	0
G Salto de ceros para informe de PLU/UPC	Inhabilitar el salto de ceros Habilitar el salto de ceros*	0 1
H Salto de ceros para informes de ventas completas, de dependientes, horarios y neto diario	Inhabilitar el salto de ceros Habilitar el salto de ceros*	0 1

■ Formato de impresión de recibos

Código de tarea: 7

* Elemento:	Selección:	Registro:	
A	Introduzca siempre 0. (Posición fija)	0	
B	Introduzca siempre 0. (Posición fija)	0	
C	Impresión de subtotal con una pulsación de la tecla de subtotal	Inhabilitar la impresión de subtotales* Habilitarla	0 1
D	Impresión de subtotal de mercancías con una pulsación de la tecla de subtotal de mercancías	Inhabilitar la impresión de subtotal de mercancías* Habilitarla	0 1
E	Introduzca siempre 0. (Posición fija)	0	
F	Introduzca siempre 0. (Posición fija)	0	
G	Introduzca siempre 0. (Posición fija)	0	
H	Impresión del número de compras	Habilitar la impresión del número de compras* Inhabilitarla	0 1

■ Selección de función para impuestos

Código de tarea: 15

* Elemento:	Selección:	Registro:	
A	Introduzca siempre 0. (Posición fija)	0	
B	Introduzca siempre 0. (Posición fija)	0	
C	Introduzca siempre 0. (Posición fija)	0	
D	Introduzca siempre 0. (Posición fija)	0	
E	Introduzca siempre 0. (Posición fija)	0	
F	Introduzca siempre 0. (Posición fija)	0	
G	Disponibilidad de borrado de los impuestos en el modo REG	Habilitar el borrado de impuestos en el modo REG* Inhabilitarlo	0 1
H	Disponibilidad de entrada de impuestos manuales en el modo REG	Habilitar la entrada de impuestos manuales en el modo REG* Inhabilitarla	0 1

■ Selección de función para códigos de UPC

Código de tarea: 16

* Elemento:	Selección:	Registro:	
A	Introduzca siempre 0. (Posición fija)	0	
B	Introduzca siempre 0. (Posición fija)	0	
C	Impresión de códigos de sección/PLU/UPC en el registro diario	Inhabilitar la impresión de códigos de sección/PLU/UPC en el registro diario* Habilitarla	0 1
D	Impresión de códigos de sección/PLU/UPC en el recibo	Inhabilitar la impresión de códigos de sección/PLU/UPC en el recibo* Habilitarla	0 1
E	Función de aprendizaje de UPC	Habilitar la función de aprendizaje de UPC* Inhabilitarla	0 1
F	Registro de precio después de códigos de ISBN o ISSN	Registro de precio obligatorio* Inhibir el registro de precio	0 1
G	Codificación de precios PLU/UPC en el registro de devolución	Habilitar la codificación de precios PLU/UPC* Inhabilitarla	0 1
H	Comprobación de C/D (dígito de cheque) para códigos de UPC	Inhabilitar la comprobación de C/D* Habilitarla	0 1

Registro de precio después de códigos de ISBN o ISSN

Cuando selecciona “registro de precio obligatorio”, la caja registradora requiere un registro de precio cuando se introduce un código de ISBN o ISSN. Cuando selecciona “Inhibir el registro de precio”, no se pueden introducir los códigos de ISBN e ISSN.

■ Otras programaciones

Código de tarea: 61

* Elemento:	Selección:	Registro:	
A	Introduzca siempre 0. (Posición fija)	0	
B	Introduzca siempre 0. (Posición fija)	0	
C	Disponibilidad de sección/PLU/UPC negativas	Inhabilitar la programación de sección/ PLU/UPC negativas Habilitarla*	0 1
D	Trato fraccionario	Redondeo (4 por defecto, 5 por exceso)* Aumento a la unidad Descartar el trato fraccionario	0 1 2
E	Empleo de la tecla 00	Empleo de la tecla 00 como tecla 00* Empleo de la tecla 00 como tecla 000	0 1
F	Formato de la hora	Empleo del formato de 12 horas* Empleo del formato de 24 horas	0 1
G	Formato de la fecha	Empleo del formato de mes-día-año* Empleo del formato de día-mes-año Empleo del formato de año-mes-día	0 1 2
H	Posición del punto decimal (desde la derecha) (TAB)		0 a 3 (ajuste inicial: 2)

Código de tarea: 62

* Elemento:	Selección:	Registro:	
A	Introduzca siempre 0. (Posición fija)	0	
B	Activación del pitido de error	Por error de bloqueo* Por operación incorrecta	0 1
C	Disponibilidad del sonido de accionamiento de teclas	Habilitar el sonido* Inhabilitarlo	0 1
D	Teclado con memoria intermedia	Sí* No	0 1
E	Disponibilidad de la operación del modo de cancelación	Habilitar la operación en el modo de cancelación* Inhabilitarla	0 1
F	Impresión de datos de entradas en el modo de cancelación en los informes Z2	Habilitar la impresión de datos de entradas en el modo de cancelación en los informes Z2* Inhabilitarla	0 1
G	Impresión de datos de entradas en el modo de cancelación en los informes Z1	Habilitar la impresión de datos de entradas en el modo de cancelación en los informes Z1* Inhabilitarla	0 1
H	Adición de datos de total de ventas horario en el modo de cancelación	No* Sí	0 1

Código de tarea: 66

* Elemento:	Selección:	Registro:	
A	Impresión de un recibo después de la transacción	Sólo el total Detalles*	0 1
B	Impresión del importe cuando el precio unitario de PLU/UPC es cero	Inhabilitar la impresión* Habilitarla	0 1
C	Impresión del subtotal para conversión de déficit	Habilitar la impresión* Inhabilitarla	0 1
D	Introduzca siempre 0. (Posición fija)		0
E	Introduzca siempre 0. (Posición fija)		0
F	Introduzca siempre 0. (Posición fija)		0
G	Impresión del mensaje del membrete en el registro diario	Inhabilitar la impresión del mensaje del membrete en el registro diario* Habilitar la impresión del mensaje del membrete en el registro diario	0 1
H	Impresión de pie de recibo	Impresión de pie de recibo en todos los recibos* Impresión de pie de recibo con la tecla de función seleccionada en el momento de la finalización	0 1

Código de tarea: 70

* Elemento:	Selección:	Registro:
A	Cómputo de precios divididos	Cantidad*
		Paquete
B	Disponibilidad de entrada de precios con multiplicación/división	Habilitar sólo la entrada de multiplicación*
		Habilitar la entrada de multiplicación y la de división de precios
C	Introduzca siempre 0.	(Posición fija)
D	Introduzca siempre 0.	(Posición fija)
E	Introduzca siempre 0.	(Posición fija)
F	Introduzca siempre 0.	(Posición fija)
G	Introduzca siempre 0.	(Posición fija)
H	Introduzca siempre 0.	(Posición fija)

3 Programación 2 de selección de diversas funciones

Modo de ahorro de energía

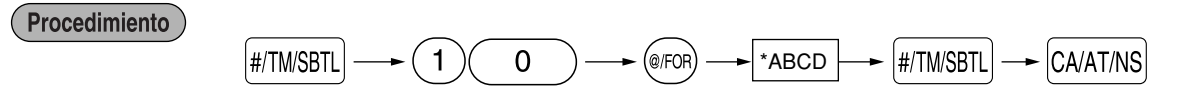

* Elemento:	Selección:	Registro:
A	Entrar en el modo de ahorro de energía cuando se visualice la hora	Si*
		No
B a D	Tiempo (min.) para entrar en el modo de ahorro de energía desde que se efectuó la última operación	001-254 ó 999 (Ajuste inicial: 030)

Nota Cuando se ajusta 999 para B a D, se inhabilita el establecimiento en el modo de ahorro de energía.

Formato de impresión de mensajes de membrete

Podrá seleccionar el número de líneas del mensaje del membrete, y la posición en la que se imprime en el recibo. Para los detalles del tipo de mensaje del membrete, consulte el apartado de “Mensajes de membrete” de la página 29.

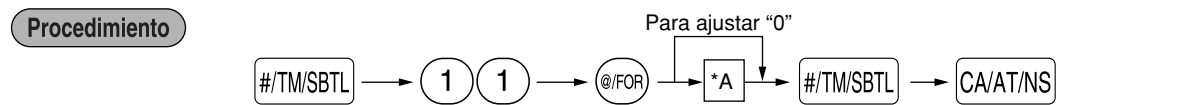

- *A: Tipo de mensaje del membrete
- 0: Mensaje de 3 líneas de encabezamiento sin membrete gráfico
 - 1: Sólo membrete gráfico (ajuste inicial)
 - 2: Mensaje de 3 líneas de pie de recibo con membrete gráfico
 - 3: Mensaje de 6 líneas de encabezamiento
 - 4: Mensaje de 3 líneas de encabezamiento con membrete gráfico
 - 5: Mensaje de 3 líneas de encabezamiento y mensaje de 3 líneas de pie de recibo

■ Bloqueo de importe alto (HALO) para metálico en el cajón (CID) (centinela)

Procedimiento

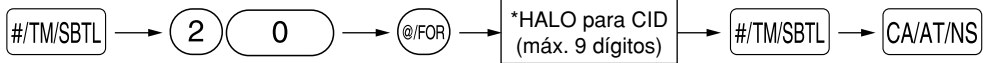

(Ajuste inicial: 9999999,99)

■ Ajuste de fin de intervalo en línea

Procedimiento

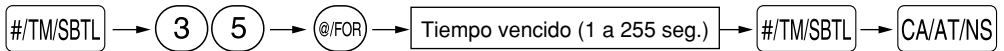

(Ajuste inicial: 007)

■ Densidad de la impresora térmica

Procedimiento

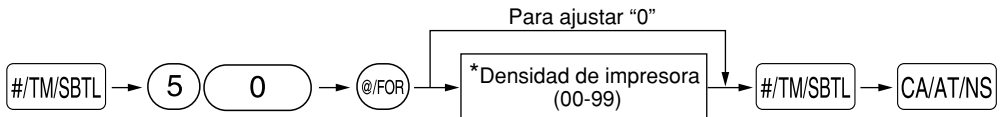

* En el ajuste inicial se ajusta 50. Para oscurecer la impresión, ajuste un número mayor, y para que sea más clara, ajuste un número menor.

■ Selección del idioma

Procedimiento

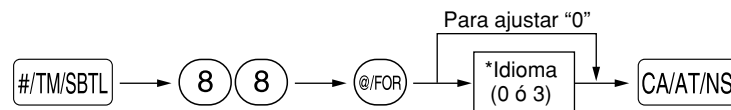

*Idioma: 0: Inglés 3: Español

Ejemplo de operación de teclas

```

    #/TM/SBTL 88 @/FOR
    3 CA/AT/NS
  
```

Impresión

```

    *PGM*
    #88      3
  
```

Precaución

Cuando cambie el idioma, el texto como el del nombre de dependiente, mensaje de membrete y el texto de funciones se repondrá a los ajustes iniciales.

■ Especificación de dependientes de instrucción para el modo de instrucción

Para los detalles sobre la instrucción de dependientes, consulte el "MODO DE INSTRUCCION" en la página 35.

Procedimiento

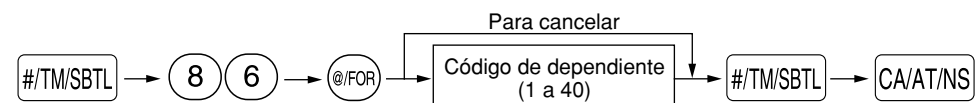

■ Programación de la tecla AUTO — Tecla de secuencia automática

Si se programan transacciones que se realizan con frecuencia o secuencias de informes para la tecla **AUTO**, puede llamar esas transacciones y/o informes pulsando simplemente la tecla **AUTO** en las operaciones de teclas.

Procedimiento

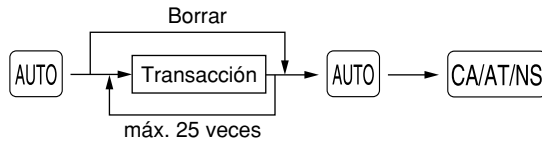

Programación para **AUTO**; registro de un artículo de PLU 2 (precio unitario programado: 1,50) y de un artículo de la sección 6 (precio unitario: 1,00)

Ejemplo de operación de teclas

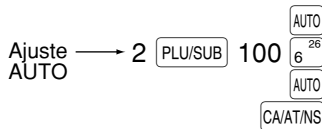

4 Lectura de programas almacenados

La máquina le permitirá leer todos los programas almacenados en el modo PGM.

■ Secuencia de las teclas para la lectura de programas almacenados

Nombre del informe	Secuencia de teclas
Informe de programación 1	CA/AT/NS
Informe de programación 2	2 → CA/AT/NS
Informe de programación de tecla automática	1 → CA/AT/NS
Informe de programación de densidad de impresora	3 → CA/AT/NS
Informe de programación de PLU/UPC (Margen)	Código de PLU/UPC inicial → @/FOR → Código de PLU/UPC final → PLU/SUB
(Todo)	PLU/SUB

Cuando se lea sólo un código de PLU/UPC

Nota Para detener la lectura del informe de programación de PLU/UPC, gire el selector de modo a la posición MGR.

MODO DE INSTRUCCIÓN

El modo de instrucción se utiliza cuando el operador o el administrador practica las operaciones de la caja registradora.

Cuando se selecciona un dependiente que está en instrucción, la máquina se establece automáticamente en el modo de instrucción.

La operación de instrucción sólo es válida en los modos REG, MGR y VOID. La memoria del dependiente correspondiente sólo se actualiza en el modo de instrucción.

LECTURA (X) Y REPOSICIÓN (Z) DE LOS TOTALES DE VENTAS

- Utilice la función de lectura (X) cuando necesite leer la información de ventas registrada desde la última reposición. Puede obtener esta lectura todas las veces que quiera dado que no afecta a la memoria de la registradora.
- Utilice la función de reposición (Z) cuando necesite borrar la memoria de la registradora. La reposición imprime toda la información de ventas y borra toda la memoria excepto para GT1 a GT3, GT de instrucción, cuenta de reposición y número consecutivo.

1 Resumen de informes de lectura (X) y reposición (Z)

Informes X1 y Z1: Informes de ventas diarias

Informes X2 y Z2: Informes de consolidación periódica (mensual)

Para hacer un informe X o Z, gire el selector de modo a la posición apropiada consultando la columna de "Posición del selector de modo" mostrada en la tabla siguiente, y emplee la siguiente secuencia de teclas correspondiente.

Elemento	Posición del selector de modo			Operación de teclas
	OPX/Z	X1/Z1	X2/Z2	
Informe rápido: (Sólo visualización) Para borrar la visualización, pulse la tecla (CL) o gire el selector de modo a otra posición.	X	—	—	<p>Código de sección → DEPT# : Importe total de sección</p> <p>[Para las secciones 1 a 20: Tecla de sección (1²¹ a 20⁴⁰) Para las secciones 21 a 40: DEPTSHIFT → Tecla de sección (1²¹ a 20⁴⁰)]</p> <p>Tecla @/FOR: Importe de metálico en el cajón</p> <p>Tecla CA/AT/NS: Total de ventas</p>
Informe de ventas completo	—	X1, Z1	X2, Z2	Lectura: CA/AT/NS Reposición: • → CA/AT/NS
Informe de sección	—	X1	X2	Lectura: DEPT#
Informe del total de grupo individual en sección	—	X1	X2	Lectura: Número de grupo → @/FOR → DEPT#
Informe del total de todos los grupos en sección	—	X1	X2	Lectura: 0 → @/FOR → DEPT#
Informe de PLU/UPC por margen designado	—	X1, Z1	X2, Z2	<p>Todas las PLU/UPC</p> <p>Lectura: Código de PLU/UPC inicial → @/FOR → Código de PLU/UPC final → PLU/SUB</p> <p>Reposición: Todas las PLU/UPC</p> <p>Código de PLU/UPC inicial → @/FOR → Código de PLU/UPC final → • → PLU/SUB</p>
Informe de PLU/UPC por sección asociada	—	X1	X2	Lectura: Código de sección asociada → DEPTSHIFT → PLU/SUB
Informe de transacciones	—	X1	X2	Lectura: 1 → CA/AT/NS

COMO EMPLEAR UNA TARJETA DE MEMORIA SD

Podrá cambiar datos mediante una tarjeta de memoria SD entre su caja registradora y un ordenador al manejar los datos de su caja registradora empleando la "Herramienta de ayuda a clientes" (Customer Support Tool) de software de ordenador SHARP.

La Herramienta de ayuda a clientes puede descargarse desde el sitio Web de Sharp.

Visite el sitio Web de Sharp: <http://www.sharpusa.com/registersoftware>

También podrá memorizar todos los datos necesarios de la caja registradora en una tarjeta de memoria SD para mayor seguridad.

Este manual de instrucciones describe sólo esas operaciones necesarias en la caja registradora. Para más detalles, consulte la sección de ayuda en la "Herramienta de ayuda a clientes".

■ En caso de error de la tarjeta SD

Si ocurre un error mientras se están transfiriendo datos desde la caja registradora a la tarjeta de memoria SD insertada y viceversa, se indicará con el mensaje de error correspondiente que se mostrará en el visualizador para el operador. Pulse la tecla (CL) para borrar el error, y luego tome las medidas correspondientes.

Tabla de mensajes de error de SD

Visualización (Mensaje de error)	Estado de error y contramedidas
NO CARD	No hay ninguna tarjeta de memoria SD. Inserte una tarjeta de memoria SD en la ranura de la tarjeta SD o vuelva a insertarla correctamente.
CARD PROTECT	El interruptor de protección contra escritura de la tarjeta de memoria SD está en la posición "PROTEGIDA". Ajuste el interruptor en la posición "DESPROTEGIDA".
CARD FULL	La tarjeta de memoria SD está llena. Borre los datos innecesarios de la tarjeta empleando un ordenador o cambie la tarjeta por otra nueva. Para emplear una tarjeta de memoria SD nueva, deberá haberla formateado de antemano.
ACCESS ERROR	La tarjeta de memoria SD no tiene los datos necesarios. Cámbiela por otra tarjeta de memoria SD que contenga los datos necesarios.
FILE FAILED	Los datos guardados en la tarjeta de memoria SD son incorrectos. Guarde los datos correctos en la tarjeta de memoria SD empleando un ordenador.
OVER LIMIT.	Se ha excedido el número máximo permisible de veces de escritura de datos de ventas. Borre los datos que sean innecesarios de la tarjeta de memoria SD empleando un ordenador o cambie la tarjeta por otra nueva. Para emplear una tarjeta de memoria SD nueva, deberá haberla formateado de antemano.
POWER OFF	Ha ocurrido un apagón mientras se estaba accediendo a la tarjeta de memoria SD. Efectúe de nuevo la operación interrumpida desde el principio después de haberse restaurado la alimentación.
SD CANCEL	Se ha cancelado la operación de transferencia de datos. Efectúe de nuevo la misma operación desde el principio.
SD ERROR	Ha ocurrido un error distinto a los que se han mencionado arriba mientras se estaba accediendo a la tarjeta de memoria SD. Efectúe de nuevo la operación interrumpida desde el principio.

■ Inserción y extracción de una tarjeta de memoria SD

La ranura de la tarjeta SD está al lado derecho de la caja registradora y tiene una cubierta.

Inserción de una tarjeta de memoria SD

Inserte una tarjeta de memoria SD en la ranura de la tarjeta SD con el logotipo SD impreso encarado hacia arriba. Empuje la tarjeta con el dedo hasta oír un sonido seco y suéltela lentamente.

Extracción de la tarjeta de memoria SD

Empuje suavemente la tarjeta con el dedo y suéltela. La tarjeta saldrá.

Nota

- Cuando se inserte o extraiga la tarjeta de memoria SD, asegúrese de soltarla lentamente. De lo contrario, es posible que la tarjeta salga súbitamente y hiera el dedo.
- No toque ni extraiga nunca la tarjeta de memoria SD mientras se esté accediendo. De lo contrario, podrían dañarse los datos almacenados en ella.
- Si ocurre un apagón, se desenchufa la caja registradora, o se gira el selector de modo a una posición diferente mientras se está accediendo a la tarjeta de memoria SD, podrían dañarse los datos almacenados en esa tarjeta.

Formateo de una tarjeta de memoria SD

Cuando emplee una tarjeta de memoria SD nueva por primera vez, asegúrese de formatearla en su caja registradora antes de escribir los datos de programación en ella.

No formatee nunca ninguna tarjeta de memoria SD que contenga datos. De lo contrario, se borrarán todos los datos almacenados en la tarjeta.

Procedimiento Ajuste el selector de modo en la posición **PGM**.

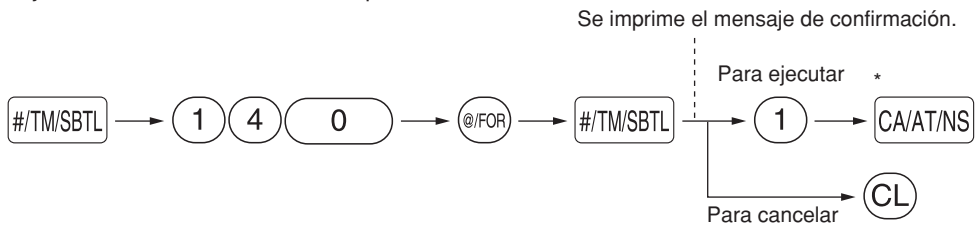

* El mensaje "ACCESSING CARD" aparecerá y se quedará en el visualizador hasta que se formatee completamente la tarjeta de memoria SD. Cuando se finalice el formateo, se imprimirá el mensaje "SD FINAL". Si ocurre un error, se imprimirá el mensaje de error correspondiente.

Memorización y restauración de todos los datos

Procedimiento Ajuste el selector de modo en la posición **PGM**.

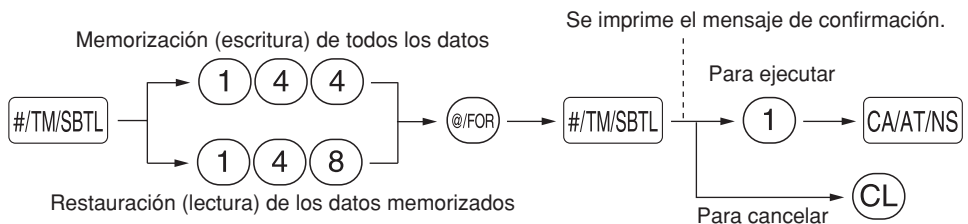

Nota

Si memoriza todos los datos empleando una tarjeta de memoria SD que contenga datos, los datos existentes se borrarán y se reemplazarán por los datos memorizados nuevamente. Si necesita los datos existentes, emplee otra tarjeta de memoria SD.

Lectura de los datos de logotipos gráficos

Procedimiento Ajuste el selector de modo en la posición **PGM**.

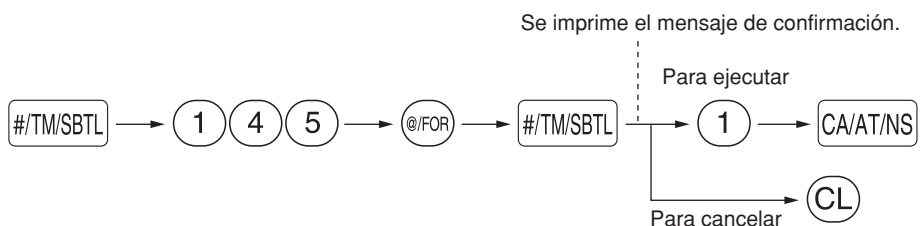

■ Escritura y lectura de todos los datos de programación

Podrá escribir todos los datos de programación de la caja registradora en una tarjeta de memoria SD (Escritura). Los datos existentes de programación de la tarjeta se reemplazarán por los datos escritos nuevamente.

También podrá reemplazar los datos de programación almacenados en la caja registradora por los almacenados en una tarjeta de memoria SD cargando ésta en la caja registradora (Lectura).

Procedimiento Ajuste el selector de modo en la posición **PGM**.

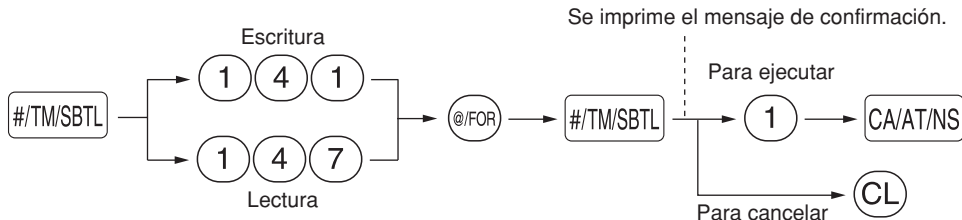

■ Escritura de datos de ventas

Escriba todos los datos existentes de ventas (totales diario y periódico) en una tarjeta de memoria SD. Podrá escribir los datos en la misma tarjeta un máximo de 400 veces a menos que la tarjeta quede llena.

Procedimiento Ajuste el selector de modo en la posición **X1/Z1**.

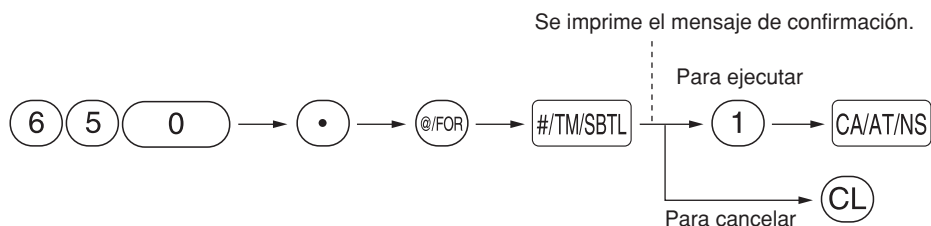

MANTENIMIENTO PARA EL OPERADOR

1 En caso de corte de la alimentación

Si se corta la alimentación, la registradora retiene el contenido de su memoria y toda la información sobre las entradas de ventas.

- Cuando el corte de la alimentación ocurre en el estado libre de la registradora o cuando está realizando una entrada, la máquina retorna al funcionamiento normal después de recuperarse la alimentación.
- Cuando el corte de la alimentación ocurre durante un ciclo de impresión, la registradora imprime "=====" y lleva a cabo después el procedimiento de impresión correcto después de recuperarse la alimentación.

2 En el caso de error de impresora

Si se termina el papel de la impresora, se parará la impresora, y aparecerá "PAPER EMPTY" en el visualizador. No pueden aceptarse los registros de teclas. Instale un rollo de papel nuevo, y luego pulse la tecla (CL).

Si se levanta el cabezal de impresión, se parará la impresora y aparecerá "HEAD UP" en el visualizador. No pueden aceptarse los registros de teclas. Vuelva a colocar el cabezal de impresión en la posición correcta, y entonces pulse la tecla (CL).

3 Precauciones al manejar la impresora

- Si no va a utilizar la caja registradora durante mucho tiempo, tire de la palanca de liberación del cabezal de impresión hacia usted para que el cabezal de impresión se aleje de la placa. (posición de cabezal levantado)
- Evite los lugares polvorientos y húmedos, la luz directa del sol y el polvo metálico (en esta máquina se emplean un imán permanente y un electroimán.)
- Utilice la palanca de liberación del cabezal de impresión sólo cuando sea necesario.
- No tire nunca del papel cuando esté en contacto con el cabezal de impresión. Suelte primero el cabezal con la palanca de liberación del cabezal de impresión y luego quite el papel.
- No toque nunca la superficie del cabezal de impresión.
- No toque nunca el cabezal de impresión ni el motor durante la impresión ni antes de que se hayan enfriado.

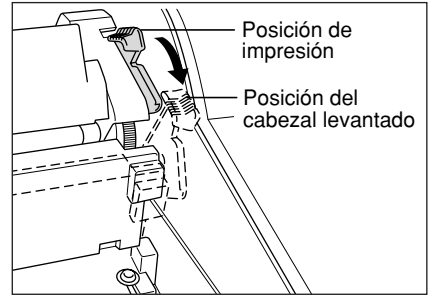

4 Reemplazo del rollo de papel

Utilice siempre rollos de papel especificados por SHARP.

Si usa otros rollos de papel que no sean los especificados, pueden originarse atascos de papel y funcionar mal la caja registradora.

(Forma de colocar el rollo de papel)

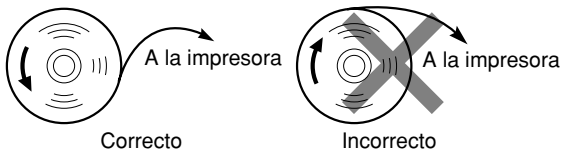

(Forma de cortar el extremo del papel)

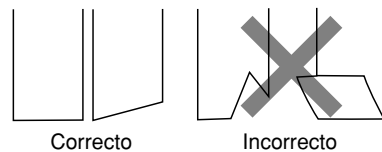

■ Extracción del rollo de papel

Cuando aparezca entintado de color rojo en el rollo de papel, significa que es el momento de reemplazarlo.

Reemplace el rollo de papel por otro nuevo. Si no piensa utilizar la registradora durante mucho tiempo, extraiga el rollo de papel y guárdelo en el lugar apropiado.

Precaución: El cortador de papel está montado en la impresora (lado de recibos). Tenga mucho cuidado para no cortarse por accidente.

Extracción del rollo de papel de recibos:

1. Gire el selector de modo a la posición REG con el cable de alimentación enchufado.
2. Extraiga la cubierta de la impresora.
3. Corte el papel detrás de la impresora y cerca del rollo de papel.
4. Pulse la tecla  hasta que el papel que queda en la impresora salga por completo.
5. Extraiga el rollo de papel del soporte del rollo de papel del lado de recibos.

Nota No tire del papel por la impresora.

Extracción del rollo de papel de registro diario:

1. Gire el selector de modo a la posición REG con el cable de alimentación enchufado.
2. Extraiga la cubierta de la impresora.
3. Pulse la tecla  para hacer avanzar el papel de registro diario hasta que la parte impresa salga del paso.
4. Corte el papel y extraiga el carrete de toma.

5. Corte el papel detrás de la impresora y cerca del rollo de papel.
6. Pulse la tecla  hasta que el papel que queda en la impresora salga por completo.
7. Extraiga el rollo de papel del soporte del rollo de papel del lado de registro diario.

Nota *No tire del papel por la impresora.*

8. Extraiga el lado exterior del carrete de toma.
9. Extraiga el rollo de registro diario impreso del carrete de toma.



■ Instalación del rollo de papel

Precaución: El cortador de papel está montado en la impresora (lado de recibos). Tenga mucho cuidado para no cortarse por accidente.

Instalación del rollo de papel de recibos:

1. Gire el selector de modo a la posición REG con el cable de alimentación enchufado.
2. Extraiga la cubierta de la impresora.
3. Compruebe que la palanca de liberación del cabezal de impresión esté en su posición de impresión.
4. Coloque correctamente el papel en el soporte del rollo de papel del lado de recibos.
5. Inserte el extremo del papel en la guía de papel de la impresora hasta que entre en el dispositivo de alimentación automática de la impresora y salga por la parte superior de la impresora.
Si la impresora no engancha el papel, haga avanzar el papel mientras pulsa la tecla .
6. Corte el papel sobrante empleando el cortador de papel, y vuelva a colocar la cubierta de la impresora.

Instalación del rollo de papel de registro diario:

1. Gire el selector de modo a la posición REG con el cable de alimentación enchufado.
2. Extraiga la cubierta de la impresora.
3. Compruebe que la palanca de liberación del cabezal de impresión esté en su posición de impresión.
4. Coloque correctamente el papel en el soporte del rollo de papel del lado de registro diario.
5. Inserte el extremo del papel en la guía de papel de la impresora hasta que entre en el dispositivo de alimentación automática de la impresora y salga por la parte superior de la impresora.
Si la impresora no engancha el papel, haga avanzar el papel mientras pulsa la tecla .
6. Inserte el extremo del papel en la ranura del carrete de papel. (Pulse la tecla  para hacer avanzar más papel si es necesario.)
7. Bobine el papel dos o tres vueltas en torno al eje del carrete.
8. Coloque el carrete en el rodamiento, y pulse la tecla  para sacar la flojedad excesiva del papel.
9. Vuelva a colocar la cubierta de la impresora.

5 Extracción del papel atascado

Precaución: El cortador de papel está montado en la impresora (lado de recibos). Tenga mucho cuidado para no cortarse por accidente. No toque nunca el cabezal de impresión inmediatamente después de imprimir, porque éste estará aún caliente.

1. Extraiga la cubierta de la impresora.
2. Tire de la palanca de liberación del cabezal de impresión completamente hacia delante (después de que la palanca se haya parado en una posición, siga empujándola hacia delante hasta que se pare de nuevo y no se pueda empujar más hacia delante).
3. Extraiga el papel atascado. Compruebe si quedan restos de papel en la impresora y, si los hubiera, quítelos.
4. Vuelva a poner la palanca de liberación del cabezal de impresión a su posición original.
5. Ponga correctamente el rollo de papel siguiendo los pasos mencionados en "Instalación del rollo de papel".
6. Vuelva a colocar la cubierta de la impresora.

6 Limpieza del cabezal de impresión

Cuando el texto impreso se oscurece o aparece borroso, el polvo del papel puede pegarse en el cabezal de impresión. Limpie el cabezal de impresión de la forma siguiente:

Precaución:

- **No toque nunca el cabezal de impresión con una herramienta ni nada que sea duro porque podría estropear el cabezal.**
- **El cortador de papel está montado en la impresora (lado de recibos). Tenga mucho cuidado para no cortarse por accidente.**

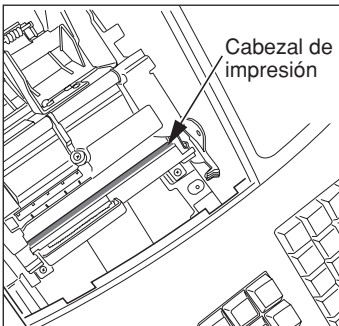

1. Gire el selector de modo a la posición OFF.
2. Extraiga la cubierta de la impresora.
3. Tire de la palanca de liberación del cabezal de impresión completamente hacia delante (después de que la palanca se haya parado en una posición, siga empujándola hacia delante hasta que se pare de nuevo y no se pueda empujar más hacia delante).
4. Limpie el cabezal de impresión con un palillo de algodón o un paño blando humedecido en alcohol etílico o alcohol isopropílico.
5. Vuelva a colocar la palanca de liberación del cabezal de impresión a su posición original inmediatamente después de terminar la limpieza.
6. Ponga correctamente el rollo de papel siguiendo los pasos mencionados en "Instalación del rollo de papel".
7. Vuelva a colocar la cubierta de la impresora.

7 Extracción del separador de dinero y del cajón

El separador de dinero de la caja registradora es extraíble. Después de terminar la jornada laboral, extraiga el separador de dinero del cajón y deje el cajón abierto. Para extraer el cajón, tire del mismo completamente hacia delante con el separador de dinero sacado. Y extráigalo levantándolo.

La caja de monedas de 6 denominaciones también es extraíble.

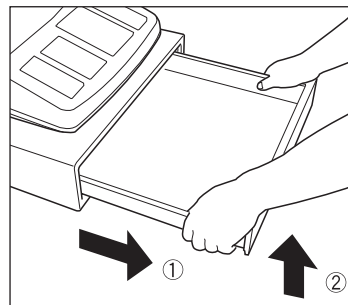
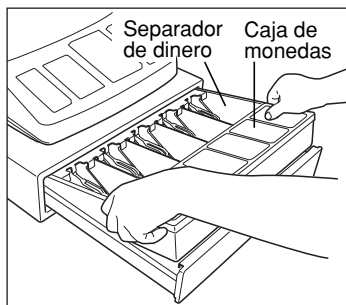

8 Abertura manual del cajón

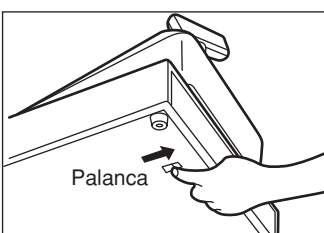

El cajón se abre automáticamente. Sin embargo, cuando haya un fallo o corte de la corriente o la registradora quede fuera de servicio, deslice la palanca situada en la parte inferior de la registradora en la dirección de la flecha. (Vea la figura a la izquierda.)

El cajón no se abrirá, sin embargo, si está cerrado con la llave.

9 Antes de solicitar el servicio de un técnico

Los casos de mal funcionamiento de la columna de la izquierda de la tabla siguiente, indicados bajo el título “Fallo”, no son necesariamente averías de la registradora. Se recomienda pues consultar la sección “Comprobación” de la columna de la derecha antes de llamar al servicio técnico.

Fallo	Comprobación
(1) El visualizador muestra los símbolos que no tienen ningún sentido.	<ul style="list-style-type: none"> • ¿Se ha inicializado correctamente la máquina como se muestra en “PARA EMPEZAR”? (Tenga presente que la inicialización borra todos los datos y ajustes programados que están almacenados en la memoria.)
(2) El visualizador no se ilumina aunque el selector de modo esté colocado en cualquier otra posición que no sea “OFF”.	<ul style="list-style-type: none"> • ¿Se suministra alimentación en la toma de corriente? • ¿Está la clavija del cable de alimentación desenchufada o mal conectada a la toma de corriente?
(3) El visualizador se ilumina, pero la registradora no responde a los registros.	<ul style="list-style-type: none"> • ¿Está el código del dependiente asignado a la registradora? • ¿Está el selector de modo bien colocado en la posición “REG”?
(4) No se emiten recibos.	<ul style="list-style-type: none"> • ¿Está el rollo de papel bien instalado? • ¿Hay algún atasco de papel? • ¿Está la función de recibos en el estado “OFF”? • ¿Está la palanca de liberación del cabezal de impresión en la posición de impresión?
(5) No sale el papel del registro diario.	<ul style="list-style-type: none"> • ¿Está el carrete de toma bien instalado en el rodamiento? • ¿Hay algún atasco de papel?
(6) La impresión no es normal.	<ul style="list-style-type: none"> • ¿Está la palanca de liberación del cabezal de impresión en la posición de impresión? • ¿Está el rollo de papel correctamente instalado?

■ Tabla de mensajes de error

Cuando se visualicen los siguientes mensajes de error, pulse la tecla (CL) y tome la acción apropiada de acuerdo con la tabla siguiente.

Mensaje de error	Estado de error	Acción
ENTRY ERROR	Error de registro	Haga el registro con las teclas correctas.
MISOPERATION	Error de operación incorrecta	Haga el registro con las teclas correctas.
NO RECORD	Se ha introducido un código no definido.	Introduzca un código correcto.
MEMORY FULL	La memoria está llena (en la programación de la tecla AUTO).	Programa la tecla AUTO con 25 pasos.
SBTL COMPUL.	Pulsación obligatoria de la tecla #T/M/SBTL para finalización directa	Pulse la tecla #T/M/SBTL y prosiga la operación.
TEND COMPUL.	Importe recibido obligatorio	Efectúe una operación de importe recibido.
NOT ASSIGNED	Falta el registro de un código de dependiente.	Efectúe un registro de código de dependiente.
OVER LIMIT.	Error de límite de rebose	Haga el registro dentro del límite de registro.
INH. OPEN PR	La entrada de precio abierto está inhibida.	Haga un registro de precio preajustado.
INH. UNIT PR	La entrada de precio preajustado está inhibida.	Haga un registro de precio abierto.
NOT NON-TEND	La finalización directa está inhibida.	Haga una operación de importe recibido.
BUFFER FULL	No se permite la cancelación del subtotal.	Finalice la transacción y corrija las entradas erróneas en el modo de cancelación.
HEAD UP	La palanca de liberación del cabezal de impresión está levantada.	Mueva la palanca hacia el carrito de toma (a la posición de impresión).
PAPER EMPTY	Un rollo de papel de recibos y/o de registro diario no está instalado o está vacío.	Instale un rollo de papel de recibos y/o de registro diario.

Nota

Los mensajes de error son los de español (cambio del ajuste de programación para selección del idioma español).

Empee estas etiquetas con las teclas de sección. Escriba los nombres de sección en las etiquetas y adhiéralas a las teclas de sección sacando primero las cubiertas transparentes de las teclas. (Haga una copia de esta página.)

Ejemplo:

Leche	21
Pan	
1	E

25	30	35	40
5	A	10	F
15	K	20	P

22	27	32	37
2	D	7	I
12	N	17	S

24	29	34	39
4	B	9	G
14	L	19	Q

21	26	31	36
1	E	6	J
11	O	16	T

23	28	33	38
3	C	8	H
13	M	18	R

MEMO

END-USER LIMITED WARRANTY

SHARP ELECTRONICS CORPORATION warrants to the first end-user purchaser (the "Purchaser") that this Sharp brand product (the "Product"), when new and shipped in its original container, will be free from defective workmanship and materials, and agrees that it will, at its option, either repair the defect or replace the defective Product or part thereof with a new or remanufactured equipment at no charge to the Purchaser for parts or labor for the period(s) set forth below.

This warranty does not apply to any appearance items of the Product nor to the additional excluded item(s) set forth below nor to any Product the exterior of which has been damaged or defaced, which has been subjected to improper voltage or other misuse, abnormal service or handling, or which has been altered or modified in design or construction.

In order to enforce the rights under this limited warranty, the Purchaser should follow the steps set forth below and provide proof of purchase to the servicer.

To the extent permitted by applicable state law, the warranties set forth herein are in lieu of, and exclusive of, all other warranties, express or implied. Specifically, ALL OTHER WARRANTIES OTHER THAN THOSE SET FORTH ABOVE ARE EXCLUDED. ALL EXPRESS AND IMPLIED WARRANTIES INCLUDING THE WARRANTIES OF MERCHANTABILITY, FITNESS FOR USE, AND FITNESS FOR A PARTICULAR PURPOSE ARE SPECIFICALLY EXCLUDED. If, under applicable state law, implied warranties may not validly be disclaimed or excluded, the duration of such implied warranties is limited to the period(s) from the date of purchase set forth below.

Neither the sales personnel of the seller nor any other person is authorized to make any warranties other than those described herein, or to extend the duration of any warranties beyond the time period described herein on behalf of Sharp.

The warranties described herein shall be the sole and exclusive warranties granted by Sharp and shall be the sole and exclusive remedy available to the Purchaser. Correction of defects, in the manner and for the period of time described herein, shall constitute complete fulfillment of all liabilities and responsibilities of Sharp to the Purchaser with respect to the Product, and shall constitute full satisfaction of all claims, whether based on contract, negligence, strict liability or otherwise. In no event shall Sharp be liable, or in any way responsible, for any damages or defects in the Product which were caused by repairs or attempted repairs performed by anyone other than an authorized servicer. Nor shall Sharp be liable or in any way responsible for any incidental or consequential economic or property damage. Some states do not allow limits on warranties or on remedies for breach in certain transactions; in such states, the limits herein may not apply.

Model Specific Section (Carry-in Service)

Your Product Model Number & Description:

XE-A42S Cash Register
(Be sure to have this information available when you need service for your product.)

Warranty Period for this Product:

One (1) year parts and 90 days labor from date of purchase

Additional Item(s) Excluded from Warranty Coverage (if any):

Any consumable items such as paper supplied with the Product.

Where to Obtain Service:

From a Sharp Authorized Servicer located in the United States. To find the location of the nearest Sharp Authorized Servicer, call SHARP toll free at 1-800-BE-SHARP.

What to do to Obtain Service:

Ship prepaid or carry in your Product to a Sharp Authorized Servicer. Be sure to have **Proof of Purchase** available. If you ship the Product, be sure it is insured and packaged securely.

SHARP®

SHARP ELECTRONICS CORPORATION

Sharp Plaza, Mahwah, New Jersey 07495-1163

1-800-BE-SHARP

For additional information and product registration,
please visit www.sharpsusa.com

SHARP CORPORATION