

# SHARP OPERATION GUIDE

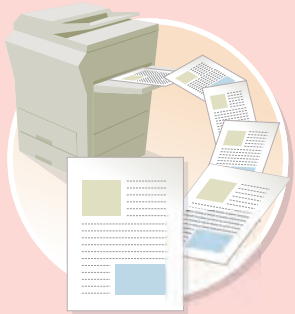

## Search based on what you want to do



MAKE A COPY

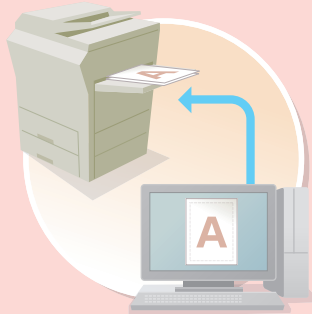

PRINT A DOCUMENT



SEND A FAX

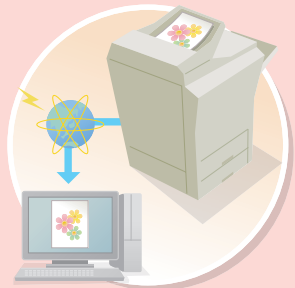

SCAN AN IMAGE /  
SEND AN INTERNET FAX

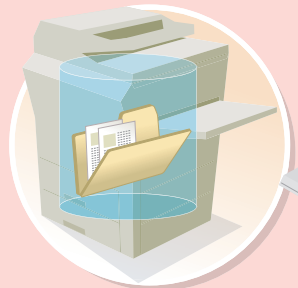

SAVE A JOB AND  
REUSE IT LATER

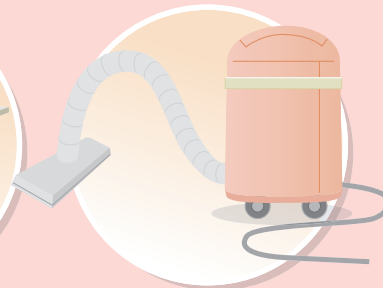

MAINTAIN  
THE MACHINE



## Search using the table of contents



BEFORE USING THE MACHINE



COPIER



PRINTER



FACSIMILE



SCANNER / INTERNET FAX



DOCUMENT FILING



SYSTEM SETTINGS



TROUBLESHOOTING

# MAKE A COPY



**Conserve**

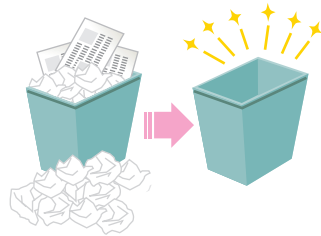

**Reduce copy mistakes**

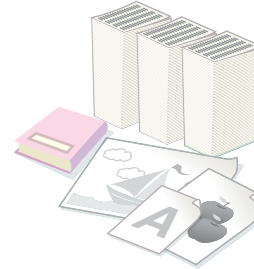

**Make a copy of this type of original**

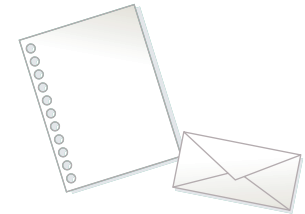

**Make a copy on this type of paper**



**Add the date or page numbers**

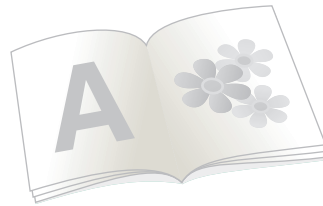

**Assemble output into a pamphlet**



**Other convenient functions**

# Conserve

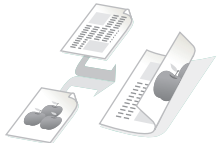

**Copy on both sides of the paper**

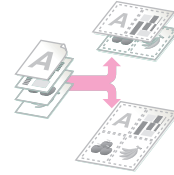

**Copy multiple pages on one side of one sheet of paper**

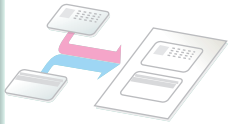

**Copy on the front and back of a card**

# Reduce copy mistakes



**Print one set of copies for proofing**



# Make a copy of this type of original

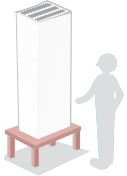

**More original pages than can be loaded at once**

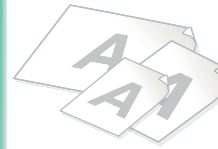

**Mixed-size originals**

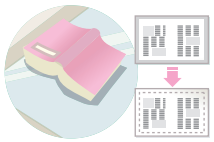

**Bulky original (shadows appear at edges)**

# Make a copy on this type of paper



**Envelopes and other  
special media**



**Transparency film**

# Add the date or page numbers



**Add the date**



**Add a stamp**



**Add the page number**



**Add text**

# Assemble output into a pamphlet

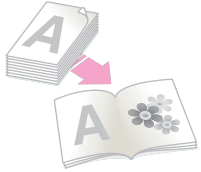

**Create a pamphlet**

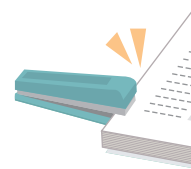

**Staple output**

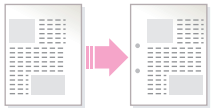

**Create a blank margin for  
hole punching**



# Other convenient functions

## Functions used for specific purposes

- Make a copy of arranged photos
- Make a mirror-image copy
- Copy onto the center of the paper
- Make a negative copy

## Convenient functions

- Give priority to a copy job
- Check the status of a reserved job
- Copy a thin original

# PRINT A DOCUMENT



**Conserve**

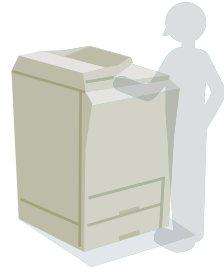

**Print without a  
computer**

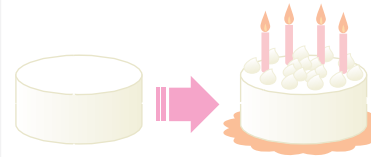

**Print attractive  
output**



**Assemble output  
into a pamphlet**

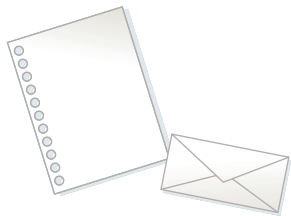

**Print on this type  
of paper**

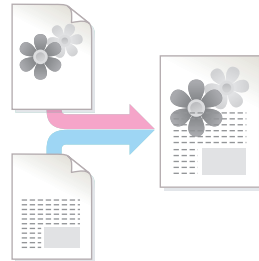

**Add text or an  
image**



**Other convenient functions**

# Conserve

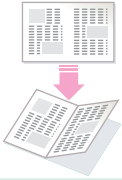

**Print on both sides of the paper**

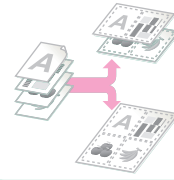

**Print multiple pages on one side of the paper**

# Print without a computer

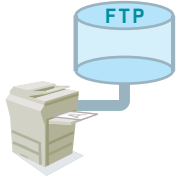

**Print a file on an FTP**



**Print a file in a USB  
memory device**



**Print a file in a network  
folder**



**Print a file stored in the  
machine**



# Print attractive output

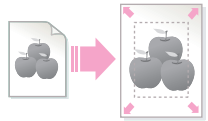

**Print matching the size of the paper**

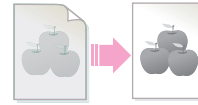

**Adjust the brightness and contrast**

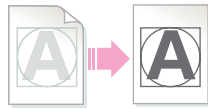

**Bring out faint text and lines**

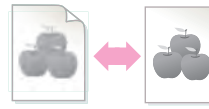

**Select the print mode**

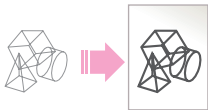

**Adjust the line widths of CAD data.**

# Assemble output into a pamphlet

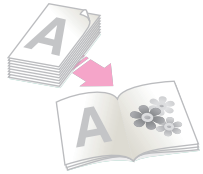

**Create a pamphlet**

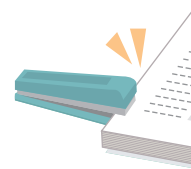

**Staple output**

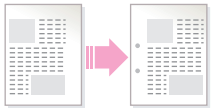

**Create a blank margin for hole punching**

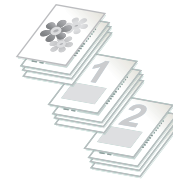

**Print specific pages on the front side of the paper**

# Print on this type of paper

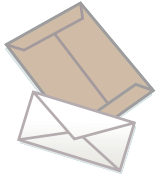

**Envelopes**



**Transparency film**

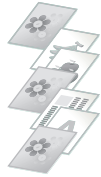

**Print specific pages on  
different paper**

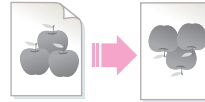

**Rotate the image 180  
degrees**

# Add text or an image

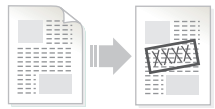

**Add a watermark to print data**

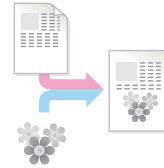

**Overlay an image on the print data**

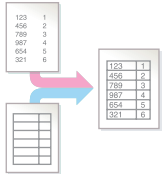

**Overlay a fixed form on the print data**



# Other convenient functions

## Correct the size or orientation of the print data

- Enlarge or reduce the print image
- Print a mirror-image

## Security is important

- Print confidentially
- Print an encrypted PDF file

## Functions used for specific purposes

- Print an "invoice copy"
- Create a large poster

## Convenient functions

- Give priority to a print job
- Store frequently used print settings
- Store a print job

# SEND A FAX



**Conserve**

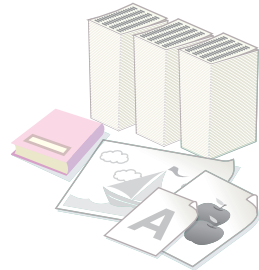

**Send this type of document**

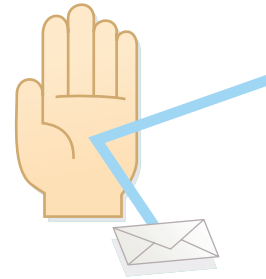

**Prevent transmission to the wrong destination**

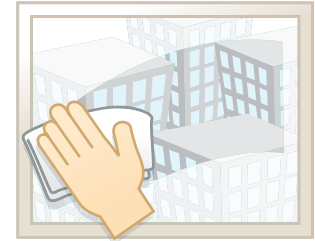

**Send a clear document**



**Save trouble**



**Security is important**



**Other convenient functions**

# Conserve



**Send when the rate is lowest**



**Check received data before printing**

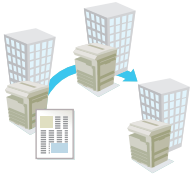

**Relay a transmission through a branch office**

# Send this type of document

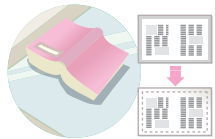

**Bulky original (shadows appear at edges)**



**More original pages than can be loaded at once**

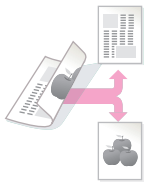

**Original printed on both sides**

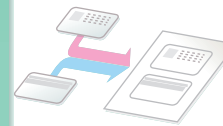

**ID card or other card**



# Prevent transmission to the wrong destination



**Check the destination once more before sending**



**Check the result of transmission**



**Check the log of previous transmissions**

# Send a clear document



**Adjust the exposure**



**Adjust the image quality**

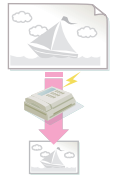

**Specify the size before sending**

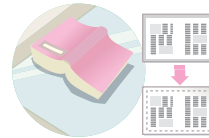

**Send without shadows at the edges**

# Save trouble

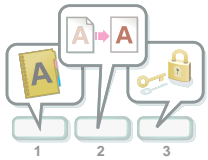

**Store frequently used settings**

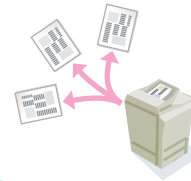

**Send to multiple destinations**

☎ XXXX-6789
➔ ☎ XXXX-9874
☎ XXXX-4567
☎ XXXX-5432
☎ XXXX-9999

**View the transmission log**

☎ XXXX-6789
☎ XXXX-9874
☎ XXXX-4567
➔ ☎ XXXX-5432
☎ XXXX-9999

**Easily specify an address (search number)**

# Security is important



**Check the destination once more before sending**



**Send confidentially**



**Print protected reception data**

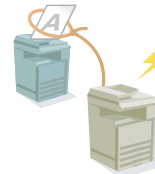

**Initiate reception of a document from a sending machine**

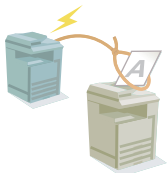

**Send a document at the other machine's request**



# Other convenient functions

## Convenient management functions

- Forward a received fax to a network address
- Print a list of addresses

## Convenient functions

- Send a thin original
- Select a transmission destination from a global address book
- Give priority to a transmission
- Use an extension phone
- Check the number of pages for the original then send

# SCAN AN IMAGE / SEND AN INTERNET FAX

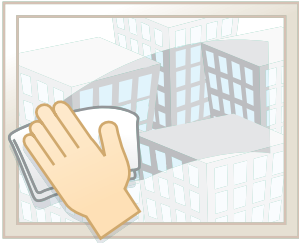

**Send a clear image**



**Send this type of document**

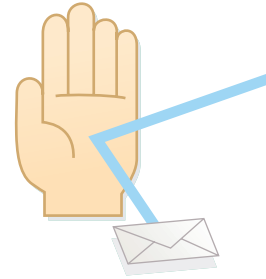

**Prevent transmission to the wrong destination**

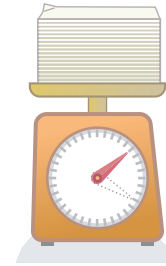

**Send a smaller file**



**Save trouble**

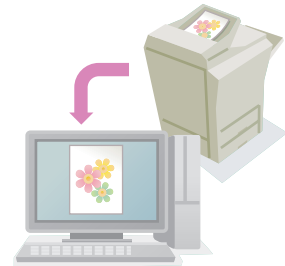

**Scan from my computer**



**Other convenient functions**

# Send a clear image

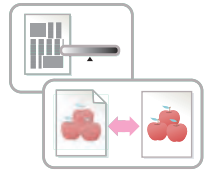

**Adjust the contrast or image quality**



**Adjust the resolution before sending**

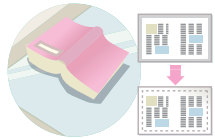

**Send without shadows at the edges**

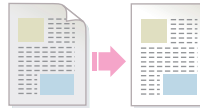

**Suppress the background of a transmitted document**

# Send this type of document

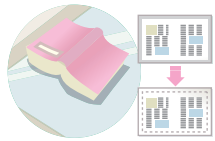

**Bulky original (shadows appear at edges)**

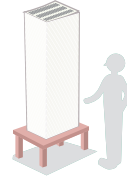

**More original pages than can be loaded at once**

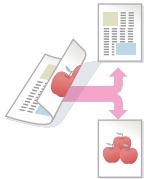

**Original printed on both sides**



**Original with background**



# Prevent transmission to the wrong destination



**Check the result of transmission**



**Check the log of previous transmissions**

# Send a smaller file



**Send at low resolution**

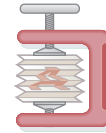

**Compress a file before sending**

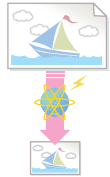

**Reduce an image before sending**

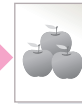

**Send an image in black & white**



**ID or other card**

# Save trouble

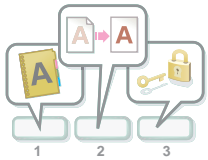

**Store frequently used settings**

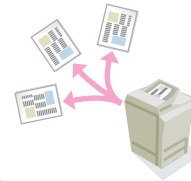

**Send to multiple destinations**



**View the transmission log**



**Easily specify an address (search number)**



**Send an Internet fax from a computer**



# Other convenient functions

## Convenient management functions

- Forward a received fax to a network address
- Print a list of transmission destinations

## Convenient functions

- Scan a thin original
- Select a transmission destination from a global address book
- Send at a specified time
- Give priority to a transmission
- Send in USB memory mode
- Original Sheets Before Transmisson
- Send the original while removing the colored portions
- Blank page skip

# SAVE A JOB AND REUSE IT LATER



**Search for a file**

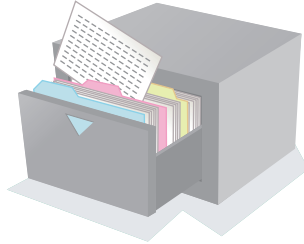

**Organize my files**

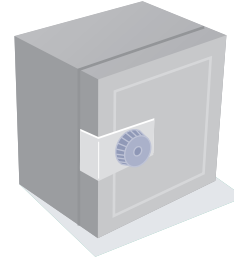

**Save an important document**

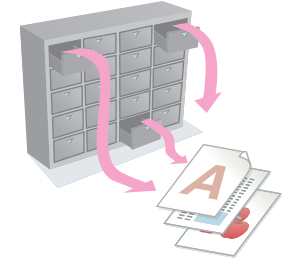

**Print a batch of files**

# Search for a file

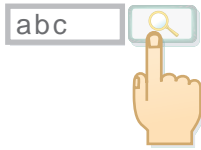

**Search for a file using a keyword**



**Search by checking the contents of files**

# Organize my files



**Delete a file**



**Delete all files**



**Periodically delete files**

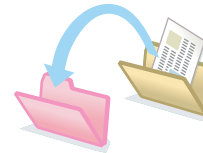

**Change the folder**

# MAINTAIN THE MACHINE



**Clean the machine**

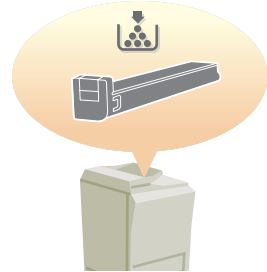

**Replace a toner cartridge**

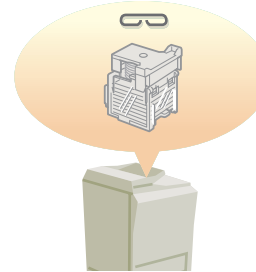

**Replace the staple cartridge**

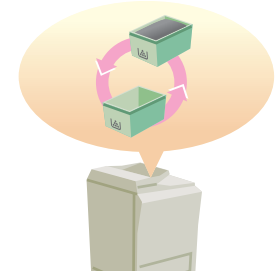

**Replace the toner collection container**



# Clean the machine



**Clean the document glass and automatic document feeder**

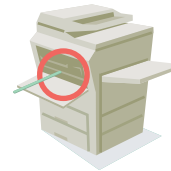

**Clean the main charger of the photoconductive drum**



**Clean the original feed roller**

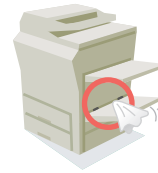

**Clean the bypass feed roller**

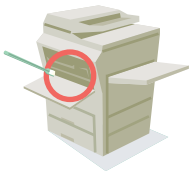

**Clean the laser unit**

# ABOUT OPERATION GUIDE

There are two ways to search for a topic in this guide: you can use an "I want to..." menu, or you can use a regular table of contents.

The following explanation assumes that Adobe Reader 8.0 is being used (Some buttons do not appear in the default state.).

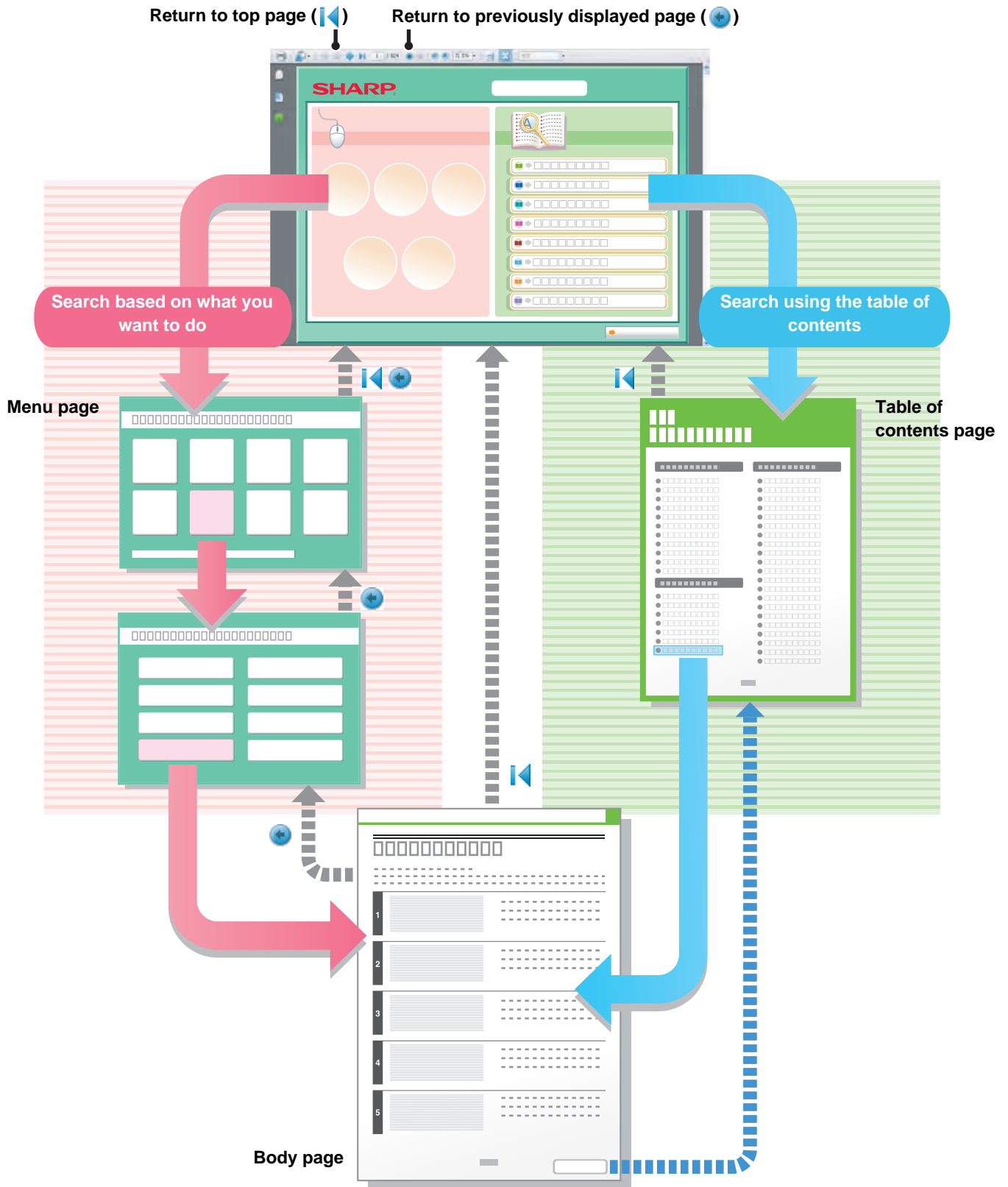

# HOW TO USE THIS MANUAL

Click a button below to move to the page that you wish to view.

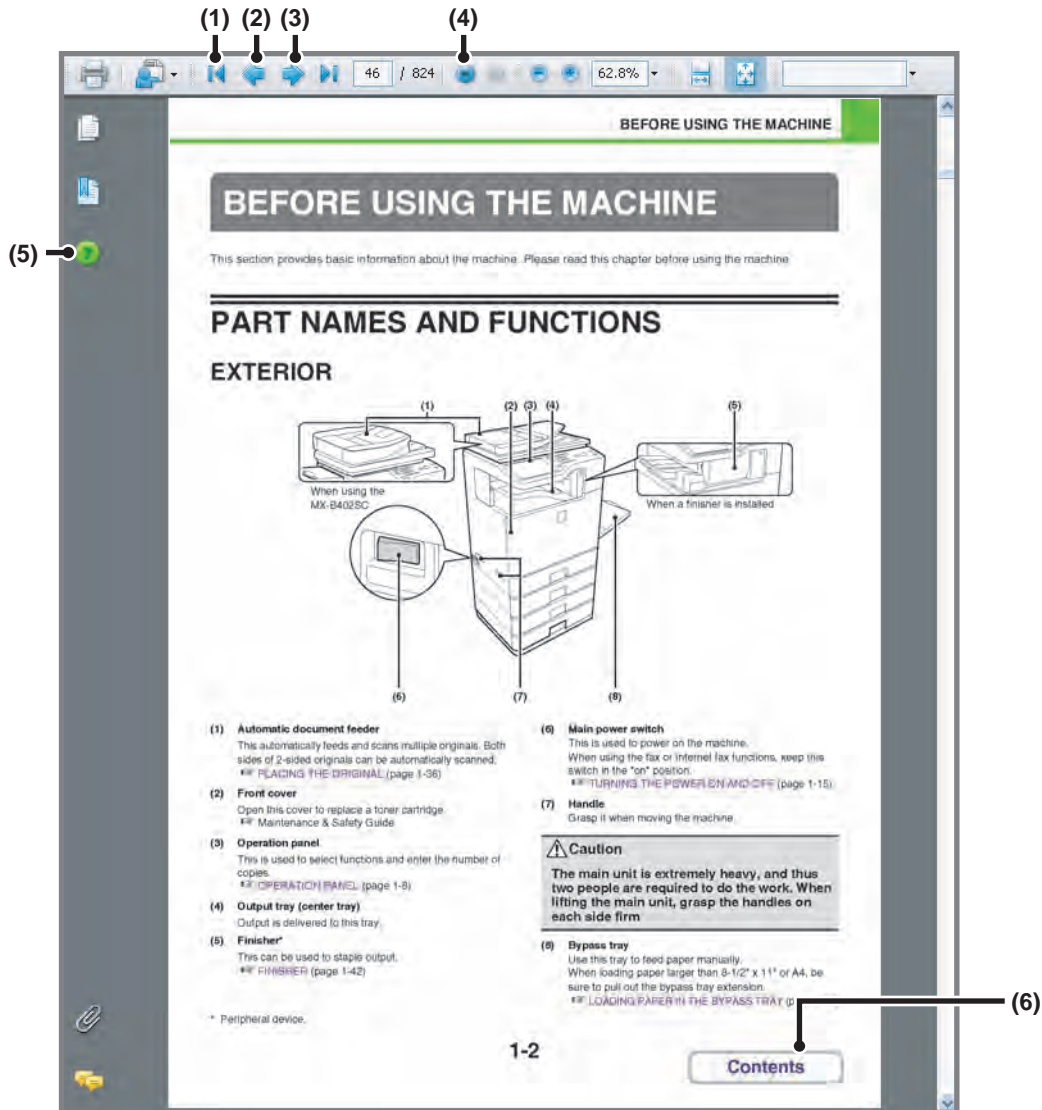

**(1) Return to top page button**

If an operation does not proceed as expected, click this button to start over again.

**(2) Back one page button**

Displays the previous page.

**(3) Forward one page button**

Displays the next page.

**(4) Return to previously displayed page button**

Displays the page that was displayed before the current page.

**(5) Adobe Reader Help button**

Opens Adobe Reader Help.

**(6) Contents button**

Displays the contents of each chapter.

For example, if the current page is a page in the body of the printer chapter, this button shows the contents of the printer chapter.



• If a button does not appear, refer to Adobe Reader Help to display the button.

**• Caution when printing**

If all pages are printed, the menu pages of the "I want to..." menu will also be printed. To print only the pages that contain the explanation of a function, specify a page range.

# MANUALS PROVIDED WITH THE MACHINE

## Operation manuals in PDF format (this manual)

The manuals in PDF format provide detailed explanations of the procedures for using the machine in each mode. To view the PDF manuals, download them from the hard drive in the machine. The procedure for downloading the manuals is explained in "Downloading the Operation Guide" in the Start Guide.



### 1. BEFORE USING THE MACHINE

This chapter provides information, such as basic operation procedures and how to load paper.



### 2. COPIER

This chapter provides detailed explanations of the procedures for using the copy function.



### 3. PRINTER

This chapter provides detailed explanations of the procedures for using the print function.



### 4. FACSIMILE

This chapter provides detailed explanations of the procedures for using the fax function.



### 5. SCANNER / INTERNET FAX

This chapter provides detailed explanations of the procedures for using the scanner function and the Internet fax function.



### 6. DOCUMENT FILING

This chapter provides detailed explanations of the procedures for using the document filing function. The document filing function allows you to save the document data of a copy or fax job, or the data of a print job, as a file on the machine's hard drive. The file can be called up as needed.



### 7. SYSTEM SETTINGS

This chapter explains the "System Settings", which are used to configure a variety of parameters to suit the aims and the needs of your workplace. Current settings can be displayed or printed out from the "System Settings".



### 8. TROUBLESHOOTING

This chapter explains how to remove paper misfeeds and provides answers to frequently asked questions regarding the operation of the machine in each mode. Refer to this manual when you have difficulty using the machine.

## Printed manuals

Manual name	Contents
Start Guide	This manual contains instructions for using the machine safely, describes preparations that must be made before using the machine, and lists the specifications of the machine and its peripheral devices.

# ABOUT OPERATION MANUAL

This manual explains how to use the MX-B402/MX-B402SC digital multifunctional system.

## Please note

- For information on installing the drivers and software cited in this manual, please refer to the Start Guide.
- For information on your operating system, please refer to your operating system manual or the online Help function.
- The explanations of screens and procedures in a Windows environment are primarily for Windows Vista®. The screens may vary depending on the version of the operating system or the software application.
- The explanations of screens and procedures in a Macintosh environment are based on Mac OS X v10.4 in the case of Mac OS X. The screens may vary depending on the version of the operating system or the software application.
- Wherever "MX-xxxx" appears in this manual, please substitute your model name for "xxxx".
- Considerable care has been taken in preparing this manual. If you have any comments or concerns about the manual, please contact your dealer or nearest SHARP Service Department.
- This product has undergone strict quality control and inspection procedures. In the unlikely event that a defect or other problem is discovered, please contact your dealer or nearest SHARP Service Department.
- Aside from instances provided for by law, SHARP is not responsible for failures occurring during the use of the product or its options, or failures due to incorrect operation of the product and its options, or other failures, or for any damage that occurs due to use of the product.

## Warning

- Reproduction, adaptation or translation of the contents of the manual without prior written permission is prohibited, except as allowed under copyright laws.
- All information in this manual is subject to change without notice.



## Illustrations and the operation panel and touch panel shown in this manual





The peripheral devices are generally optional, however, some models include certain peripheral devices as standard equipment. The explanations in this manual assume that 500 sheet paper feed units (total of four trays) are installed on the MX-B402. For some functions and procedures, the explanations assume that devices other than the above are installed.

The display screens, messages, and key names shown in the manual may differ from those on the actual machine due to product improvements and modifications.

## Icons used in the manuals

The icons in the manuals indicate the following types of information:

 <b>Warning</b>	This alerts you to a situation where there is a risk of human death or injury.
 <b>Caution</b>	This alerts you to a situation where there is a risk of human injury or property damage.

	This alerts you to a situation where there is a risk of machine damage or failure.		This indicates the name of a system setting and provides a brief explanation of the setting. <b>When "System Settings:" appears:</b> A general setting is explained. <b>When "System Settings (Administrator):" appears:</b> A setting that can only be configured by an administrator is explained.
	This provides a supplemental explanation of a function or procedure.		
	This explains how to cancel or correct an operation.		

# CHAPTER 1

# BEFORE USING THE MACHINE

This chapter provides information on basic operation procedures, how to load paper and machine maintenance.

## BEFORE USING THE MACHINE

<b>PART NAMES AND FUNCTIONS</b> .....	<b>1-3</b>
• EXTERIOR .....	1-3
• INTERIOR .....	1-5
• AUTOMATIC DOCUMENT FEEDER AND DOCUMENT GLASS .....	1-6
• SIDE AND BACK .....	1-7
• OPERATION PANEL .....	1-8
<b>TOUCH PANEL</b> .....	<b>1-10</b>
• STATUS DISPLAY .....	1-12
• SYSTEM BAR .....	1-13
<b>TURNING THE POWER ON AND OFF</b> .....	<b>1-15</b>
• ENERGY SAVE FUNCTIONS .....	1-16
• [POWER SAVE] KEY .....	1-16
<b>USER AUTHENTICATION</b> .....	<b>1-17</b>
• AUTHENTICATION BY USER NUMBER .....	1-17
• AUTHENTICATION BY LOGIN NAME / PASSWORD .....	1-19
<b>HOME SCREEN</b> .....	<b>1-22</b>
<b>REMOTE OPERATION OF THE MACHINE</b> .....	<b>1-23</b>
<b>ITEMS RECORDED IN THE JOB LOG</b> .....	<b>1-24</b>

## LOADING PAPER

<b>IMPORTANT POINTS ABOUT PAPER</b> .....	<b>1-27</b>
• NAMES AND LOCATIONS OF TRAYS .....	1-27
• USEABLE PAPER .....	1-27
<b>TRAY SETTINGS FOR TRAY 1 TO 4</b> .....	<b>1-30</b>
• LOADING PAPER AND CHANGING THE PAPER SIZE .....	1-30
<b>500-SHEET PAPER FEED UNIT SPECIFICATIONS</b> .....	<b>1-32</b>
<b>LOADING PAPER IN THE BYPASS TRAY</b> .....	<b>1-33</b>
• IMPORTANT POINTS WHEN USING THE BYPASS TRAY .....	1-34

## ORIGINALS

<b>PLACING THE ORIGINAL</b> .....	<b>1-37</b>
• PLACING ORIGINALS IN THE AUTOMATIC DOCUMENT FEEDER .....	1-37

• PLACING THE ORIGINAL ON THE DOCUMENT GLASS .....	1-41
--	------

## PERIPHERAL DEVICES

<b>PERIPHERAL DEVICES</b> .....	<b>1-43</b>
<b>FINISHER</b> .....	<b>1-45</b>
• PART NAMES .....	1-45
• SUPPLIES .....	1-45
<b>FINISHER SPECIFICATIONS</b> .....	<b>1-46</b>
<b>BUSINESS CARD FEEDER</b> .....	<b>1-47</b>
• Business card feeder specifications .....	1-48
<b>SHARP OSA</b> .....	<b>1-49</b>
• APPLICATION COMMUNICATION MODULE (MX-AMX2) .....	1-49
• EXTERNAL ACCOUNT MODULE (MX-AMX3) .....	1-50

## REPLACING SUPPLIES AND MAINTENANCE

<b>REPLACING THE TONER CARTRIDGES</b> .....	<b>1-52</b>
<b>REPLACING THE TONER COLLECTION CONTAINER</b> .....	<b>1-55</b>
<b>REPLACING THE STAPLE CARTRIDGE IN THE FINISHER</b> .....	<b>1-58</b>
<b>REGULAR MAINTENANCE</b> .....	<b>1-60</b>
<b>CLEANING THE DOCUMENT GLASS AND AUTOMATIC DOCUMENT FEEDER</b> .....	<b>1-61</b>
<b>CLEANING THE MAIN CHARGER OF THE PHOTOCONDUCTIVE DRUM</b> .....	<b>1-62</b>
<b>CLEANING THE BYPASS TRAY ROLLERS</b> .....	<b>1-65</b>
<b>CLEANING THE AUTOMATIC DOCUMENT FEEDER ROLLERS</b> .....	<b>1-67</b>
<b>CLEANING THE LASER UNIT</b> .....	<b>1-70</b>
<b>CLEANING THE PT CHARGER OF THE PRIMARY TRANSFER BELT UNIT</b> .....	<b>1-74</b>



**ENTERING TEXT**

<b>FUNCTIONS OF THE MAIN KEYS</b> .....	<b>1-76</b>
• ENTERING TEXT FROM A KEYBOARD.....	1-78

**SOFTWARE SETUP**

<b>BEFORE INSTALLING THE SOFTWARE</b> .....	<b>1-79</b>
<b>SETUP IN A WINDOWS ENVIRONMENT</b> .....	<b>1-80</b>
• OPENING THE SOFTWARE SELECTION SCREEN (FOR ALL SOFTWARE).....	1-80
• INSTALLING THE PRINTER DRIVER / PC-FAX DRIVER .....	1-81
• INSTALLING THE PRINTER STATUS MONITOR...	1-100
• INSTALLING THE SCANNER DRIVER.....	1-101
• CHANGING THE PORT.....	1-103
<b>SETUP IN A MACINTOSH ENVIRONMENT</b> ....	<b>1-107</b>
• MAC OS X .....	1-107
• MAC OS 9.0 - 9.2.2 .....	1-113
<b>REMOVING THE SOFTWARE</b> .....	<b>1-116</b>

# BEFORE USING THE MACHINE

This section provides basic information about the machine. Please read this chapter before using the machine.

## PART NAMES AND FUNCTIONS

### EXTERIOR

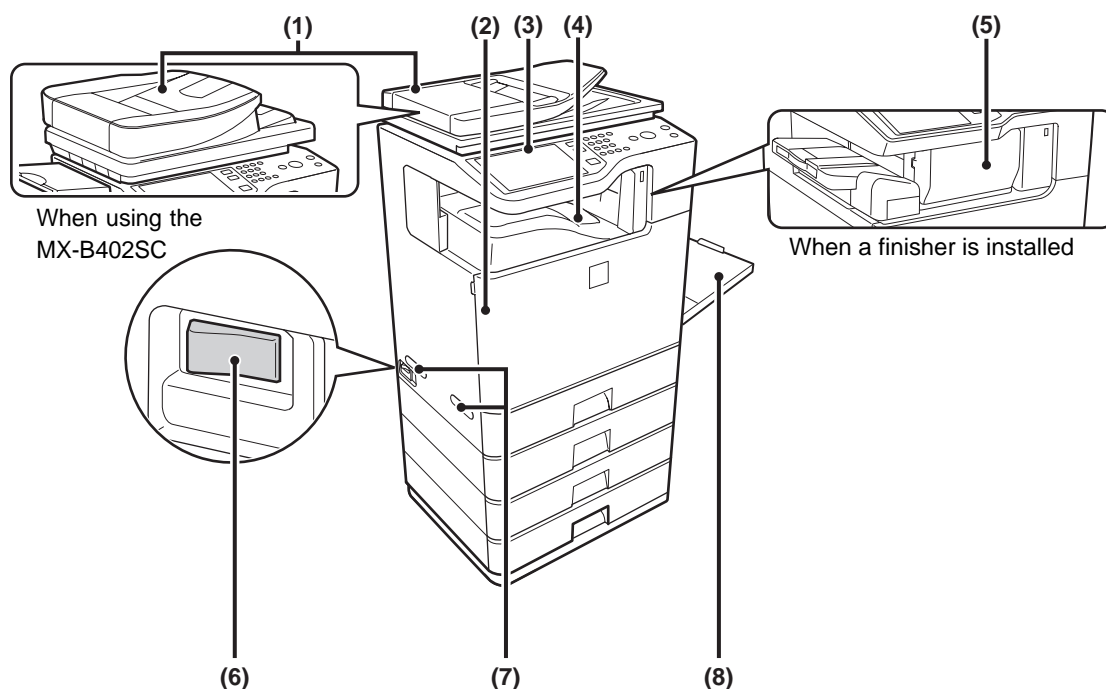

**(1) Automatic document feeder**

This automatically feeds and scans multiple originals. Both sides of 2-sided originals can be automatically scanned.

➤ [PLACING THE ORIGINAL](#) (page 1-37)

**(2) Front cover**

Open this cover to replace a toner cartridge.

➤ [REPLACING SUPPLIES AND MAINTENANCE](#) (page 1-52)

**(3) Operation panel**

This is used to select functions and enter the number of copies.

➤ [OPERATION PANEL](#) (page 1-8)

**(4) Output tray (center tray)**

Output is delivered to this tray.

**(5) Finisher\***

This can be used to staple output.

➤ [FINISHER](#) (page 1-45)

**(6) Main power switch**

This is used to power on the machine.

When using the fax or Internet fax functions, keep this switch in the "on" position.

➤ [TURNING THE POWER ON AND OFF](#) (page 1-15)

**(7) Handle**

Grasp it when moving the machine.

**! Caution**

**The main unit is extremely heavy, and thus two people are required to do the work. When lifting the main unit, grasp the handles on each side firm**

**(8) Bypass tray**

Use this tray to feed paper manually.

When loading paper larger than 8-1/2" x 11" or A4, be sure to pull out the bypass tray extension.

➤ [LOADING PAPER IN THE BYPASS TRAY](#) (page 1-33)

\* Peripheral device.

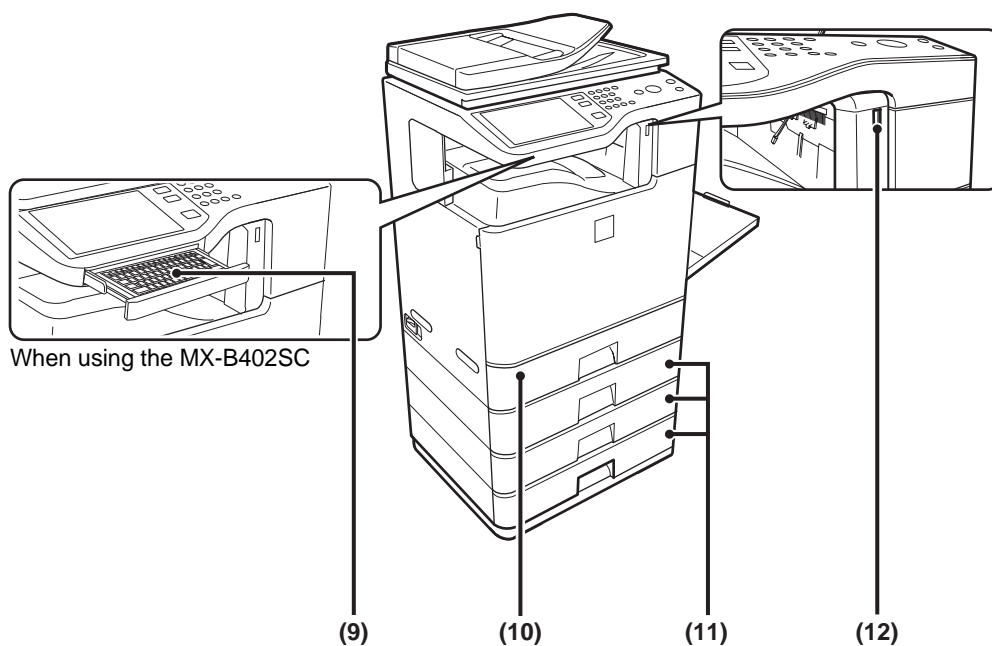

**(9) Keyboard (MX-B402SC only)**

This is a keyboard that is incorporated into the machine. When not used, it can be stored under the operation panel.

☞ [ENTERING TEXT FROM A KEYBOARD](#) (page 1-78)

**(10) Tray 1**

This holds paper.

☞ [TRAY SETTINGS FOR TRAY 1 TO 4](#) (page 1-30)

**(11) Tray 2/Tray 3/Tray 4**

**(When 500-sheet paper feed units are installed)\***

These hold paper.

For 500-sheet paper feed unit combinations, consult your dealer or nearest SHARP Service Department.

☞ [TRAY SETTINGS FOR TRAY 1 TO 4](#) (page 1-30)

**(12) USB connector (A type)**

Supports USB 2.0 (Hi-Speed).

This is used to connect a USB device such as USB memory to the machine.

For the USB cable, use a shielded cable.

\* Peripheral device.

# INTERIOR

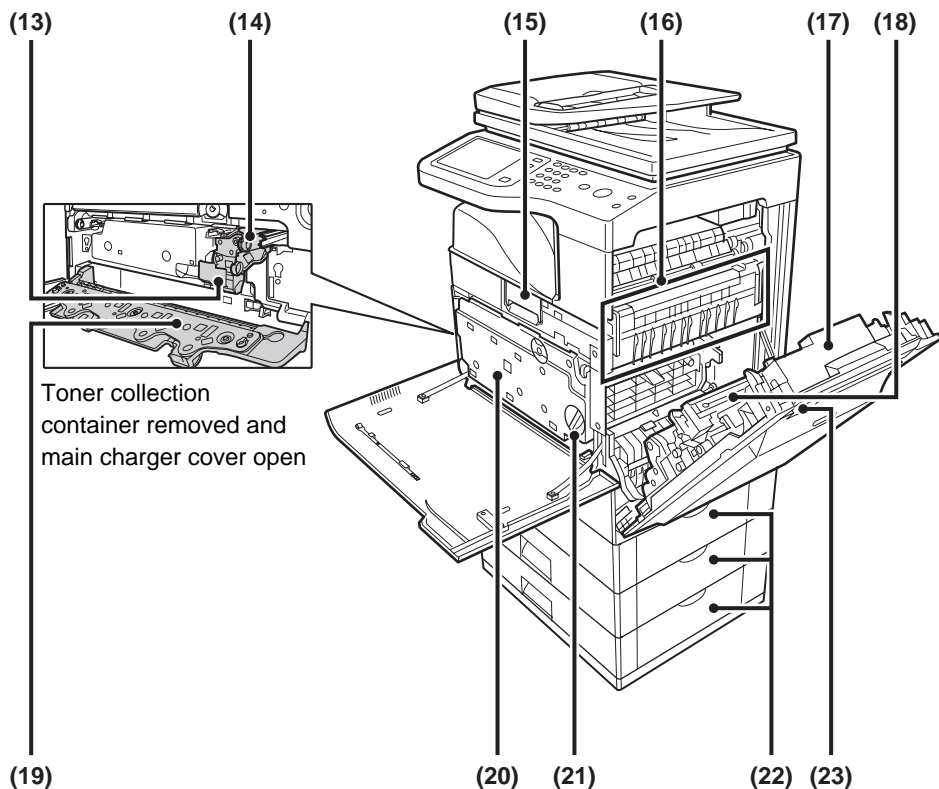

## (13) Developer cartridge

This contains the developer that is necessary to transfer the toner to the paper.

When replacing the drum cartridge, the developer cartridge must be removed before the drum cartridge is replaced.

➤ [REPLACING SUPPLIES AND MAINTENANCE](#) (page 1-52)

## (14) Drum cartridge

This contains the photosensitive drum that is used to create images for copying and printing.

➤ [REPLACING SUPPLIES AND MAINTENANCE](#) (page 1-52)

## (15) Toner cartridge

This contains toner for printing. When the toner runs out in a cartridge, the cartridge must be replaced.

➤ [REPLACING SUPPLIES AND MAINTENANCE](#) (page 1-52)

## (16) Fusing unit

Heat is applied here to fuse the transferred image onto the paper.



### Caution

**The fusing unit is hot. Take care not to burn yourself when removing a paper misfeed.**

## (17) Right side cover

Open this cover to remove a misfeed.

➤ 8. TROUBLESHOOTING "REMOVING MISFEEDS" (page 8-10)

## (18) Paper reversing section

This is used when 2-sided printing is performed. Open this part to remove a paper misfeed.

➤ [REPLACING SUPPLIES AND MAINTENANCE](#) (page 1-52)

## (19) Main charger cover

Open this cover to clean the main charger.

➤ [REPLACING SUPPLIES AND MAINTENANCE](#) (page 1-52)

## (20) Toner collection container

This collects excess toner that remains after printing.

➤ [REPLACING SUPPLIES AND MAINTENANCE](#) (page 1-52)



Your service technician will collect the toner collection container.

## (21) Toner collection container release lever

Turn this lever when you need to release the toner collection container lock to replace the toner collection container or clean the laser unit.

➤ [REPLACING SUPPLIES AND MAINTENANCE](#) (page 1-52)

## (22) Paper tray right side cover

Open this to remove a paper misfeed in trays.

➤ 8. TROUBLESHOOTING "REMOVING MISFEEDS" (page 8-10)

## (23) Right side cover release lever

To remove a paper misfeed, pull and hold this lever up to open the right side cover.

➤ 8. TROUBLESHOOTING "REMOVING MISFEEDS" (page 8-10)

# AUTOMATIC DOCUMENT FEEDER AND DOCUMENT GLASS

## Automatic document feeder (MX-B402)

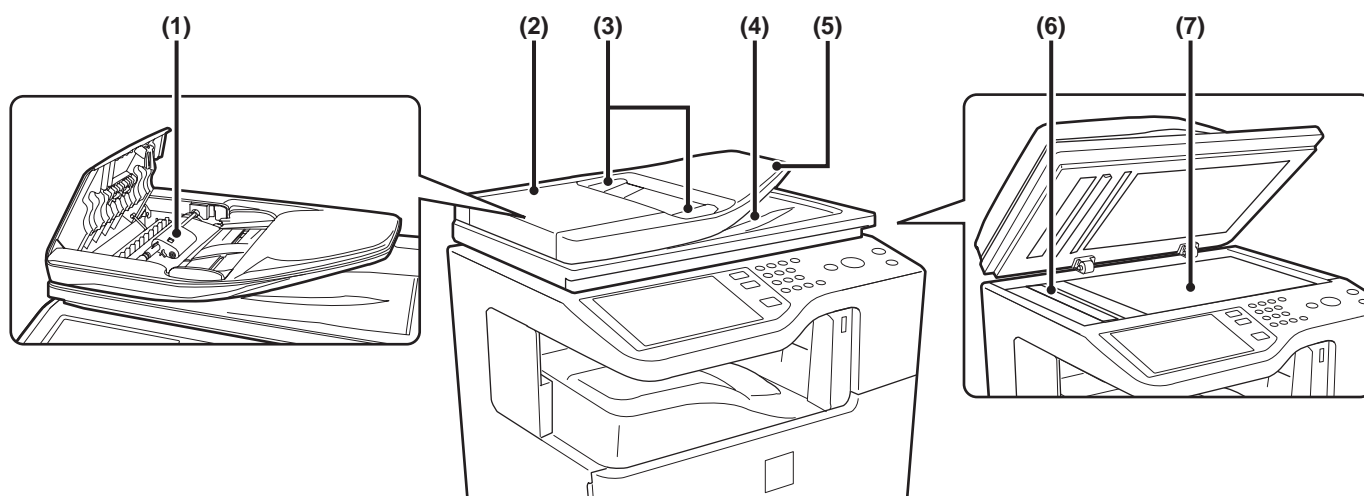

## Automatic document feeder (MX-B402SC)

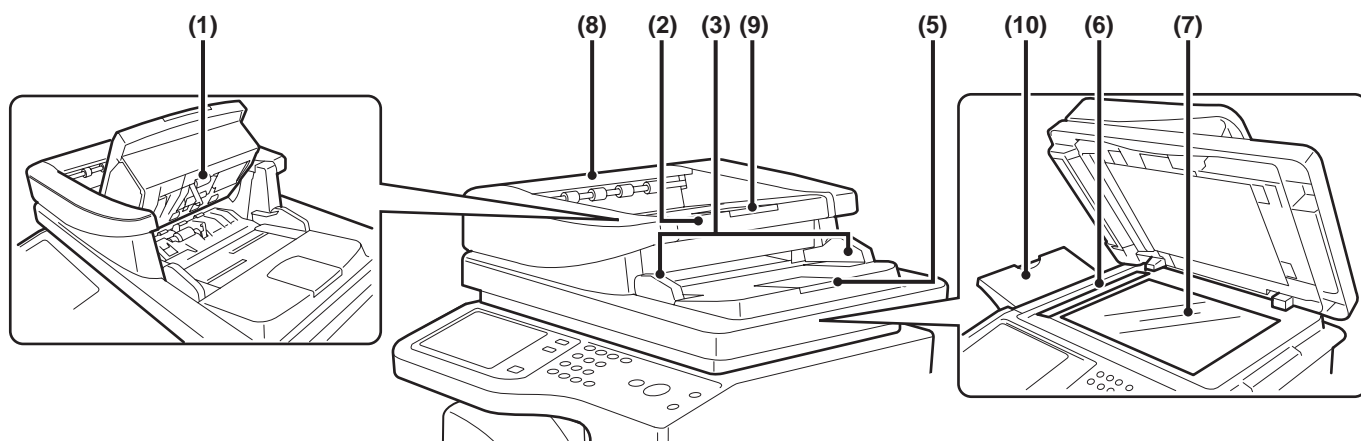

**(1) Paper feed roller**

This roller rotates to automatically feed the original.

**(2) Document feeding area cover**

Open this cover to remove an original misfeed or clean the paper feed roller.

➤ 8. TROUBLESHOOTING "REMOVING MISFEEDS" (page 8-10)

**(3) Original guides**

These help ensure that the original is scanned correctly. Adjust the guides to the width of the original.

➤ PLACING THE ORIGINAL (page 1-37)

**(4) Original exit tray**

Originals are delivered to this tray after scanning.

**(5) Document feeder tray**

Place originals in this tray. 1-sided originals must be placed face up.

➤ PLACING THE ORIGINAL (page 1-37)

**(6) Scanning area**

Originals placed in the document feeder tray are scanned here.

**(7) Document glass**

Use this to scan a book or other thick original that cannot be fed through the automatic document feeder.

➤ PLACING THE ORIGINAL ON THE DOCUMENT GLASS (page 1-41)

**(8) Document exit area cover**

open this cover to remove an original misfeed.

**(9) Original exit tray 1**

Originals are delivered to this tray after scanning.

**(10) Original exit tray 2**

If originals are not delivered to original exit tray 1 after scanning, they are delivered to this tray.

## SIDE AND BACK

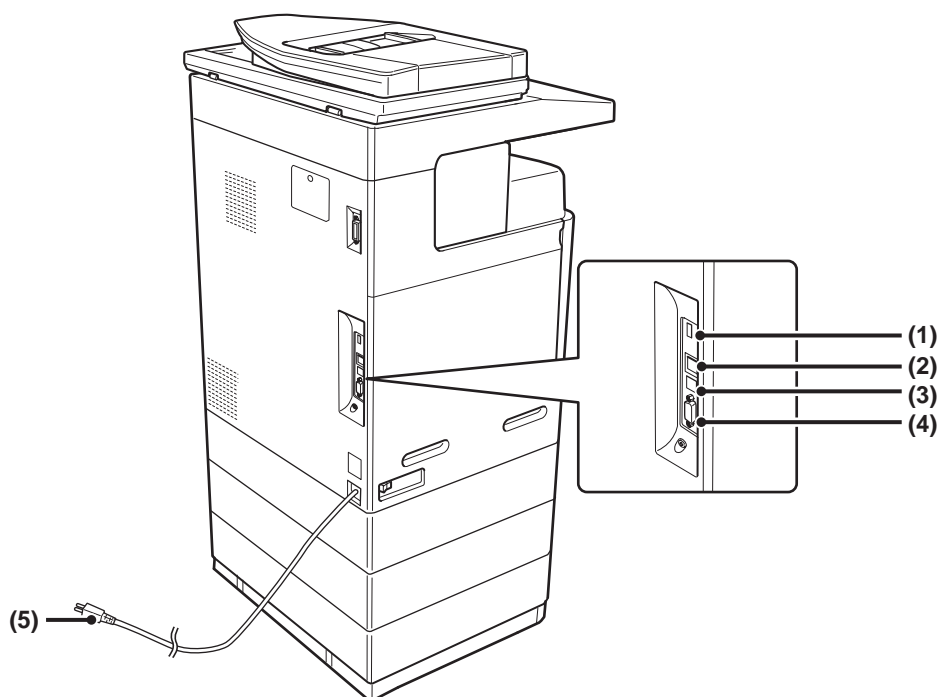

**(1) USB connector (A type)**

Supports USB 2.0 (Hi-Speed).

This is used to connect a USB device such as USB memory to the machine.

For the MX-B402, this connector is not initially available for use. If you wish to use the connector, contact your service technician.

**(2) LAN connector**

Connect the LAN cable to this connector when the machine is used on a network.

For the LAN cable, use a shielded type cable.

**(3) USB connector (B type)**

Supports USB 2.0 (Hi-Speed).

A computer can be connected to this connector to use the machine as a printer.

For the USB cable, use a shielded cable.

**(4) Service-only connector**

**⚠ Caution**

**This connector is for use only by service technicians.**

**Connecting a cable to this connector may cause the machine to malfunction.**

**Important note for service technicians:  
The cable connected to the service connector must be less than 118" (3 m) in length.**

**(5) Power plug**

# OPERATION PANEL

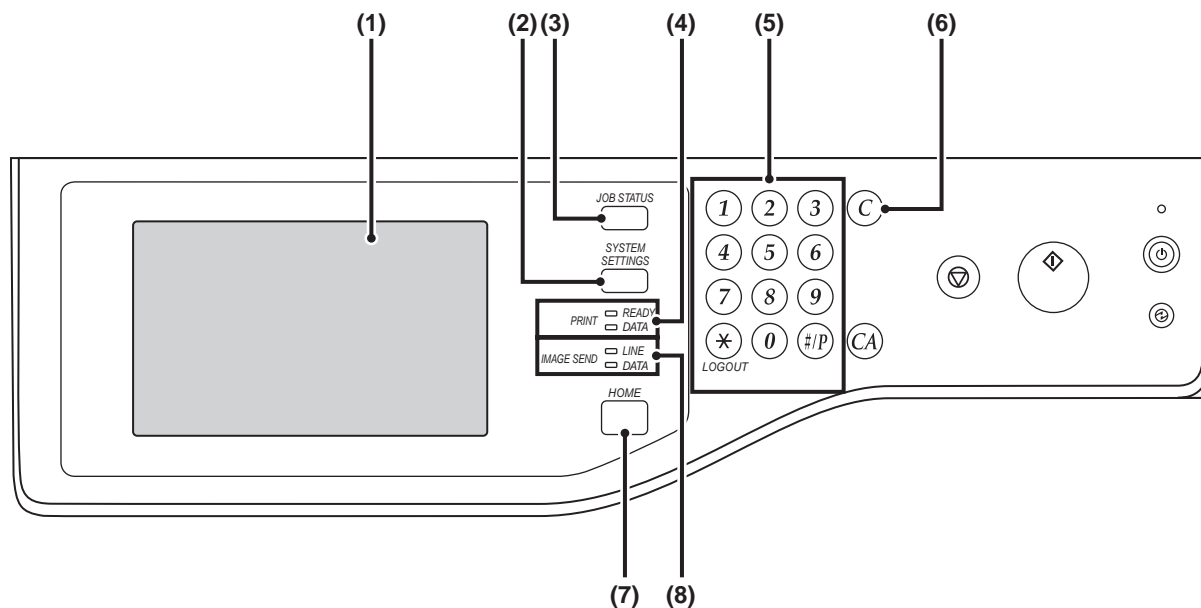

## (1) Touch panel

Messages and keys appear in the touch panel display. Touch the displayed keys to perform a variety of operations. When a key is touched, a beep sounds and the selected item is highlighted. This provides confirmation as you perform an operation.

➤ [TOUCH PANEL](#) (page 1-10)

## (2) [SYSTEM SETTINGS] key

Press this key to display the system settings menu screen. The system settings are used to configure paper tray settings, store addresses for transmission operations, and adjust parameters to make the machine easier to use.

## (3) [JOB STATUS] key

Press this key to display the job status screen. The job status screen is used to check information on jobs and to cancel jobs.

For details, see the chapters for each of the functions in this manual.

## (4) PRINT mode indicators

### • READY indicator

Print jobs can be received when this indicator is lit.

### • DATA indicator

This blinks while print data is being received and lights steadily while printing is taking place.

## (5) Numeric keys

These are used to enter the number of copies, fax numbers, and other numerical values. These keys are also used to enter numeric value settings (except for the system settings).

## (6) [CLEAR] key (C)

Press this key to return the number of copies to "0".

## (7) [HOME] key

Touch this key to display the home screen. Frequently used settings can be registered in the home screen to enable quick and easy operation of the machine.

➤ [HOME SCREEN](#) (page 1-22)

## (8) IMAGE SEND mode indicators

### • LINE indicator

This lights up during transmission or reception of a fax or Internet fax. This also lights during transmission of an image in scan mode.

### • DATA indicator

This blinks when a received fax or Internet fax cannot be printed because of a problem such as out of paper. This lights up when there is a transmission job that has not been sent.

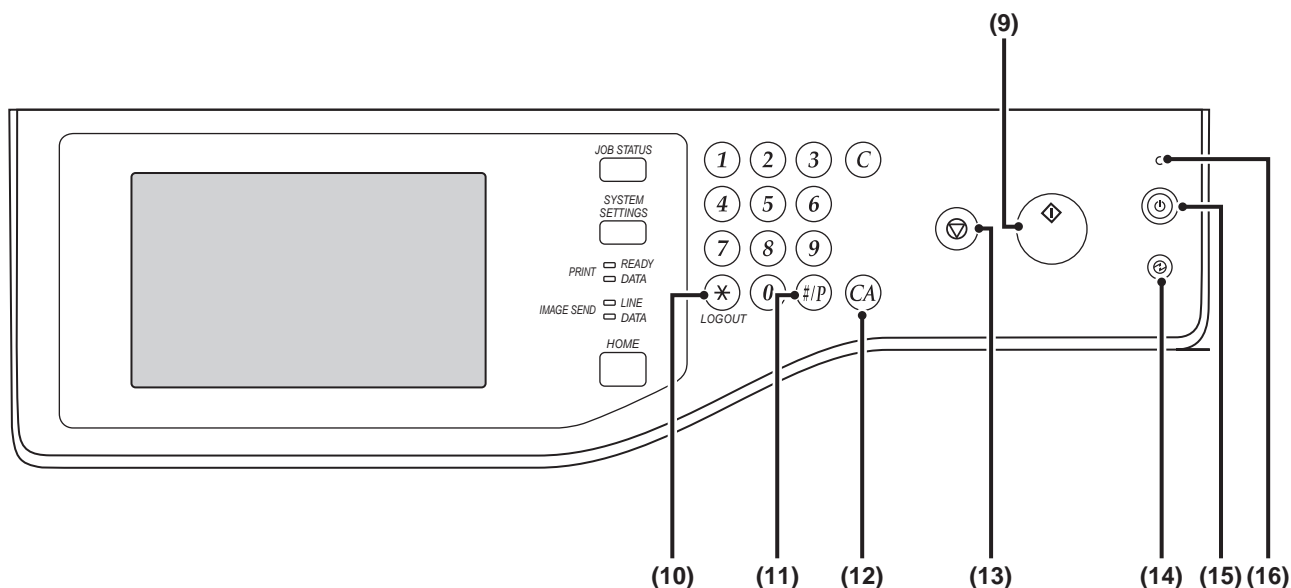
**(9) [START] key**

Press this key to copy or scan an original.  
This key is also used to send a fax in fax mode.

**(10) [LOGOUT] key**

Press this key to log out after you have logged in and used the machine. When using the fax function, this key can also be pressed to send tone signals on a pulse dial line.

➤ [USER AUTHENTICATION](#) (page 1-17)

**(11) [#/P] key**

When using the copy function, press this key to use a job program. When using the fax function, this key can be used when dialing.

**(12) [CLEAR ALL] key**

Press this key to return to the initial operation state.  
Use this key when you wish to cancel all settings that have been selected and start operation from the initial state.

**(13) [STOP] key**

Press this key to stop a copy job or scanning of an original.

**(14) [POWER SAVE] key / indicator**

Use this key to put the machine into auto power shut-off mode to save energy.

The [POWER SAVE] key blinks when the machine is in auto power shut-off mode.

➤ [\[POWER SAVE\] KEY](#) (page 1-16)

**(15) [POWER] key**

Use this key to turn the machine power on and off.

➤ [TURNING THE POWER ON AND OFF](#) (page 1-15)

**(16) Main power indicator**

This lights up when the machine's main power switch is in the "on" position.

➤ [TURNING THE POWER ON AND OFF](#) (page 1-15)

# TOUCH PANEL

This section explains how to use the touch panel.

- To enter text, see "ENTERING TEXT" (page 1-76).
- For information on the screens and procedures for using the system settings, see "Common Operation Methods" (page 7-4) in "7. SYSTEM SETTINGS".

## Using the touch panel

### Example 1

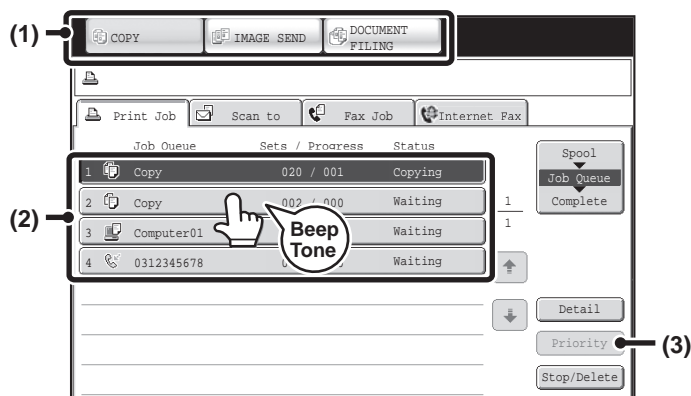

#### (1) Mode select keys

Use these keys to switch between copy, image send, and document filing modes.

#### (2) Settings for each function are easily selected and canceled by touching the keys on the screen with your finger.

When an item is selected, a beep will sound and the item will be highlighted to confirm the selection.

#### (3) Keys that are grayed out cannot be selected.



If you touch a key that cannot be selected, a double beep will sound.

### Example 2

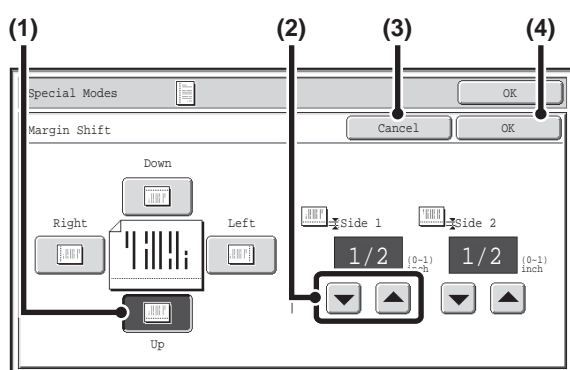

(1) If the initial state of a key in a screen is highlighted, the key is selected. To change the selection, touch one of the other keys to highlight that key.

(2) The keys can be used to increase or decrease a value. To make a value change quickly, keep your finger on the key.

(3) Touch this key to cancel a setting.

(4) Touch the [OK] key to enter and save a setting.

### Example 3

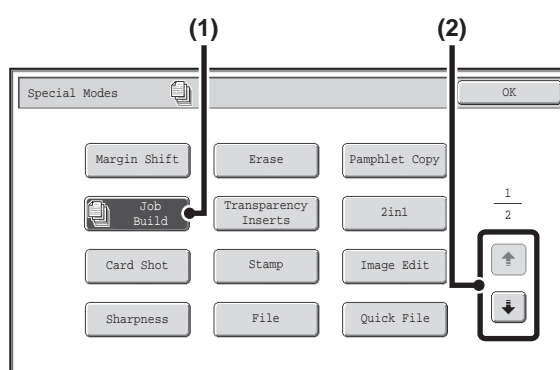



(1) Some items in the special modes screen are selected by simply touching the key of the item.

To cancel a selected item, touch the highlighted key once again so that it is no longer highlighted.

(2) When settings extend over multiple screens, touch the key or the key to switch through the screens.

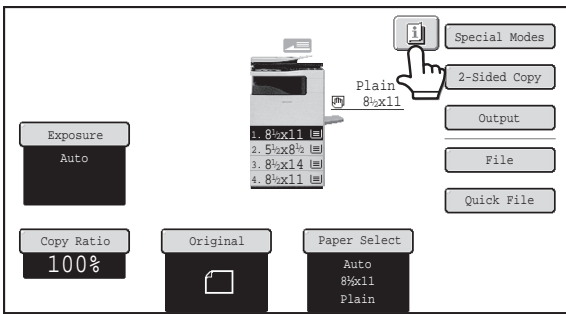
Example 4



When at least one special mode is selected, the  key appears in the base screen.

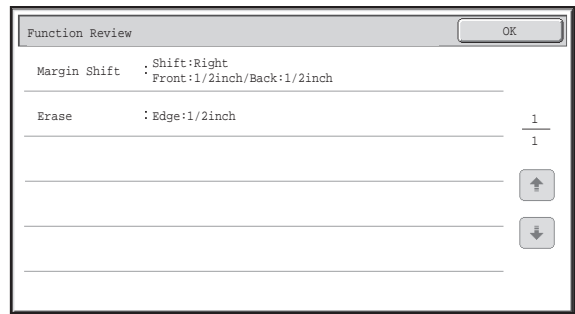

The  key can be touched to display a list of the selected special modes.

Example 5

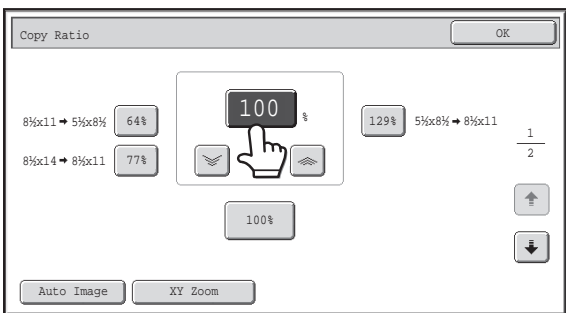

Touch a numeric value display key to directly enter a value with the numeric keys.

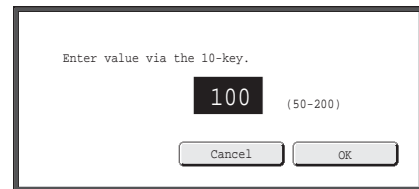

Press the numeric keys to enter any numeric value and then touch the [OK] key.

 The touch panel (screen) shown in this manual is a descriptive image. The actual screen is slightly different.

 **System Settings (Administrator): Keys Touch Sound**  
This is used to adjust the volume of the beep that sounds when keys are touched. The key touch sound can also be turned off.



# STATUS DISPLAY

When the base screen of a mode appears, the right side of the touch panel shows the machine's status. The information shown is explained below.

## Example: Basic screen of copy mode

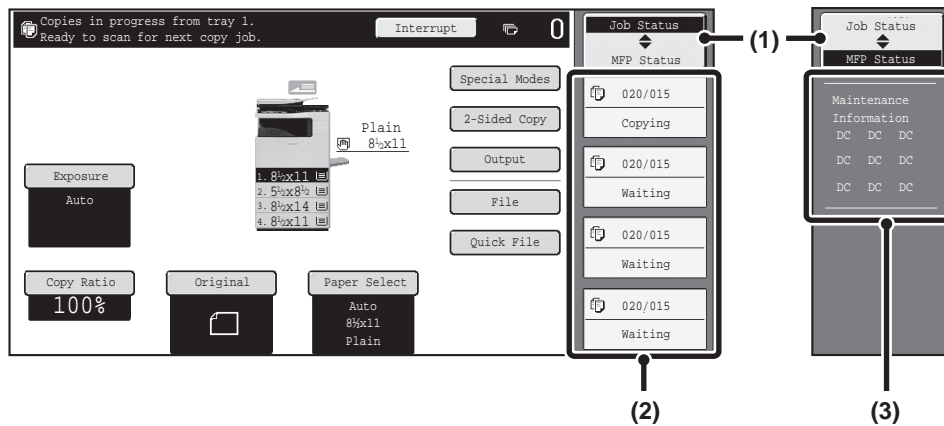

### (1) Display selection key

The status display can be switched between "Job Status" and "MFP Status".

If the job status screen is displayed, the status display automatically changes to "MFP Status".

### (2) "Job Status" display

This shows the first 4 print jobs in the print queue (the job in progress and jobs waiting to be printed). The type of job, the set number of copies, the number of copies completed, and the job status appear.

Jobs cannot be manipulated in this screen. Jobs can only be manipulated in the job status screen.

For details, see the chapters for each of the functions in this manual.

### (3) "MFP Status" display

This shows machine system information. "Maintenance Information"

This shows machine maintenance information by means of codes.

# SYSTEM BAR

The system bar appears at the bottom of the touch panel.  
The items that appear in the system bar are explained below.

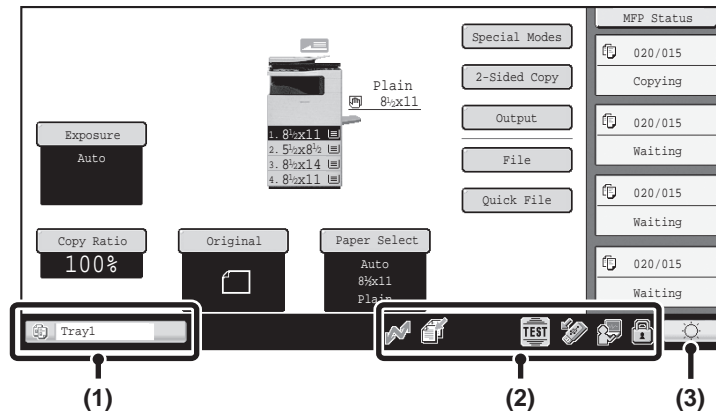

## (1) Job status display

The jobs in progress or reserved are indicated by icons. The icons are as follows.

	Print job		Copy job
	Scan to E-mail job		Scan to FTP job
	Scan to Network Folder job		Scan to Desktop job
	Fax transmission job		Fax reception job
	PC-Fax transmission job		Internet fax transmission job (Including Direct SMTP)
	Internet Fax reception job (Including Direct SMTP)		PC-I-Fax transmission job
	Broadcast job* Inbound routing job		Scan to HDD file print job
	Metadata send job		

\* This appears in a multi-mode broadcast job.



When a base screen other than that of image send mode appears, the number of the tray being used to feed paper appears during paper feeding. The color appearing in the job status display depends on the job status as indicated in the table below.

The job status display can be touched to show the job status screen.

Job status display	Machine Configuration
Green	A print, scan or other job is being executed normally.
Yellow	The machine is warming up or on standby, or a job is being canceled.
Red	A paper misfeed or other error condition has occurred.
Gray	The machine has no jobs.

## (2) Icon display

	This icon appears when data is being sent or received.
	This icon appears when fax, scan, or Internet fax data is stored in the machine's memory. When data to be transmitted is stored,  appears. When received data is stored,  appears. When both data to be transmitted and received data are stored,  appears.
	This icon appears when a service technician has activated simulation mode.
	This icon appears when a USB memory or other USB device is connected to the machine.

	This icon appears when the data security kit is being used.
	The icon appears when the machine is communicating with an external application.

**(3) Brightness adjustment key**

Touch this key to adjust the brightness of the touch panel.

When touched, the following screen appears next to the key.



Touch the [+] key or the [-] key to adjust the brightness.

When finished, touch the brightness adjustment key again to close the screen.

# TURNING THE POWER ON AND OFF

The machine has two power switches. One is the main power switch on the left side of the machine, and the other is the [POWER] key (⏻) on the upper right side of the operation panel.

## Main power switch

When the main power switch is switched on, the main power indicator on the operation panel lights up.

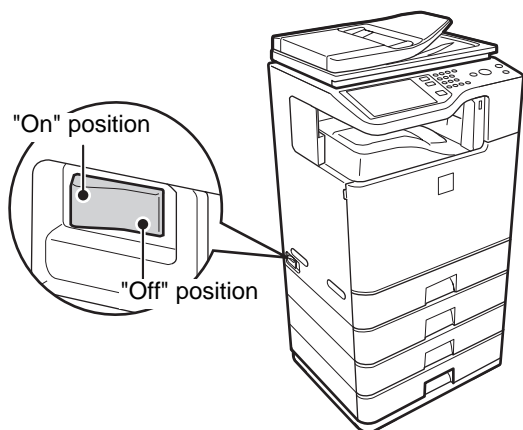

## [POWER] key

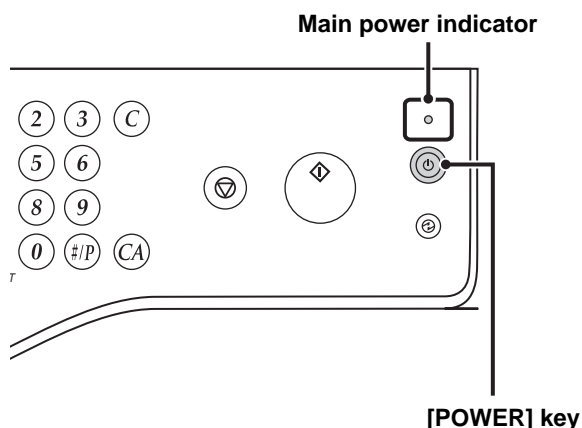

## Turning on the power

- (1) Switch the main power switch to the "on" position.
- (2) Press the [POWER] key (⏻) to turn on the power.

## Turning off the power

- (1) Press the [POWER] key (⏻) to turn off the power.
- (2) Switch the main power switch to the "off" position.

- ⚠ Before switching off the main power switch, make sure that the DATA indicator for printing and the DATA and LINE indicators for image send are not lit or blinking on the operation panel. Switching off the main power switch or removing the power cord from the outlet while any of the indicators are lit or blinking may damage the hard drive and cause data to be lost.
- Switch off both the [POWER] key (⏻) and the main power switch and unplug the power cord if you suspect a machine failure, if there is a bad thunderstorm nearby, or when you are moving the machine.

- ✎ When using the fax or Internet fax function, always keep the main power switch in the "on" position.

## Restarting the machine

In order for some settings to take effect, the machine must be restarted.

If a message in the touch panel prompts you to restart the machine, press the [POWER] key (⏻) to turn off the power and then press the key again to turn the power back on.

- ✎ In some states of the machine, pressing the [POWER] key (⏻) to restart will not make the settings take effect. In this case, use the main power switch to switch the power off and then on.

## ENERGY SAVE FUNCTIONS

This product has the following two energy save functions that conform to the Energy Star guidelines to help conserve natural resources and reduce environmental pollution.

### Preheat Mode (Low power mode)

Preheat mode automatically lowers the temperature of the fusing unit and thereby reduces power consumption if the machine remains in the standby state for the interval of time set in "Preheat Mode Setting" in the system settings (administrator).

This keeps the fusing unit at a lower temperature and reduces power consumption while the machine is on standby. The machine automatically wakes up and returns to normal operation when a print job is received, a key is pressed on the operation panel, or an original is placed.

### Auto power shut-off mode (Sleep mode)

Auto power shut-off mode automatically shuts off power to the display and the fusing unit if the machine remains in the standby state for the interval of time set in "Auto Power Shut-Off Timer" in the system settings (administrator). This mode provides the lowest level of power consumption. Considerably more power is saved than in preheat mode, however, the wakeup time is longer. This mode can be disabled in the system settings (administrator).

The machine automatically wakes up and resumes normal operation when a print job is received or when the blinking [POWER SAVE] key (Ⓢ) is pressed.

## [POWER SAVE] KEY

Press the [POWER SAVE] key (Ⓢ) to put the machine in auto power shut-off mode or wake it up from auto power shut-off mode. The [POWER SAVE] key (Ⓢ) has an indicator that indicates whether or not the machine is in auto power shut-off mode.

<b>When the [POWER SAVE] key (Ⓢ) indicator is off in the standby state</b>	The machine is ready to be used. If the [POWER SAVE] key (Ⓢ) is pressed when the indicator is off, the indicator will blink and the machine will enter auto power shut-off mode after a brief interval.
<b>When the [POWER SAVE] key (Ⓢ) indicator is blinking</b>	The machine is in auto power shut-off mode. If the [POWER SAVE] key (Ⓢ) is pressed when the indicator is blinking, the indicator will turn off and the machine will return to the ready state after a brief interval.

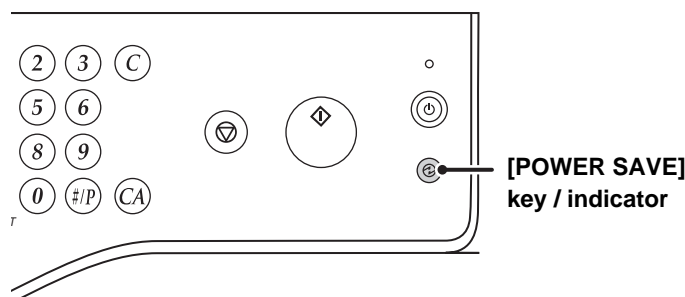

# USER AUTHENTICATION

User authentication restricts the use of the machine to users that have been registered. The functions that each user is allowed to use can be specified, allowing the machine to be customized to meet the needs of your workplace.

When the administrator of the machine has enabled user authentication, each user must log in to use the machine.

There are different types of user authentication, and each type has a different login method.

For more information, see the explanations of the login methods.

☞ [AUTHENTICATION BY USER NUMBER](#) (see below)

☞ [AUTHENTICATION BY LOGIN NAME / PASSWORD](#) (page 1-19)

## AUTHENTICATION BY USER NUMBER

The following procedure is used to log in using a user number received from the administrator of the machine.



When controlled by user number

1

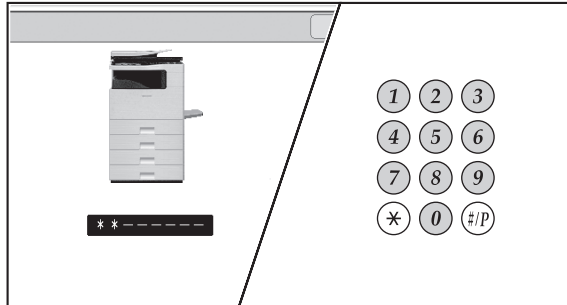

**Enter your user number (5 to 8 digits) with the numeric keys.**

Each entered digit will be displayed as "\*" .

2



### Touch the [OK] key.

After the entered user number is authenticated, the user count screen will appear briefly.

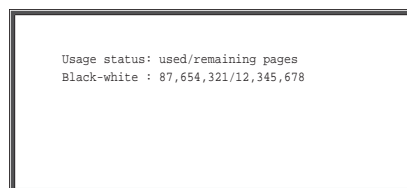

When page limits have been set in "Pages Limit Group List" in the system settings (administrator), the number of pages remaining will appear. (The remaining number of pages that the user can use in each mode (copy, scan, etc.) appears.) The amount of time that this screen appears can be changed using "Message Time Setting" in the system settings (administrator).



When the user number is an 8-digit number, this step is not necessary. (Login takes place automatically after the user number is entered.)

3

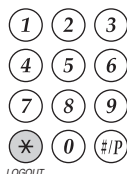

### When you have finished using the machine and are ready to log out, press the [LOGOUT] key (\*).



- However, note that the [LOGOUT] key (\*) cannot be used to log out when a fax number is being entered in fax mode, as the key is used for fax number entry.
- If a preset duration of time elapses after the machine is last used, the Auto Clear function will activate. When Auto Clear activates, logout takes place automatically. However, when PC Scan mode is used, logout does not take place when the [LOGOUT] key (\*) is pressed and Auto Clear does not operate. Change to a different mode on the machine and then log out.

### If an incorrect user number is entered 3 times in a row...

If "A Warning when Login Fails" is enabled in the system settings (administrator), the machine will lock for 5 minutes if an incorrect user number is entered 3 times in a row.

Verify the user number that you should use with the administrator of the machine.



The administrator can clear the locked state. This is done from [User Control] and then [Default Settings] in the Web page menu.

# AUTHENTICATION BY LOGIN NAME / PASSWORD

The following procedure is used to log in using a login name and password received from the administrator of the machine or the administrator of the LDAP server.

## When controlled by login name and password

(Different items will appear in the screen when LDAP authentication is used.)

1

## Touch the [Login Name] key or the key.

If the [Login Name] key is touched, a screen for selecting the user name appears. Go to the next step.

If the  key is touched, an area for entering a "Registration No." appears [---].

Use the numeric keys to enter your registration number that has been stored in "User List" in the system settings (administrator). After entering the registration number, go to step 3.

2

## Select the user name.

### (A) [Direct Entry] key

Use this key if you have not been stored in "User List" in the system settings (administrator) and are only using LDAP authentication.

A text entry screen will appear. Enter your login name.

### (B) User selection keys

Touch your user name that has been stored in "User List" in the system settings (administrator).

### (C) [Back] key

Touch this key to return to the login screen.

### (D) Index tabs

All users appear on the [All] tab. Users are grouped on the other tabs according to the search characters entered when each user was stored.



LDAP authentication can be used when the administrator of the server provides LDAP service on the LAN (local area network).



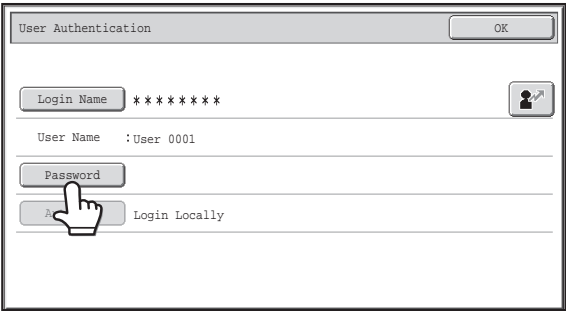

**Touch the [Password] key.**

A text entry screen for entering the password will appear. Enter your password that is stored in "User List" in the system settings (administrator).

If you are logging in to a LDAP server, enter the password that is stored with your LDAP server login name. Each entered character will be displayed as "\*". When you have finished entering the password, touch the [OK] key. When authentication is by LDAP server and you have different passwords stored in "User List" in the system settings (administrator) and in the LDAP server, use the password stored in the LDAP server.



- When a LDAP server has been stored, [Auth to:] can be changed.
- **If you are logging in using a user selection key...**  
The LDAP server was stored when your user information was stored, and thus the LDAP server will appear as the authentication server when you select your login name. Go to step 4.
- **When logging in using the [Direct Entry] key...**  
Touch the [Auth to:] key.

3

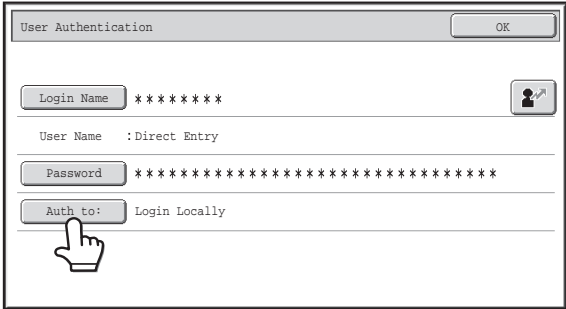

Select the LDAP server and touch the [OK] key.

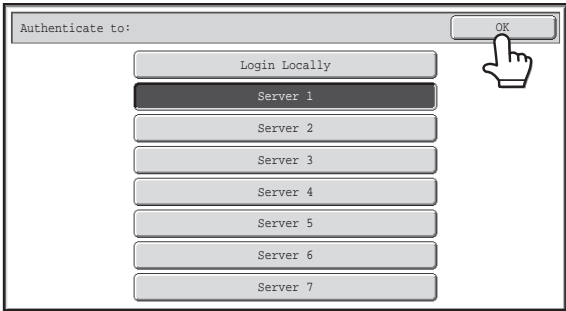

4

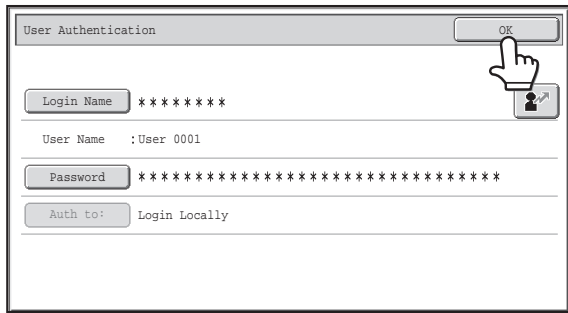

(Different items will appear in the screen when LDAP authentication is used.)

**Touch the [OK] key.**

After the entered login name and password are authenticated, the user count screen will appear briefly.

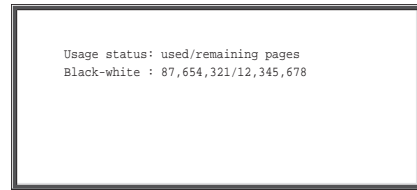

When page limits have been set in "Pages Limit Group List" in the system settings (administrator), the number of pages remaining will appear. (The remaining number of pages that the user can use in each mode (copy, scan, etc.) appears.) The amount of time that this screen appears can be changed using "Message Time Setting" in the system settings (administrator).

5

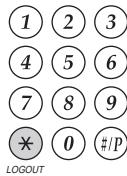

**When you have finished using the machine and are ready to log out, press the [LOGOUT] key (\*).**



- However, note that the [LOGOUT] key (\*) cannot be used to log out when a fax number is being entered in fax mode, as the key is used for fax number entry.
- If a preset duration of time elapses after the machine is last used, the Auto Clear function will activate. When Auto Clear activates, logout takes place automatically. However, when PC Scan mode is used, logout does not take place when the [LOGOUT] key (\*) is pressed and Auto Clear does not operate. Change to a different mode on the machine and then log out.

**If an incorrect login name or password is entered 3 times in a row...**

If "A Warning when Login Fails" is enabled in the system settings (administrator), the machine will lock for 5 minutes if an incorrect login name or password is entered 3 times in a row.

Verify the login name and password that you should use with the administrator of the machine.



- The administrator can clear the locked state. This is done from [User Control] and then [Default Settings] in the Web page menu.
- When LDAP authentication is used, the [E-mail Address] key may appear, depending on the authentication method. If the [E-mail Address] key appears in step 3, touch the key. A text entry screen will appear. Enter your e-mail address.



**System Settings (Administrator): User List**

This is used to store names of users of the machine. Detailed information such as the login name, user number, and password are also stored. Ask the administrator of the machine for the information that you need to use the machine.

# HOME SCREEN

When the [HOME] key is pressed on the operation panel, the home screen appears in the touch panel. Mode selection keys appear in the home screen. These keys can be touched to open the base screen of each mode. The [My Menu] key can be touched to display shortcuts to functions stored in "My Menu".

1st screen

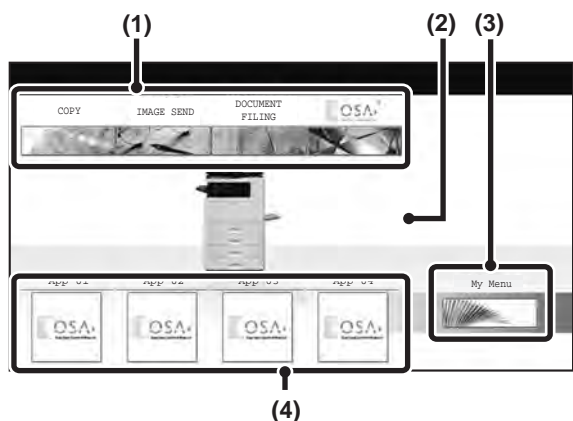

2nd screen

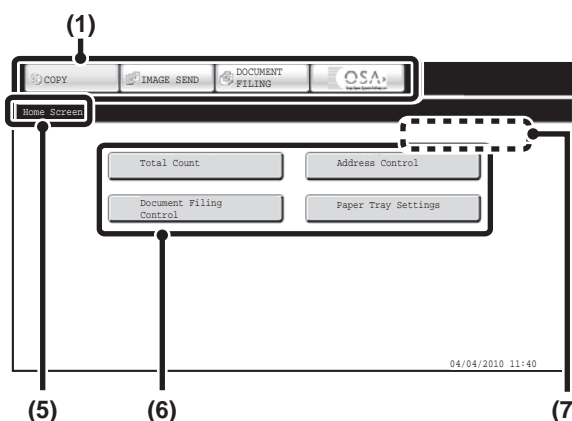

## (1) Mode select keys

Use these keys to switch between copy, image send, document filing, and Sharp OSA modes. Key names and images can be changed. (1st screen only)

## (2) Background Image

Background image of the home screen. The background image can be changed.

## (3) [My Menu] key

Touch to go to your my menu screen. Key names and images can be changed.

## (4) Application Keys

It is possible to display a combined total of eight Sharp OSA application shortcuts and my menu shortcuts.

## (5) Title

This shows the title of the my menu screen.

## (6) Shortcut key

A registered function appears as a shortcut key. The key can be touched to select the registered function.

## (7) User name

This shows the name of the logged in user. The user name appears when user authentication is enabled on the machine.

Shortcuts to functions can be registered as keys in the my menu screen. When a shortcut key is touched, the screen for that function appears. Register frequently used functions in the my menu screen to quickly and conveniently access those functions. When user authentication is used, the my menu screen of "Favorite Operation Group" can be displayed.

Use the Web page to configure the following settings:

- Changing the name of the home screen key, changing the image, storing an application key
- Storing keys that appear in the my menu screen.



### • System Settings (Administrator): My Menu Settings

Registration is performed in [System Settings] - [Operation Settings] - [My Menu Settings] in the Web page menu.

### • System Settings (Administrator): My Menu List

When user authentication is enabled, a my menu screen can be set for each "Favorite Operation Group List". Registration is performed in "My Menu List" in [User Control] in the Web page menu.

# REMOTE OPERATION OF THE MACHINE

The remote operation function allows you to operate the machine from your computer.

When this function is added, the same screen as the operation panel screen appears on your computer. This allows you to operate the machine from your computer in the same way as if you were standing in front of the machine.

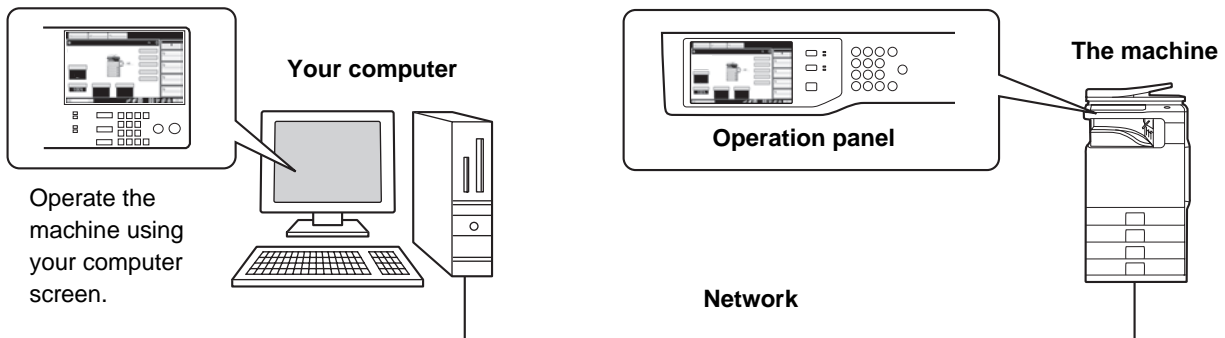

The remote operation function can only be used on one computer at a time.

## How to use the remote operation function

Before using this function, set "Operational Authority" to "Allowed" in "Remote Software Operation" of "Remote Operation Settings" in the system settings (administrator).

➤ 7. SYSTEM SETTINGS "Remote Operation Settings" (page 7-68)

To use the remote operation function, the machine must be connected to a network and a VNC application must be installed on your computer (recommended VNC software: RealVNC).

The procedure for using this function is as follows:

### Example: RealVNC

1

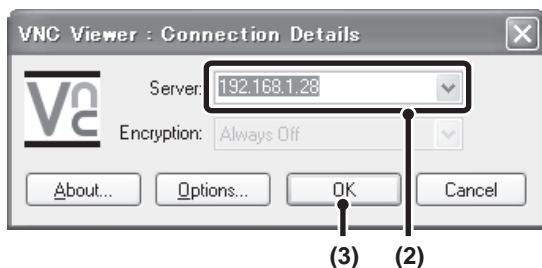

**Connect from the computer to the machine.**

- (1) Start the VNC viewer
- (2) Enter the IP address of the machine in the "Server" entry box.
- (3) Click the [OK] button.

2

**Follow the prompts on the operation panel of the machine to permit the connection.**



When the machine is connected to the remote software,  appears on the system bar of the machine's touch panel. If you wish to disconnect, exit the remote software or touch .



Use the operation panel in the same way as you would on the machine. Note that a key cannot be held down to continuously change a value being entered. For detailed procedures, see the chapters for each of the functions in this manual.



#### **System Settings (Administrator): Remote Operation Settings**

Set the operation authority for the remote operation function.

These settings can also be configured in the Web pages. Click "System Settings", "Operation Setting" and then "Remote Operation Settings" in the Web page menu.

# ITEMS RECORDED IN THE JOB LOG

The machine records the jobs that are performed in the job log.

The items recorded in the Job Log can be viewed by saving the file using "Job Log" - "Save/Delete Job log" in the Web page. The log can also be shown in the Web page using "View Job Log".

The main information that is recorded in the job log is described below.



- The file saved using "Save/Delete Job log" always records usage based on fixed items regardless of which peripheral devices are installed and the purpose of the log, enabling easy totaling when machines have different configurations. For this reason, items may appear in the log for functions that are not available on the machine.
- In some cases, job information may not be correctly recorded, such as when a power failure occurs during a job.

	Item name	Description
Main items	Job ID	The job ID is recorded. Job IDs appear in the log as consecutive numbers up to a maximum of 999999, after which the count resets to 1.
	Job Mode	The job mode, such as copy or print.
	Computer Name	The name of the computer that sent a print job.*
	User Name	The user name when the user authentication function is used.
	Login Name	The login name when the user authentication function is used.
	Starting Date & Time	The date and time the job was started.
	Completing Date & Time	The date and time the job was completed.
	Black & White Total Count	For a print job, the total count is recorded. For a send job, the number of transmitted black & white pages is recorded. When a broadcast transmission is summarized, the total number of pages is recorded. For a scan to HDD job, the number of stored black & white pages is recorded.
	Full Color Total Count	For a send job, the total number of transmitted full color pages is recorded. When a broadcast transmission is summarized, the total number of pages is recorded. For a scan to HDD job, the number of stored full color pages is recorded.
	Count according to size	Counts by original/paper size in color mode and black & white mode.
	Number of sheets according to size	Indicates the sheet count by paper type.
	Invalid Paper Count(Black & White)	Indicates the black & white invalid sheet count.
	Number of Reserved Sets	Number of specified sets or reserved destinations.
	Number of Completed Sets	Number of completed sets or number of destinations to which transmission was successfully completed.
	Number of Reserved Pages	Number of reserved original pages of a copy, print, scan job, or other job.
Number of Completed Pages	Number of completed pages of a set.	
Result	The result of a job.	
Error Cause	When an error occurs during a job, the cause of the error.	

	<b>Item name</b>	<b>Description</b>
Print Job Related Item	Output	The output mode of a printed job.
	Staple	The status of stapling.
	Staple Count	The staple count.
	Printer Tone	The tone used for a print job.
Image Send Related Item	Direct Address	Address of an image send job.
	Sender Name	Sender name of an image send job.
	Sender Address	Sender address of an image send job.
	Transmission Type	Transmission type of an image send job.
	Administrative Serial Number	Administrative serial number of an image send job.
	Broadcast number	Broadcast number of an image send job.
	Entry Order	Reservation order for broadcast transmission of an image send job. For a serial polling job, this is used to correlate communication with printing.
	File Type	File format of an image send job.
	Compression Mode/Compression Ratio	Compression mode and compression ratio of the file of an image send job.
	Communication Time	Indicates the communication time of image send jobs.
	Fax No.	Indicates the stored sender's number.
Document Filing Related Item	Document Filing	A log is kept of document filing usage
	Storing Mode	The save mode of document filing is recorded.
	File Name	Files saved using document filing and file names stored using retention print are recorded.*1
	Data Size [KB]	The file size is recorded.
Common Functionality	Color Setting	Color mode selected by user.
	Special Modes	Special modes selected when the job was executed.
	File Name 2	Records the file names of print jobs.*1
Detailed Items	Original Size	Size of scanned original.*2 For a document filing print job, the paper size of the file.
	Original Type	Original type (text, printed photo, etc.) set in the exposure settings screen.
	Paper Size	For a print job, the paper size. For a send job, the transmitted paper size. For a Scan to HDD job, the paper size of the stored file.
	Paper Type	The paper type used for printing.
	Paper Property: Disable Duplex	Indicates that duplex was disabled in "Paper Type".
	Paper Property: Fixed Paper Side	Indicates that fixed side was specified in "Paper Type".
	Paper Property: Disable Staple	Indicates that stapling was disabled in "Paper Type".
	Duplex Setup	Indicates the duplex setting.
	Resolution	Indicates the scanning resolution.

	<b>Item name</b>	<b>Description</b>
Machine Item	Model Name	Indicates the model name of the machine.
	Unit Serial Number	Indicates the serial number of the machine.
	Name	Indicates the name of the machine that is set in the Web pages.
	Machine Location	Indicates the installation location of the machine that is set in the Web pages.

\*1 In some environments this is not recorded.

\*2 "Check Size" and "Card Size" are recorded as Custom size (MX-B402SC Only).

# LOADING PAPER

## IMPORTANT POINTS ABOUT PAPER

This section provides information that you should know before loading paper in the paper trays. Be sure to read this section before loading paper.

## NAMES AND LOCATIONS OF TRAYS

The names of the trays are as follows.

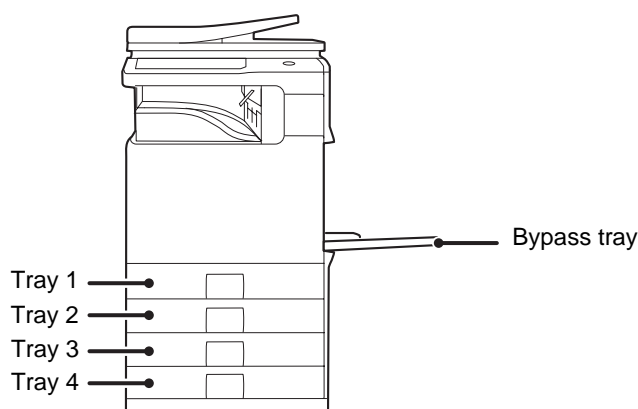

## USEABLE PAPER

Various types of paper are sold. This section explains what plain paper and what special media can be used with the machine. For detailed information on the sizes and types of paper that can be loaded in each tray of the machine, see the specifications in the Start Guide and "[Paper Tray Settings](#)" (page 7-14) in "7. SYSTEM SETTINGS".

### Plain paper, special media

#### Plain paper that can be used

- SHARP standard plain paper (21 lbs. (80 g/m<sup>2</sup>)). For paper specifications, see the specifications in the Start Guide.
- Plain paper other than SHARP standard paper (16 lbs. to 28 lbs. (60 g/m<sup>2</sup> to 105 g/m<sup>2</sup>))  
Recycled paper, colored paper and pre-punched paper must meet the same specifications as plain paper. Contact your dealer or nearest SHARP Service Department for advice on using these types of paper.

\* The "lbs." (g/m<sup>2</sup>) units used in these explanations indicate the weight of the paper.



## Types of paper that can be used in each tray

The following types of paper can be loaded in each tray.

"-" in the table indicates "cannot be used".

	Tray 1/Tray 2/Tray 3/Tray 4	Bypass tray
Plain paper	Permitted	Permitted
Pre-printed	Permitted	Permitted
Recycle Paper	Permitted	Permitted
Letter head	Permitted	Permitted
Pre-punched	Permitted	Permitted
Color	Permitted	Permitted
Heavy paper*1	-	Permitted
Labels	-	Permitted
Transparency film	-	Permitted
Envelopes	-	Permitted
Thin paper*2	-	Permitted

\*1 "Heavy paper" is heavy paper up to 110 lbs. index (209 g/m<sup>2</sup>).

\*2 Thin paper from 13 lbs. to 16 lbs. (55 g/m<sup>2</sup> to 59 g/m<sup>2</sup>) can be used.

## Print side face up or face down

Paper is loaded with the print side face up or face down depending on the paper type and tray.

The loading orientation of punched paper, letterhead paper, and pre-printed paper differs from that of other paper.

For details, see "[Example: Placement orientations of punched paper, letter head paper, and pre-printed paper](#)" (page 1-29).

### Trays 1 to 4

Load the paper with the print side face up.

However, if the paper type is "Pre-Punched", "Letter Head" or "Pre-Printed", load the paper with the print side face down\*.

### Bypass tray

Load the paper with the print side face down.

However, if the paper type is "Pre-Punched", "Letter Head" or "Pre-Printed", load the paper with the print side face up\*.

\* If "Disabling of Duplex" is enabled in the system settings (administrator), load the paper in the normal way (face up in trays 1 to 4; face down in the bypass tray).

**Example: Placement orientations of punched paper, letter head paper, and pre-printed paper**

This explanation assumes that "Disabling of Duplex" is not enabled in the system settings (administrator).

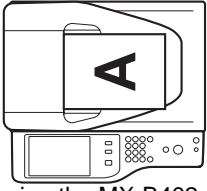
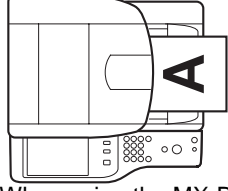
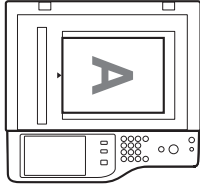
Document feeder tray	Original glass
 When using the MX-B402  When using the MX-B402SC	

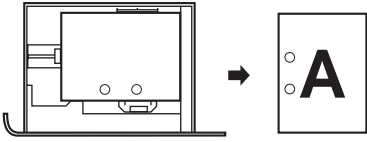
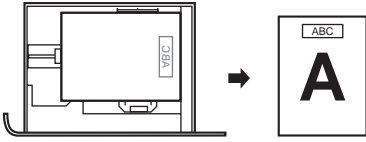
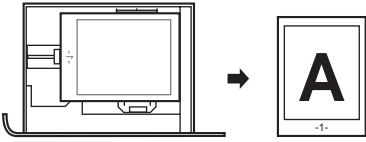
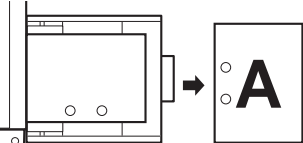
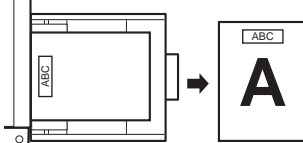
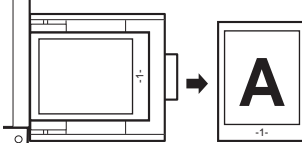
	Pre-punched (Left binding)	Letter head	Pre-printed
Tray 1 to 4	 Load the paper print side down with the punch holes to the front and the top edge to the right.	 Load the paper print side down with the letter head (top edge) to the right.	 Load the paper print side (pre-printed side) down with the top edge to the right.
Bypass tray	 Load the paper print side up with the punch holes to the front and the top edge to the left.	 Load the paper print side up with the letter head (top edge) to the left.	 Load the paper print side (pre-printed side) up with the top edge to the left.

**Paper that cannot be used**

- Special media for inkjet printers (fine paper, glossy paper, glossy film, etc.)
- Carbon paper or thermal paper
- Pasted paper
- Paper with clips
- Paper with fold marks
- Torn paper
- Oil-feed transparency film
- Tracing paper
- Thin paper less than 15 lbs. (55 g/m<sup>2</sup>)
- Paper that is 57 lbs. (210 g/m<sup>2</sup>) or heavier
- Irregularly shaped paper
- Stapled paper
- Damp paper
- Curled paper
- Paper on which either the print side or the reverse side has been printed on by another printer or multifunction device.
- Paper with a wave-like pattern due to moisture absorption

**Non-recommended paper**

- Iron-on transfer paper
- Japanese paper
- Perforated paper

**!** Various types of plain paper and special media are sold. Some types cannot be used with the machine. Contact your dealer or nearest SHARP Service Department for advice on using these types of paper.

The image quality and toner fusibility of paper may change due to ambient conditions, operating conditions, and paper characteristics, resulting in image quality inferior to that of SHARP standard paper. Contact your dealer or nearest SHARP Service Department for advice on using these types of paper.

The use of non-recommended or prohibited paper may result in skewed feeding, misfeeds, poor toner fusing (the toner does not adhere to the paper well and can be rubbed off), or machine failure.

The use of non-recommended paper may result in misfeeds or poor image quality. Before using non-recommended paper, check if printing can be performed properly.

# TRAY SETTINGS FOR TRAY 1 TO 4

## LOADING PAPER AND CHANGING THE PAPER SIZE

A maximum of 500 sheets of paper from size 5-1/2" x 8-1/2" to size 8-1/2" x 14" (A5 to A4) can be loaded in trays 1 and 2.  
A maximum of 500 sheets of paper from size 7-1/4" x 10-1/2" to size 8-1/2" x 14" (B5 to A4) can be loaded in trays 3 and 4.

1

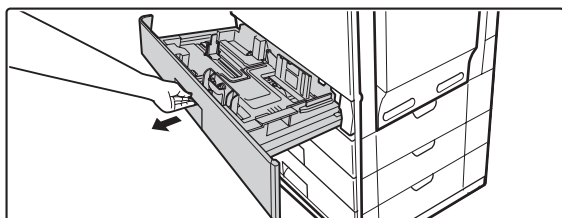

### Pull out the paper tray.

Gently pull the tray out until it stops.

To load paper, go to step 3. To load a different size of paper, go to the next step.



Do not pull hard on the tray. This may cause failure.

2

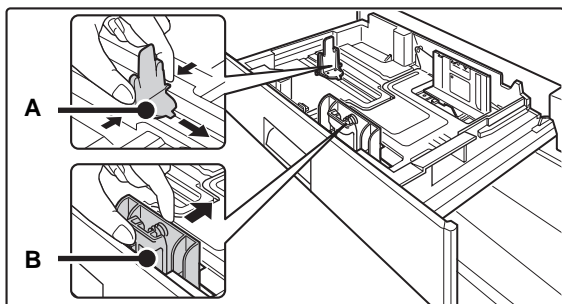

### Adjust the guide plates A and B by squeezing their lock levers and sliding them to match the vertical and horizontal dimensions of the paper to be loaded.

The guide plates A and B are slidable. Slide each guide plate while squeezing its lock lever.



- Be sure to place the guide to match the size of the paper. If the guide is not placed correctly, paper skewing or misfeeds may occur.
- The loaded paper should not go higher than these protrusions.

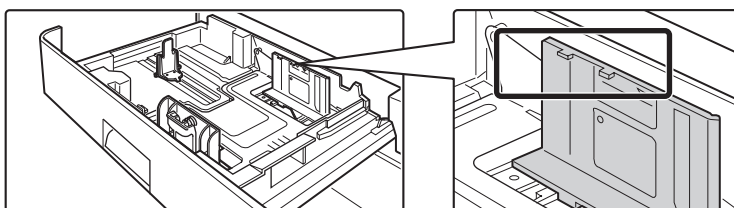

3

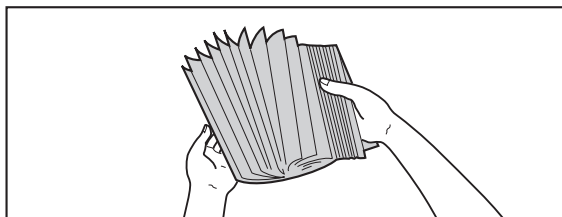

### Fan the paper.

Fan the paper well before loading it. If the paper is not fanned, multiple sheets may feed at once and cause a misfeed.



When handling paper, take care not to cut yourself on the edges of the paper.

4

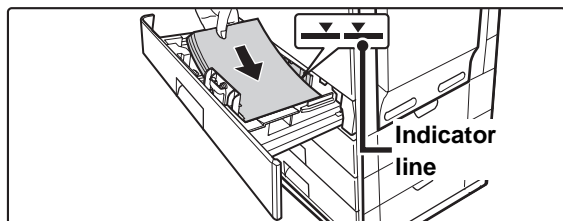

### Insert the paper into the tray.

Load the paper with the print side face up. The stack must not be higher than the indicator line (maximum of 500 sheets).



- If paper is loaded higher than the line, paper misfeeds may occur.
- When pushing in a tray, take care that your fingers do not become pinched in the tray.

5

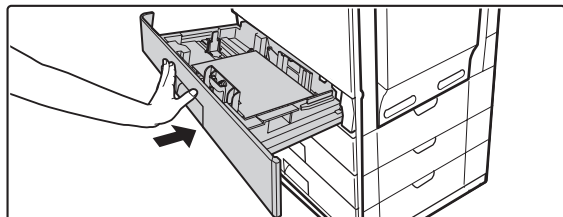

### Gently push the paper tray into the machine.

Push the tray firmly all the way into the machine.



When pulling out a tray after paper is loaded, do not pull hard. The tray may be damaged, the machine may topple, and injury may result.



If you loaded a different type or size of paper than was loaded previously, be sure to change the "Paper Tray Settings" in the system settings. If these settings are not configured correctly, automatic paper selection will not operate correctly and printing may take place on the wrong size or type of paper, or a misfeed may occur.

### Caution

**If children are present, ensure that the children do not sit or play on a tray that has been pulled out. Sitting on a tray may damage the tray and cause the machine to topple, resulting in injury.**



Do not place heavy objects on the tray or press down on the tray.



**System Settings: [Paper Tray Settings](#) (page 7-14)**

Change these settings when you change the size or type of paper loaded in a tray.

# 500-SHEET PAPER FEED UNIT SPECIFICATIONS

Model	MX-CSX1 (tray 2)	MX-CSX2 (tray 3, tray 4)
Paper sizes	8-1/2" x 14", 8-1/2" x 13-1/2", 8-1/2" x 13-2/5", 8-1/2" x 13", 8-1/2" x 11", 7-1/4" x 10-1/2", 5-1/2" x 8-1/2"* , A4, B5, A5* , 16K	
Paper weight	Plain paper (16 lbs. to 28 lbs. (60 g/m <sup>2</sup> to 105 g/m <sup>2</sup> ))	
Paper capacity	500 sheets (21 lbs. (80 g/m <sup>2</sup> )) x 1 tray	
Paper types	SHARP-recommended plain paper, recycled paper, and colored paper	
Automatic paper size detection	When "Auto-Inch" detection is selected: 8-1/2" x 14", 8-1/2" x 11", 7-1/4" x 10-1/2", 5-1/2" x 8-1/2"* When "Auto-AB" detection is selected: A4, B5, A5* , 216 mm x 330 mm (8-1/2" x 13")	
Power supply	Supplied from the machine	
Dimensions	21-1/16" (W) x 17-1/4" (D) x 4-13/32" (H) (535 mm (W) x 438 mm (D) x 112 mm (H)) (not including adjuster)	21-1/16" (W) x 17-1/4" (D) x 4-21/64" (H) (535 mm (W) x 438 mm (D) x 110 mm (H)) (not including adjuster)
Weight	Approx. 15.0 lbs. (6.8 kg)	Approx. 12.3 lbs. (5.6 kg)

\* Only MX-CSX1 can be used.

# LOADING PAPER IN THE BYPASS TRAY

The bypass tray can be used to print on plain paper, envelopes, label sheets, and other special media. Up to 100 sheets of paper can be loaded (up to 40 sheets of heavy paper) for continuous printing similar to the other trays.

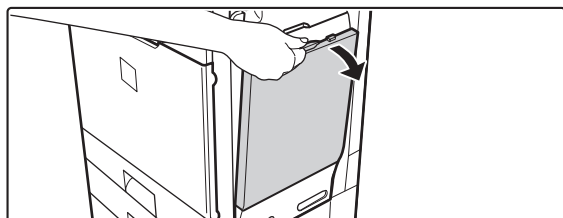

**Open the bypass tray.**

1

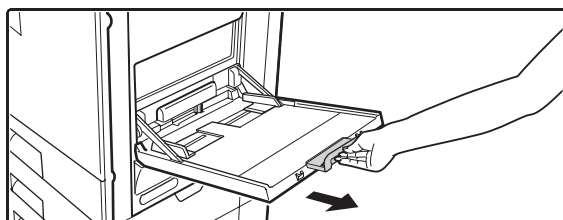

When loading paper larger than 8-1/2" x 11" or A4, be sure to pull out the bypass tray extension. Pull the bypass tray extension all the way out. If the bypass tray extension is not pulled all the way out, the size of the loaded paper will not be correctly displayed.



Do not place heavy objects on the bypass tray or press down on the tray. The bypass tray may be damaged, the machine may topple, and injury may result.

2

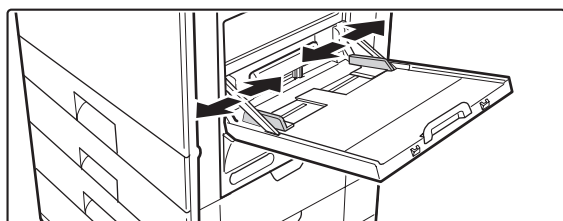

**Set the bypass tray guides to the width of the paper.**

3

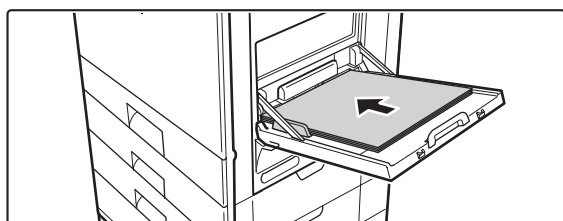

**Insert the paper along the bypass tray guides all the way into the bypass tray until it stops.**

Load the paper with the print side face down.



- Do not force the paper in.
- If the bypass tray guides are set wider than the paper, move the bypass tray guides in until they correctly fit the width of the paper. If the bypass guides are set too wide, the paper may skew or be creased.

## Caution

If children are present, ensure that the children do not sit or play on a bypass tray that has been pulled out. Sitting on a tray may damage the tray and cause the machine to topple, resulting in injury.

## IMPORTANT POINTS WHEN USING THE BYPASS TRAY

- When using plain paper other than SHARP standard paper or special media other than SHARP-recommended transparency film, or when printing on the reverse side of previously used paper, the paper must be loaded one sheet at a time. Loading more than one sheet at a time will cause misfeeds.
- Before loading paper, straighten any curling in the paper. If curled paper is not straightened, a misfeed may occur.
- When adding paper, remove any paper remaining in the bypass tray, combine it with the paper to be added, and reload as a single stack. If paper is added without removing the remaining paper, a misfeed may result.

### Inserting paper

Place paper in the horizontal orientation.

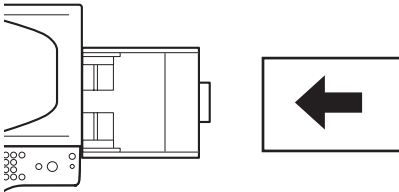

### Inserting transparency film

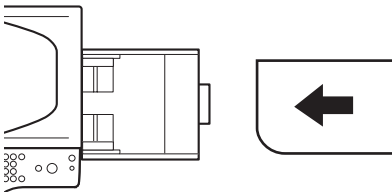

- Use SHARP-recommended transparency film. When using transparency film, place the film on the bypass tray with the rounded corner at the left front. This ensures that the print side faces in the correct direction.
- Do not touch the print side of transparency film.
- When loading multiple sheets of transparency film in the bypass tray, be sure to fan the sheets several times before loading.
- When printing on transparency film, be sure to remove each sheet as it exits the machine. Allowing sheets to stack in the output tray may result in curling.

## Loading envelopes

When inserting envelopes in the bypass tray, place them aligned to the left side in the orientation shown below. Only the front side of envelopes can be printed on. Be sure to place the front side face down. When loading envelopes, load one envelope at a time.

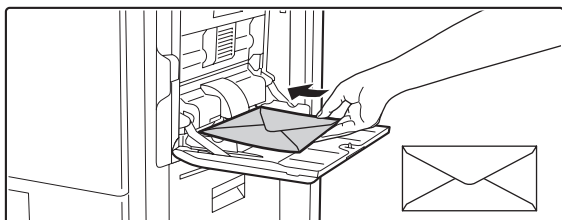

- Do not print on both sides of an envelope. This may result in misfeeds or poor print quality.
- Some operating environments may cause creasing, smudging, misfeeds, poor toner fusing, or machine failure.



Restrictions apply to some types of envelopes. For more information, consult a qualified service technician.

## Important points when using envelopes

### Envelopes that cannot be used

Do not use the following envelopes. Envelopes misfeed, and smudges may result.

- Envelopes with metal clasps
- Plastic hooks, or ribbon hooks
- Envelopes closed with string
- Envelopes with windows or backing
- Envelopes with an uneven front surface due to embossing
- Double-layer envelopes
- Envelopes with an adhesive for sealing
- Hand-made envelopes
- Envelopes with air inside
- Envelopes with creases, fold marks, torn or damaged envelopes
- Envelopes with an incorrectly aligned corner gluing position on the back cannot be used as creasing may result.

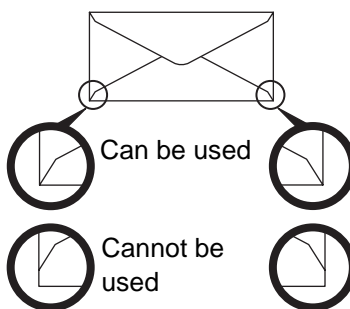

### Print quality on envelopes

- Print quality is not guaranteed in the area 13/32" (10 mm) around the edges of the envelope.
- Print quality is not guaranteed on parts of envelopes where there is a large step-like change of thickness, such as on four-layer parts or parts less than three layers.
- Print quality is not guaranteed on envelopes having peel off flaps for sealing the envelopes.



## Fusing unit pressure adjusting levers

In some cases damage to the envelopes or smudging may occur even if envelopes within the specifications are used. This problem may be alleviated by shifting the fusing unit pressure adjusting levers from their "normal pressure position" to the "lower pressure position". Follow the procedure on the this page.

1

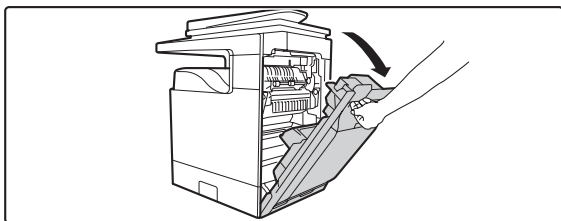

### Open the right side cover

While pushing up the open/close lever on the right side cover, gently open the cover.

2

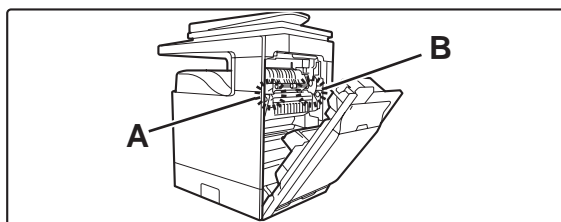

Lower pressure position

Move the fusing unit pressure adjusting levers (two) to the lower pressure position as shown.

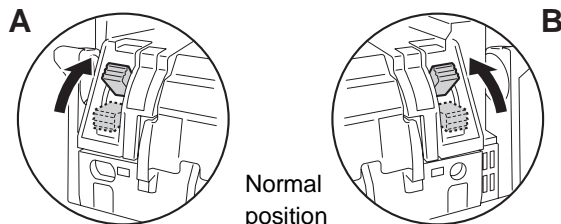

Normal position

3

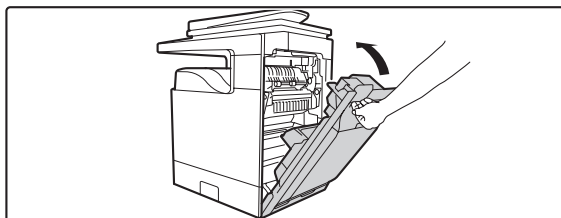

Close the right side cover.

4

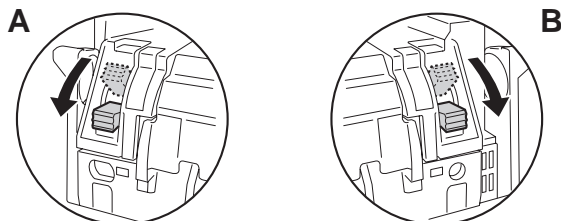

Return the lever to the normal position when finished feeding envelopes.

### Caution

The fusing unit is hot. Take care not to burn yourself when operating the fusing unit pressure adjusting levers.



Be sure to return the levers to the "normal pressure position" before printing or copying on paper other than envelopes. Otherwise, fusing problems, paper misfeeds, or equipment failure may occur.

# ORIGINALS

This section explains how to place originals in the automatic document feeder and on the document glass.

## PLACING THE ORIGINAL

### PLACING ORIGINALS IN THE AUTOMATIC DOCUMENT FEEDER

This section explains how to place originals in the automatic document feeder.

#### Allowed original sizes

Minimum original size	Maximum original size
<p><b>Standard sizes</b> 5-1/2" (height) x 8-1/2" (width) A5: 148 mm (height) x 210 mm (width)</p> <p><b>Non-standard sizes</b> (Minimum size that can be specified manually)</p> <p><b>MX-B402:</b> 1-sided scanning: 4" (height) x 3-1/2" (width) (100 mm (height) x 89 mm (width)) 2-sided scanning: 4" (height) x 5-7/8" (width) (100 mm (height) x 148 mm (width))</p> <p><b>MX-B402SC:</b> 2" (height) x 3-1/4" (width) (51 mm (height) x 85 mm (width))</p>	<p><b>Standard sizes</b> 8-1/2" (height) x 14" (width) A4: 210 mm (height) x 297 mm (width)</p> <p><b>Non-standard sizes</b> (Maximum size that can be specified manually)</p> <p>Copy mode: 8-1/2" (height) x 14" (width) 216 mm (height) x 356 mm (width) Image send mode: 8-1/2" (height) x 19-5/8" (width) 216 mm (height) x 500 mm (width)</p>

When the original is a non-standard size, see the appropriate explanation below for the mode you are using.

- ☞ 2. COPIER "SPECIFYING THE ORIGINAL SIZE" (page 2-29)
- ☞ 4. FACSIMILE "IMAGE SETTINGS" (page 4-45)
- ☞ 5. SCANNER / INTERNET FAX "IMAGE SETTINGS" (page 5-54)

#### Allowed original weights

	MX-B402	MX-B402SC
<b>1-sided scanning</b>	9 lbs. to 32 lbs. (35 g/m <sup>2</sup> to 128 g/m <sup>2</sup> )	9 lbs. to 75 lbs. (35 g/m <sup>2</sup> to 280 g/m <sup>2</sup> )
<b>2-sided scanning</b>	13 lbs. to 28 lbs. (50 g/m <sup>2</sup> to 105 g/m <sup>2</sup> )	13 lbs. to 75 lbs. (50 g/m <sup>2</sup> to 280 g/m <sup>2</sup> )



- For the MX-B402SC, when scanning originals from 34 lbs. to 74 lbs. (129 g/m<sup>2</sup> to 280 g/m<sup>2</sup>), select "Heavy Exit" for the original exit place.
- To scan originals from 9 lbs. to 14 lbs. (35 g/m<sup>2</sup> to 49 g/m<sup>2</sup>), use "Slow Scan Mode" in the special modes. Scanning without using "Slow Scan Mode" may result in original misfeeds. When "Slow Scan Mode" is selected, automatic 2-sided scanning is not possible.

## Useable card specification

### MX-B402SC Only

Please use cards that conform to ISO 7810 ID-1/ID-2 types.

	ID-1	ID-2
<b>Size</b>	2 1/8" (height) x 3 3/8" (width) (54 mm (height) x 86 mm (width))	3" (height) x 4 1/4" (width) (74 mm (height) x 105 mm (width))
<b>Thickness</b>	1/32" (0.76 mm) ± 1/64"(0.08 mm)	
<b>Material</b>	Polyvinyl chloride (PVC) or polyvinyl acetate (PVA/PVAC)	

- Cards with embossing cannot be scanned.
- Cards that are hard and difficult to bend may not feed well.
- If the card surface is soiled with oils (finger oil, etc.), wipe it off first before scanning.

## Originals that cannot be fed through the automatic document feeder

Do not use the following originals. Original misfeeds, and smudges may result.

- Transparency film
- Tracing paper
- Carbon paper
- Thermal paper or originals printed with thermal transfer ink ribbon
- Originals to be fed through the feeder should not be damaged, crumpled, folded, loosely pasted together, or have cut-out holes
- Originals with multiple punched holes other than two-hole or three-hole punched paper
- Originals that have been scanned multiple times in the automatic document feeder and have become creased or folded.
- Originals that have absorbed moisture and become soft.

## When using the MX-B402

1

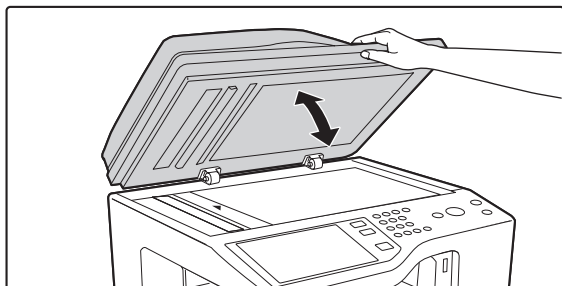
**Make sure an original does not remain on the document glass.**

Open the automatic document feeder, make sure that an original is not on the document glass, and then gently close the automatic document feeder.



When closing the automatic document feeder, take care that your fingers do not become pinched.

2

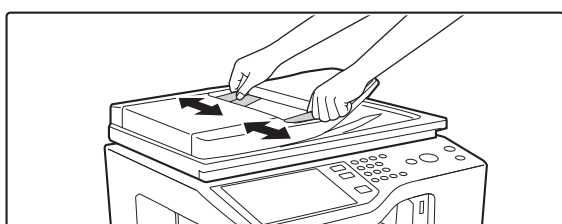
**Adjust the original guides to the size of the originals.**

3

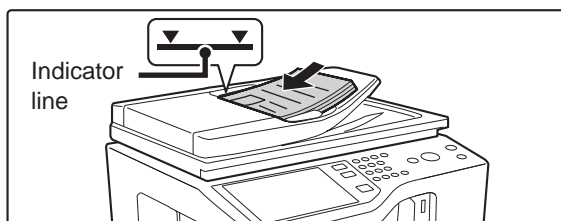
**Place the originals.**

Make sure the edges of the originals are even. Insert the originals face up all the way into the document feeder tray.

Insert a number of originals that does not exceed the indicator line on the document feeder tray.

Up to 50 sheets can be inserted.

Be sure to remove originals that have been finished scanning from the original exit tray.



- Do not insert your hand into the document insertion opening in the automatic document feeder.
- If originals are placed higher than the line, misfeeds may occur.



- Before inserting originals into the document feeder tray, be sure to remove any staples or paper clips.
- If originals have damp spots due to correction fluid, ink or pasteup glue, wait until the originals are dry before making copies. Otherwise the interior of the document feeder or the document glass may be soiled.
- When using originals with two or three holes, place them so that the punched edge is at a position away from the feed slot of the document feeder tray.

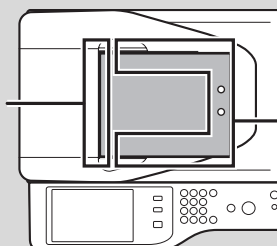

Hole positions

## When using the MX-B402SC

1

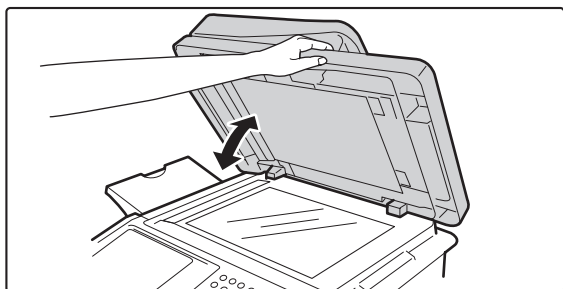
**Make sure an original does not remain on the document glass.**

Open the automatic document feeder, make sure that an original is not on the document glass, and then gently close the automatic document feeder.



When closing the automatic document feeder, take care that your fingers do not become pinched.

2

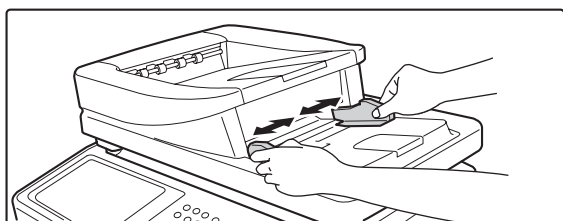
**Adjust the original guides to the size of the originals.**

3

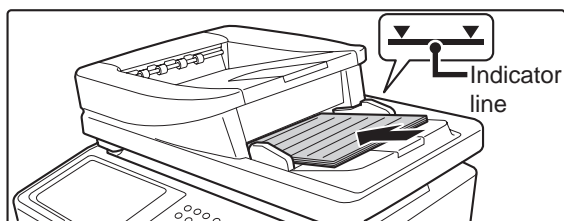
**Place the originals.**

Make sure the edges of the originals are even. Insert the originals face up all the way into the document feeder tray.

Insert a number of originals that does not exceed the indicator line on the document feeder tray.

Up to 100 sheets can be inserted.

Please remove originals that have finished being read with the automatic document feeder from the original output portion's upper exit or heavy exit. Heavy paper (34 lbs. to 75 lbs. (129 g/m<sup>2</sup> to 280 g/m<sup>2</sup>)) and plastic cards can be output only on heavy exit.



- Do not insert your hand into the document insertion opening in the automatic document feeder.
- If originals are placed higher than the line, misfeeds may occur.



- Before inserting originals into the document feeder tray, be sure to remove any staples or paper clips.
- If originals have damp spots due to correction fluid, ink or pasteup glue, wait until the originals are dry before making copies. Otherwise the interior of the document feeder or the document glass may be soiled.
- When using originals with two or three holes, place them so that the punched edge is at a position away from the feed slot of the document feeder tray.

Feed slot

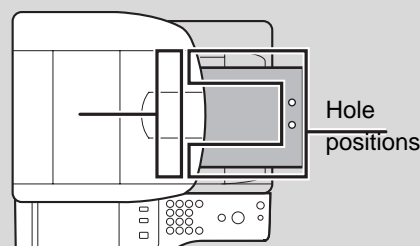

# PLACING THE ORIGINAL ON THE DOCUMENT GLASS

This section explains how to place the original on the document glass.

## Allowed original sizes

Maximum original size
<b>Standard sizes</b> 8-1/2" (height) x 11" (width) A4: 210 mm (height) x 297 mm (width)
<b>Non-standard sizes</b> 8-1/2" (height) x 11-11/16" (width) 216 mm (height) x 297 mm (width)

When the original is a non-standard size, see the appropriate explanation below for the mode you are using.

- 2. COPIER "SPECIFYING THE ORIGINAL SIZE" (page 2-29)
- 4. FACSIMILE "IMAGE SETTINGS" (page 4-45)
- 5. SCANNER / INTERNET FAX "IMAGE SETTINGS" (page 5-54)

1

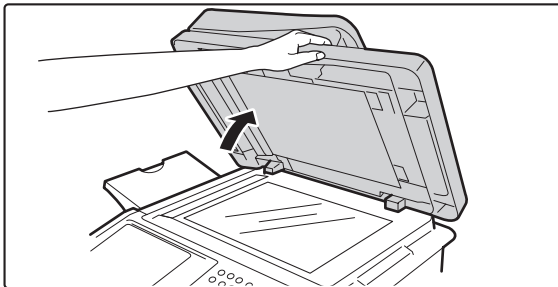

**Open the automatic document feeder.**

2

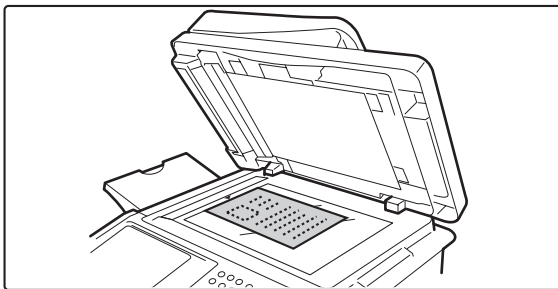

**Place the original.**

Place the original face down in the left center position of the document glass.

### Document glass scale

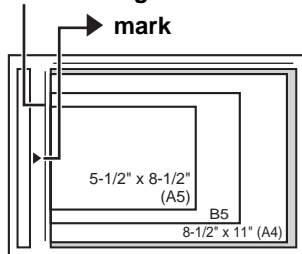

**All originals should be placed in the left center position.**  
Align the middle of the original with the tip of the ► mark.

3

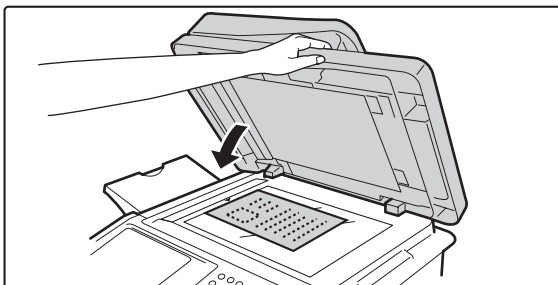

**Close the automatic document feeder.**

After placing the original, be sure to close the automatic document feeder. If left open, parts outside of the original will be copied black, causing excessive use of toner.

## Placing a thick book

When scanning a thick book or other thick original, follow the steps below to press the book down.

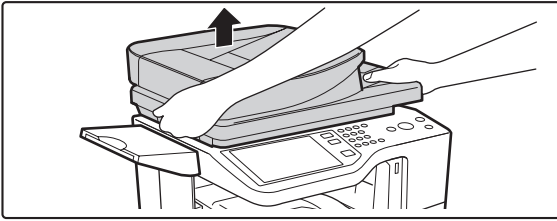

- (1) **Slightly lift the left and right sides of the automatic document feeder.**

The automatic document feeder will rise.

- (2) **Slowly close the automatic document feeder.**

### Caution

- **Close the automatic document feeder slowly. Abruptly closing the automatic document feeder may damage it.**
- **Take care that your fingers are not pinched when closing the automatic document feeder.**
- **Do not press hard on the automatic document feeder. This may cause failure.**

# PERIPHERAL DEVICES

This section describes the peripheral devices that can be used with the machine and explains how to use the finisher, as well as Sharp OSA (application communication module and external account module).

## PERIPHERAL DEVICES

Peripheral devices can be installed on the machine to increase its range of functionality.

The peripheral devices are generally optional, however, some models include certain peripheral devices as standard equipment.

(As of July, 2010)

Product name	Product number	Description
500-sheet paper feed unit	MX-CSX1	Additional tray. A maximum 500 sheets of paper can be loaded in each tray.
	MX-CSX2*	
Business card feeder	MX-BTX1	<b>MX-B402 only</b> This feeder attaches to the automatic document feeder and is used to automatically scan business cards.
Finisher	MX-FN12	Output device that enables the use of the staple function and offset function.
Barcode font kit	AR-PF1	Adds barcode fonts to the machine.
XPS expansion kit	MX-PUX1	The machine can be used as an XPS compatible printer. For details, consult your dealer. To install this kit, a 1 GB expansion memory board (MX-SMX3) is required.
Expansion memory board	MX-SMX3	This expands the memory that can be used on the machine.
Internet fax expansion kit	MX-FWX1	Enables Internet Fax.
Facsimile expansion kit	MX-FXX3	Adds a fax function.
Application integration module	MX-AMX1	The application integration module can be combined with the network scanner function to append a metadata file to a scanned image file.
Application communication module	MX-AMX2	This allows the machine to be linked over a network to an external software application. MX-B402SC is included as standard equipment.
External account module	MX-AMX3	This is required to use an external account application on the machine. MX-B402SC is included as standard equipment.



<b>Product name</b>	<b>Product number</b>	<b>Description</b>
Sharpdesk 1 license kit	MX-USX1	This software enables integrated management of documents and computer files.
Sharpdesk 5 license kit	MX-USX5	
Sharpdesk 10 license kit	MX-US10	
Sharpdesk 50 license kit	MX-US50	
Sharpdesk 100 license kit	MX-USA0	

\* Can be installed on the MX-CSX1.

# FINISHER

The finisher is equipped with the offset function, which offsets each set of output from the previous set. In addition, each set of sorted output can be stapled.

## PART NAMES

The following parts can be accessed when the finisher is open.

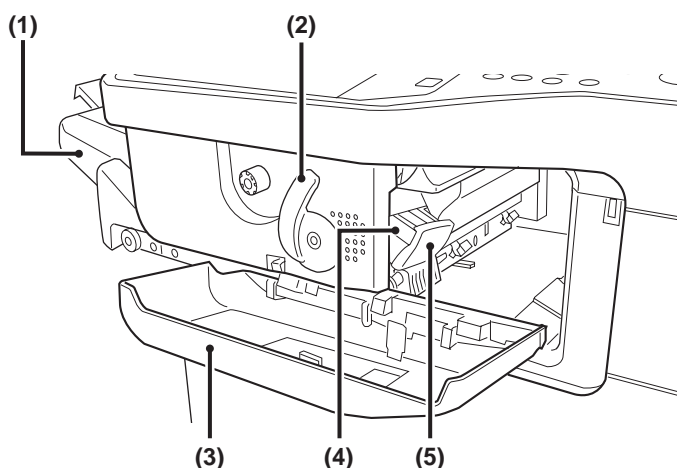

**(1) Output tray**

Stapled and offset output is delivered to this tray. The tray is slidable. Extend the tray for large output (8-1/2" x 14", 8-1/2" x 13", 8-1/2" x 13-1/2", and 8-1/2" x 13-2/5" sizes).

**(2) Lever**

Use this to move the finisher in order to remove a paper misfeed, replace staples, or remove a staple jam.

**(3) Front cover**

Open this cover to remove a paper misfeed, replace staples, or remove a staple jam.

**(4) Staple case**

This holds the staple cartridge. Pull the case out to replace the staple cartridge or remove a staple jam.

**(5) Staple case release lever**

Use this to remove the staple case.



Use caution when you turn on the power and when printing is taking place, as the tray may move up and down.

## SUPPLIES

The finisher requires the following staple cartridge:

Staple cartridge

(approx. 5000 staples per cartridge x 3 cartridges)

MX-SCX1

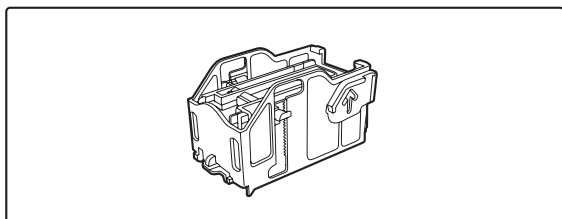

# FINISHER SPECIFICATIONS

Model	MX-FN12	
Paper sizes	8-1/2" x 14", 8-1/2" x 13-1/2", 8-1/2" x 13-2/5", 8-1/2" x 13", 8-1/2" x 11", 7-1/4" x 10-1/2", 5-1/2" x 8-1/2", envelopes, A4, B5, A5, 16K	
Paper weight	Thin paper (15 lbs. to 16 lbs. (55 g/m <sup>2</sup> to 59 g/m <sup>2</sup> )), plain paper (16 lbs. to 28 lbs. (60 g/m <sup>2</sup> to 105 g/m <sup>2</sup> )), heavy paper (28 lbs. bond to 110 lbs. index (106 g/m <sup>2</sup> to 209 g/m <sup>2</sup> ))	
Modes	Non-sort, offset sort, staple sort	
Allowed paper sizes for offset	8-1/2" x 14", 8-1/2" x 13-1/2", 8-1/2" x 13-2/5", 8-1/2" x 13", 8-1/2" x 11", 7-1/4" x 10-1/2", A4, B5, 16K	
Offset distance	1" (25 mm)	
Tray capacity* <sup>1</sup>	Non-stapling* <sup>2</sup> : 280 sheets (20 lbs. to 24 lbs. (75 g/m <sup>2</sup> to 90 g/m <sup>2</sup> )) (8-1/2" x 14", 8-1/2" x 13-1/2", 8-1/2" x 13-2/5", 8-1/2" x 13", 8-1/2" x 11", 7-1/4" x 10-1/2", A4, B5, 16K) 150 sheets (20 lbs. to 24 lbs. (75 g/m <sup>2</sup> to 90 g/m <sup>2</sup> )) (5-1/2" x 8-1/2", A5)	Stapling* <sup>3</sup> : 1 to 10 sheets per set: 30 sets 11 to 30 sheets per set: 10 sets (8-1/2" x 14", 8-1/2" x 13-1/2", 8-1/2" x 13-2/5", 8-1/2" x 13", 8-1/2" x 11", 7-1/4" x 10-1/2", A4, B5, 16K)
Power supply	Supplied from the machine	
Dimensions	When tray is folded up: 18-45/64" (W) x 13-7/64" (D) x 6-7/32" (H) (475 mm (W) x 333 mm (D) x 158 mm (H)) When tray is extended: 20-19/32" (W) x 13-7/64" (D) x 6-7/32" (H) (523 mm (W) x 333 mm (D) x 158 mm (H))	
Weight	Approx. 19.8 lbs. (9 kg)	
Stapler section		
Allowed paper sizes for stapling	8-1/2" x 14", 8-1/2" x 13-1/2", 8-1/2" x 13-2/5", 8-1/2" x 13", 8-1/2" x 11", 7-1/4" x 10-1/2", A4, B5, 16K (Stapling at one position at front of paper.)	
Maximum number of sheets for stapling* <sup>3</sup>	30 sheets	

\*<sup>1</sup> The maximum number of sheets that can be held varies depending on ambient conditions in the installation location, the type of paper, and the storage conditions of the paper.

\*<sup>2</sup> Up to 20 envelopes can be output.

\*<sup>3</sup> The maximum number of sheets for stapling assumes a paper weight of 24 lbs. (90 g/m<sup>2</sup>) and includes two cover sheets of 28 lbs. bond to 110 lbs. index (106 g/m<sup>2</sup> to 209 g/m<sup>2</sup>).



Special media such as transparency film and label sheets cannot be stapled.

# BUSINESS CARD FEEDER

This feeder attaches to the automatic document feeder and is used to automatically scan business cards.

**MX-B402 only**

1

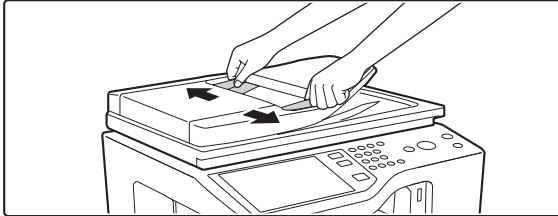

Open the original guide to the maximum width.

2

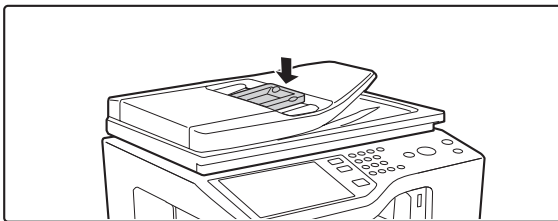

Place the business card feeder on the document feeder tray.

- (1) Place the business card feeder in the center of the document feeder tray.
- (2) Gently press down on the business card feeder.

You will hear the feeder click into place.



- When you have attached the business card feeder, enable "Business Card Scan Option" in the system settings (administrator).
- When scanning business cards, it is convenient to use "Business Card Scan" in the special modes for copying and scanning.

3

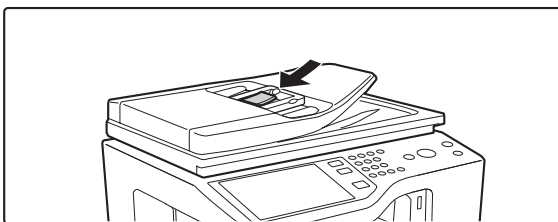

Load the business cards.

Make sure the edges of the cards are aligned evenly. Insert the cards face up all the way into the business card feeder.

4

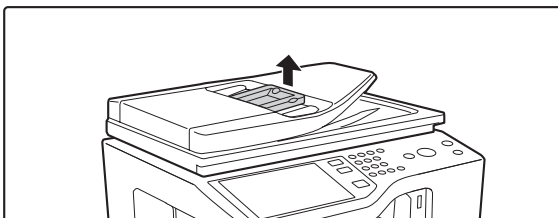

After using the business card feeder, lift the feeder to remove it.

You will hear a click sound as the feeder is released. Store the feeder in its storage pocket.



**System Settings (Administrator): Business Card Scan Option**  
Specify whether or not the **Business Card Scan** function is used.

## Business card feeder specifications

<b>Model</b>		MX-BTX1
<b>Business card*</b>	<b>Sizes</b>	2" x 3-1/2" to 2-11/64" x 3-19/32" (51 mm x 89 mm to 55 mm x 91 mm)
	<b>Thickness</b>	0.004" to 0.008" (0.1 mm to 0.2 mm)
<b>Scanning</b>		Single-sided (face-up)
<b>Capacity</b>		Stack height 9/64" (3.5 mm) maximum
<b>Dimensions</b>		4-17/32" (W) x 3-15/32" (D) x 63/64" (H) (115 mm (W) x 88 mm (D) x 25 mm (H))
<b>Weight</b>		Approx. 0.09 lbs. (40 g)

\* Device may be unable to correctly feed and scan the business card depending on the business card's condition, material, form, and fabrication method.

# SHARP OSA

Sharp OSA (Open Systems Architecture) is an architecture that enables external applications to be directly connected to a digital multifunction machine over a network.

When a digital multifunction machine that supports Sharp OSA is used, the operation panel controls and functions of the machine such as scan send can be linked to an external application.

There are two types of external applications: "standard application" and "external account application". An "external account application" is used for centralized account management of a multifunction machine on a network. A "standard application" refers to all other applications.

## APPLICATION COMMUNICATION MODULE (MX-AMX2)

For model MX-B402SC, this is included as standard equipment.

When a previously registered standard application is selected in the Web pages of the machine, the machine retrieves the operation screen from the registered URL. Control of the operation screen is performed by the standard application, and Scan to FTP, Scan to Network Folder, and HTTPS transmission can be executed.

### Standard application setup

To enable a general application in the Web pages of the machine, click [Application Settings] in the administrator menu frame, and then [External Applications Settings] and [Standard Applications]. Configure settings for the standard application in the screen that appears.

### Selecting a standard application

The procedure for selecting a general application that has been enabled in the Web pages of the machine is explained below.

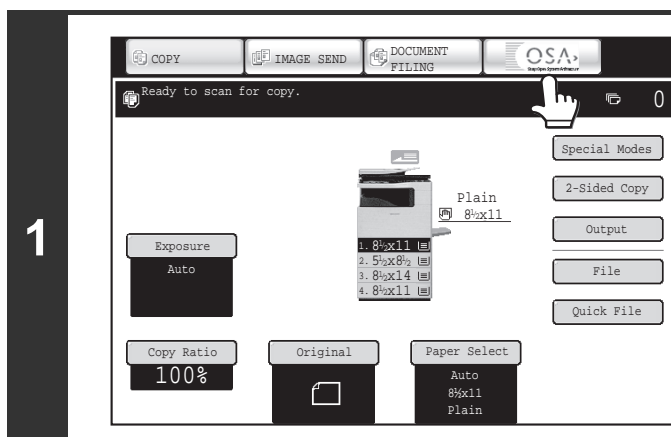

### Touch the [Sharp OSA] key in the mode select keys.

If no standard applications have been stored in the Web pages, the key cannot be touched.

2

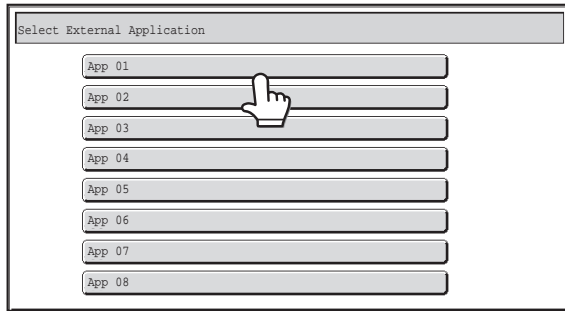

### Select the standard application.

If two or more standard applications have been stored in the Web pages, the screen to select the standard application will appear. Touch the standard application that you wish to use. If only one standard application has been stored in the Web pages, connection to the standard application will begin.

3

### The machine connects to the standard application.

The message "Connecting to the external application." appears while the machine communicates with the standard application.



The mode select key cannot be used during scanning.

## EXTERNAL ACCOUNT MODULE (MX-AMX3)

For model MX-B402SC, this is included as standard equipment.

An external account application can be used in "external authentication mode" or "external count mode". When external authentication mode is used, the login screen is retrieved from the application when the machine is started. When a job ends, a job notification screen is sent to the application to enable counts to be kept for each authenticated user.

When "external count mode" is used, the login screen is not displayed when the machine is started. Only a job result notification is sent to the application. User authentication by the external account application cannot be used, however, the external account application can be used in combination with the internal account function.

### External account application setup

To enable an external account application in the Web pages of the machine, click [Application Settings] in the administrator menu frame, and then [External Applications Settings] and [External Accounting]. Configure settings for the external account application in the screen that appears. The setting change will take effect after the machine is restarted. To restart the machine, see "[TURNING THE POWER ON AND OFF](#)" (page 1-15).

### Operation in external account mode

The two modes for using an external account application operate as explained below.

#### External authentication mode

When the [Enable Authentication by External Server] checkbox is selected in "External Account Setting" of "Sharp OSA Settings" in the system settings (administrator), the machine enters external authentication mode. When the machine is powered on in external authentication mode, the machine accesses the external account application and displays the login screen. The login screen also appears when the [Call] key is touched to run a job in the job status complete screen. (The login screen does not appear if the user has already logged in by the normal method.)

The [JOB STATUS] key can be pressed while the login screen appears to show the job status screen. To return to the previous state, press the mode select key.



- The user control function of the machine cannot be used in external authentication mode. However, "User Registration", "User Count Display", "User Count Reset", "User Information Print", and "The Number of User Name Displayed Setting" can be used.
- The mode select key cannot be used while the login screen appears.

### If login fails

If the login screen fails to appear or the application does not operate correctly, the machine may also stop operating correctly. In this event, it is recommended that you quit external account mode from the Web pages of the machine. For more information, see [Help] in the Web pages.

If it is necessary to forcibly terminate external account mode using the operation panel of the machine, follow the steps below.

Press the [SYSTEM SETTINGS] key and change "External Account Setting" in the system settings (administrator). The setting change will take effect after the machine is restarted. To restart the machine, see "[TURNING THE POWER ON AND OFF](#)" (page 1-15).

### External count mode

When only the [External Account Control] setting is enabled in "External Account Setting" of "Sharp OSA Settings" in the system settings (administrator), the machine enters external count mode.

Unlike external authentication mode, when the machine is started in "external count mode", the login screen of the external account application is not displayed. Only the job result is sent to the external account application. External count mode can be used together with the user control function of the machine. (External count mode can also be used when the user control function is disabled.)



# REPLACING SUPPLIES AND MAINTENANCE

This section explains the procedures for replacing supplies such as toner and staple cartridges and routine maintenance.

## REPLACING THE TONER CARTRIDGES

Be sure to replace the toner cartridge when the message "Change the toner cartridge." appears.

### In copy mode

Ready to scan for copy.  
(Prepare a new one.)

When this message appears, replace the toner cartridge.



If you continue to use the toner cartridge without replacing it, the message below will appear. When this message appears, printing will not be possible until the toner cartridge is replaced.

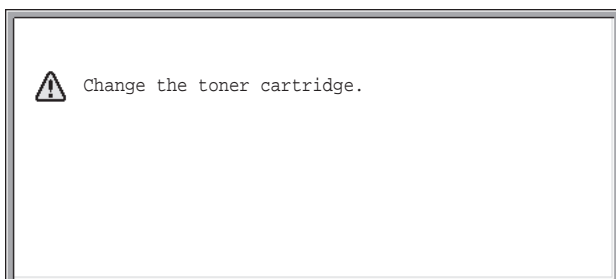

 To view the approximate amount of toner remaining, continually touch the [COPY] key during printing or when the machine is idle. The percentage of toner remaining will appear in the display while the key is touched. When the percentage falls to "25-0%", obtain a new toner cartridge and keep it ready for replacement.

1

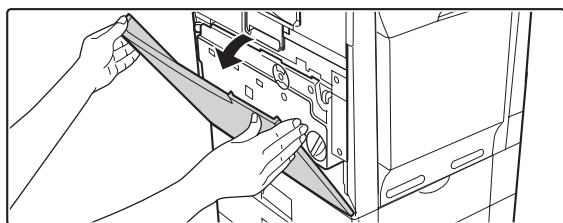

Open the front cover.

2

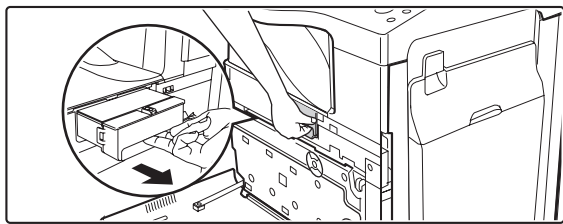

**Pull the toner cartridge toward you.**

3

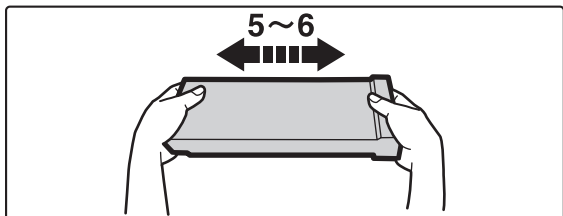

**Take out the new toner cartridge, hold it with both hands, and shake 5 or 6 times horizontally.**



- When shaking the toner cartridge, be sure to shake with the protective material inserted in the cartridge. If you shake the cartridge after removing the protective material, toner may spill out.
- Shake the toner cartridge only in the horizontal direction. If shaken in any other direction, toner may collect in one part of the cartridge.

4

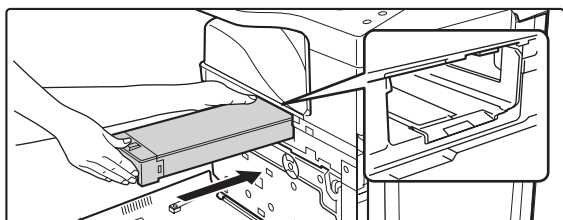

**Insert the new toner cartridge horizontally and push it firmly in.**

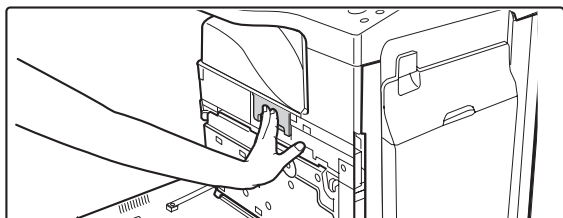

5

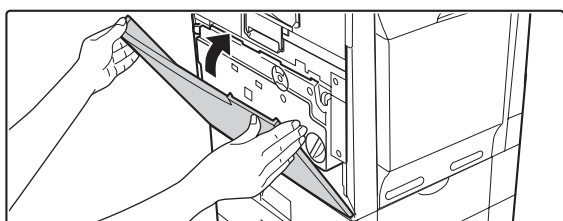

**Close the front cover.**



- After the toner cartridge is replaced, the machine automatically enters image adjustment mode. Image adjustment will not take place if the cover is not closed.
- Take care that your fingers are not pinched when closing the cover.

### **⚠ Caution**

- Do not throw a toner cartridge into a fire. Toner may fly and cause burns.
- Store toner cartridges out of the reach of small children.



- Store the box that contains the toner cartridge horizontally; do not store it standing up. If the toner cartridge is stored standing up, the toner may solidify inside the cartridge.  
Store the toner in a location that is cooler than 104°F (40°C). Storage in a hot location may cause the toner in the cartridge to solidify.
- If a toner cartridge other than a SHARP-recommended toner cartridge is used, the machine may not attain full quality and performance and there is a risk of damage to the machine. Be sure to use a SHARP-recommended toner cartridge.



- Keep the used toner cartridge in a plastic bag (do not discard it). Your service technician will collect the used toner cartridge.
- To view the approximate amount of toner remaining, continually touch the [COPY] key during printing or when the machine is idle. The percentage of toner remaining will appear in the display while the key is touched. When the percentage falls to "25-0%", obtain a new toner cartridge and keep it ready for replacement. When the remaining toner falls to "25-0%", output images may be faint or partially missing when an original or image with dark colors is copied or printed.

Total Count	00,000,000
Toner Quantity	100-75%

---

---

# REPLACING THE TONER COLLECTION CONTAINER

The toner collection container collects excess toner that is produced during printing. When the toner collection container becomes full, "Replace used toner container." will appear. Follow the procedure below to replace the toner collection container.

It is also necessary to remove the toner collection container in order to replace the transfer unit. Refer to the procedure below to remove the toner collection container when replacing the transfer unit.

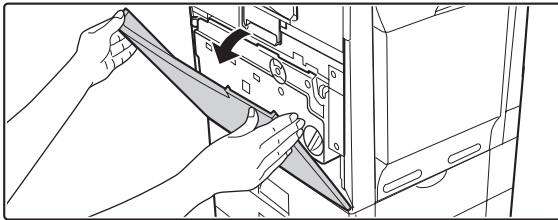

Toner may spill when the toner collection container is replaced. Before replacing the toner collection container, take measures such as placing covers on and around the machine to prevent soiling.

**1**

**Open the front cover.**

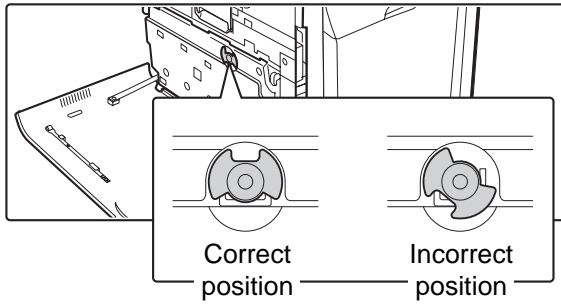

## Release the used toner collection container.

- (1) **Make sure that the part indicated in the illustration has stopped in the correct position.**

After machine operation stops suddenly due to a power outage or other reason, the part will stop in the correct position unless an attempt was made to remove the toner collection container.

If the part has not stopped in the correct position, close the front cover, turn on the power, and then follow the correct procedure to turn off the power. After the power has been turned off correctly, start again from step 1.

2

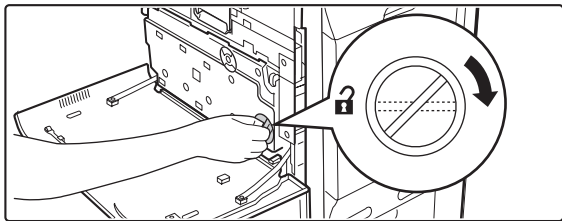

- (2) **Turn the toner collection container lock lever to the right until it is horizontal.**

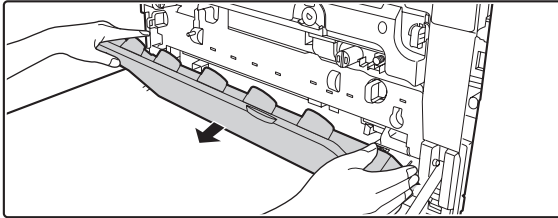

- (3) **Tip the toner collection container forward.**

Grasp the top right of the toner collection container with your right hand and support the bottom left with your left hand, and slowly tip the container toward you.

3

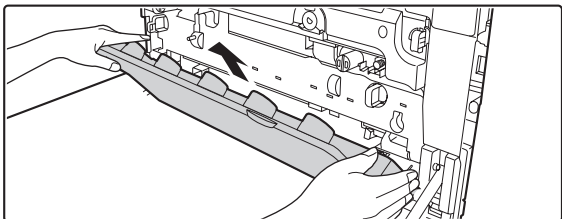

## Remove the toner collection container.



- If the toner collection container is tipped forward too far, it will not be possible to remove it.
- Do not point the holes down as used toner will spill out.



- Hold the container by both hands and lift it up slowly.
- Do not discard the toner collection container. Place it in a plastic bag and keep it until your service technician comes to perform maintenance. Your service technician will collect the toner collection container.

4

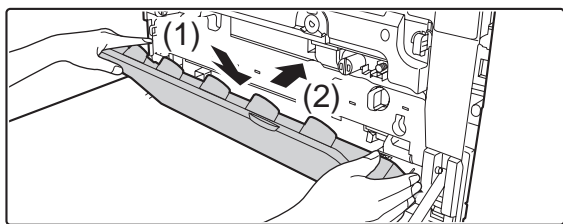

### Install the new toner collection container.

Insert the container from above at a slant. (The direction opposite to when you removed it.)

5

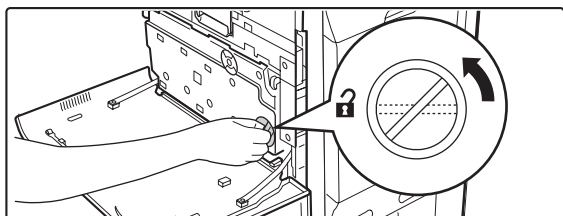

### Turn the lock lever on the toner collection container to the left.

Turn the lock lever to the left until it stops.



If the lock lever does not turn, check if the toner collection container is installed correctly. In particular, make sure that the top left corner of the toner collection container is correctly in place.

6

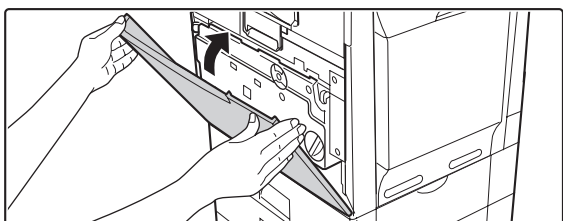

### Close the front cover.



Take care that your fingers are not pinched when closing the cover.

### Caution

- Do not throw the toner collection container into a fire. Toner may fly and cause burns.
- Store the toner collection container out of the reach of small children.



- Toner may spill when the toner collection container is replaced. Take measures so that there will be no problem if toner spills on the machine, around the machine, or on your clothes.
- Do not touch the part soiled with toner of the removed toner collection container. If you accidentally touch the toner, immediately wash your hands.

# REPLACING THE STAPLE CARTRIDGE IN THE FINISHER

When the staple cartridge runs out of staples, a message will appear in the operation panel. Follow the procedure below to replace the staple cartridge.

1

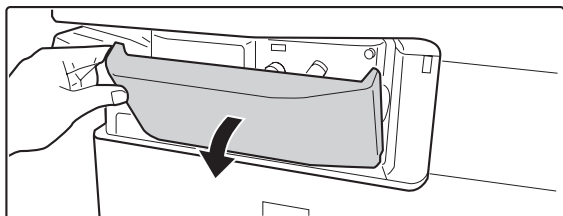

Open the cover.

2

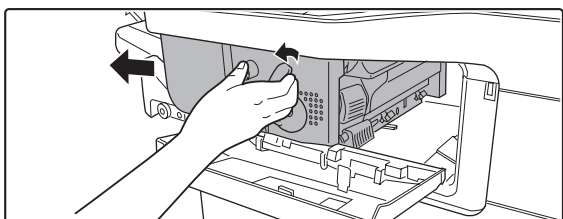

While pressing the lever over to the left, slide the finisher to the left until it stops.

Gently slide the finisher until it stops

3

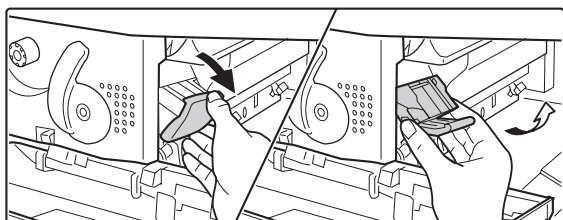

Lower the staple case release lever and remove the staple case.

Pull the staple case out to the right.

4

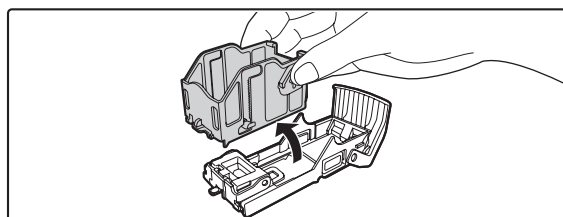

Remove the empty staple cartridge from the staple case.

Gently grasp the right side of the staple cartridge as shown and lift to the left and up. The lock will release easily. After the lock releases, continue lifting the staple cartridge to the left and up to remove it.



- Even when a message appears in the operation panel, staples may occasionally remain in the staple cartridge.
- If staples remain, the lock will not release easily. Forcing the lock to release may deform the staple case and staple cartridge, causing failure.

5

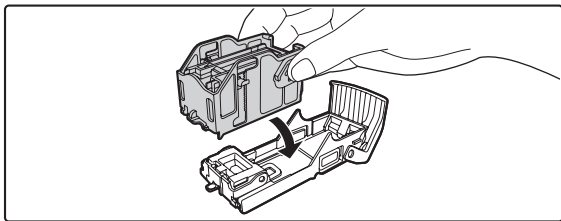

### Insert a new staple cartridge into the staple case as shown.

Push the staple cartridge in until it clicks into place.

6

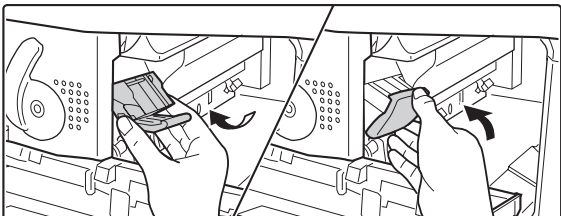

### Replace the staple case.

Push the staple case in until it clicks into place.

7

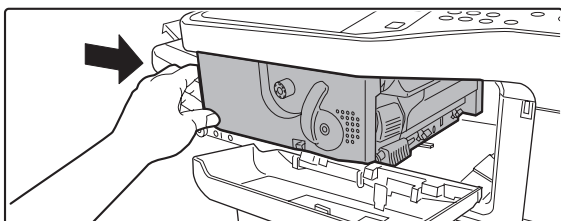

### Slide the finisher back to the right.

Gently slide the finisher back to the right until it locks into its original position.

8

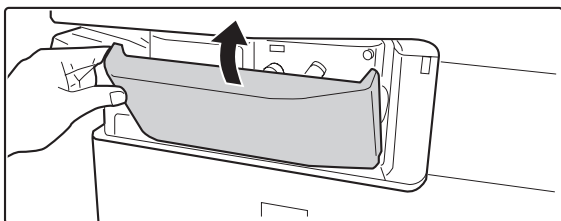

### Close the cover.



Take care that your fingers are not pinched when closing the cover.



Make a test print or copy in staple sort mode to verify that stapling takes place correctly.



---

---

# REGULAR MAINTENANCE

To ensure that the machine continues to provide top quality performance, periodically clean the machine.

## Warning

**Do not use a flammable spray to clean the machine. If gas from the spray comes in contact with hot electrical components or the fusing unit inside the machine, fire or electrical shock may result.**



- Do not use thinner, benzene, or similar volatile cleaning agents to clean the machine. These may degrade or discolor the housing.
- Use a soft cloth to gently wipe off dirt from the area on the operation panel with a mirror-like finish (shown at right). If you use a stiff cloth or rub hard, the surface may be damaged.

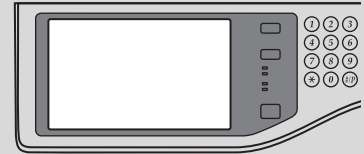

The area with a mirror-like finish is the area that is .

# CLEANING THE DOCUMENT GLASS AND AUTOMATIC DOCUMENT FEEDER

If the document glass or document backplate sheet becomes dirty, the dirt will appear as dirty spots, or black or white lines in the scanned image. Always keep these “parts clean.

Wipe the parts with a clean, soft cloth.

If necessary, moisten the cloth with water or a small amount of neutral detergent. After wiping with the moistened cloth, wipe the parts dry with a clean dry cloth.

## Document glass

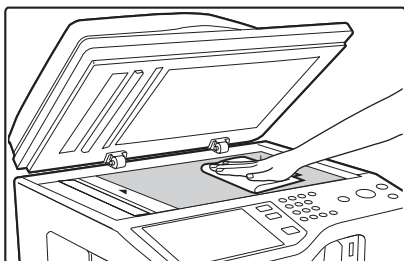

## Document backplate sheet

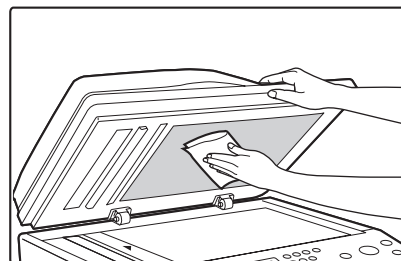

**!** When wiping dirt off the machine, do not press down hard on the machine. This may damage or deform the machine.

## Scanning area

Before using the automatic document feeder, please clean the glass surface with the provided glass cleaner.

If dirt on the glass cannot be removed, wipe it off using a soft cloth moistened with water or a neutral detergent, then wipe it dry with a dry cloth.

Dirt streaks may appear on copies caused by dirty glass in the scanning area.

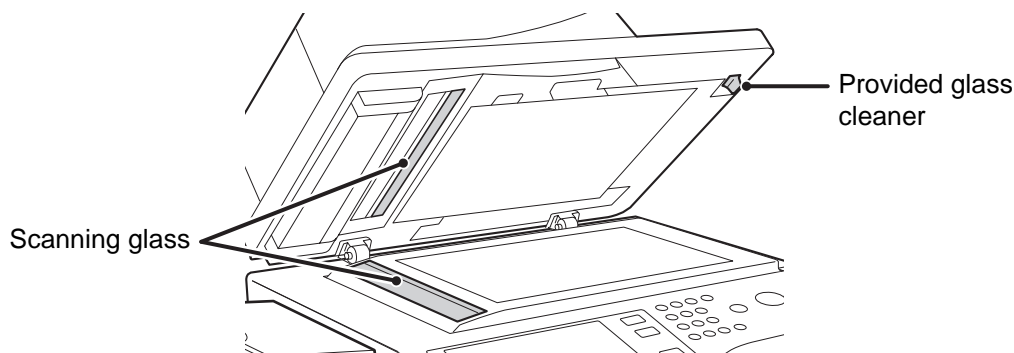

**!** The glass cleaner is only provided on the MX-B402SC.

---

---

# CLEANING THE MAIN CHARGER OF THE PHOTOCONDUCTIVE DRUM

If black or white lines appear even after you have cleaned the document glass and automatic document feeder, use the charger cleaner to clean the main charger.

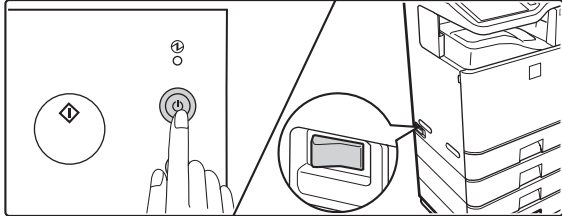
**1**

Press the [POWER] key (⏻) on the operation panel to turn off the panel power, and then switch the main power switch to the off position.

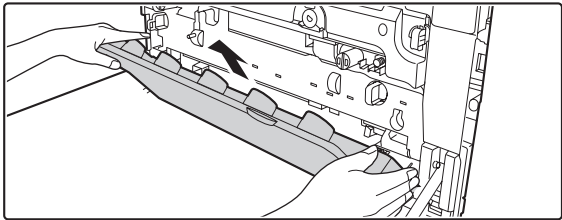
**2**

Open the front cover and remove the toner collection container.

➔ [REPLACING THE TONER COLLECTION CONTAINER](#) (page 1-55)

3

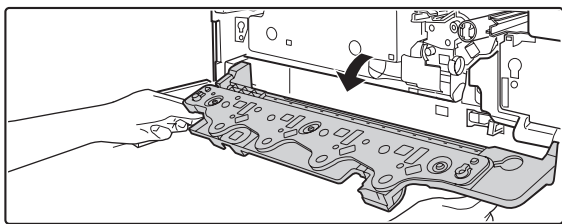

**Release the lock levers and open the main charger cover.**

➔ [REPLACING THE TONER CARTRIDGES](#) (page 1-52)

4

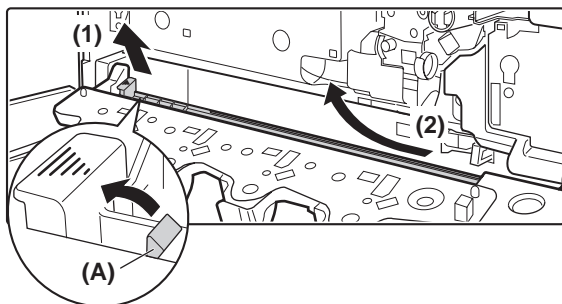

**Remove the charger cleaner.**

- (1) Flip down the charger cleaner lock (A) in the direction of the arrow, and lift the left end of the charger cleaner.
- (2) Move the charger cleaner to the left and pull it out.

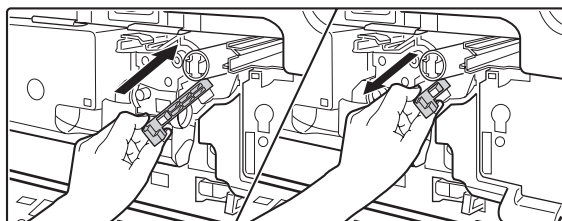

**Clean the main charger.**

- (1) Gently push the charger cleaner all the way in.
- (2) Gently pull the charger cleaner out.
- (3) Repeat the above (1) to (2) three times.

5



- Take care not to let the tip of the charger cleaner become soiled by toner.
- Clean with the mark (≡) on the charger cleaner facing down.
- Holes to be cleaned by the charger cleaner are indicated by labels similar to (A).

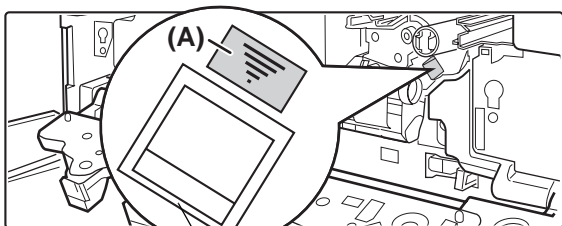

Position of mark

- Do not use the charger cleaner for any purpose other than cleaning the main charger.

6

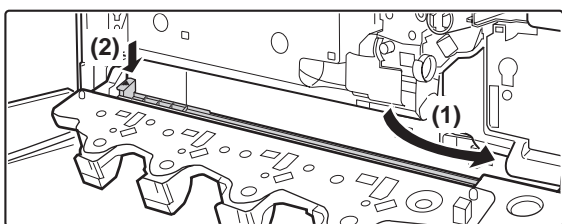

**Replace the charger cleaner in its original position.**

Insert the tip of the charger cleaner in toward the right and then press down on the end of the charger cleaner. The charger cleaner will lock into place.

7

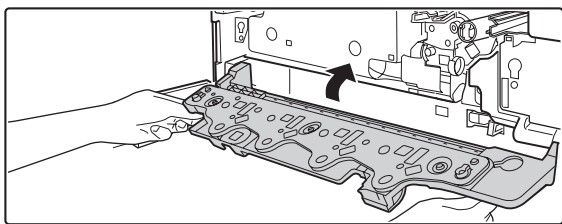

**Close the main charger cover and rotate the lock levers in the direction of the arrows to lock the cover.**

➤ [REPLACING THE TONER CARTRIDGES](#) (page 1-52)

8

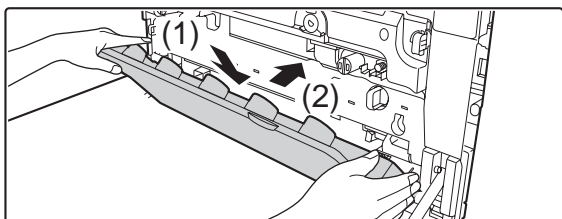

**Install the toner collection container.**

➤ [REPLACING THE TONER COLLECTION CONTAINER](#) (page 1-55)

9

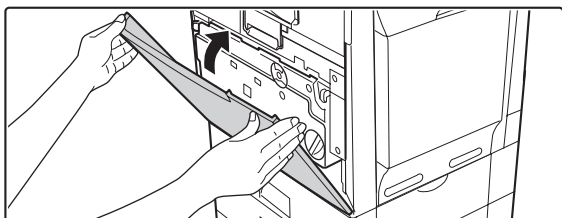

**Close the front cover.**



Take care that your fingers are not pinched when closing the cover.

10

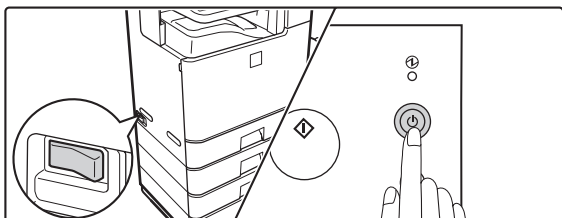

**Turn on the power.**

Switch the main power switch "ON" and press the [POWER] key (⏻) on the operation panel to turn on the operation panel power.

# CLEANING THE BYPASS TRAY ROLLERS

If you find that paper fed from the bypass tray misfeeds or is soiled by the roller, remove and clean the roller. If misfeeds or soiling continue to occur, replace the roller.

Before starting, remove the paper from the bypass tray.

1

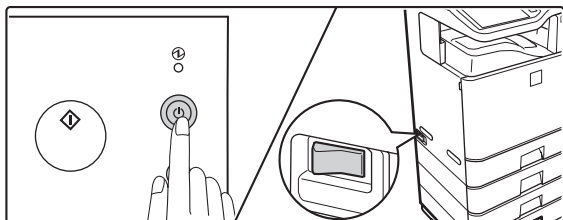

Press the [POWER] key (⏻) on the operation panel to turn off the panel power, and then switch the main power switch to the off position.

2

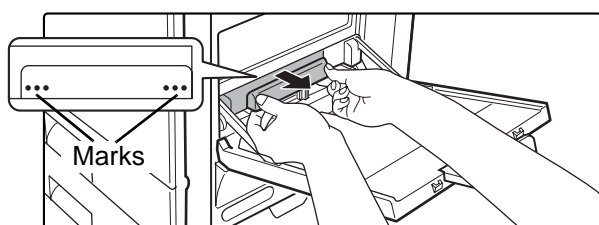

Remove the roller cover from the bypass tray.

Place your fingers behind the ... marks on the roller cover and pull straight toward you.

3

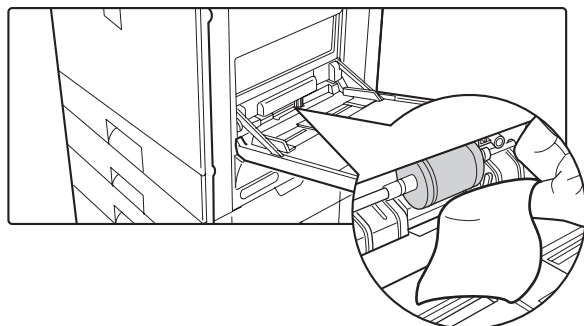

To clean the rollers, wipe each roller with a clean cloth.

## ⚠ Caution

When cleaning the rollers, be careful not to injure your hands.



Do not touch the surface of the roller if your hands are dirty.



- When you replace roller, go to the next step.
- If the dirt is difficult to remove, moisten the cloth with a small amount of water or neutral detergent, and then wipe with a clean, dry cloth until no moisture remains.

4

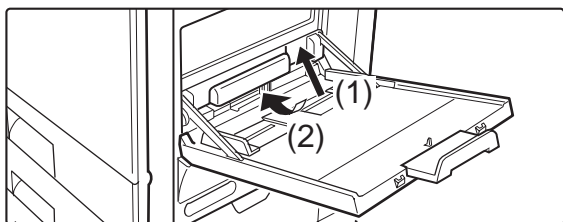

Attach the roller cover on the bypass tray.

- (1) Tilt the front of the cover slightly to attach it.
- (2) Press the cover onto the bypass tray so that it locks into place.

5

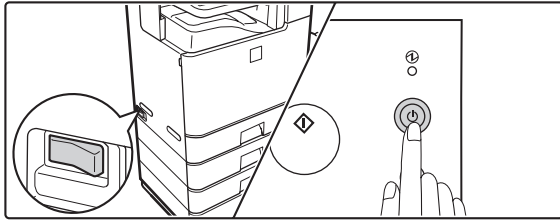
**Turn on the power.**

Switch the main power switch "ON" and press the [POWER] key (⏻) on the operation panel to turn on the operation panel power.

# CLEANING THE AUTOMATIC DOCUMENT FEEDER ROLLERS

If you find that originals fed through the automatic document feeder misfeed or are soiled by the rollers, remove the rollers and clean them. If misfeeds or soiling continue to occur, replace the rollers.

Before starting, remove any originals from the automatic document feeder.

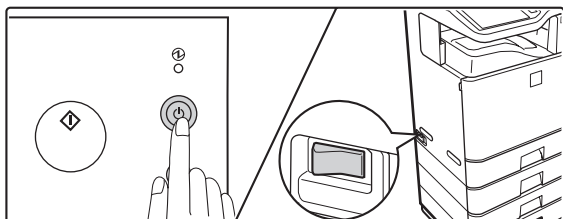
**1**

Press the [POWER] key (⏻) on the operation panel to turn off the panel power, and then switch the main power switch to the off position.

**2**

When using the MX-B402

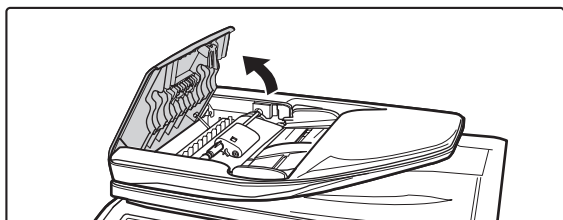

When using the MX-B402SC

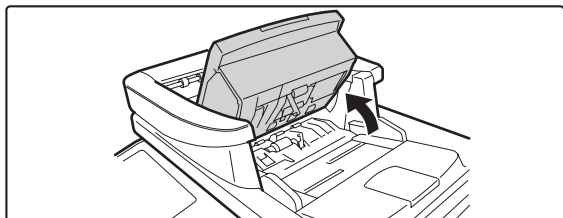

Open the document conveyor cover on the automatic document feeder.



3

When using the MX-B402

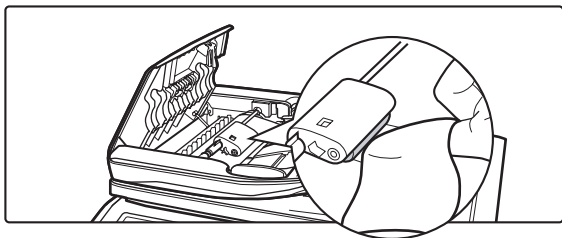

To clean the removed rollers, wipe each roller with a clean cloth.

When using the MX-B402SC

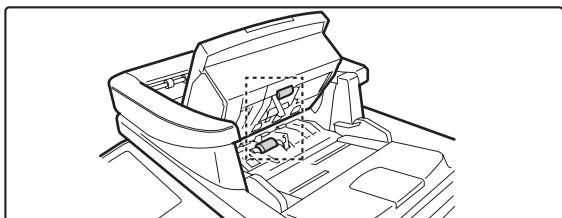

### ⚠ Caution

When cleaning the rollers, be careful not to injure your hands.



Do not touch the surface of the roller if your hands are dirty.



- If the dirt is difficult to remove, moisten the cloth with water or a neutral detergent. After wiping, wipe the roller dry with a clean cloth and go to the step 10.
- When you replace roller, go to the next step.

4

When using the MX-B402

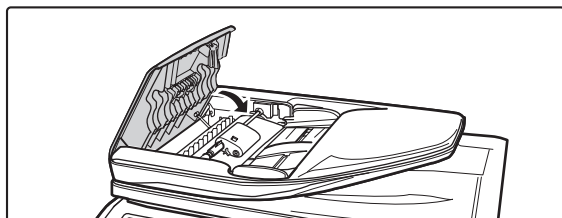

Close the document conveyor cover on the automatic document feeder.

When using the MX-B402SC

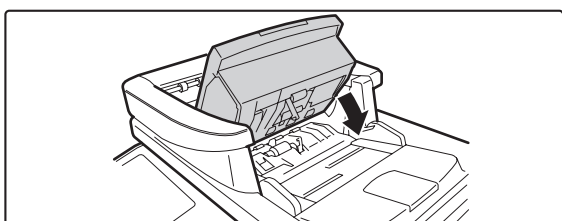

Take care that your fingers are not pinched when closing the cover.

5

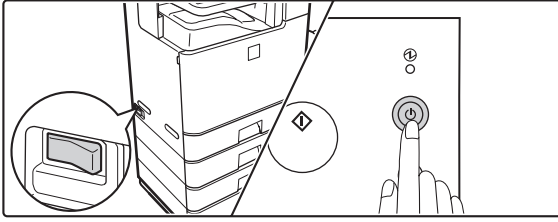
**Turn on the power.**

Switch the main power switch "ON" and press the [POWER] key (⏻) on the operation panel to turn on the operation panel power.



After turning on the power, make sure that an error message regarding replacement of the roller does not appear.

# CLEANING THE LASER UNIT

When the laser unit inside the machine becomes dirty, line patterns may form in the printed image. Follow the steps below to clean the laser unit.



## Identifying white lines caused by a dirty laser unit

- White lines always appear in the same place.
- The white lines are parallel to the direction of paper feeding.



White line

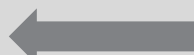

Direction of paper feeding

- White lines appear not only on copies but also on print jobs from a computer. (The same lines appear on both copies and print jobs.)

1

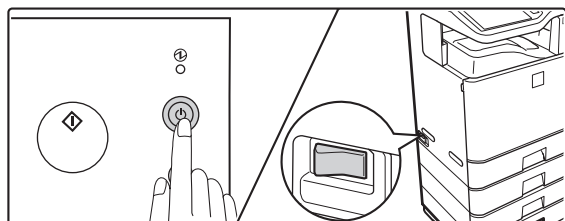

Press the [POWER] key (⏻) on the operation panel to turn off the panel power, and then switch the main power switch to the off position.

2

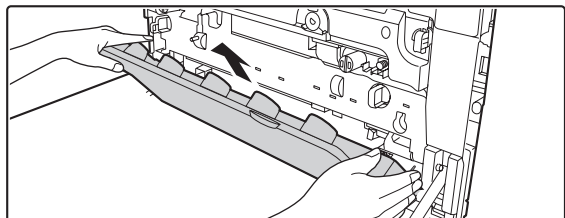

Open the front cover and remove the toner collection container.

➔ [REPLACING THE TONER COLLECTION CONTAINER](#) (page 1-55)

3

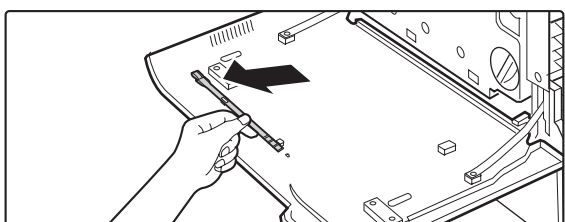

Remove the cleaning tool for the writing unit from the front cover.

4

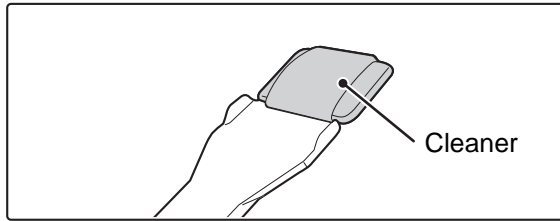

**Make sure that the cleaner at the tip of the cleaning tool is not dirty.**



If the cleaner is dirty, remove the cleaner and replace it with a clean one. For the procedure for replacing the cleaner, see steps 5 through 7. If the cleaner is not dirty, go to step 8.

5

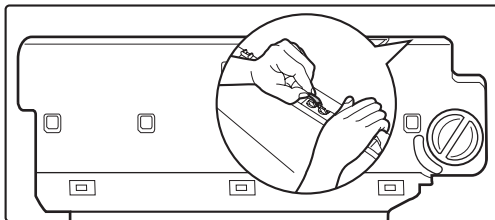

**Pull out the replacement cleaner from the toner collection container.**

6

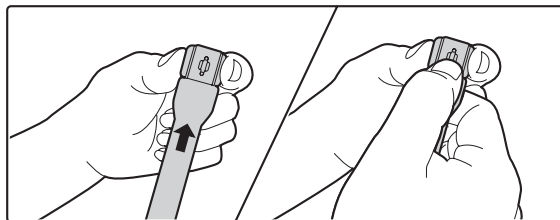

**Remove the dirty cleaner.**

Firmly grasp the tool close to where the cleaner is attached. Use your other hand to press down on the hook that secures the cleaner and remove the cleaner.



Return the removed cleaner to the toner collection container.

7

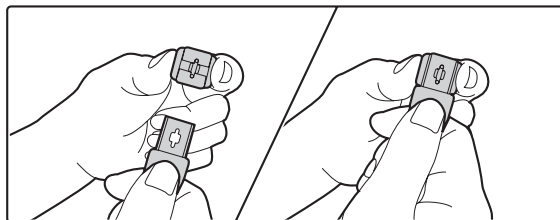

**Attach the new cleaner to the cleaning tool.**

Align the cleaner hook with the attachment hole in the cleaning tool. Hold the cleaner firmly and push the cleaning tool into the cleaner.



Make sure that the cleaner is firmly attached to the cleaning tool.

8

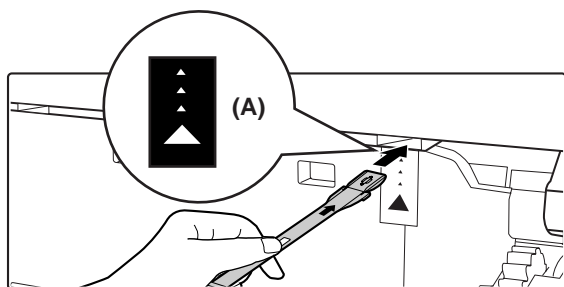

### Clean the laser unit.

- (1) **Point the cleaner down and slowly insert the tool into the hole that you wish to clean.**

The parts of the writing unit that require cleaning are indicated by labels similar to (A).

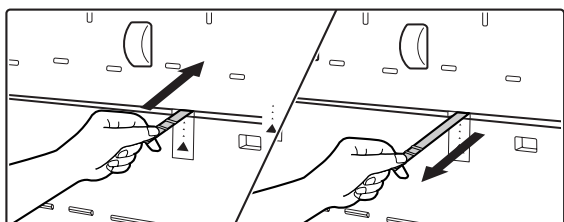

- (2) **Insert the cleaning tool all the way into the hole and then pull it back out.**

Pull the cleaning tool out until you feel the tip of the tool leave the cleaning surface of the laser unit.

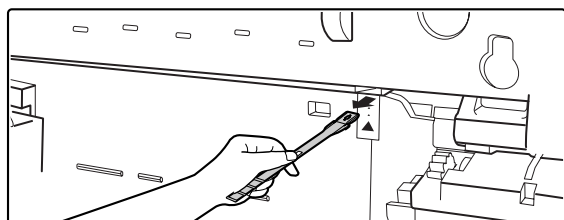

- (3) **Repeat step (2) two or three times and then remove the cleaning tool.**

9

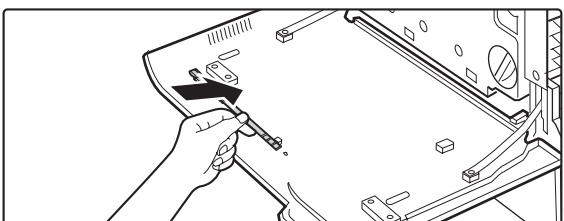

### Replace the cleaning tool.

10

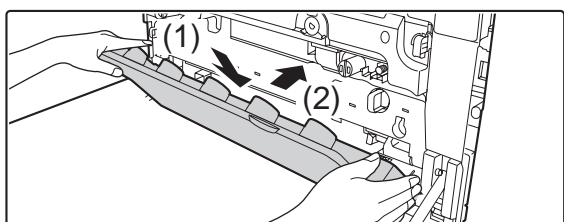

### Install the toner collection container.

- ➔ [REPLACING THE TONER COLLECTION CONTAINER](#) (page 1-55)

11

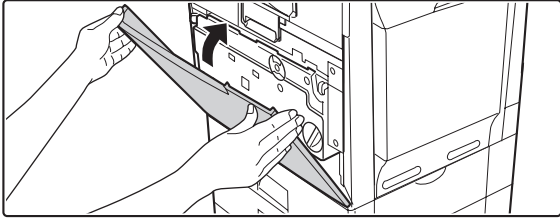
**Close the front cover.**

Take care that your fingers are not pinched when closing the cover.

12

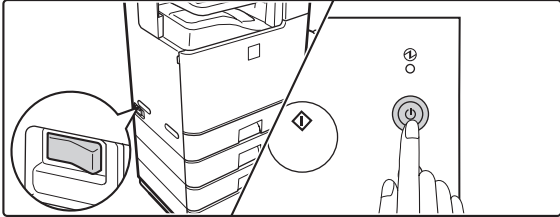
**Turn on the power.**

Switch the main power switch "ON" and press the [POWER] key (⏻) on the operation panel to turn on the operation panel power.

# CLEANING THE PT CHARGER OF THE PRIMARY TRANSFER BELT UNIT

If black or white lines still remain after the document glass / automatic document feeder and main charger have been cleaned, use the PT charger cleaner to clean the PT charger.

1

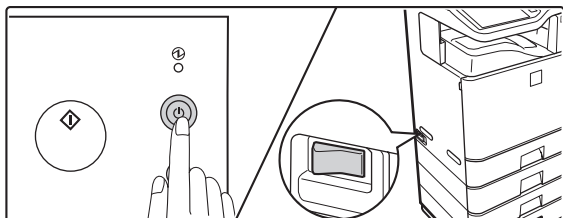

Press the [POWER] key (⏻) on the operation panel to turn off the panel power, and then switch the main power switch to the off position.

2

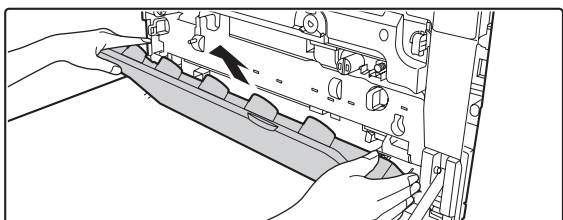

Open the front cover and remove the toner collection container.

➤ [REPLACING THE TONER COLLECTION CONTAINER](#) (page 1-55)

3

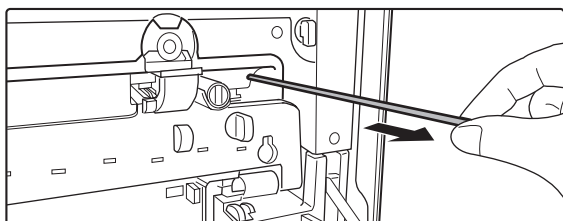

Clean the PT charger.

(1) Slowly pull the PT charger cleaner out until you feel a slight resistance.

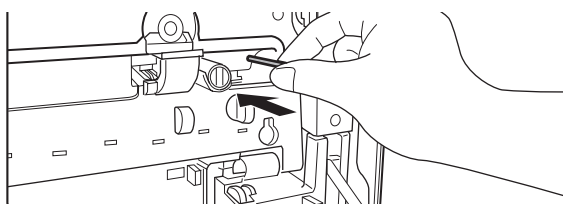

(2) Slowly push the PT charger cleaner back in.

(3) Repeat the above (1) to (2) three times.

4

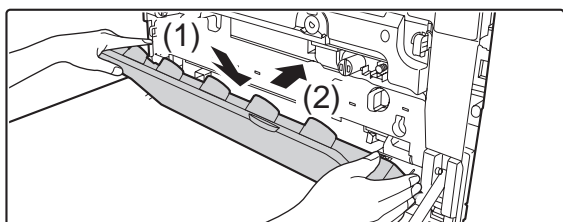

Install the toner collection container.

➤ [REPLACING THE TONER COLLECTION CONTAINER](#) (page 1-55)

5

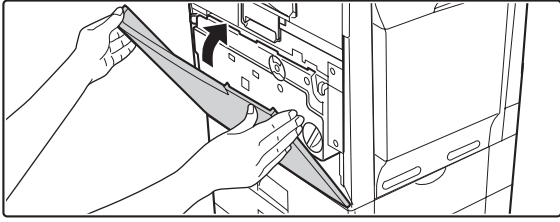
**Close the front cover.**

Take care that your fingers are not pinched when closing the cover.

6

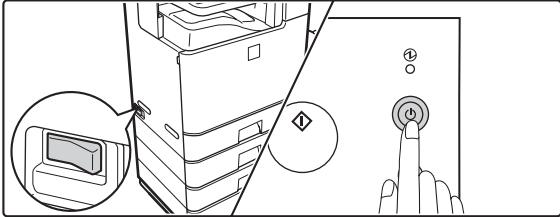
**Turn on the power.**











Switch the main power switch "ON" and press the [POWER] key (⏻) on the operation panel to turn on the operation panel power.



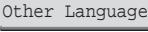





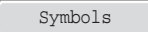
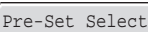

# ENTERING TEXT

This section explains the text entry screen.

## FUNCTIONS OF THE MAIN KEYS

Key	Description
	This key changes the text entry screen from the lower case screen to the upper case screen. The upper case screen will continue to appear until the [Caps] key is touched again so that it is no longer highlighted. The [Caps] key is convenient when you wish to enter all capital letters.
	This key temporarily changes the keys in the text entry screen to upper case when lower case letters appear, or to lower case when upper case letters appear. Touch a letter key after touching the [Shift] key to enter that letter. After the letter is entered, the [Shift] key will no longer be highlighted and the original text entry screen will appear. The [Shift] key is convenient when you only need to enter one upper case letter or one lower case letter, or when you need to enter one of the symbols assigned to the numeric keys. To cancel selection of the [Shift] key, touch the [Shift] key again. The [Shift] key will no longer be highlighted.
	Touch this key to enter a line break when entering the body text of an e-mail message.
	Touch this key to delete the characters to the left of the cursor one character at a time.
	Touch this key to temporarily change the key layout of character entry mode to a different language. Select the key layout that you wish to use.
	Touch this key to enter a space between letters.
	This key temporarily changes the entry screen to the accented letter and symbol entry screen. Touch a letter key after touching the [AltGr] key to enter that letter. After the letter is entered, the [AltGr] key will no longer be highlighted and the original text entry screen will appear. To cancel selection of the [AltGr] key, touch the [AltGr] key again. The [AltGr] key will no longer be highlighted.
	These keys move the cursor left and right.
	These keys move the cursor to the line above or below the current line during entry of the body text of an e-mail message.
	Touch this key to select character entry mode.
	Touch this key to select symbol entry mode. Symbol mode is used to enter symbols and accented letters.
	Use this key to retrieve a previously stored subject for e-mail or other pre-set text.

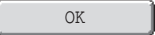
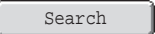
Key	Description
	Shows explanations of each key.
     	Use this key to enter a previously stored text string such as ".com". Text strings are stored in "Soft Keyboard Template Setting" in "Operation Setting" in the "System Settings" on the Web page.
	Touch this key to return to the previous setting screen without entering text.
	Touch this key to enter the text that currently appears and return to the previous setting screen.
	Touch this key and search results will appear based on the entered characters.



- "◀" in the text entry screen indicates how many characters can be entered. A number of characters greater than "◀" cannot be entered.
- The key layouts that can be selected vary depending on the language selected in "MFP Display Language Setting" in the system settings (administrator).
- The following symbols cannot be used when entering a file name or folder name.  
\ ? / " ; : , < > ! \* | & #  
Some computer environments may not allow the use of spaces and the symbols indicated below. For example, hyperlinks will not operate correctly or nonsense characters may appear.  
\$ % ' ( ) + - . = @ [ ] ^ ` { } \_ ~

# ENTERING TEXT FROM A KEYBOARD

A keyboard can only be used as a alternative for the text entry screen that appears in the machine's touch panel. The layout of the keys in the text entry screen in the touch panel differs slightly from the layout of the keys on the keyboard.

For details on using the keys, press the F1 key to view an explanation of each key.

## Entering text from a keyboard

### MX-B402SC Only

A keyboard can only be used as a alternative for the text entry screen that appears in the machine's touch panel. The layout of the keys in the text entry screen in the touch panel differs slightly from the layout of the keys on the keyboard. For details on using the keys, press the F1 key to view an explanation of each key.



Do not place heavy objects on the keyboard or press down on the keyboard.

# SOFTWARE SETUP

---

---

## BEFORE INSTALLING THE SOFTWARE

For an introduction to the software that enables the use of the printer and scanner functions, details regarding the type of CD-ROM that contains the software, and installation instructions, see "BEFORE INSTALLING THE SOFTWARE" in the Start Guide.

# SETUP IN A WINDOWS ENVIRONMENT

This section explains how to install the software and configure settings so that the printer and scanner function of the machine can be used with a Windows computer.

The section from this page to page 1-84 is also included in the Start Guide. (This section details basic setup procedures.)

The instructions from page 1-85 to page 1-106 are not included in the Start Guide. Refer to the guide as necessary.

## OPENING THE SOFTWARE SELECTION SCREEN (FOR ALL SOFTWARE)

### 1 Insert the "Software CD-ROM" into your computer's CD-ROM drive.

- If you are installing the printer driver or printer status monitor, insert the "Software CD-ROM" that shows "Disc 1" on the front of the CD-ROM.
- If you are installing the PC-Fax driver or scanner driver, insert the "Software CD-ROM" that shows "Disc 2" on the front of the CD-ROM.

### 2 Click the [Start] button ( ), click [Computer], and then double-click the [CD-ROM] icon ( ).

- In Windows XP/Server 2003, click the [start] button, click [My Computer], and then double-click the [CD-ROM] icon.
- In Windows 2000, double-click [My Computer] and then double-click the [CD-ROM] icon.

### 3 Double-click the [Setup] icon ( ).



- In Windows 7, if a message screen appears asking you for confirmation, click [Yes].
- In Windows Vista/Server 2008, if a message screen appears asking you for confirmation, click [Allow].

### 4 The "SOFTWARE LICENSE" window will appear. Make sure that you understand the contents of the license agreement and then click the [Yes] button.



You can show the "SOFTWARE LICENSE" in a different language by selecting the desired language from the language menu. To install the software in the selected language, continue the installation with that language selected.

### 5 Read the message in the "Welcome" window and then click the [Next] button.

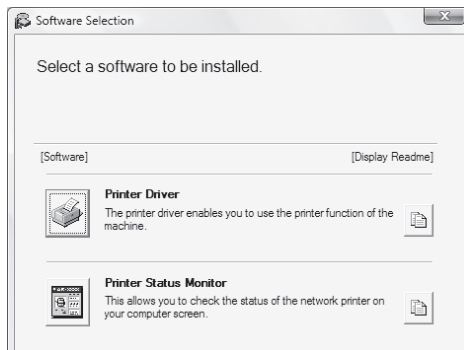

\* The above screen appears when using the "Disc 1" CD-ROM.

## The software selection screen appears.

The software selection screen appears.

Before installing the software, be sure to click the [Display Readme] button and view the detailed information on the software.

For the steps that follow, see the appropriate page below for the software that you are installing.

### INSTALLING THE PRINTER DRIVER / PC-FAX DRIVER

#### • WHEN THE MACHINE IS CONNECTED TO A NETWORK\*

- **Standard installation:** page 1-82
- **Installation by specifying the machine's address:** page 1-85
- **Printing using the IPP function and the SSL function:** page 1-88

#### • WHEN THE MACHINE WILL BE CONNECTED WITH A USB CABLE: page 1-90

#### • USING THE MACHINE AS A SHARED PRINTER: page 1-95

### INSTALLING THE PRINTER STATUS MONITOR: page 1-100

### INSTALLING THE SCANNER DRIVER: page 1-101

\* If the machine is being used on an IPv6 network, see "Installation by specifying the machine's address" (page 1-85).

## INSTALLING THE PRINTER DRIVER / PC-FAX DRIVER

To install the printer driver or the PC-Fax driver, follow the appropriate procedure in this section depending on whether the machine is connected to a network or connected by USB cable.

👉 [WHEN THE MACHINE WILL BE CONNECTED WITH A USB CABLE](#) (page 1-90)

### WHEN THE MACHINE IS CONNECTED TO A NETWORK

This section explains how to install the printer driver and the PC-Fax driver when the machine is connected to a Windows network (TCP/IP network).



- To print to the machine over the Internet using the IPP function when the machine is installed in a remote location, or to print using the SSL (encrypted communication) function, see "[Printing using the IPP function and the SSL function](#)" (page 1-88) and install the printer driver or the PC-Fax driver.
- **If the machine is connected to an IPv6-only network**  
The software cannot be installed by detecting the machine's address from the installer. After installing the software as explained in "[Installation by specifying the machine's address](#)" (page 1-85), change the port as explained in "[Changing to a Standard TCP/IP Port](#)" (page 1-105).
- The installation procedure in this section is for both the printer driver and the PC-Fax driver, although the explanations are centered on the printer driver.

## ► Standard installation

When the software selection screen appears in step 6 of "OPENING THE SOFTWARE SELECTION SCREEN (FOR ALL SOFTWARE)" (page 1-80), perform the steps below.

1

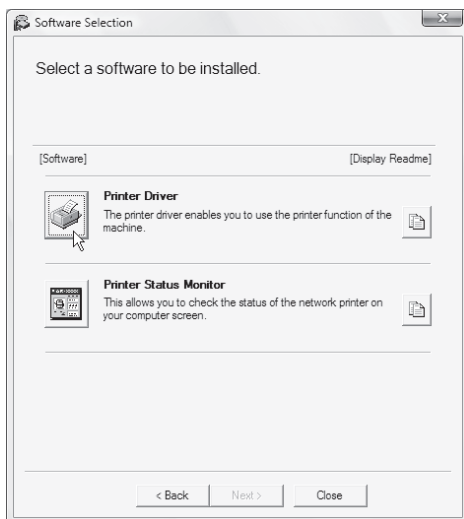

### Click the [Printer Driver] button.

To install the PC-Fax driver, click the [PC-Fax Driver] button on the "Disc 2" CD-ROM.

\* The above screen appears when using the "Disc 1" CD-ROM.

2

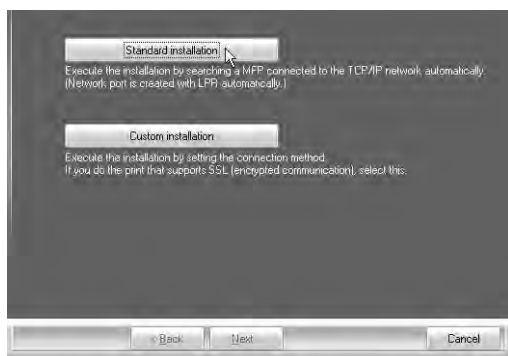

### Click the [Standard installation] button.



When [Custom installation] is selected, you can change any of the items below. When [Standard installation] is selected, the installation will take place as indicated below.

- Machine connection method: LPR Direct Print (Auto Search)
- Set as default printer: Yes (excluding the PC-Fax driver)
- Printer driver name: Cannot be changed
- Printer display fonts: Installed

If you selected [Custom installation], select [LPR Direct Print (Auto Search)] and click the [Next] button.

If you selected other than [LPR Direct Print (Auto Search)], see the following pages:

- LPR Direct Print (Specify Address): page 1-85
- IPP: page 1-88
- Shared printer: page 1-95
- Connected to this computer: page 1-90

3

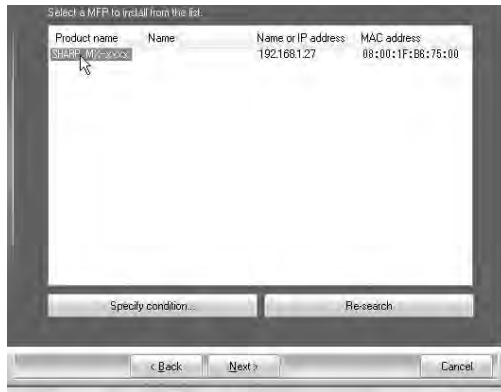

Printers connected to the network are detected. Select the machine and click the [Next] button.



- If the machine is not found, make sure that the machine is powered on and that the machine is connected to the network, and then click the [Re-search] button.
- You can also click the [Specify condition] button and search for the machine by entering the machine's name (host name) or IP address.
- Start Guide "Checking the IP address of the machine"

4

A confirmation window appears. Check the contents and then click the [Next] button.

5

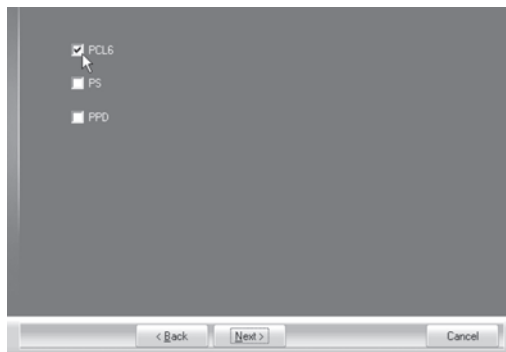

When the printer driver selection window appears, select the printer driver to be installed and click the [Next] button.

Click the checkbox of the printer driver to be installed so that a checkmark () appears.



When the PC-Fax driver is being installed, this screen does not appear. Go to the next step.

When you are asked whether or not you want the printer to be your default printer, make a selection and click the [Next] button.

If you are installing multiple drivers, select the printer driver to be used as the default printer.  
If you do not wish to set one of the printer drivers as the default printer, select [No].

6



If you clicked the [Custom installation] button in step 2, the following windows will appear.

- **Printer name window**  
If you wish to change the printer name, enter the desired name and click the [Next] button.
- **Window confirming installation of the display fonts**  
To install the display fonts, select [Yes] and click the [Next] button.
  - When the PC-Fax driver is being installed, this screen does not appear. Go to the next step.



## Follow the on-screen instructions.

Read the message in the window that appears and click the [Next] button. Installation begins.

**7**

- **If you are using Windows Vista/Server 2008/7**  
If a security warning window appears, be sure to click [Install this driver software anyway].
- **If you are using Windows 2000/XP/Server 2003**  
If a warning message regarding the Windows logo test or digital signature appears, be sure to click the [Continue Anyway] or [Yes] button.

**8**

When the installation completed screen appears, click the [OK] button.

**9**

After the installation, a message prompting you to restart your computer may appear. If this message appears, click the [Yes] button to restart your computer.

### This completes the installation.

- After installation, see "[CONFIGURING THE PRINTER DRIVER FOR THE OPTIONS INSTALLED ON THE MACHINE](#)" (page 1-97) to configure the printer driver settings.
- If you are using the machine as a shared printer, see "[USING THE MACHINE AS A SHARED PRINTER](#)" (page 1-95) to install the printer driver on each of the client computers.

## ► Installation by specifying the machine's address

When the machine cannot be found because it is not powered on or otherwise, installation is possible by entering the name (host name) or IP address of the machine.

If the machine is being used on an IPv6 network, after you have installed the software as explained below, change the port as explained in "Changing to a Standard TCP/IP Port" (page 1-105).

When the software selection screen appears in step 6 of "OPENING THE SOFTWARE SELECTION SCREEN (FOR ALL SOFTWARE)" (page 1-80), perform the steps below.

1



### Click the [Printer Driver] button.

To install the PC-Fax driver, click the [PC-Fax Driver] button on the "Disc 2" CD-ROM.

\* The above screen appears when using the "Disc 1" CD-ROM.

2

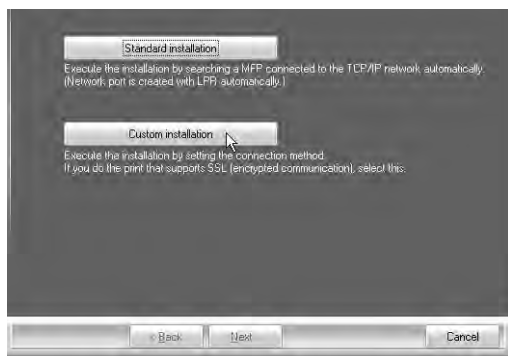

### Click the [Custom installation] button.

3



When you are asked how the printer is connected, select [LPR Direct Print (Specify Address)] and click the [Next] button.

4

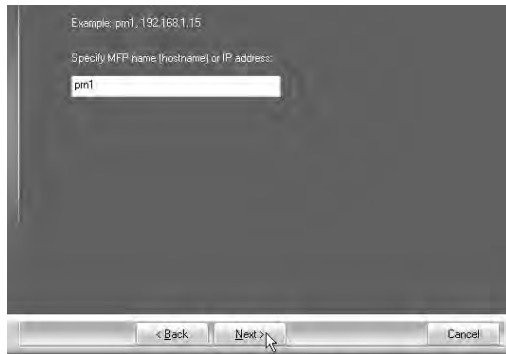

**Enter the name (host name) or IP address of the machine and click the [Next] button.**

 Start Guide "Checking the IP address of the machine"



If the machine is being used on an IPv6 network, enter any numbers or characters.

5

**When the model selection window appears, select the model name of your machine and click the [Next] button.**

6



**When the printer driver selection window appears, select the printer driver to be installed and click the [Next] button.**

Click the checkbox of the printer driver to be installed so that a checkmark () appears.



When the PC-Fax driver is being installed, this screen does not appear. Go to the next step.

7

**Select whether or not you wish the printer to be your default printer and click the [Next] button.**

If you are installing multiple drivers, select the printer driver to be used as the default printer.

If you do not wish to set one of the printer drivers as the default printer, select [No].

8

**When the printer name window appears, click the [Next] button.**

If you wish to change the printer name, enter the desired name and click the [Next] button.

9

**When you are asked if you wish to install the display fonts, select an answer and click the [Next] button.**

When the PC-Fax driver is being installed, this screen does not appear. Go to the next step.

## Follow the on-screen instructions.

Read the message in the window that appears and click the [Next] button. Installation begins.

10



- **If you are using Windows Vista/Server 2008/7**  
If a security warning window appears, be sure to click [Install this driver software anyway].
- **If you are using Windows 2000/XP/Server 2003**  
If a warning message regarding the Windows logo test or digital signature appears, be sure to click the [Continue Anyway] or [Yes] button.

11

When the installation completed screen appears, click the [OK] button.

12

Click the [Close] button in the window of step 1.



After the installation, a message prompting you to restart your computer may appear. If this message appears, click the [Yes] button to restart your computer.

**This completes the installation.**

- After installation, see "[CONFIGURING THE PRINTER DRIVER FOR THE OPTIONS INSTALLED ON THE MACHINE](#)" (page 1-97) to configure the printer driver settings.
- If the machine is being used on an IPv6 network, enter any numbers or characters.

## ► Printing using the IPP function and the SSL function

The IPP function can be used to print to the machine over a network using HTTP protocol.

The IPP function can also be used in combination with the SSL (encrypted communication) function to encrypt the print data. This enables secure printing with no concern that the data will be leaked to others.

 To use the SSL function, configure the "SSL Settings" in the system settings (administrator) of the machine. To configure the settings, see "7. SYSTEM SETTINGS".

When the software selection screen appears in step 6 of "[OPENING THE SOFTWARE SELECTION SCREEN \(FOR ALL SOFTWARE\)](#)" (page 1-80), perform the steps below.

1



### Click the [Printer Driver] button.

To install the PC-Fax driver, click the [PC-Fax Driver] button on the "Disc 2" CD-ROM.

\* The above screen appears when using the "Disc 1" CD-ROM.

2

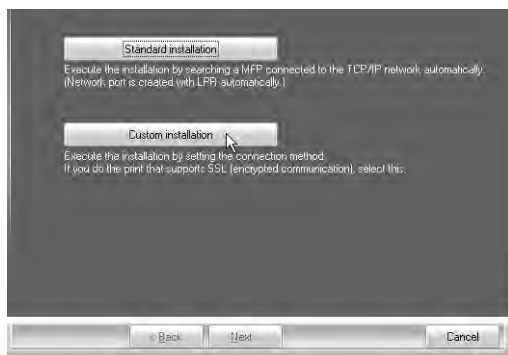

### Click the [Custom installation] button.

3



When you are asked how the printer is connected, select [IPP] and click the [Next] button.

4

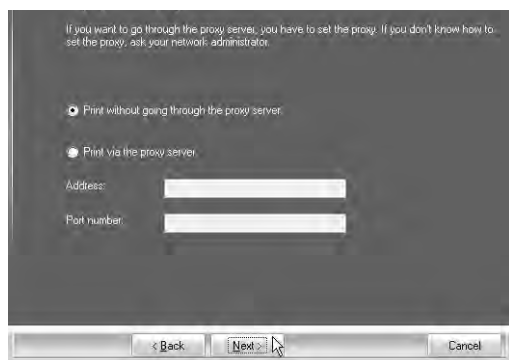

### If a proxy server is used, specify the proxy server and click the [Next] button.

To specify a proxy server, select [Print via the proxy server] and then enter the [Address] and [Port number].

5



### Enter the machine's URL and click the [Next] button.

Enter the URL in the following format:

#### Normal format:

http://<the machine's domain name or IP address>:631\*1/ipp

\*1 Normally "631" should be entered for the port number. If the IPP port number has been changed on the machine, enter the new port number.

#### When SSL is used:

https://< the machine's domain name or IP address>:<port number\*2>/ipp

\*2 Normally the port number and the colon ":" immediately preceding the port number can be omitted. If the IPP port number for SSL has been changed on the machine, enter the new port number.



If your computer and the machine are connected to the same local area network, you can click the [Search] button to search for the machine. The machine's URL will appear. Select the URL and click the [OK] button. You will return to the above screen and the machine's URL will be automatically entered.

6

## Perform steps 5 through 12 on page 1-86 to continue the installation.

**This completes the installation.**

After installation, see "[CONFIGURING THE PRINTER DRIVER FOR THE OPTIONS INSTALLED ON THE MACHINE](#)" (page 1-97) to configure the printer driver settings.

## WHEN THE MACHINE WILL BE CONNECTED WITH A USB CABLE



- **Make sure that a USB cable is not connected to your computer and the machine.**  
If a cable is connected, a Plug and Play window will appear. If this happens, click the [Cancel] button to close the window and disconnect the cable.
- To use the port created when the printer driver is installed for fax data transfer, install the printer driver first and then install the PC-Fax driver.

When the software selection screen appears in step 6 of "[OPENING THE SOFTWARE SELECTION SCREEN \(FOR ALL SOFTWARE\)](#)" (page 1-80), perform the steps below.

1

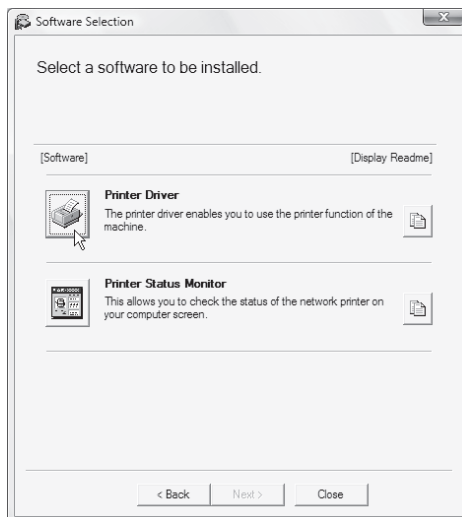

Click the [Printer Driver] button.

2

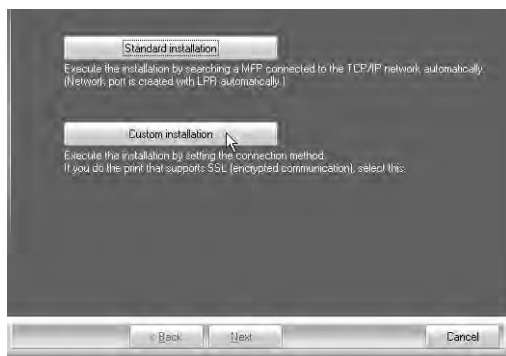

Click the [Custom installation] button.

3



When you are asked how the printer is connected, select [Connected to this computer] and click the [Next] button.

- 4** When you are asked if you wish to install the display fonts, select an answer and click the [Next] button.

### Follow the on-screen instructions.

Read the message in the window that appears and click the [Next] button.

When the installation completed screen appears, click the [OK] button.

- 5**
- **If you are using Windows Vista/Server 2008/7**  
If a security warning window appears, be sure to click [Install this driver software anyway].
  - **If you are using Windows 2000/XP/Server 2003**  
If a warning message regarding the Windows logo test or digital signature appears, be sure to click the [Continue Anyway] or [Yes] button.

### Click the [Close] button in the window of step 1.

When a message appears prompting you to connect the machine to your computer, click the [OK] button.

- 6**
- After the installation, a message prompting you to restart your computer may appear. If this message appears, click the [Yes] button to restart your computer.

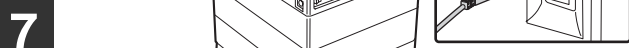

### Connect the machine to your computer with a USB cable.

- (1) Make sure that the machine is powered on.
- (2) Connect the cable to the USB connector (B type) on the machine.

The USB interface on the machine complies with the USB 2.0 (Hi-Speed) standard. Please purchase a shielded USB cable.

- (3) Connect the other end of the cable to the USB connector (A type) on your computer.

The machine is found and a Plug and Play window appears.

### Installation of the PCL6 printer driver begins.

When the "Found New Hardware Wizard" appears, select [Install the software automatically (Recommended)], click the [Next] button, and follow the on-screen instructions.

- 8**
- **If you are using Windows Vista/Server 2008/7**  
If a security warning window appears, be sure to click [Install this driver software anyway].
  - **If you are using Windows 2000/XP/Server 2003**  
If a warning message regarding the Windows logo test or digital signature appears, be sure to click the [Continue Anyway] or [Yes] button.

### This completes the installation.

- After installing the printer driver, see "[CONFIGURING THE PRINTER DRIVER FOR THE OPTIONS INSTALLED ON THE MACHINE](#)" (page 1-97) to configure the printer driver settings.
- If you are using the machine as a shared printer, see "[USING THE MACHINE AS A SHARED PRINTER](#)" (page 1-95) to install the printer driver on each of the client computers.



**When installing the PCL5e printer driver, PS printer driver, PPD driver, or PC-Fax driver**

Installation is possible even after the USB cable has been connected. When the software selection screen appears in step 6 of "**OPENING THE SOFTWARE SELECTION SCREEN (FOR ALL SOFTWARE)**" (page 1-80), perform the steps below.

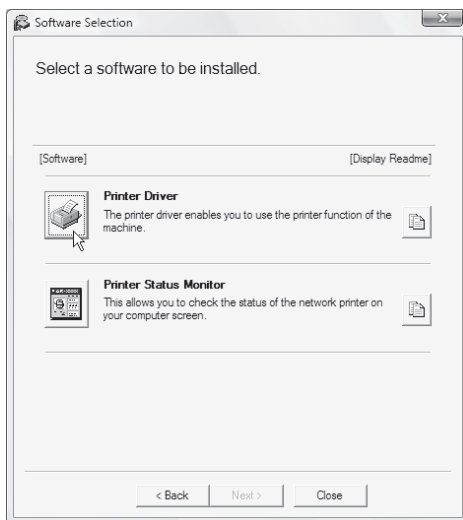
**1****Click the [Printer Driver] button.**

To install the PC-Fax driver, click the [PC-Fax Driver] button on the "Disc 2" CD-ROM.

\* The above screen appears when using the "Disc 1" CD-ROM.

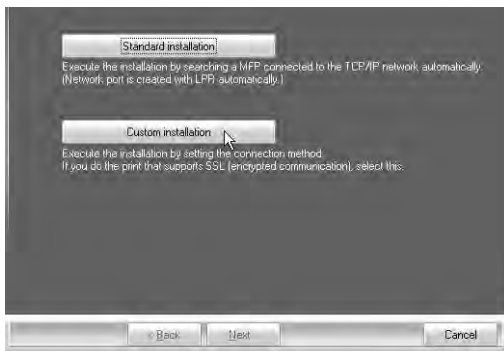
**2****Click the [Custom installation] button.****3**

**When you are asked how the printer is connected, select [Connected to this computer] and click the [Next] button.**

**4**

**When the port selection window appears, select the port that the PCL6 printer driver is using (USB001, etc.) and click the [Next] button.**

5



**When the printer driver selection window appears, remove the [PCL6] checkmark and select the printer driver to be installed, and then click the [Next] button.**

Click the checkbox of the printer driver to be installed so that a checkmark () appears.



When the PC-Fax driver is being installed, this screen does not appear. Go to the next step.

6

**Select whether or not you wish the printer to be your default printer and click the [Next] button.**

If you are installing multiple drivers, select the printer driver to be used as the default printer.

If you do not wish to set one of the printer drivers as the default printer, select [No].

7

**When the printer name window appears, click the [Next] button.**

If you wish to change the printer name, enter the desired name and click the [Next] button.

8

**When you are asked if you wish to install the display fonts, select [No] and click the [Next] button.**

When the PC-Fax driver is being installed, this screen does not appear. Go to the next step.

**Follow the on-screen instructions.**

Read the message in the window that appears and click the [Next] button.

Installation begins.

9



**• If you are using Windows Vista/Server 2008/7**

If a security warning window appears, be sure to click [Install this driver software anyway].

**• If you are using Windows 2000/XP/Server 2003**

If a warning message regarding the Windows logo test or digital signature appears, be sure to click the [Continue Anyway] or [Yes] button.

10

**When the installation completed screen appears, click the [OK] button.**

11

**Click the [Close] button in the window of step 1.**



After the installation, a message prompting you to restart your computer may appear. If this message appears, click the [Yes] button to restart your computer.

**This completes the installation.**

- After installation, see "[CONFIGURING THE PRINTER DRIVER FOR THE OPTIONS INSTALLED ON THE MACHINE](#)" (page 1-97) to configure the printer driver settings.
- Make sure that the port of the installed driver is the same as the port used by the PCL6 printer driver. The port used by the printer driver of the machine is indicated by a checkmark on the [Ports] tab of the printer driver properties window.
  - [CHANGING THE PORT](#) (page 1-103)

## USING THE MACHINE AS A SHARED PRINTER

If you are going to use the machine as a shared printer on a Windows network with the printer driver or the PC-Fax driver installed on a print server, follow the steps below to install the printer driver or the PC-Fax driver on the client computers.



- Ask your network administrator for the server name and printer name of the machine on the network.
- For the procedure for configuring settings on the print server, see the operation manual or the Help file of the operating system. The "print server" explained here is a computer that is connected directly to the machine, and "clients" are other computers connected to the same network as the print server.
- Install the same printer driver on client computers as the printer driver that is installed on the print server.

When the software selection screen appears in step 6 of "[OPENING THE SOFTWARE SELECTION SCREEN \(FOR ALL SOFTWARE\)](#)" (page 1-80), perform the steps below.

### 1

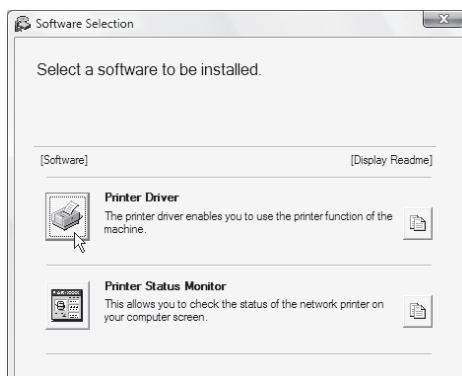

### Click the [Printer Driver] button.

To install the PC-Fax driver, click the [PC-Fax Driver] button on the "Disc 2" CD-ROM.

\* The above screen appears when using the "Disc 1" CD-ROM.

### 2

### Click the [Custom installation] button.

### 3

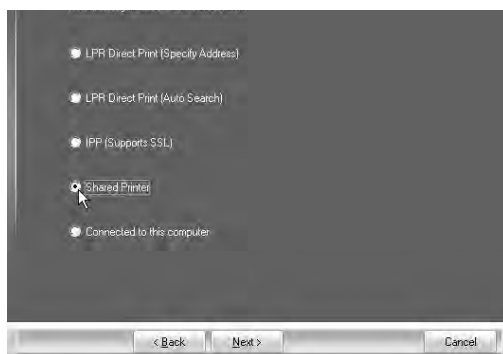

### Select [Shared Printer] and click the [Next] button.

4

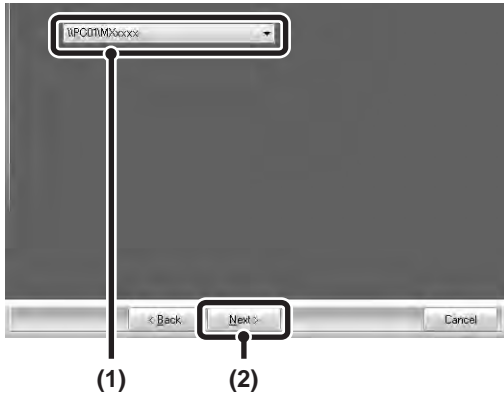

**Select the printer name (configured as a shared printer).**

**(1) Select the printer name (configured as a shared printer on a print server) from the list.**

If you are using Windows 2000/XP/Server 2003, you can also click the [Add Network Port] button displayed below the list and select the printer to be shared by browsing the network in the window that appears.

**(2) Click the [Next] button.**



If the shared printer does not appear in the list, check the settings on the print server.

5

**Perform steps 5 through 12 on page 1-86 to continue the installation.**

In the printer driver selection screen, be sure to select the same type of printer as the printer driver installed on the print server.

**This completes the installation.**

## CONFIGURING THE PRINTER DRIVER FOR THE OPTIONS INSTALLED ON THE MACHINE

After installing the printer driver, you must configure the printer driver settings appropriately for the options that have been installed and the size and type of paper loaded in the machine. Follow the steps below to configure the printer driver.

 If the PPD driver is installed, see "[When the PPD driver is installed](#)" (page 1-99).

### ► When the PCL printer driver or PS printer driver is installed

#### 1 Click the [Start] button ( ), click [Control Panel], and then click [Printer].

- In Windows XP/Server 2003, click the [start] button and then click [Printers and Faxes].
- In Windows 2000, click the [Start] button, select [Settings], and then click [Printers].

 If [Printers and Faxes] does not appear in the [start] menu in Windows XP, click the [start] button, click [Control Panel], click [Printers and Other Hardware], and then click [Printers and Faxes].

#### 2 Open the printer properties window.

- (1) Right-click the printer driver icon of the machine.
- (2) Select [Properties].

#### 3 Click the [Configuration] tab.

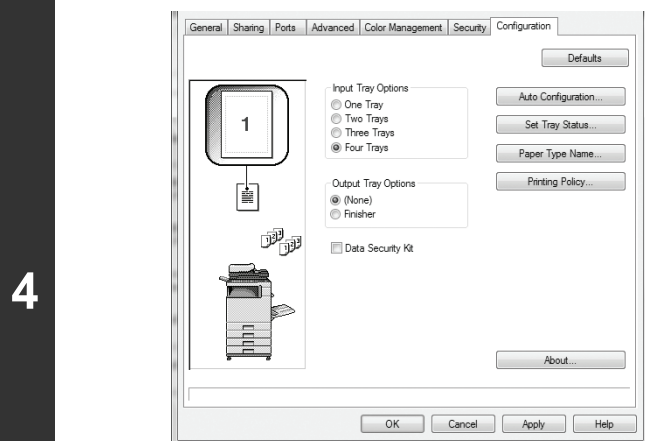

#### Click the [Auto Configuration] button.

The settings are automatically configured based on the detected machine status.

 If the machine is being used on an IPv6 network, you must configure the options manually as explained in "[If automatic configuration fails](#)" (page 1-98).

5

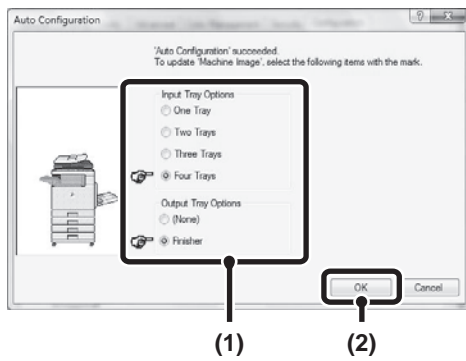

### Configure the image of the machine.

An image of the machine is formed in the printer driver configuration window based on the options that are installed.

- (1) Select the options that are installed on the machine.
- (2) Click the [OK] button.

 To cancel the image settings, click the [Cancel] button.

6

### Click the [OK] button in the printer properties window.

-  **If automatic configuration fails**
- You can check the options that are installed and the tray settings by printing out the "All Custom Setting List" in the system settings of the machine. (However, note that "Input Tray Options" must be set to the number of trays on the machine.) Follow these steps to print out the "All Custom Setting List": Press the [SYSTEM SETTINGS] key, touch the [List Print (User)] key, and then touch the [Print] key of "All Custom Setting List".
  - Click the [Set Tray Status] button, the [Paper Type Name] button, and the [Set Tandem Print]\* button to check the settings of each.
 

Set Tray Status: The "Tray Settings" in "Paper Tray Settings" in system settings of the machine are reflected in the settings shown here. Specify the size and type of paper loaded in each tray.

Paper Type Name: The "Paper Type Registration" settings in "Paper Tray Settings" in the system settings of the machine are reflected in the settings shown here. If a user type name (1 to 7) was changed, enter the changed name.

**► When the PPD driver is installed****1 Click the [Start] button (  ), click [Control Panel], and then click [Printer].**

- In Windows XP/Server 2003, click the [start] button and then click [Printers and Faxes].
- In Windows 2000, click the [Start] button, select [Settings], and then click [Printers].



If [Printers and Faxes] does not appear in the [start] menu in Windows XP, click the [start] button, click [Control Panel], click [Printers and Other Hardware], and then click [Printers and Faxes].

**2 Open the printer properties window.**

- (1) Right-click the printer driver icon of the machine.
- (2) Select [Properties].

**3 Configure the printer driver for the options installed on the machine.**

- (1) Click the [Device Settings] tab.
- (2) Configure each item based on the machine configuration.

The items and the procedures for configuring the items vary depending on the operating system version.

- (3) Click the [OK] button.



You can check the options that are installed on the machine by printing out the "All Custom Setting List" in the system settings. (However, note that "Input Tray Options" must be set to the number of trays on the machine.) Follow these steps to print out the "All Custom Setting List": Press the [SYSTEM SETTINGS] key, touch the [List Print (User)] key, and then touch the [Print] key of "All Custom Setting List".



# INSTALLING THE PRINTER STATUS MONITOR

Printer Status Monitor is a printer utility that allows general users to check the current status of the machine on their computer screen, such as whether or not the machine is ready to print. The Printer Status Monitor shows error information such as paper misfeeds, printer configuration information (whether or not a finisher is installed, etc.) as an image, the paper sizes that can be used, and the amount of paper remaining.



The Printer Status Monitor cannot be used in the following situations:

- When the machine is connected by a USB cable.
- When printing to the machine using the IPP function.

When the software selection screen appears in step 6 of "[OPENING THE SOFTWARE SELECTION SCREEN \(FOR ALL SOFTWARE\)](#)" (page 1-80), perform the steps below.

1

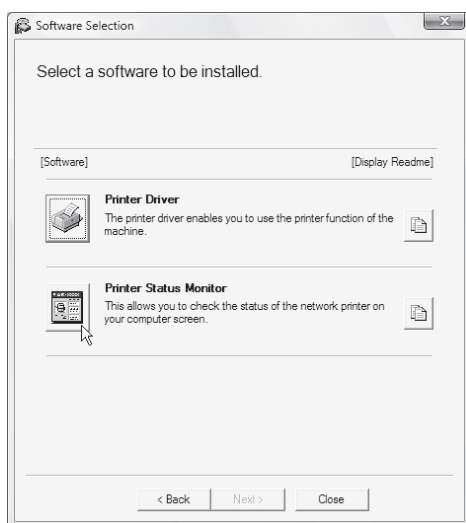

Click the [Printer Status Monitor] button.

2

Follow the on-screen instructions.

3

When the installation completed screen appears, click the [Finish] button.

To have the Printer Status Monitor start automatically when your computer is started, select the [Add this program to your Startup folder] checkbox  and click the [Finish] button.

4

Click the [Close] button in the window of step 1.



After the installation, a message prompting you to restart your computer may appear. If this message appears, click the [Yes] button to restart your computer.

**This completes the installation.**

For the procedures for using the Printer Status Monitor, see the Help file. Follow these steps to view the Help file: Click the Windows [start] button, select [All Programs] ([Programs] in Windows 2000), select [SHARP Printer Status Monitor] and then select [Help].

# INSTALLING THE SCANNER DRIVER

The scanner driver (TWAIN driver) can only be used when the machine is connected to a network. When the scanner driver is installed, PC scan mode of the image send function can be used.

After performing step 1 through step 5 of "[OPENING THE SOFTWARE SELECTION SCREEN \(FOR ALL SOFTWARE\)](#)" (page 1-80), continue the steps below.

1

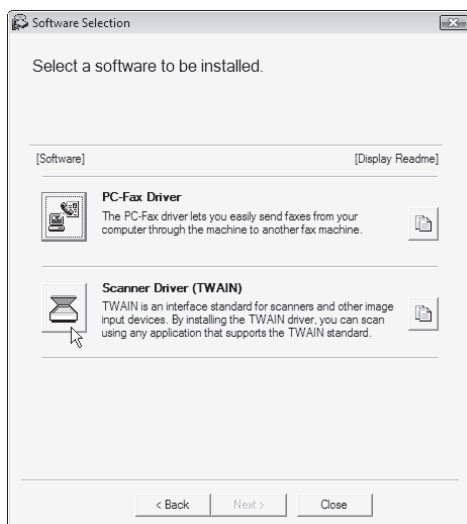

Click the **[Scanner Driver (TWAIN)]** button.

2

## Follow the on-screen instructions.

Read the message in the window that appears and click the [Next] button.

3

## When the finish setup window appears, click the [OK] button.

4

## Click the [Close] button in the window of step 1.

 After the installation, a message prompting you to restart your computer may appear. If this message appears, click the [Yes] button to restart your computer.

**This completes the installation. Next, configure the IP address of the machine in the scanner driver.**

When the scanner driver is installed, the "Select Device" utility is also installed.

The IP address of the machine is configured in the scanner driver using "Select Device".

5

## Click the [start] button, select [All Programs] ([Programs] in Windows 2000), select [SHARP MFP TWAIN V], and then select [Select Device].

6

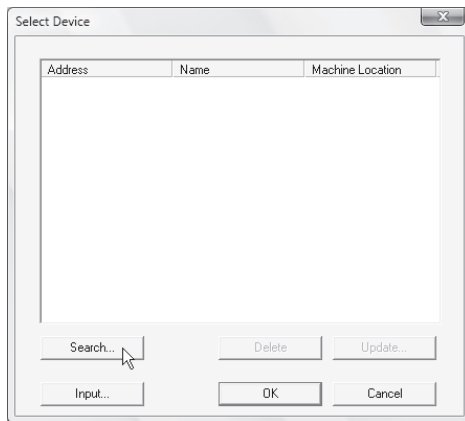

### Click the [Search] button.

If you know the IP address, you can click the [Input] key and enter the IP address without searching.

7

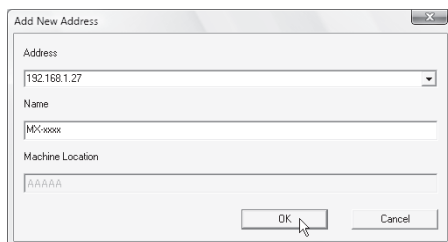

### Select the IP address of the machine from the "Address" menu and click the [OK] button.

- Be sure to ask your system administrator (network administrator) for the IP address of the machine.
- The name (host name) or IP address of the machine can be directly entered in "Address".
- If the port number used by the scanner function of the machine has been changed, enter a colon ":" following the IP address and then enter the port number. (Normally the port number does not need to be entered.)

8

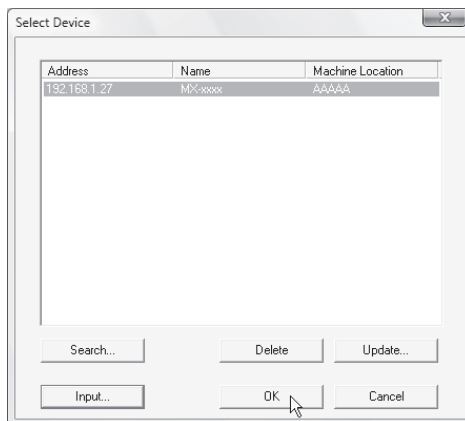

### Click the [OK] button.

This completes the configuration of the scanner driver.

## CHANGING THE PORT

When using the machine in a Windows environment, follow the steps below to change the port when you have changed the IP address of the machine or have installed the PC-Fax driver when the machine is connected with a USB cable. If the machine is being used on an IPv6 network, follow the steps 1 to 3 below and see "[Changing to a Standard TCP/IP Port](#)" (page 1-105) for the remaining steps of the procedure to change the port.

1

**Click the [Start] button ( ), click [Control Panel], and then click [Printer].**

- In Windows XP/Server 2003, click the [start] button and then click [Printers and Faxes].
- In Windows 2000, click the [Start] button, select [Settings], and then click [Printers].



If [Printers and Faxes] does not appear in the [start] menu in Windows XP, click the [start] button, click [Control Panel], click [Printers and Other Hardware], and then click [Printers and Faxes].

2

**Open the printer properties window.**

- (1) **Right-click the printer driver icon of the machine.**
- (2) **Select [Properties].**

3

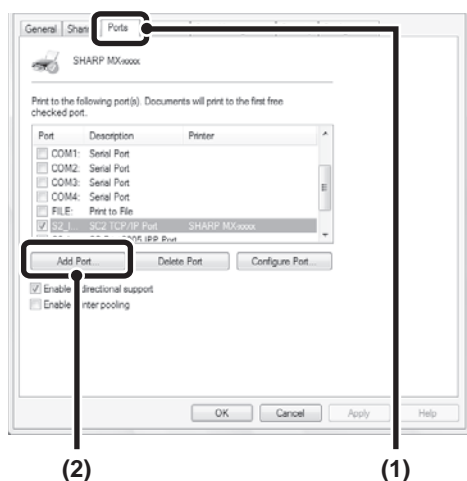

**Adding or changing a port.**

- (1) **Click the [Ports] tab.**
- (2) **Click the [Add Port] button.**



To change to a previously created port such as USB port, select the desired port (USB001, etc.) from the list and click the [Apply] button. This changes the port.

4

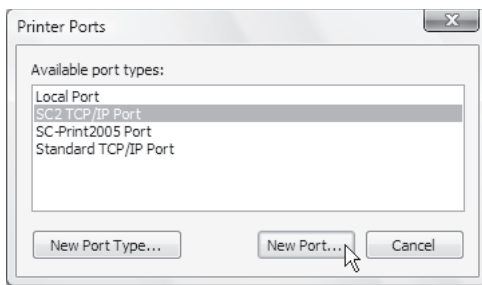

Select [SC2 TCP/IP Port] and then click the [New Port] button.



- The "SC2 TCP/IP Port" is added when the printer driver is installed using a "Standard installation", or a "Custom installation" with "LPR Direct Print (Specify Address/Auto Search)" selected.
- If the printer driver is installed using a "Custom installation" with "IPP" selected, the [SC-Print2005 Port] is added. If you need to change the printer port when the machine is connected to an intranet or a wide area network (WAN) using the IPP function, select [SC-Print2005 Port], click the [New Port] button, and follow the on-screen instructions to create the port again.

5

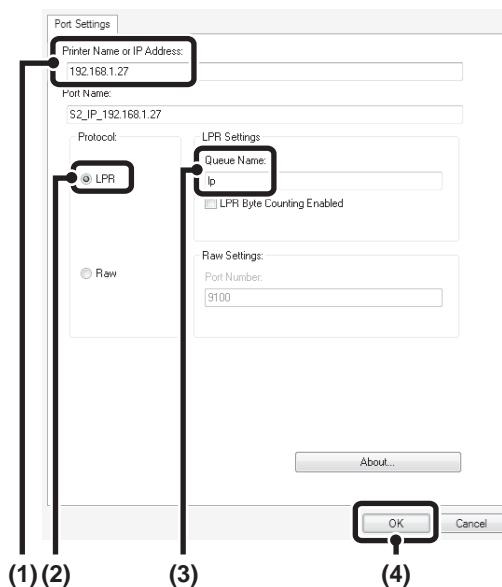

Create the new port.

(1) Enter the machine's IP address.

Start Guide "Checking the IP address of the machine"

(2) Make sure that [LPR] is selected.

(3) Make sure that [lp] is entered.

(4) Click the [OK] button.

6

Click the [Close] button in the screen of step 4.

7

Make sure the created printer port is selected in the printer properties window and then click the [Apply] button.

## ► Changing to a Standard TCP/IP Port

If the machine is being used on an IPv6 network, change the port to a port created using the operating system's "Standard TCP/IP Port".

**1** Follow steps 1 to 3 of "**CHANGING THE PORT**" (page 1-103).

**2**

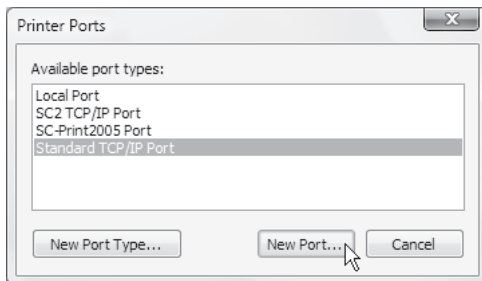

Select [Standard TCP/IP Port] and then click the [New Port] button.

**3**

Click the [Next] button.

**4**

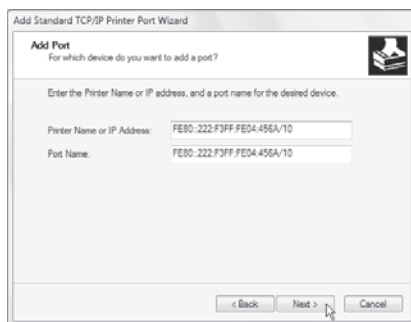

Enter the machine's IPv6 address in [Printer Name or IP Address] and click the [Next] button.

**5**

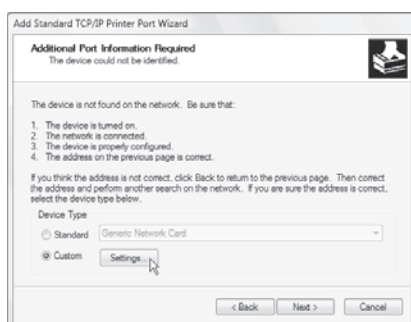

Select [Custom] and click the [Settings] button.

6

### Configure the port settings.

- (1) Select [LPR].
- (2) Enter [lp].
- (3) Click the [OK] button.

7

Click the [Next] button in the screen of step 5.

8

Click the [Finish] button.

9

Click the [Close] button in the screen of step 2.

#### When using a port created with "Standard TCP/IP Port"

In the screen that appears after you click the [Configure Port] button in the screen of step 3, make sure the [SNMP Status Enabled] checkbox is not selected (). If the [SNMP Status Enabled] checkbox is selected () , it may not be possible to print correctly.

# SETUP IN A MACINTOSH ENVIRONMENT

This chapter explains how to install the PPD file to enable printing from a Macintosh and how to configure the printer driver settings.

 **MAC OS X:** this page

(v10.2.8, v10.3.9, v10.4.11, v10.5 - 10.5.8., v10.6 - 10.6.2)

 **MAC OS 9.0 - 9.2.2:** page 1-113



- To use the machine as a printer in a Macintosh environment, the machine must be connected to a network. A USB connection cannot be used.
- The scanner driver and PC-Fax driver cannot be used in a Macintosh environment.

## MAC OS X



- The explanations of screens and procedures are primarily for Mac OS X v10.4. The screens may vary in other versions of the operating system.
- The CD-ROM does not include software for Mac OS X10.2.8 and X10.3.9. Contact your dealer or nearest authorized service representative if you want software for X10.2.8 and X10.3.9.

**1**

### Insert the "Software CD-ROM" into your computer's CD-ROM drive.

Insert the "Software CD-ROM" that shows "Disc 1" on the front of the CD-ROM.

**2**

### Double-click the [CD-ROM] icon ( ) on the desktop.

**3**

### Double-click the [MacOSX] folder.

Before installing the software, be sure to read "ReadMe First". "ReadMe First" is in the [US-English] folder ([English] folder in areas other than the U.S.) in the [Readme] folder.

**4**

### Double-click the folder corresponding to the versions of the operating system.

**5**

### Double-click the [MX-PKX] icon ( ).

 If the "Authenticate" window appears in Mac OS X v10.2.8, enter the password and click the [OK] button.



6



Click the [Continue] button.

7

The License Agreement window will appear. Make sure that you understand the contents of the license agreement and then click the [Continue] button.

A message will appear asking you if you agree to the terms of the license. Click the [Agree] button.



If the license appears in the different language, change the language in the language menu.

8



Select the hard drive where the PPD file will be installed and click the [Continue] button.

- Be sure to select the hard drive on which your operating system is installed.
- In Mac OS X v10.6 - 10.6.2, the screen below appears when you click the [Change Install Location] button.

9



Click the [Install] button.

Installation begins.



If the "Authenticate" window appears, enter the password and click the [OK] button.

10

When the message "The software was successfully installed" appears in the installation window, click the [Close] button.

This completes the installation of the software. Next, configure the printer driver settings.

11

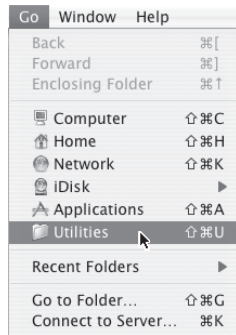

### Select [Utilities] from the [Go] menu.

- If you are using Mac OS X v10.5 to 10.5.8 or v10.6 - 10.6.2, click [System Preferences] in the Apple menu () and select [Print & Fax] (⌘). When the screen for adding a printer appears, click the  button and go to step 14.
- If you are using Mac OS X v10.2.8, select [Applications] from the [Go] menu.

12

### Double-click the [Printer Setup Utility] icon (⌘).

If you are using Mac OS X v10.2.8, double-click the [Utilities] folder and then double-click the [Print Center] icon.



If this is the first time you are installing a printer driver on your computer, a confirmation message will appear. Click the [Add] button.

13

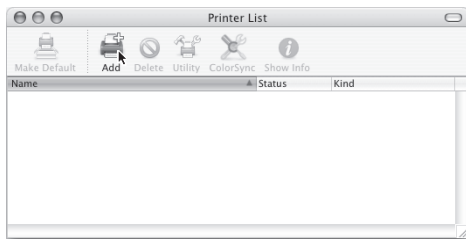

### Click [Add].

14

### Configure the printer driver.

- The procedure for configuring the printer driver varies depending on the operating system version. The procedure for versions 10.4.11, 10.5 - 10.5.8 and 10.6 to 10.6.2, and the procedure for other versions are explained separately below.
- The machine can print using the IPP function. If you wish to use the IPP function, see "[Printing using the IPP function](#)" (page 1-112) to configure the printer driver settings.

## v10.4.11, v10.5 - 10.5.8, v10.6 - 10.6.2

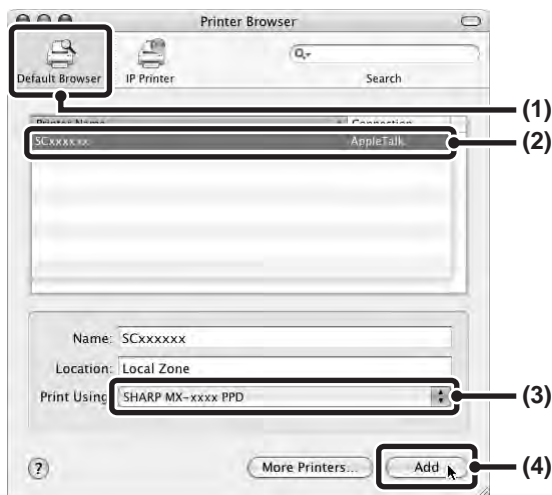
**(1) Click the [Default Browser] icon.**

If you are using Mac OS X v10.5 to 10.5.8 or v10.6 - 10.6.2, click the [Default] icon.

**(2) Click the machine's model name.**

- Using with AppleTalk:  
The machine's model name usually appears as [SCxxxxxx]\*.
  - Using with Bonjour:  
The machine's model name usually appears as [RDVxxxxxx]\*.
- \* "xxxxxx" is a sequence of characters that varies depending on your model.

**(3) Make sure that the PPD file of your model is selected.**

The PPD file of the machine is automatically selected.

**(4) Click the [Add] button.**

- Using with AppleTalk:  
The PPD file of the machine is automatically selected and the peripheral devices installed on the machine are detected and automatically configured.
- Using with Bonjour:  
The "Installable Options" screen appears. Select the machine configuration and click the [Continue] button.

## v10.2.8, v10.3.9

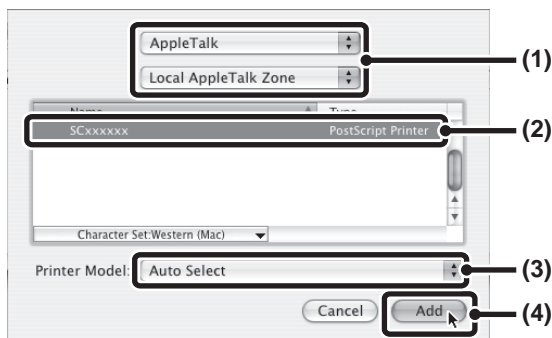
**(1) Select [AppleTalk].**

If multiple AppleTalk zones are displayed, select the zone that includes the printer from the menu.

**(2) Click the machine's model name.**

The machine's model name usually appears as [SCxxxxxx]. ("xxxxxx" is a sequence of characters that varies depending on your model.)

**(3) Select the PPD file of the machine.**

- If you are using Mac OS X v10.3.9, select [Auto Select].
- If you are using Mac OS X v10.2.8, select [Sharp] and click the PPD file of your model.

**(4) Click the [Add] button.**

If you are using Mac OS X v10.3.9, the PPD file of the machine is automatically selected and the peripheral devices installed on the machine are detected and automatically configured.



The PPD file is installed in the following folders on the startup disk.  
[Library] - [Printers] - [PPDs] - [Contents] - [Resources] - [en.lproj]

15



## Display printer information.

### (1) Click the machine's name.

If you are using Mac OS X v10.5 to 10.5.8 or v10.6 - 10.6.2, click the [Options & Supplies] button, click the [Driver] tab and go to step 16.

### (2) Click [Show Info].

If you are using Mac OS X v10.2.8, select [Show Info] from the [Printers] menu.

16

## Select the machine configuration.

If you selected [Auto Select] in (3) of step 14, the machine configuration is detected and automatically configured. Check the configured settings to make sure they are correct.

### (1) Select [Installable Options].

If you are using Mac OS X v10.5 to 10.5.8 or v10.6 - 10.6.2, it does not appear.

### (2) Select the options that are installed on the machine.

### (3) Click the [Apply Changes] button.

If you are using Mac OS X v10.5 to 10.5.8 or v10.6 - 10.6.2, click the [OK] button.

### (4) Click to close the window.



You can check the options that are installed on the machine by printing out the "All Custom Setting List" in the system settings. (However, note that "Input Tray Options" must be set to the number of trays on the machine.) The "All Custom Settings List" can be printed from [List Print (User)] in the system settings.

**This completes the configuration of the printer driver.**

## ► Printing using the IPP function

The machine can print using the IPP function. When the machine is in a remote location, this function can be used in place of the fax function to print a higher than a fax. If you wish to use the IPP function, follow these steps to select the PPD file when configuring the printer driver (step 14 on page 1-109).

v10.4.11, v10.5 - 10.5.8, v10.6 - 10.6.2

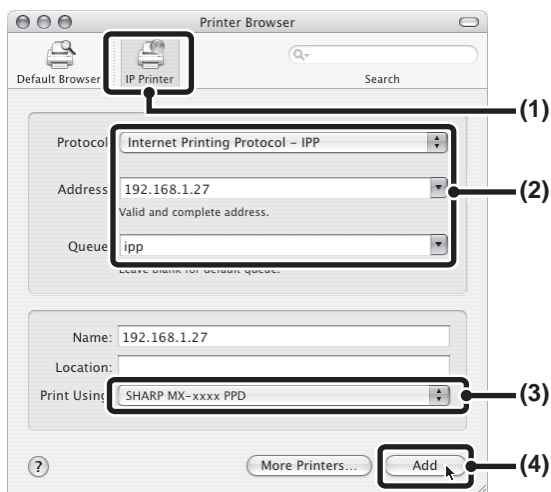

### (1) Click the [IP Printer] icon.

If you are using Mac OS X v10.5 to 10.5.8 or v10.6 - 10.6.2, click the [IP] icon.

### (2) Select [Internet Printing Protocol] in "Protocol". Enter the address of the machine (IP address or domain name) and the queue name.

Enter "ipp" in "Queue".

### (3) Select [Sharp] in "Print Using" and click the PPD file of your model.

If you are using Mac OS X v 10.5 to 10.5.8 or v10.6 - 10.6.2, select [Select a driver to use] (or [Select Printer Software]) from "Print Using" and click the PPD file for your model.

### (4) Click the [Add] button.

The "Installable Options" screen will appear. Make sure that the settings are correct and click the [Continue] button.

☞ Start Guide "Checking the IP address of the machine"

v10.2.8, v10.3.9

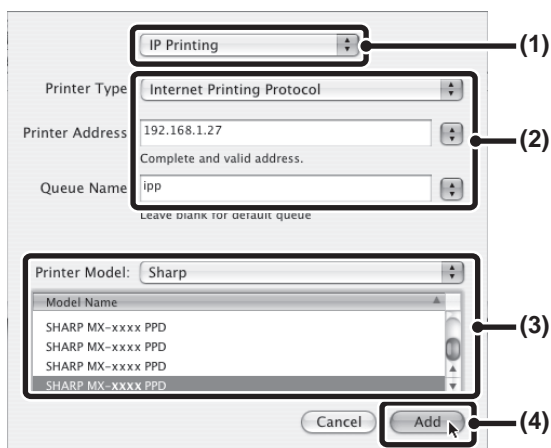

### (1) Select [IP Printing].

### (2) Select [Internet Printing Protocol] in "Printer Type". Enter the address of the machine (IP address or domain name) and the "Queue Name".

- If you are using Mac OS X v10.2.8, enter the address of the machine (IP address or domain name) in "Printer's Address".

- Enter "ipp" in "Queue Name".

### (3) Select [Sharp] in "Printer Model" and click the PPD file of your model.

### (4) Click the [Add] button.

☞ Start Guide "Checking the IP address of the machine"

## MAC OS 9.0 - 9.2.2

- If you are using Mac OS 9.0 to 9.2.2, make sure that "LaserWriter 8" has been installed and that the "LaserWriter 8" checkbox is selected  in "Extensions Manager" in "Control Panels". If not, install it from the system CD-ROM supplied with your Macintosh computer.
- The CD-ROM does not include software for Mac OS 9.0 to 9.2.2.  
Contact your dealer or nearest authorized service representative if you want software for Mac OS 9.0 to 9.2.2.

**1** Download the software and save the extracted files in any folder.

**2** Double-click the [MacOS] folder.

Before installing the software, be sure to read "ReadMe First". "ReadMe First" is in the [US-English] folder ([English] folder in areas other than the U.S.) in the [Readme] folder.

**3** Double-click the [Installer] icon (📄).

**4**  Click the [Install] button.

**5** The License Agreement window will appear. Make sure that you understand the contents of the license agreement and then click the [Yes] button.

**6** Read the message in the window that appears and click the [Continue] button.

Installation of the PPD file begins.  
After the installation, a message prompting you to restart your computer will appear. Click the [OK] button and restart your computer.

This completes the installation of the software. Next, configure the printer driver settings.

**7** Select [Chooser] from the Apple Menu.

8

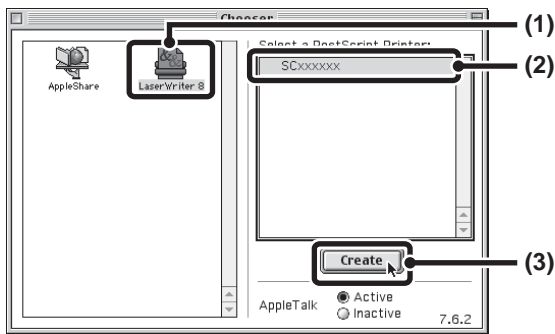

## Create a printer.

### (1) Click the [LaserWriter 8] icon.

If multiple AppleTalk zones are displayed, select the zone that includes the printer.

### (2) Click the machine's model name.

The machine's model name usually appears as [SCxxxxxx]. ("xxxxxx" is a sequence of characters that varies depending on your model.)

### (3) Click the [Create] button.

9

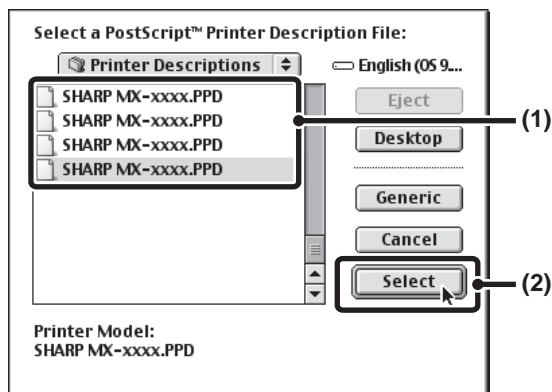

## Select the PPD file.

### (1) Click the PPD file for your model.

### (2) Click the [Select] button.



- If the above dialog box does not appear and you return to the "Chooser" dialog box, follow these steps to select the PPD file manually.
  - (1) Make sure that the machine is selected in the "Select a PostScript Printer" list, and then click the [Setup] button followed by the [Select PPD] button.
  - (2) Select the PPD file for your model and click the [Open] button.
  - (3) Click the [OK] button.
- The PPD file is installed in the [Printer Descriptions] folder in the [Extensions] folder.

10

## Make sure that the machine is selected in the "Select a PostScript Printer" list and then click the [Setup] button.

11

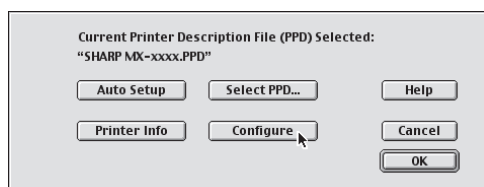

## Click the [Configure] button.



- To automatically configure the settings based on the installed machine options that are detected, click the [Auto Setup] button.

**Select the machine configuration.**

- (1) Select the options that are installed on the machine.
- (2) Select [Options 2] from the menu to change the screen and continue selecting the options that have been installed on the machine.
- (3) Click the [OK] button.

12



You can check the options that are installed on the machine by printing out the "All Custom Setting List" in the system settings. (However, note that "Input Tray Options" must be set to the number of trays on the machine.) Follow these steps to print out the "All Custom Setting List": Press the [SYSTEM SETTINGS] key, touch the [List Print (User)] key, and then touch the [Print] key of "All Custom Setting List".

13

**Click the [OK] button in the window of step 12 to close the window.**

14

**Click the close box (  ) to close the "Chooser".**

This completes the configuration of the printer driver.

**Installing the screen fonts**

The screen fonts for Mac OS 9.0 - 9.2.2 are contained in the [Font] folder of the "Software CD-ROM"(Disc 1). Copy the fonts that you wish to install to the [System Folder] of the startup disk.



If you experience problems that may be due to the installed screen fonts, immediately delete the installed fonts from the system.



# REMOVING THE SOFTWARE

To remove the printer driver or software installed using the installer, follow the steps below.

## Windows

### 1 Click the [start] button and then click [Control Panel].

In Windows 2000, click the [Start] button, point to [Settings], and click [Control Panel].

### 2 Click [Uninstall a program].

- In Windows XP/Server 2003, click [Add or Remove Programs].
- In Windows 2000, double-click the [Add/Remove Programs] icon.

### 3 Select the program or driver that you wish to delete.

For more information, see the manual for the operating system or Help.

### 4 Restart your computer.

## Mac OS X

### 1 Delete the printer that uses the machine's PPD file from the printer list.

To show the printer list, see step 11 and 12 of "[MAC OS X](#)" (page 1-107).

### 2 Delete the PPD file.

The PPD file has been copied to the following folder on the startup disk.  
[Library] - [Printers] - [PPDs] - [Contents] - [Resources] - [en.lproj]  
Delete the PPD file of the machine from this folder.

### 3 Delete the installation information.

The installation information file has been copied to the following folder on the startup disk.  
[Library] - [Receipts]  
Delete the [MX-PKX.pkg] file from this folder.

## Mac OS 9.0 - 9.2.2

After deleting the icon of the printer that uses the machine's PPD file from the desktop, follow the steps below.

### 1 Download the software and save the extracted files in any folder.

- 2 Double-click the [MacOS] folder.
- 3 Double-click the [Installer] icon (  ).
- 4 Select [Remove] in the Install menu and click the [Remove] button.

# CHAPTER 2

# COPIER

This chapter provides detailed explanations of the procedures for using the copy function.

## BEFORE USING THE MACHINE AS A COPIER

<b>BASE SCREEN OF COPY MODE</b> .....	<b>2-3</b>
<b>COPYING SEQUENCE</b> .....	<b>2-6</b>
<b>ORIGINALS</b> .....	<b>2-9</b>
• STANDARD ORIGINAL PLACEMENT ORIENTATIONS .....	2-9
<b>PAPER TRAYS</b> .....	<b>2-11</b>

## BASIC PROCEDURE FOR MAKING COPIES

<b>MAKING COPIES</b> .....	<b>2-12</b>
• USING THE AUTOMATIC DOCUMENT FEEDER TO MAKE COPIES (1-sided copies of 1-sided originals) .....	2-12
• USING THE DOCUMENT GLASS TO MAKE COPIES (1-sided copy of a 1-sided original) .....	2-14
<b>AUTOMATIC 2-SIDED COPYING</b> .....	<b>2-17</b>
• USING THE AUTOMATIC DOCUMENT FEEDER TO MAKE 2-SIDED COPIES .....	2-17
• USING THE DOCUMENT GLASS TO MAKE 2-SIDED COPIES .....	2-20
<b>CHANGING THE EXPOSURE AND ORIGINAL IMAGE TYPE</b> .....	<b>2-23</b>
• AUTOMATIC ADJUSTMENT OF THE EXPOSURE AND ORIGINAL TYPE .....	2-23
• MANUAL ADJUSTMENT OF THE EXPOSURE AND ORIGINAL TYPE .....	2-23
<b>REDUCTION/ENLARGEMENT/ZOOM</b> .....	<b>2-25</b>
• AUTOMATIC RATIO SELECTION (Auto Image) .....	2-25
• MANUAL RATIO SELECTION (Preset ratios/Zoom) .....	2-26
• ENLARGING/REDUCING THE LENGTH AND WIDTH SEPARATELY (XY Zoom) .....	2-28
<b>ORIGINAL SIZES</b> .....	<b>2-29</b>
• SPECIFYING THE ORIGINAL SIZE .....	2-29
• STORING FREQUENTLY USED ORIGINAL SIZES .....	2-32

<b>OUTPUT</b> .....	<b>2-35</b>
• OUTPUT MODES .....	2-36
<b>MAKING COPIES USING THE BYPASS TRAY</b> .....	<b>2-38</b>

## SPECIAL MODES

<b>SPECIAL MODES</b> .....	<b>2-41</b>
<b>ADDING MARGINS (Margin Shift)</b> .....	<b>2-44</b>
<b>ERASING PERIPHERAL SHADOWS (Erase)</b> .....	<b>2-46</b>
<b>MAKING COPIES IN PAMPHLET FORMAT (Pamphlet Copy)</b> .....	<b>2-48</b>
<b>COPYING A LARGE NUMBER OF ORIGINALS AT ONCE (Job Build)</b> .....	<b>2-51</b>
<b>ADDING INSERTS WHEN COPYING ON TRANSPARENCY FILM (Transparency Inserts)</b> .....	<b>2-53</b>
<b>COPYING TWO ORIGINAL PAGES ONTO ONE SHEET (2in1)</b> .....	<b>2-55</b>
<b>COPYING BOTH SIDES OF A CARD ON ONE SHEET OF PAPER (Card Shot)</b> .....	<b>2-57</b>
<b>PRINTING THE DATE AND A STAMP ON COPIES (Stamp)</b> .....	<b>2-60</b>
• GENERAL PROCEDURE FOR USING STAMP .....	2-61
• ADDING THE DATE TO COPIES (Date) .....	2-64
• STAMPING COPIES (Stamp) .....	2-66
• PRINTING PAGE NUMBERS ON COPIES (Page Numbering) .....	2-68
• PRINTING TEXT ON COPIES (Text) .....	2-71
• CHECKING THE STAMP LAYOUT (Layout) .....	2-75

**[Image Edit] KEY . . . . . 2-77**

- REPEATING PHOTOS ON A COPY  
(Photo Repeat) . . . . . 2-78
- REVERSING THE IMAGE (Mirror Image) . . . . . 2-80
- COPYING IN THE CENTER OF THE  
PAPER (Centering) . . . . . 2-81
- REVERSING BLACK AND WHITE IN A  
COPY (B/W Reverse). . . . . 2-83

**ADJUSTING THE SHARPNESS OF AN  
IMAGE (Sharpness). . . . . 2-85**

**CHECKING COPIES BEFORE PRINTING  
(Proof Copy) . . . . . 2-87**

**CHECKING THE NUMBER OF SCANNED  
ORIGINAL SHEETS BEFORE COPYING  
(Original Count). . . . . 2-90**

**COPYING ORIGINALS OF DIFFERENT  
SIZES (Mixed Size Original) . . . . . 2-91**

**COPYING THIN ORIGINALS (Slow Scan  
Mode) . . . . . 2-94**

**COPYING MULTIPLE BUSINESS CARDS  
(8 Business Cards Layout). . . . . 2-96**

**CONVENIENT COPY FUNCTIONS**

**INTERRUPTING A COPY RUN (Interrupt  
copy). . . . . 2-99**

**CHECKING A PREVIEW IMAGE OF A COPY  
(Preview) . . . . . 2-101**

- PREVIEW SCREEN. . . . . 2-103

**JOB STATUS SCREEN . . . . . 2-104**

- JOB QUEUE SCREEN AND COMPLETED  
JOB SCREEN. . . . . 2-105
- CANCELING A JOB THAT IS WAITING IN  
THE QUEUE. . . . . 2-107
- GIVING PRIORITY TO A JOB IN THE  
QUEUE. . . . . 2-108
- CHECKING INFORMATION ON A COPY  
JOB WAITING IN THE QUEUE . . . . . 2-109

**STORING COPY OPERATIONS (Job  
Programs) . . . . . 2-110**

- STORING (EDITING/DELETING) A JOB  
PROGRAM. . . . . 2-111

# BEFORE USING THE MACHINE AS A COPIER

This section provides information that you should know before using the machine as a copier.

## BASE SCREEN OF COPY MODE

Touch the [COPY] key in the touch panel to open the base screen of copy mode.

The base screen shows messages and keys necessary for copying, and settings that have been selected.

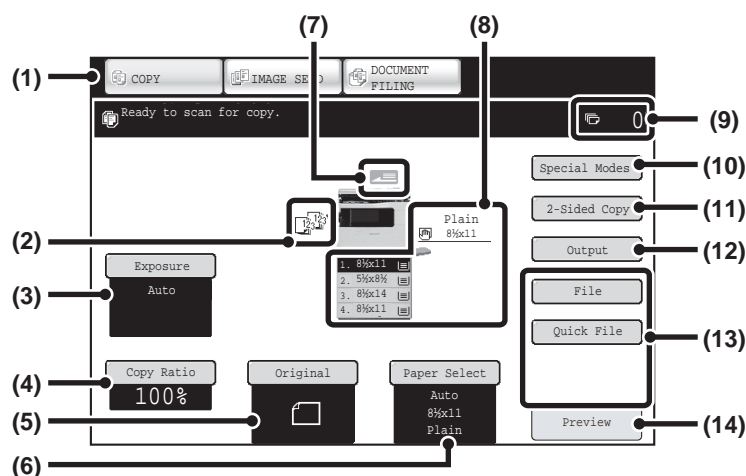

### (1) Mode Select keys

Use these keys to switch between copy, image send, and document filing modes.

If you wish to switch to copy mode, touch the [COPY] key.

### (2) Output display

When one or more output functions such as sort, group, or staple sort have been selected, this shows the icons of the selected functions.

➤ [OUTPUT](#) (page 2-35)

### (3) [Exposure] key

This shows the current copy exposure and original type settings. Touch this key to change the exposure or original type setting.

➤ [CHANGING THE EXPOSURE AND ORIGINAL IMAGE TYPE](#) (page 2-23)

### (4) [Copy Ratio] key

This shows the current copy ratio. Touch this key to adjust the copy ratio.

➤ [REDUCTION/ENLARGEMENT/ZOOM](#) (page 2-25)

### (5) [Original] key

Touch to specify the original size.

If the original size displayed in this key is different from the size of the original you placed, or if the original size is not displayed, be sure to touch this key and specify the correct size.

If using the automatic document feeder with the MX-B402SC, also touch the key when setting the original output destination. The set original output destination is displayed in this key.

➤ [ORIGINAL SIZES](#) (page 2-29)

### (6) [Paper Select] key

Touch this key to change the paper (tray) that is used.

The tray, paper size, and paper type will appear. Trays 1 to 4 can also be selected in the paper size display to open the same screen.

➤ [PAPER TRAYS](#) (page 2-11)

### (7) Original feed display

This appears when an original is inserted in the automatic document feeder.

**(8) Paper size display**

This shows the size of paper loaded in each tray.  
 For the bypass tray, the paper type appears above the paper size.  
 The selected tray is highlighted.  
 The approximate amount of paper in each tray is indicated by . Trays 1 to 4 can be selected to open the same screen as when the [Paper Select] key is selected.

[PAPER TRAYS](#) (page 2-11)

**(9) Number of copies display**

This shows the number of copies set.

**(10) [Special Modes] key**

Touch this key to select special modes such as Margin Shift and Edge Erase.

[SPECIAL MODES](#) (page 2-41)

**(11) [2-Sided Copy] key**

Touch this key to select the 2-sided copying function.

[AUTOMATIC 2-SIDED COPYING](#) (page 2-17)

**(12) [Output] key**

Touch this to select an output function such as sort, group, offset, or staple sort.

[OUTPUT](#) (page 2-35)

**(13) Customized keys**

The keys that appear here can be changed to show settings or functions that you prefer. The following keys appear by factory default:

[Customizing displayed keys](#) (page 2-5)

**[File] key, [Quick File] key**

Touch one of these keys to use the File function or Quick File function of document filing mode. These are the same [File] and [Quick File] keys that appear when the [Special Modes] key is touched. For information on the document filing function, see "6. DOCUMENT FILING".

**(14) [Preview] key**

Touch to view a preview image of a copy in the touch panel before printing the copy.

[CHECKING A PREVIEW IMAGE OF A COPY \(Preview\)](#) (page 2-101)

The screen explained in this section appears when 500-sheet paper feed units and finisher are installed. The image will vary depending on the equipment installed.

## Tray during paper feeding

Do not pull out a tray while paper is being fed from the tray. This will cause a paper misfeed.

### Identifying the tray that is being used to feed paper

- (1) While paper is feeding, the job status display of the system bar on the touch panel screen will show the number of the tray that is being used to feed paper.
- (2) The tray being used to feed paper also appears in green in the paper size display in the base screen on the touch panel.

**Base screen**

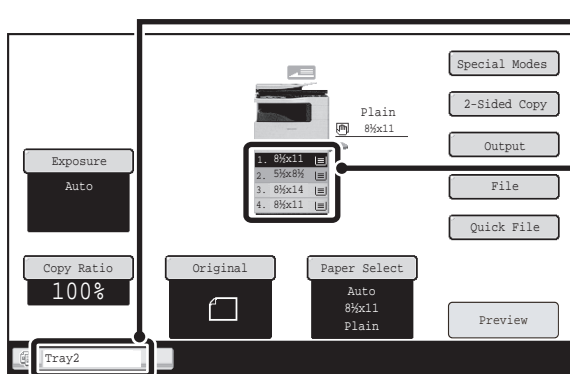



- (1) **Job status display on the system bar**  
Shows the number of the tray being used to feed paper.
- (2) **Paper size display**  
Shows the tray being used to feed paper in green.

## Customizing displayed keys

Special mode keys and other keys can be displayed in the base screen. By assigning frequently used functions to these keys, you can access the functions with a single touch. To change the function that is assigned to a key, use "Customize Key Setting" in the Web pages.

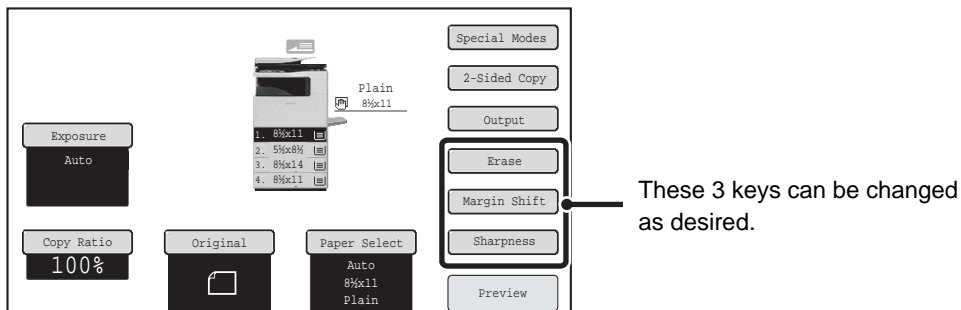
When "Erase", "Margin Shift", and "Sharpness" are assigned to the customized keys



 **System Settings (Administrator): Customize Key Setting**  
 Registration is performed in [System Settings] - [Operation Settings] - "Customize Key Setting" in the Web page menu.

## Checking what special modes are selected

The  key appears in the base screen when one or more special modes are selected.

The  key can be touched to display the selected special modes. To close the screen, touch the [OK] key.

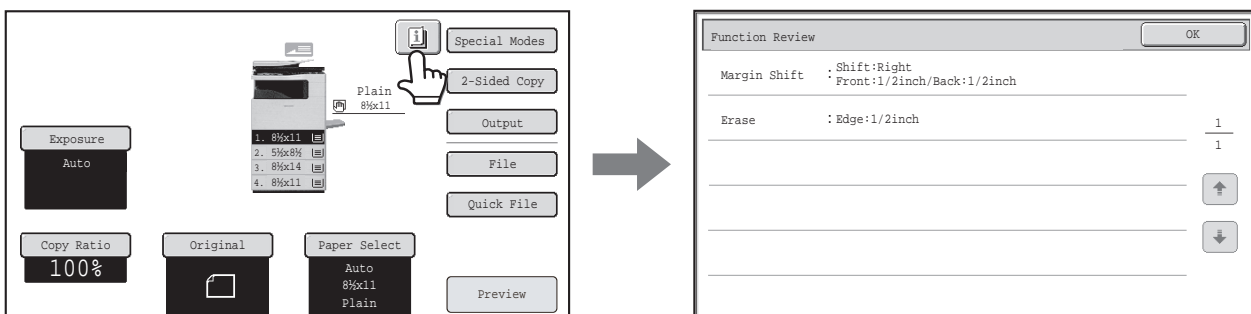

# COPYING SEQUENCE

This section explains the basic procedure for copying. Select settings in the order shown below to ensure that the copy operation takes place smoothly.

For detailed procedures for selecting the settings, see the explanation of each setting in this chapter.

## Place the original.

Place the original in the automatic document feeder tray, or on the document glass.

Place the original in the automatic document feeder.

 [PLACING ORIGINALS IN THE AUTOMATIC DOCUMENT FEEDER](#) (page 1-37)

\* Depending on the copy functions used, there are also cases where functions are selected before the original is placed.



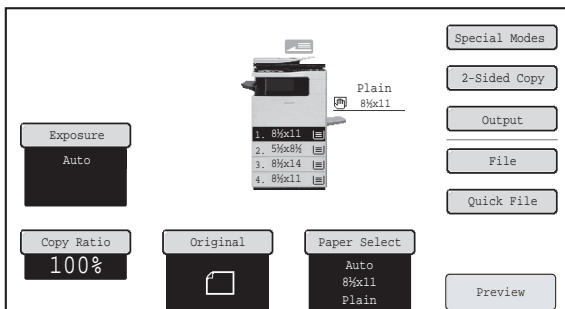

## Basic copy settings



Select the basic copy settings.

The main settings are as follows:

- Exposure and original type  [CHANGING THE EXPOSURE AND ORIGINAL IMAGE TYPE](#) (page 2-23)
- Copy ratio  [REDUCTION/ENLARGEMENT/ZOOM](#) (page 2-25)
- Original size  [ORIGINAL SIZES](#) (page 2-29)
- Paper Settings  [PAPER TRAYS](#) (page 2-11)



## 2-sided copy settings

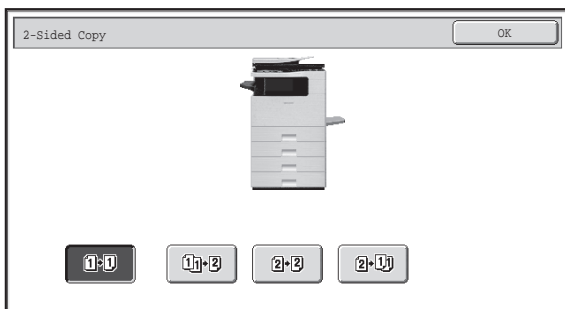

Select settings as needed for 2-sided copying and 2-sided scanning of the original.

 [AUTOMATIC 2-SIDED COPYING](#) (page 2-17)





## Output settings

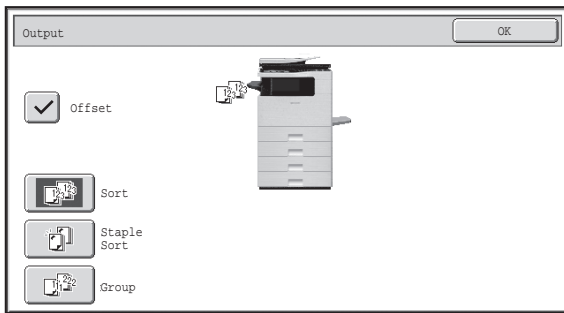

Select copy output settings.

The main settings are as follows:

- Sort mode [Sort mode](#) (page 2-36)
- Group mode [Group mode](#) (page 2-36)
- Offset mode [Offset function](#) (page 2-36)
- Staple sort mode
  - [Staple sort function](#) (page 2-37)



## Special mode settings

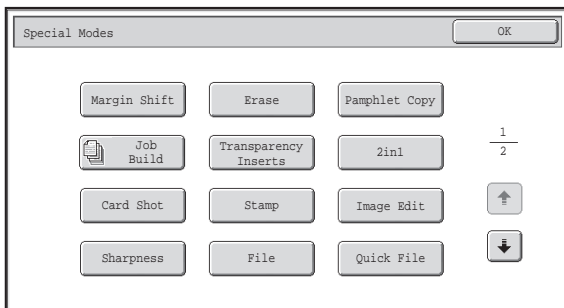

Select special modes such as "Margin Shift" and "Erase".

[SPECIAL MODES](#) (page 2-41)



## Number of copies (sets) setting

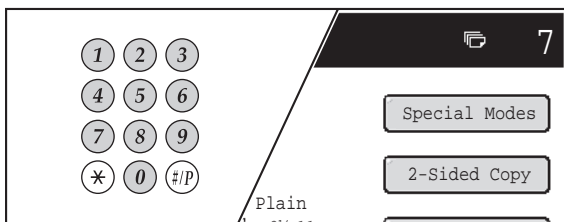



Set the number of copies (number of sets).



## Start copying.

Start scanning the original(s) and making copies.  
Press the [START] key.





- When one or more special modes are selected, the  key appears in the base screen. Touch the  key to display a list of the selected special modes. This lets you check what special modes are selected and the settings of each mode.  
 [Checking what special modes are selected](#) (page 2-5)
- To store a copy job using the document filing function, select copy settings and then touch the [File] key or the [Quick File] key.



**To cancel all settings, press the [CLEAR ALL] key ().**

When the [CLEAR ALL] key () is pressed, all settings selected to that point are cleared and you will return to the base screen.

**To stop scanning of the original and copying, press the [STOP] key ().**

When the [STOP] key () is pressed, a message will appear asking you if you want to cancel the job. Touch the [Yes] key in the message screen.

# ORIGINALS

## STANDARD ORIGINAL PLACEMENT ORIENTATIONS

Place the original so that the top and bottom edges are oriented as shown below. For more information on placing the original, see "ORIGINALS" (page 1-37) in "1. BEFORE USING THE MACHINE".

Document feeder tray  
MX-B402

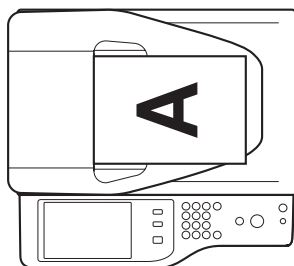

Portrait original

Place the original face down in the left center position of the document glass

Document glass

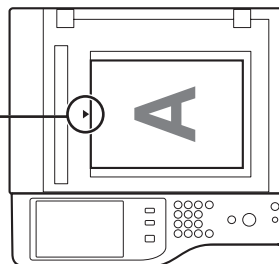

MX-B402SC

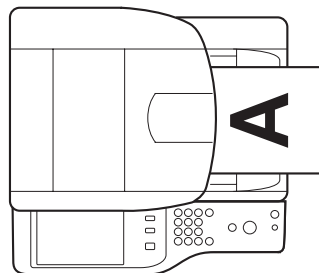

When using the below functions in copy mode, place the original so that the top of the image is to the right.

- Staple sort
- Pamphlet copy
- 2in1
- Stamp

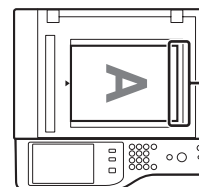

Top of image to the right

Landscape original

Document feeder tray

**MX-B402**

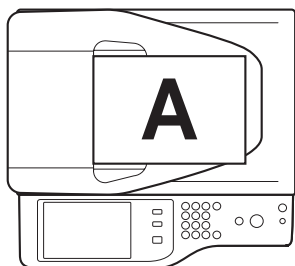

Document glass

Place the original face down in the left center position of the document glass

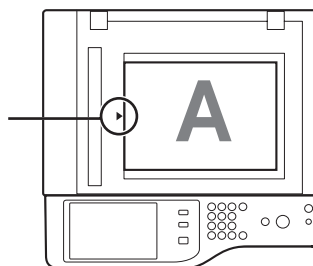

**MX-B402SC**

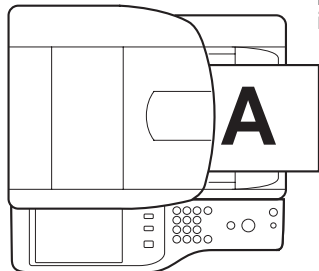

When using the staple sort function, place the original so that the top of the image is toward you.

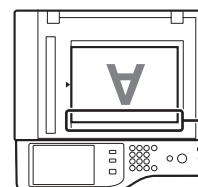

Top of image toward you

**MX-B402**

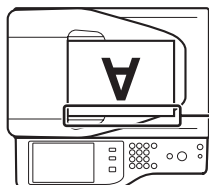

Top of image toward you

**MX-B402SC**

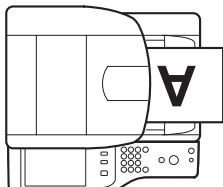

# PAPER TRAYS

The machine is set to automatically select a tray that has the same size of paper as the size of the placed original (automatic paper tray selection).

If the correct paper size is not selected or you wish to change the paper size, you can select the paper tray manually.

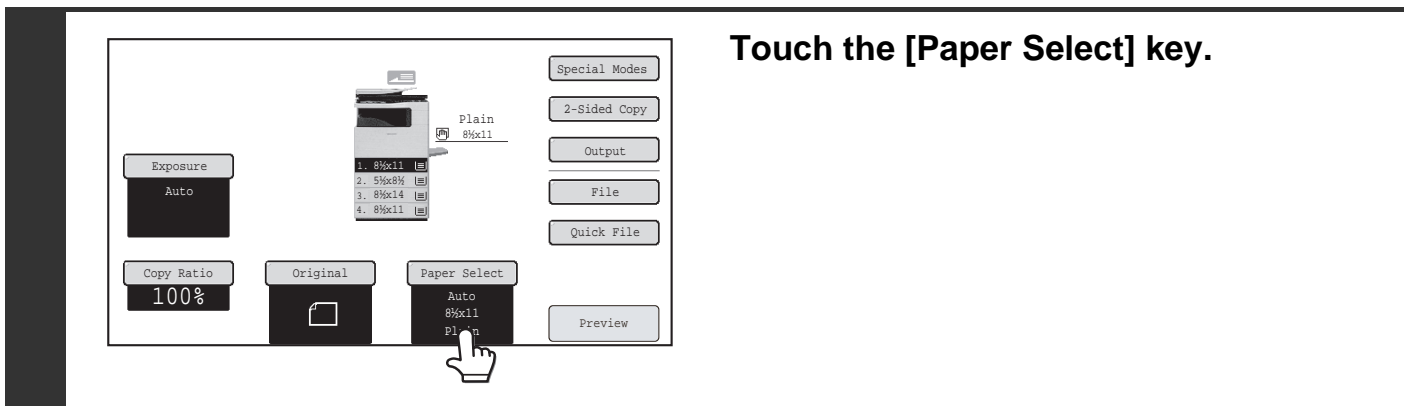

Touch the [Paper Select] key.

1



You can also touch the paper size display (A) to open the paper tray settings.

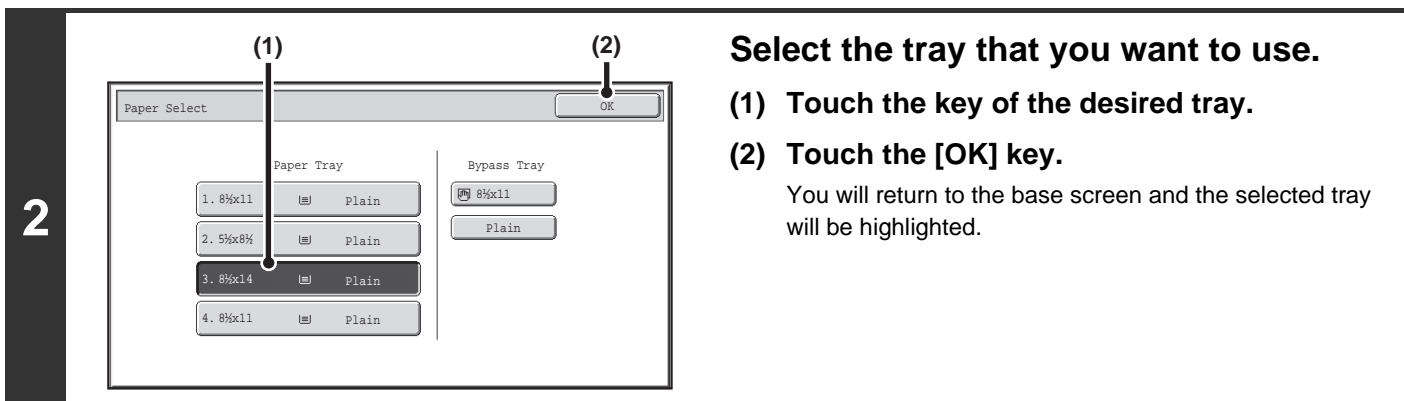
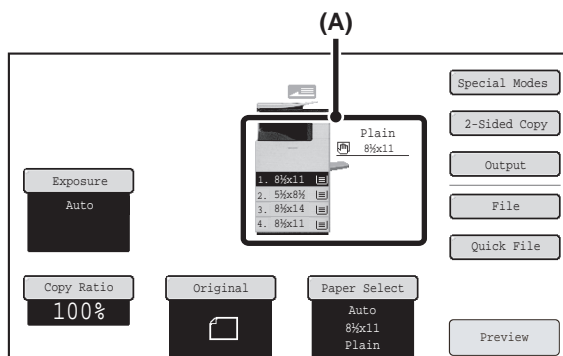

Select the tray that you want to use.

(1) Touch the key of the desired tray.

(2) Touch the [OK] key.

You will return to the base screen and the selected tray will be highlighted.

If the selected tray runs out of paper during a copy job and there is another tray that has the same size and type of paper, that tray will be automatically selected and the copy job will continue.

To return to automatic paper tray selection after selecting a tray manually, press the [CLEAR ALL] key (CA).

**System Settings (Administrator): Initial Status Settings (Paper Tray)**  
Use this setting to change the tray that is selected by default.

# BASIC PROCEDURE FOR MAKING COPIES

This section explains the basic procedures for making copies, including selection of the copy ratio and other copy settings.

## MAKING COPIES

### USING THE AUTOMATIC DOCUMENT FEEDER TO MAKE COPIES (1-sided copies of 1-sided originals)

This section explains how to make copies (1-sided copies of 1-sided originals) using the automatic document feeder.

#### 1 Place the originals face up in the document feeder tray with the edges aligned evenly.

1

Place the original in the automatic document feeder.

 [PLACING ORIGINALS IN THE AUTOMATIC DOCUMENT FEEDER](#) (page 1-37)

2

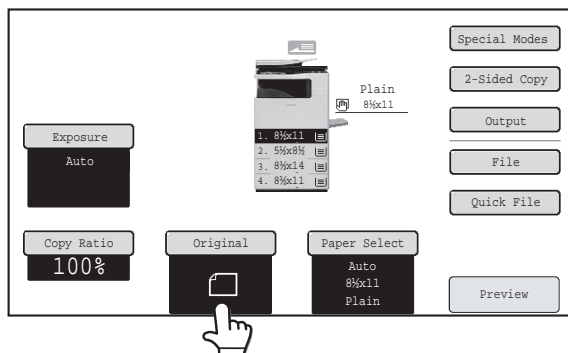

Touch the [Original] key.

3

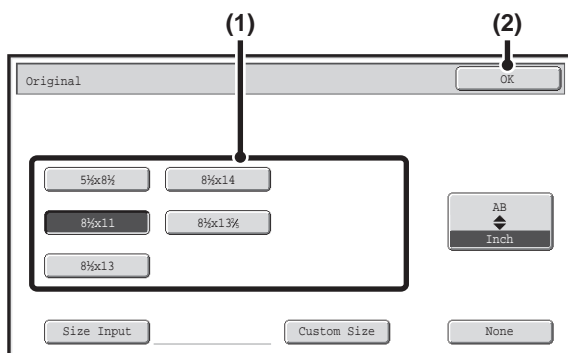

Specify the original size.

(1) Touch the appropriate original size key.

(2) Touch the [OK] key.



When using the MX-B402SC, placing an AB size or non-standard size original, specify the original size as explained in "ORIGINAL SIZES" (page 2-29).

4

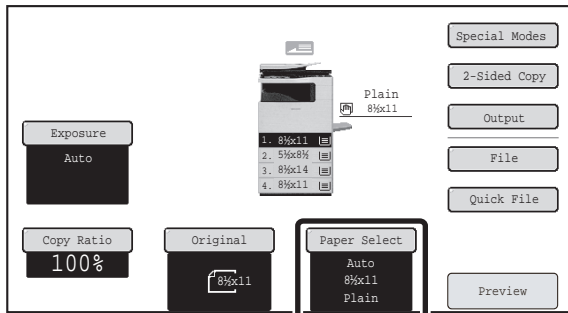

**Check the paper to be used.**

Make sure that the desired paper (tray) is selected.  
To change the paper (tray), touch the [Paper Select] key.  
➡ [PAPER TRAYS](#) (page 2-11)



For some original size settings, the same size of paper as the original may not be automatically selected. In this case, manually change the paper size.

5

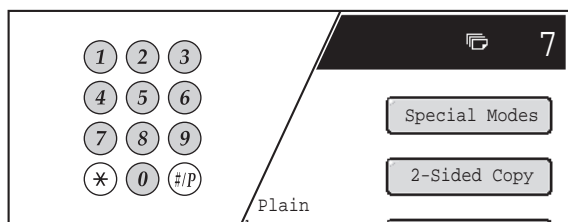

**Set the number of copies (number of sets) with the numeric keys.**



- Up to 999 copies (sets) can be set.
- A single copy can be made even if "0" appears for the number of copies.



**If an incorrect number of copies is set...**  
Press the [CLEAR] key (Ⓢ) and then enter the correct number.

6

**Press the [START] key.**



**To cancel scanning of the original and copying...**  
Press the [STOP] key (Ⓢ).

# USING THE DOCUMENT GLASS TO MAKE COPIES (1-sided copy of a 1-sided original)

To make a copy of a book or other thick original that cannot be scanned with the automatic document feeder, open the automatic document feeder and place the original on the document glass. This section explains how to make a copy (1-sided copy of a 1-sided original) using the document glass.

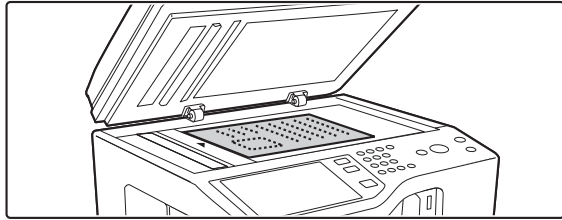

Open the automatic document feeder, place the original face down on the document glass, and then gently close the automatic document feeder.

## Portrait original

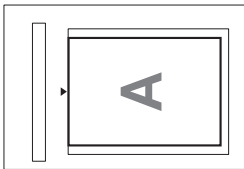

Align the top edge of the original against the side of the document glass with the scale.

## Landscape original

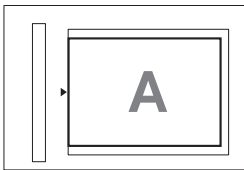

Align the right side of the original against the side of the document glass with the scale.

## Document glass scale

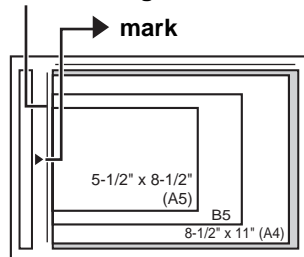

- The maximum original size that can be placed on the document glass is 8-1/2" x 11" (A4).
- Align the middle of the original with the tip of the ► mark.
- Place the original in the appropriate position for its size as shown above.
- After placing the original, be sure to close the automatic document feeder. If left open, parts outside of the original will be copied black, causing excessive use of toner.

1

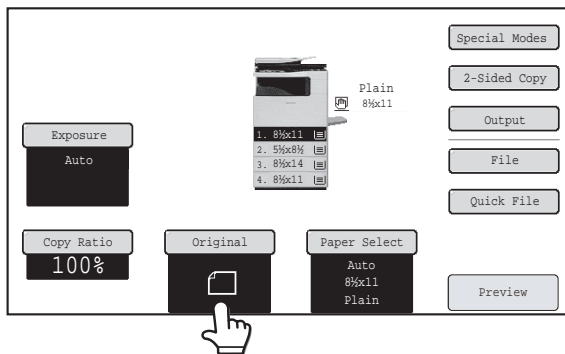

Touch the [Original] key.

2



3

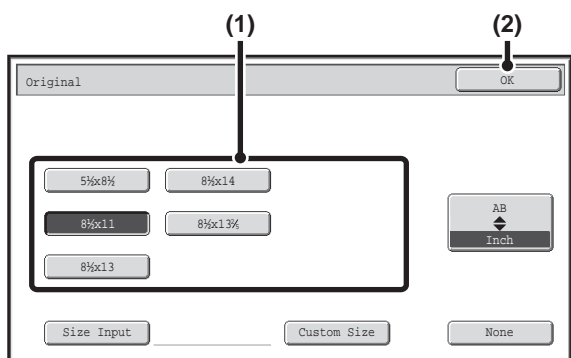

**Specify the original size.**

- (1) Touch the appropriate original size key.
- (2) Touch the [OK] key.



When using the MX-B402SC, placing an AB size or non-standard size original, specify the original size as explained in "ORIGINAL SIZES" (page 2-29).

4

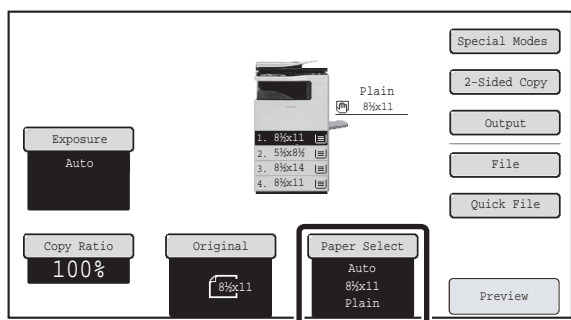

**Check the paper to be used.**

Make sure that the desired paper (tray) is selected. To change the paper (tray), touch the [Paper Select] key. [PAPER TRAYS](#) (page 2-11)



For some original size settings, the same size of paper as the original may not be automatically selected. In this case, manually change the paper size.

5

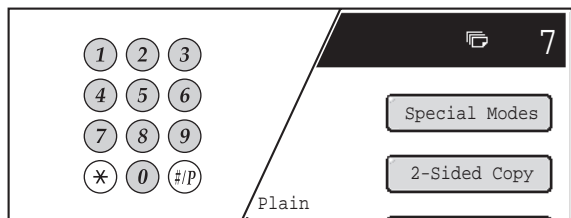

**Set the number of copies (number of sets) with the numeric keys.**



- Up to 999 copies (sets) can be set.
- A single copy can be made even if "0" appears for the number of copies.



**If an incorrect number of copies is set...**  
Press the [CLEAR] key (C) and then enter the correct number.

6

**Press the [START] key.**

Normally copying will start. Depending on the copy settings (2-sided copying, etc.), copying may not begin until all originals have been scanned. In this case, go to the next step.

7

**Remove the original and place the next original, and then press the [START] key.**

Repeat this step until all originals have been scanned.

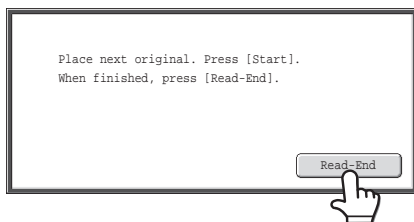

**Touch the [Read-End] key.**



**To cancel scanning of the original and copying...**

Press the [STOP] key (⏹).

# AUTOMATIC 2-SIDED COPYING

## USING THE AUTOMATIC DOCUMENT FEEDER TO MAKE 2-SIDED COPIES

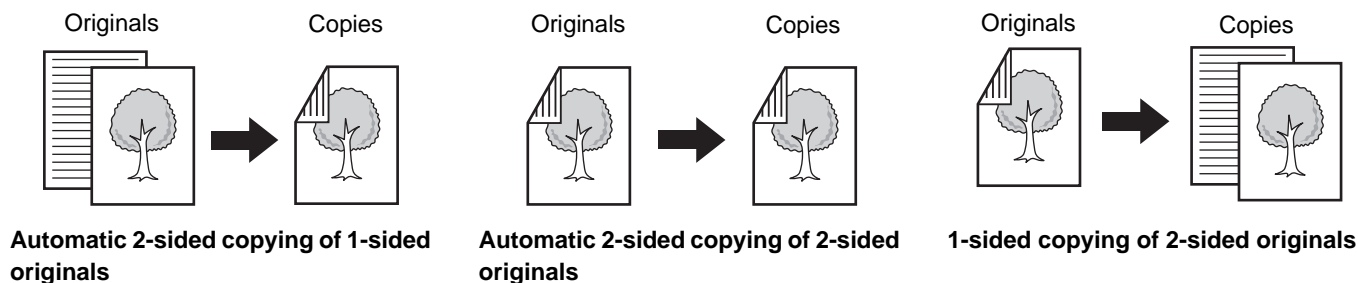

**1** Place the originals face up in the document feeder tray with the edges aligned evenly.

Place the original in the automatic document feeder.

[PLACING ORIGINALS IN THE AUTOMATIC DOCUMENT FEEDER](#) (page 1-37)

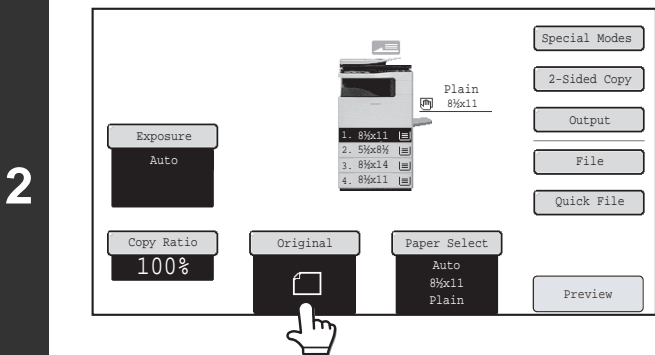

Touch the [Original] key.

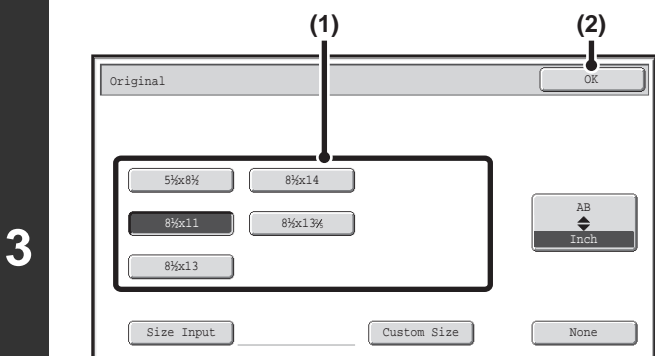

Specify the original size.

(1) Touch the appropriate original size key.

(2) Touch the [OK] key.

When using the MX-B402SC, placing an AB size or non-standard size original, specify the original size as explained in "[ORIGINAL SIZES](#)" (page 2-29).

4

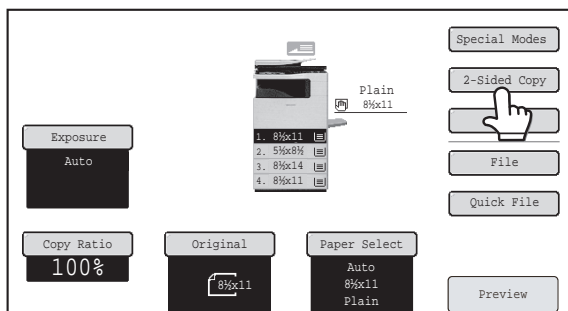

Touch the [2-Sided Copy] key.

5

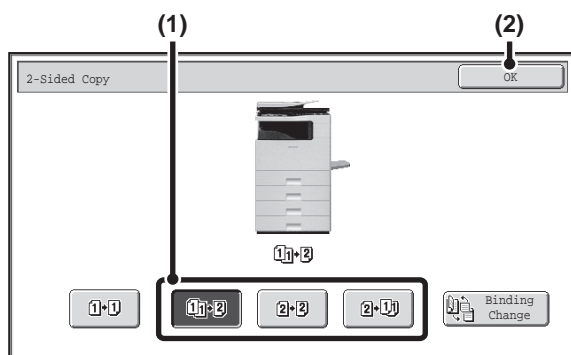

Select the 2-sided copy mode.

(1) Touch the key of the desired mode.

- : Automatic 2-sided copying of 1-sided originals
- : Automatic 2-sided copying of 2-sided originals
- : 1-sided copying of 2-sided originals

(2) Touch the [OK] key.



To make 2-sided copies of a 1-sided portrait original placed horizontally, or to invert the reverse side with respect to the front side when copying a 2-sided original, touch the [Binding Change] key.

[Using the \[Binding Change\] key](#) (page 2-19)

6

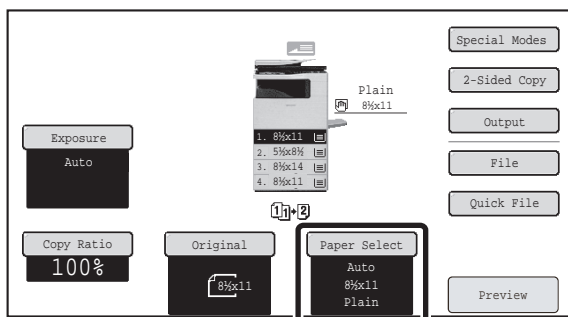

Check the paper to be used.

Make sure that the desired paper (tray) is selected. To change the paper (tray), touch the [Paper Select] key.

[PAPER TRAYS](#) (page 2-11)



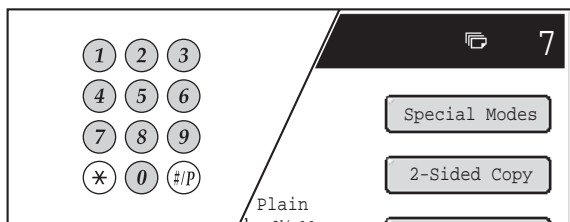

For some original size settings, the same size of paper as the original may not be automatically selected. In this case, manually change the paper size.

7



Set the number of copies (number of sets) with the numeric keys.

- 
  - Up to 999 copies (sets) can be set.
  - If you are only making a single copy, the copy can be made with the copy number display showing "0".
- 

**If an incorrect number of copies is set...**  
Press the [CLEAR] key (C) and then enter the correct number.



8

Press the [START] key.

- 

**To cancel scanning of the original and copying...**  
Press the [STOP] key (⊘).

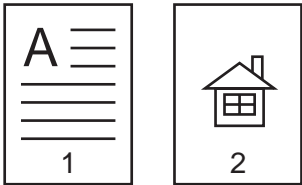
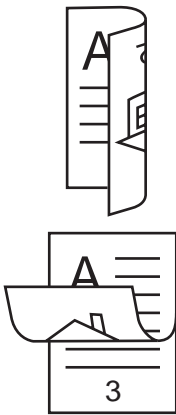
Using the [Binding Change] key

Originals	Binding Change is used (For a tablet binding)	Binding Change is not used (For a booklet binding)
	 <p>The reverse side is upside down.</p> <p>Select this when the pages will be bound into a tablet.</p>	 <p>The reverse side is not upside down.</p> <p>Select this when the pages will be bound into a booklet.</p>

# USING THE DOCUMENT GLASS TO MAKE 2-SIDED COPIES

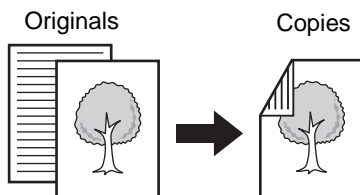

Automatic 2-sided copying of 1-sided originals

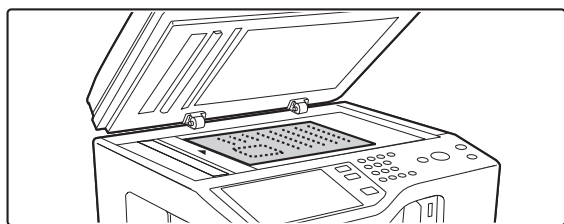

Open the automatic document feeder, place the original face down on the document glass, and then gently close the automatic document feeder.

1

### Portrait original

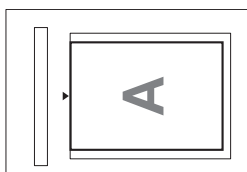

Align the top edge of the original against the side of the document glass with the scale.

### Landscape original

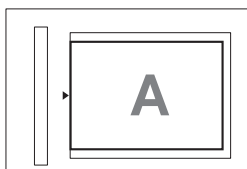

Align the right side of the original against the side of the document glass with the scale.

### Document glass scale

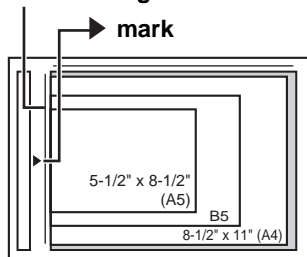

- The maximum original size that can be placed on the document glass is 8-1/2" x 11" (A4).
- Align the middle of the original with the tip of the ► mark.
- Place the original in the appropriate position for its size as shown above.
- After placing the original, be sure to close the automatic document feeder. If left open, parts outside of the original will be copied black, causing excessive use of toner.

2

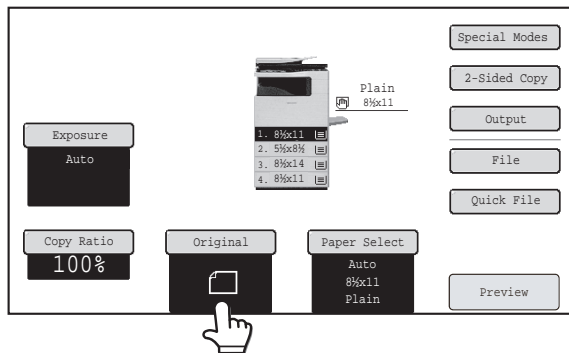

Touch the [Original] key.

3

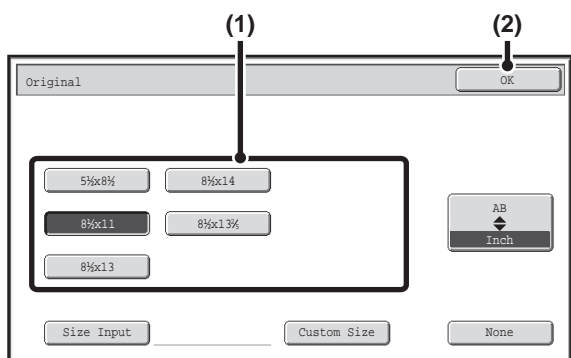

**Specify the original size.**

- (1) Touch the appropriate original size key.
- (2) Touch the [OK] key.



When using the MX-B402SC, placing an AB size or non-standard size original, specify the original size as explained in "ORIGINAL SIZES" (page 2-29).

4

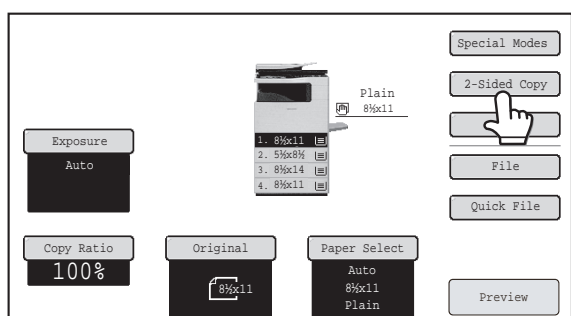

**Touch the [2-Sided Copy] key.**

5

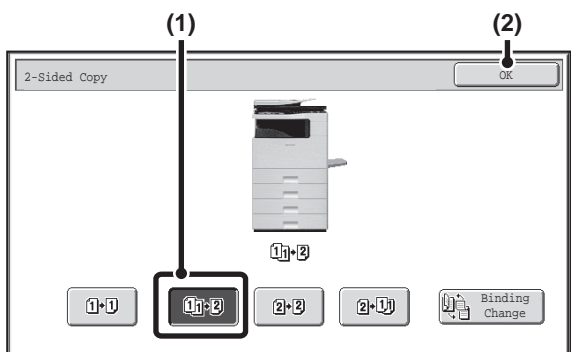

**Select the 2-sided copy mode.**

- (1) Touch the [1-Sided to 2-Sided] key.
- (2) Touch the [OK] key.



The [2-Sided to 2-Sided] key and [2-Sided to 1-Sided] key cannot be used when copying from the document glass.

6

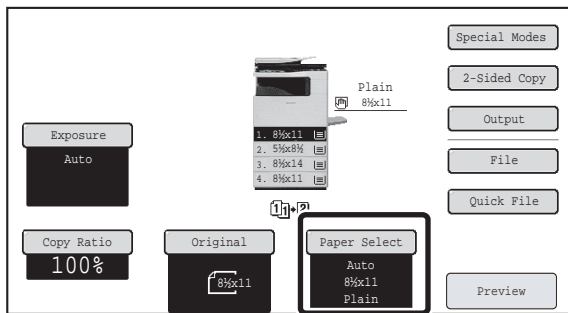

### Check the paper to be used.

Make sure that the desired paper (tray) is selected. To change the paper (tray), touch the [Paper Select] key. [PAPER TRAYS](#) (page 2-11)

For some original size settings, the same size of paper as the original may not be automatically selected. In this case, manually change the paper size.

7

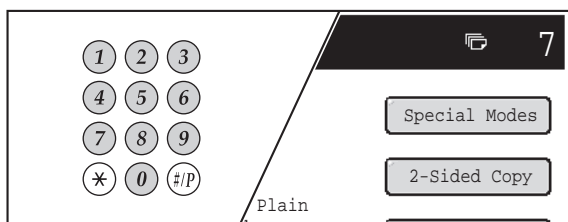

### Set the number of copies (number of sets) with the numeric keys.

- Up to 999 copies (sets) can be set.
- A single copy can be made even if "0" appears for the number of copies.

**If an incorrect number of copies is set...**  
Press the [CLEAR] key () and then enter the correct number.

8

### Press the [START] key.

Scanning begins.

9

### Remove the original and place the next original, and then press the [START] key.

Repeat this step until all originals have been scanned.

10

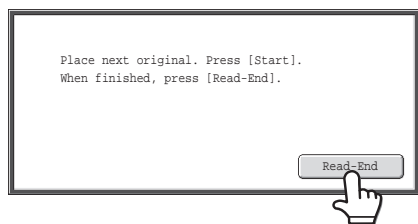

### Touch the [Read-End] key.

**To cancel scanning of the original and copying...**  
Press the [STOP] key ()

**System Settings (Administrator): Initial Status Settings (2-Sided Copy)**  
The default 2-sided copy mode can be changed.



# CHANGING THE EXPOSURE AND ORIGINAL IMAGE TYPE

The exposure and original image type can be selected to obtain a clear copy.

## AUTOMATIC ADJUSTMENT OF THE EXPOSURE AND ORIGINAL TYPE

Automatic exposure adjustment operates by default to automatically adjust the exposure level and original type as appropriate for the original being copied. ("Auto" is displayed.)

This function automatically adjusts the image during copying to obtain the most suitable copy.

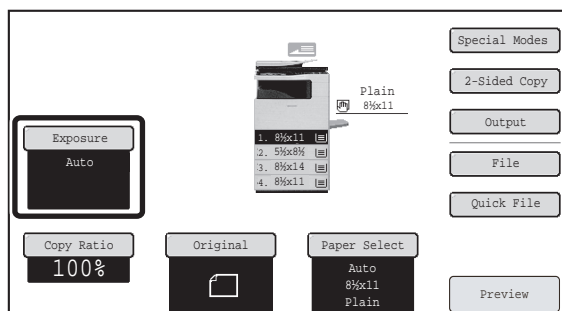

## MANUAL ADJUSTMENT OF THE EXPOSURE AND ORIGINAL TYPE

If you wish to select the original type or manually adjust the exposure, touch the [Exposure] key in the base screen of copy mode and follow the steps below.

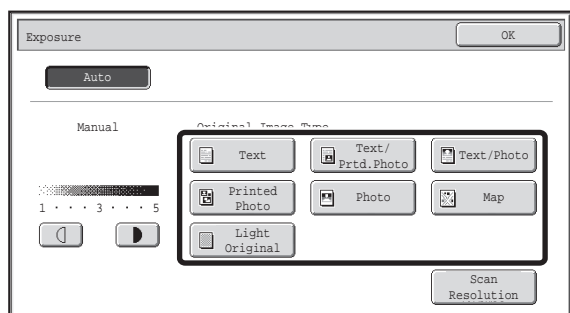

### Select the original image type.

The image will be adjusted appropriately for the original type. Select the image type that best matches your original.

#### ● Original image type select keys



1

Mode	Description
Text	Use this mode for regular text documents.
Text/Prt'd. Photo	This mode provides the best balance for copying an original which contains both text and printed photographs, such as a magazine or catalogue.
Text/Photo	This mode provides the best balance for copying an original which contains both text and photographs, such as a text document with a photo pasted on.
Printed photo	This mode is best for copying printed photographs, such as photos in a magazine or catalogue.
Photo	Use this mode to copy photos.
Map	This mode is best for copying the light color shading and fine text found on most maps.
Light Original	Use this mode for originals with light pencil writing.

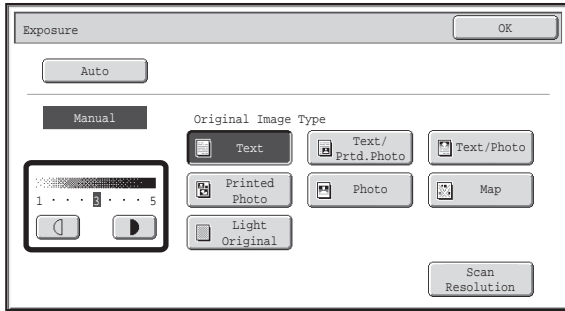
2



### Adjust the exposure level.

Touch the  key to make the copy darker.  
 Touch the  key to make the copy lighter.



#### Guidelines for the exposure level when [Text] is selected:

- 1 to 2: Dark originals such as a newspaper
- 3: Normal density originals
- 4 to 5: Originals written in pencil or light colored text

3

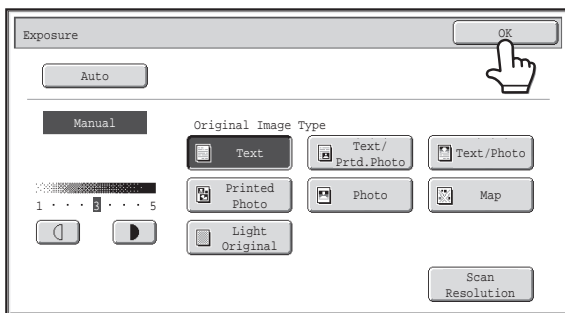

### Touch the [OK] key.



- **If [Auto] is selected but the darkness or lightness of the image does not seem quite right...**  
 If the image seems too light or too dark when [Auto] is selected, the exposure level can be adjusted using "Copy Exposure Adjustment" in the system settings (administrator).
- **To change the resolution...**  
 When making a full-size copy, you can press the [Scan Resolution] key to select the scanning resolution. The numbers that allow selection of the document glass are different from the numbers that allow selection of the automatic document feeder.



- **System Settings (Administrator): Initial Status Settings (Exposure Type)**  
 This is used to change the default original image type.
- **System Settings (Administrator): Copy Exposure Adjustment**  
 The exposure level used for automatic exposure adjustment can be adjusted.
- **System Settings (Administrator): 600dpi x 600dpi Scanning Mode for Document Feeder / Quick Scan from Document Glass**  
 The default resolution setting can be changed.

# REDUCTION/ENLARGEMENT/ZOOM

## AUTOMATIC RATIO SELECTION (Auto Image)

This section explains the automatic ratio selection function (Auto Image), which automatically selects the ratio to match the paper size.

When the paper tray is manually changed, the [Auto Image] key appears in the base screen of copy mode. Touch the [Auto Image] key to have the reduction or enlargement ratio automatically selected based on the original size and the selected paper size.

First place the original and select the paper tray, and then touch the [Auto Image] key.

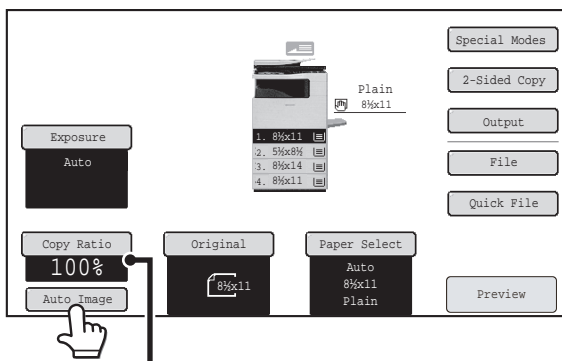

The selected ratio will appear in the ratio display.



For a non-standard size original, the size must be entered in order to use Auto Image.



- **To cancel automatic ratio selection...**

Touch the [Auto Image] key so that it is no longer highlighted.

- **To return the ratio to 100%...**

To return the ratio setting to 100%, touch the [Copy Ratio] key to display the ratio menu and then touch the [100%] key.



**System Settings (Administrator): Initial Status Settings (Copy Ratio)**



This is used to change the default copy ratio.

# MANUAL RATIO SELECTION (Preset ratios/Zoom)

Touch the [Copy Ratio] key in the base screen of copy mode to select one of two preset enlargement ratios or three preset reduction ratios (maximum 200%, minimum 50%).

In addition, the zoom keys can be used to select any ratio from 50% to 200% in increments of 1%.

## Set the ratio.

Touch a preset ratio key and/or the zoom keys to set the ratio. There are two setting screens. Use the   keys to switch between the screens.

### ● 1st screen

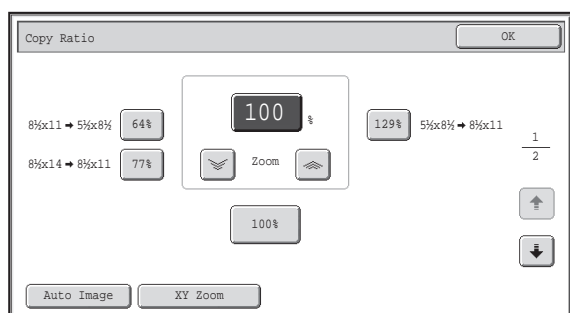

- Enlargement keys (1 ratio): 129%
- Reduction keys (2 ratios): 64% and 77%
- [100%] key

### ● 2nd screen

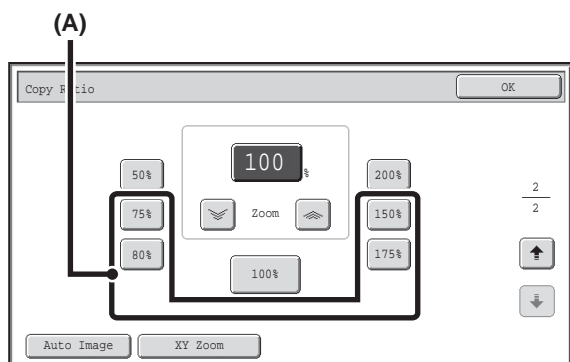







- Enlargement keys (1 to 3 ratios)  
200%, any ratio (max. of two)
- Reduction keys (1 to 3 ratios)  
50%, any ratio (max. of two)
- [100%] key



#### • (A) keys

The keys marked (A) can be set to show any ratio using "Add or Change Extra Preset Ratios" in the system settings (administrator).

- To quickly select a ratio, touch a reduction or enlargement key to select a ratio close to the desired ratio and then use the zoom keys for fine adjustment.
- The zoom keys can be used to select any ratio from 50% to 200% in increments of 1%.  
Touch the  key to increase the ratio, or the  key to decrease the ratio. (If you continue to touch the  /  key, the ratio will change automatically. After 3 seconds, the ratio will change rapidly.)
- As an alternative to touching the   keys, you can also directly touch the numeric value display key and change the value with the numeric keys.
- If the message "Image is larger than the copy paper." appears when an enlargement ratio is selected, the image may not fit on the paper.

2

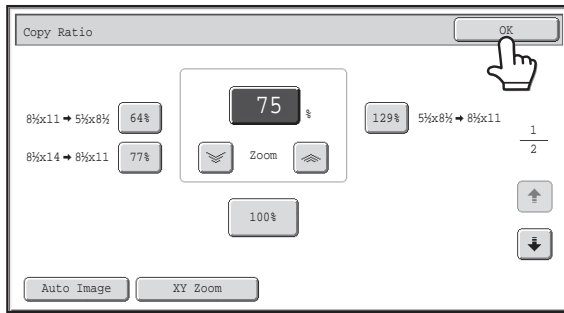

### Touch the [OK] key.

After touching the [OK] key, make sure that a paper size suitable for the ratio is selected.

 When the automatic document feeder is used, the vertical and horizontal ratio selection ranges are both 50% to 200%.

 **To return the ratio to 100%...**  
To return the ratio setting to 100%, touch the [Copy Ratio] key to display the ratio menu and then touch the [100%] key.

 **System Settings (Administrator): Add or Change Extra Preset Ratios**  
Two enlargement preset ratios (101% to 200%) and two reduction preset ratios (50% to 99%) can be added. An added preset ratio can also be changed.

# ENLARGING/REDUCING THE LENGTH AND WIDTH SEPARATELY (XY Zoom)

The XY Zoom feature allows the horizontal and vertical copy ratios to be changed separately. Both the horizontal and vertical ratios can be set from 50% to 200% in increments of 1%. Touch the [Copy Ratio] key in the base screen of copy mode and then follow the steps below.

**When 50% is selected for the horizontal ratio and 70% is selected for the vertical ratio**

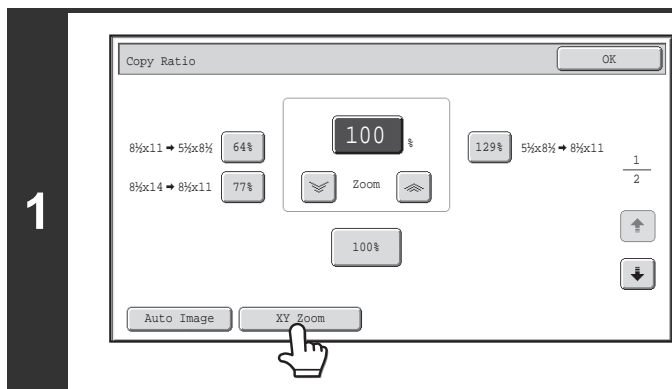
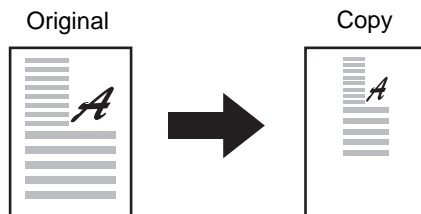

Touch the [XY Zoom] key.

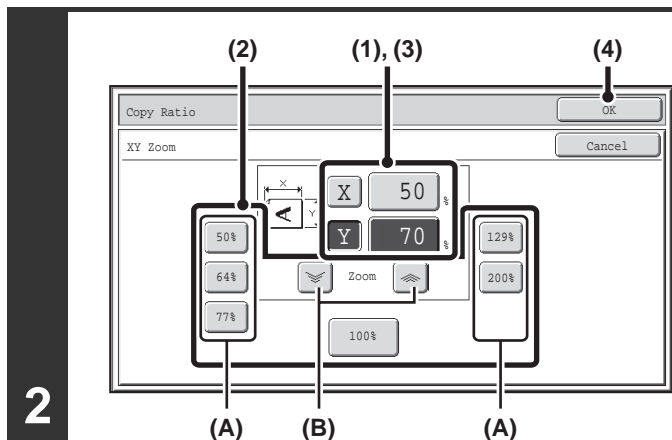

**Set the horizontal and vertical ratios.**

- (1) Touch the [X] key.  
The [X] key will be highlighted and the horizontal ratio can be set.
- (2) Touch one of the preset ratio keys (A) and the zoom keys (B) to set the X (horizontal) ratio.  
(A) A touched preset ratio key will not be highlighted.  
(B) The zoom keys can be touched to set the ratio from 50% to 200% in increments of 1%.
- (3) Touch the [Y] key and set the Y (vertical) ratio in the same way as the [X] key.
- (4) Touch the [OK] key.  
After touching the [OK] key, make sure that a paper size suitable for the ratio is selected.

- To quickly select a ratio, touch a preset ratio key (A) to select a ratio close to the desired ratio and then use the zoom keys (B) for fine adjustment.
- As an alternative to touching the keys, you can also directly touch the numeric value display key and change the value with the numeric keys.

When the automatic document feeder is used, the vertical and horizontal ratio selection ranges are both 50% to 200%.

**To cancel an XY zoom setting...**  
To cancel an XY Zoom setting, touch the [XY Zoom] key or the [Cancel] key.

# ORIGINAL SIZES

## SPECIFYING THE ORIGINAL SIZE

The original size is set in "Default original size setting" in the system settings (administrator), and the setting appears in the [Original] key. This section explains the procedure for specifying the setting when the original size is different from size shown in the [Original] key.

Touch the [Original] key and perform the following.

### Specifying an inch original size

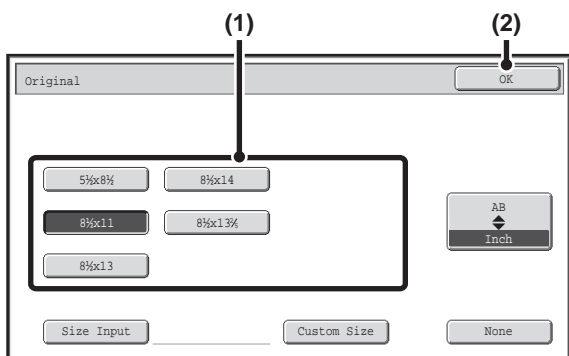

- (1) Touch the appropriate original size key.
- (2) Touch the [OK] key.

### Specifying an AB original size

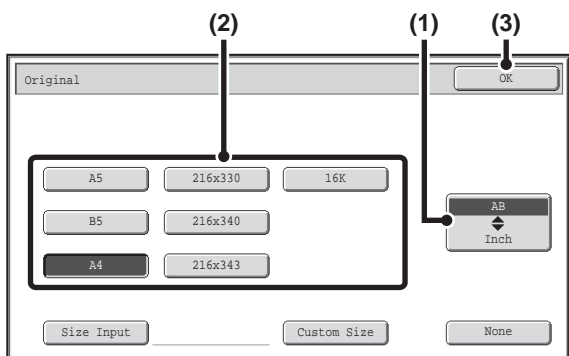

- (1) Touch the [AB  $\blacklozenge$  Inch] key.
- (2) Touch the appropriate original size key.
- (3) Touch the [OK] key.

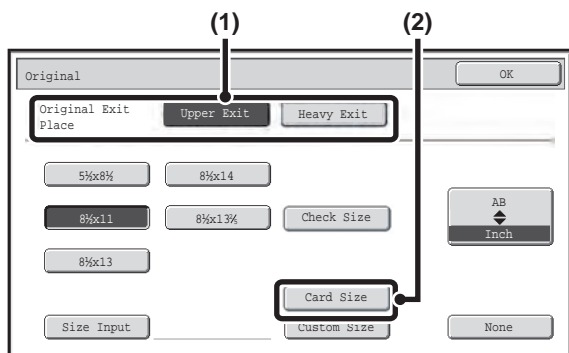

With the MX-B402SC, touch the [Original] key to display the screen at left.

- (1) The original output destination for the automatic document feeder can be selected.
- (2) When a card size original is set in the automatic document feeder, the card size can be selected.



- **System Settings (Administrator): Default original size setting**

Set this if you frequently use a particular original size. The set size will appear in the [Original] key. When this setting is configured, changing the original size can be omitted.

- **System settings (Administrator): Setting of Default Original Exit Place (MX-B402SC Only)**

When the automatic document feeder is used, the original's default output destination can be set to the upper exit or the heavy exit. (Except when "Size Input" or "Card Size" is selected for the original size.)



- **MX-B402SC Only**

- In the situations below, the original exit place is fixed to the heavy exit.
  - When "Card Size" is selected
  - When the original guide is set to 2 7/8" (74 mm) or lower (Except when "Check Size" is selected)
  - When the automatic document feeder is scanning an original with an X (horizontal) value of 4 1/8" (105 mm) or less
- When "Card Size" is selected, you cannot copy if the original guide is set to 2 7/8" (74 mm) or higher.

## Specifying a non-standard original size

1

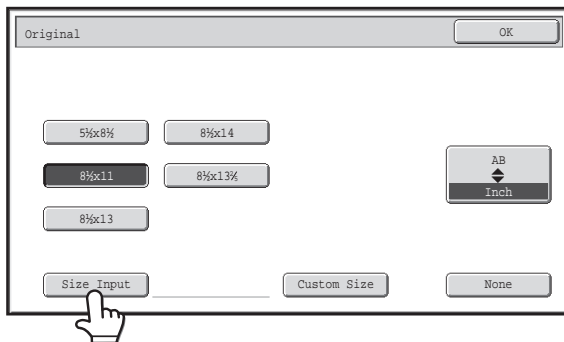

Touch the [Size Input] key.



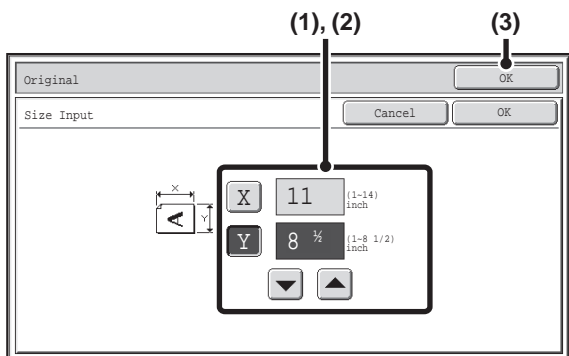

**Enter the original size.**

**(1) Enter the X (horizontal) dimension of the original.**

With the [X] key highlighted, enter the X (horizontal) dimension of the original with the keys. When the document glass is used, enter a number from 1" to 11-5/8" (25 mm to 297 mm).

**MX-B402:**

When the automatic document feeder is used, enter a number from 3-1/2" to 14" (89 mm to 356 mm). When a number which is from 5-3/8" (139 mm) and less is entered in 2-Sided copy mode, an original cannot be scanned.

If the horizontal dimension of the original is less than 3-1/2" (89 mm), use the document glass.

**MX-B402SC:**

When the automatic document feeder is used, enter a number from 3-1/4" to 14" (85 mm to 356 mm). When a number which is from 3-1/8" (84 mm) and less is entered in 2-Sided copy mode, an original cannot be scanned.

If the horizontal dimension of the original is less than 3-1/4" (85 mm), use the document glass.

**(2) Enter the Y (vertical) dimension of the original.**

Touch the [Y] key and enter the Y (vertical) dimension of the original with the keys. When the document glass is used, enter a number from 1" to 8-1/2" (25 mm to 216 mm).

**MX-B402:**

When the automatic document feeder is used, enter a number from 4" to 8-1/2" (100 mm to 216 mm). If the vertical dimension of the original is less than 4" (100 mm), use the document glass.

**MX-B402SC:**

When the automatic document feeder is used, enter a number from 2" to 8-1/2" (51 mm to 216 mm). If the vertical dimension of the original is less than 2" (51 mm), use the document glass.

**(3) Touch the [OK] key.**

You will return to the base screen. Make sure that the entered dimensions appear in the [Original] key.



**MX-B402:**

- When a number from 11-3/4" to 14" (298 mm to 356 mm) to the X (horizontal) dimension and a number from 1" to 3-7/8" (25 mm to 99 mm) to the Y (vertical) dimension are entered at the same time, an original cannot be scanned.

**MX-B402SC:**

- When a number from 11-3/4" to 14" (298 mm to 356 mm) to the X (horizontal) dimension and a number from 1" to 1-7/8" (25 mm to 50 mm) to the Y (vertical) dimension are entered at the same time, an original cannot be scanned.
- When the X (horizontal) value is set to 4 1/8" (105 mm) or lower and the Y (vertical) value is set to 2 7/8" (74 mm) or lower, "Card Size" is automatically selected and the original exit place is fixed to the heavy exit.

# STORING FREQUENTLY USED ORIGINAL SIZES

You can save special original sizes that you frequently use. This section explains how to store, retrieve, change, and delete special original sizes.

## Storing original sizes (editing/clearing)

Up to 12 special original sizes can be stored.

Touch the [Original] key in the base screen of copy mode and then follow the steps below.

1

**Touch the [Custom Size] key.**

2

**Store the original size.**

(1) Touch the [Store/Delete] tab.

(2) Touch a key for storing a custom original size.

Touch a key that does not show a size ( ).



**If you wish to edit or clear a previously stored key...**

Touch the key that you want to edit or clear. The following screen will appear.



- To edit the key, touch the [Modify] key and go to the next step.
- To clear the key, touch the [Delete] key. Make sure that the original size has been cleared and touch the [OK] key.

3

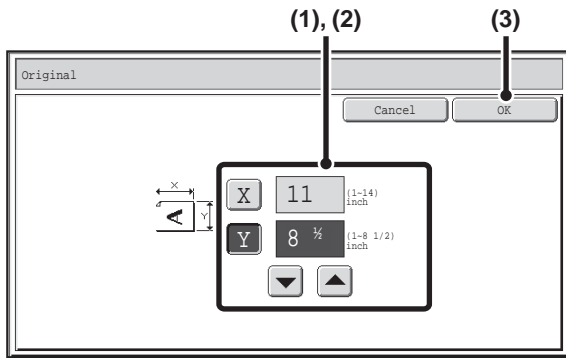

### Enter the original size.

**(1) Enter the X (horizontal) dimension of the original.**

With the [X] key highlighted, enter the X (horizontal) dimension of the original with the keys. A dimension from 1" to 14" (25 mm to 356 mm) can be entered.

**(2) Enter the Y (vertical) dimension of the original.**

Touch the [Y] key and enter the Y (vertical) dimension of the original with the keys. A dimension from 1" to 8-1/2" (25 mm to 216 mm) can be entered.

**(3) Touch the [OK] key.**



The stored original size will be retained even if the main power is turned off.



**To cancel the operation...**

Press the [CLEAR ALL] key ().

## Retrieving a stored original size

To retrieve a stored original size, touch the [Original] key in the base screen of copy mode and perform the steps below.

1

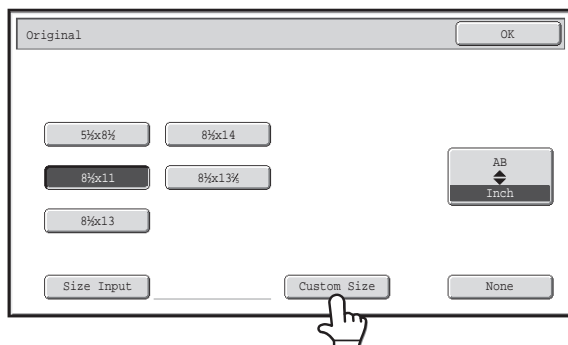

Touch the [Custom Size] key.

2

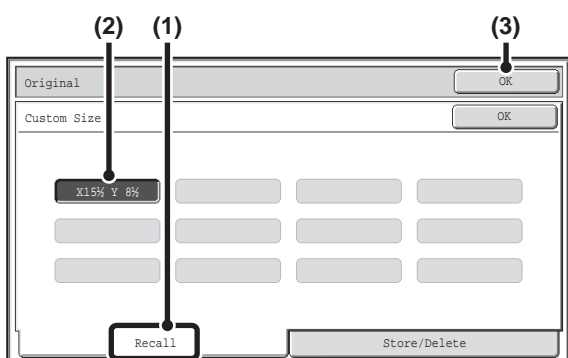

Retrieve the desired stored original size.

- (1) Touch the [Recall] tab.
- (2) Touch the key of the original size that you wish to retrieve.
- (3) Touch the [OK] key.



To cancel the operation...

Press the [CLEAR ALL] key (CA).

# OUTPUT

To select output functions and the output tray, touch the [Output] key in the base screen of copy mode. Output functions that can be selected are sort, group, offset, and staple sort. All explanations of the settings below assume that a finisher is installed.

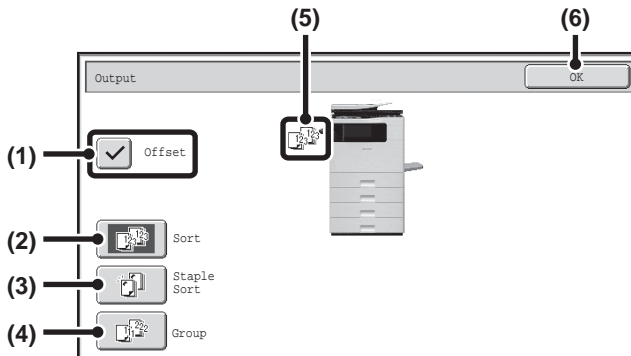

**(1) [Offset] key**

This is used to offset each set of output from the previous set.

The offset function operates when the checkbox is selected  and does not operate when the checkbox is not selected . (The offset checkmark is automatically cleared when the staple sort function is selected.)

[Offset function](#) (page 2-36)

**(2) [Sort] key**

This is used to sort (collate) output into sets.

[Sort mode](#) (page 2-36)

**(3) [Staple Sort] key**

This is used to sort output into sets, staple each set, and deliver the sets to the tray. (Note that the sets will not be offset in the output tray.)

[Staple sort function](#) (page 2-37)

**(4) [Group] key**

This is used to group copies by page.

[Group mode](#) (page 2-36)

**(5) Output display**

An icon will appear to indicate the output mode.

**(6) [OK] key**

Touch this key to close the output screen and return to the base screen.

 The above screen shows the keys that appear when a finisher is installed. The keys that appear will vary depending on what peripheral devices are installed. In addition, it may not be possible to select some keys depending what peripheral devices are installed. If different from the above screen, refer to the screen below.

**Example**

The screen when a finisher is not installed.



# OUTPUT MODES

This section explains the output modes.

## Sort mode

This is used to sort (collate) output into sets.

**Example: Sorting the output into 5 sets**

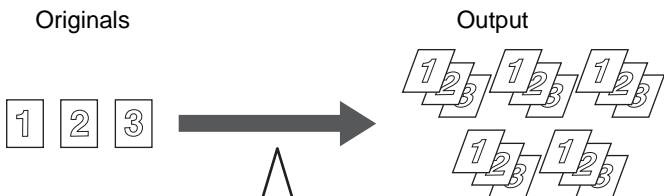



Set the number of copies (5).

↓



Touch the [Output] key.

↓



Touch the [Sort] key.

↓

Press the [START] key.

-  The sort function is automatically selected when originals are placed in the automatic document feeder.
- When the Quick File Folder for document filing is full, copying of a large number of originals using the sort function will be impeded. Delete unneeded files from the Quick File Folder.

## Group mode

This function groups copies by page.

**Example: Groups of 5 copies of each page**

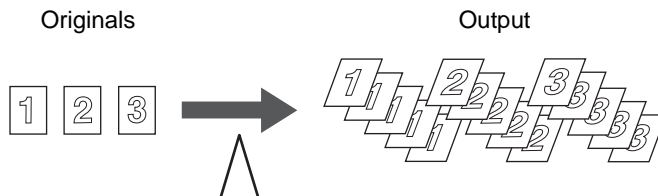



Set the number of copies (5).

↓

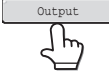

Touch the [Output] key.

↓



Touch the [Group] key.

↓

Press the [START] key.

-  The group function is automatically selected when an original is placed on the document glass.

## Offset function

This function offsets each set of copies from the previous set in the output tray, making it easy to separate sets of copies.

Offset function "ON"

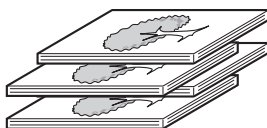

Offset function "OFF"

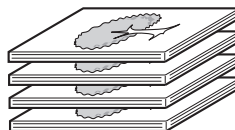

-  In the following cases, the offset function cannot be selected:
  - When 5-1/2" x 8-1/2" (A5) size paper is selected.
  - When the staple sort function is selected.

## Staple sort function

The staple sort function sorts output into sets, staples each set, and delivers the sets to the tray.

The relations between the stapling positions, paper orientation, permitted paper sizes for stapling, and number of sheets that can be stapled are shown below.

For original placement orientations, see "[Original placement orientation](#)" (page 2-37).

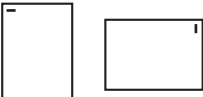

Staple sort

Stapling positions	Paper
	<p><b>Applicable paper sizes</b>                      8-1/2" x 14", 8-1/2" x 13-1/2", 8-1/2" x 13-2/5", 8-1/2" x 13", 8-1/2" x 11", 7-1/4" x 10-1/2", A4, B5, 16K</p> <p><b>Number of sheets that can be stapled</b>                      Max. 30 sheets</p>

## Original placement orientation

When using the staple sort function, the original must be placed as shown below to enable stapling in the desired position on the paper.

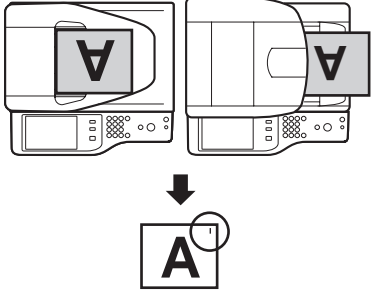
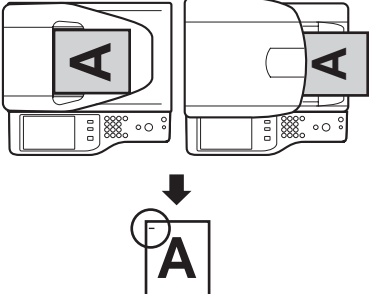
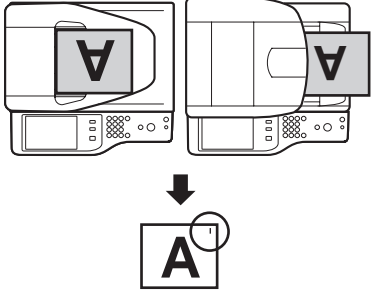
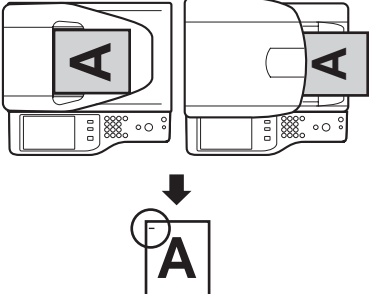
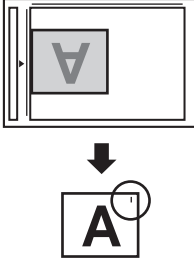
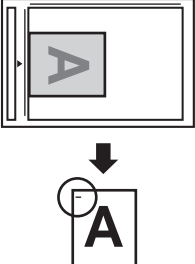
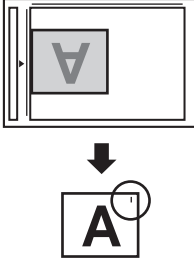
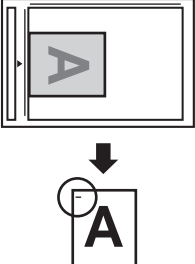
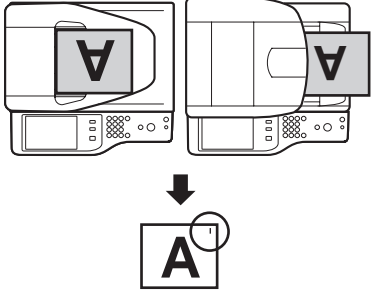
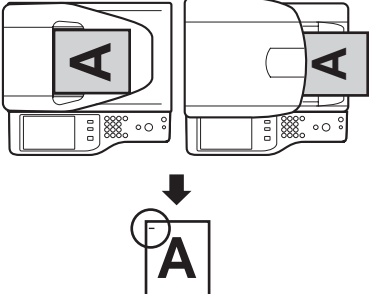
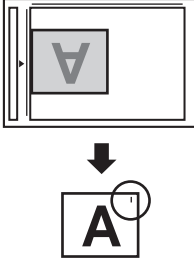
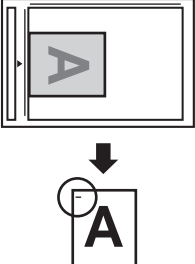
Document feeder tray	Document glass				
<table border="0" style="width: 100%;"> <tr> <td style="text-align: center; width: 50%;"> <p><b>MX-B402</b>      <b>MX-B402SC</b></p>  </td> <td style="text-align: center; width: 50%;"> <p><b>MX-B402</b>      <b>MX-B402SC</b></p>  </td> </tr> </table>	<p><b>MX-B402</b>      <b>MX-B402SC</b></p> 	<p><b>MX-B402</b>      <b>MX-B402SC</b></p> 	<table border="0" style="width: 100%;"> <tr> <td style="text-align: center; width: 50%;">  </td> <td style="text-align: center; width: 50%;">  </td> </tr> </table>		
<p><b>MX-B402</b>      <b>MX-B402SC</b></p> 	<p><b>MX-B402</b>      <b>MX-B402SC</b></p> 				
					

# MAKING COPIES USING THE BYPASS TRAY

In addition to plain paper, the bypass tray allows you to make copies on transparency film, envelopes, and other special media.

For detailed information on paper that can be loaded in the bypass tray, see "[IMPORTANT POINTS ABOUT PAPER](#)" (page 1-27) in "1. BEFORE USING THE MACHINE". For precautions when loading paper in the bypass tray, see "[LOADING PAPER IN THE BYPASS TRAY](#)" (page 1-33) in "1. BEFORE USING THE MACHINE".

## Place the original.

Place the original face up in the document feeder tray, or face down on the document glass.

Place the original in the automatic document feeder.

[PLACING ORIGINALS IN THE AUTOMATIC DOCUMENT FEEDER](#) (page 1-37)

**1** After placing the original, specify the original size.

[ORIGINAL SIZES](#) (page 2-29)

### When placing the originals on the document glass...

After placing the original, be sure to close the automatic document feeder. If left open, parts outside of the original will be copied black, causing excessive use of toner.

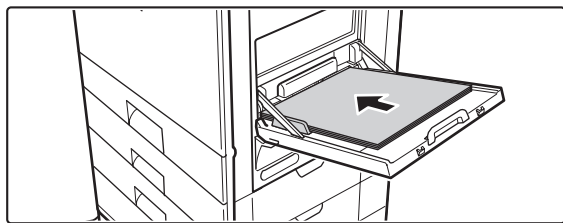

## Place paper in the bypass tray.

Insert the paper with print side face down.

**2**

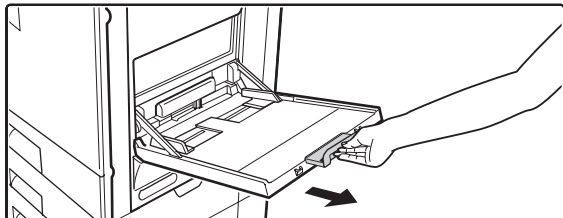

When loading paper larger than 8-1/2" x 11" or A4, be sure to pull out the bypass tray extension. Pull the bypass tray extension all the way out. If the bypass tray extension is not pulled all the way out, the size of the loaded paper will not be correctly displayed.

**3**

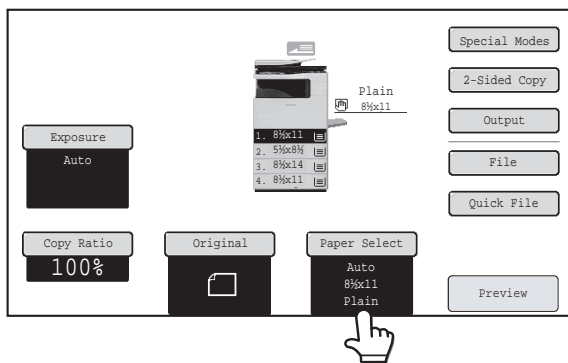

## Touch the [Paper Select] key.



4

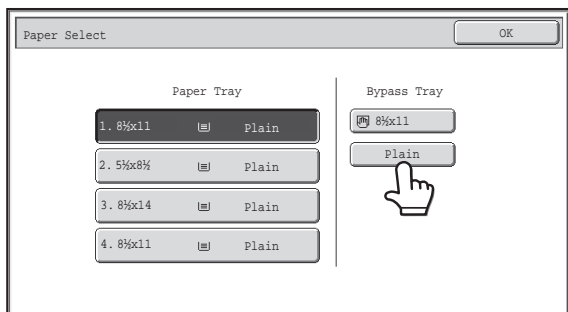

**Check the paper type setting for the bypass tray. If you need to change the setting, touch the paper type key.**

If you do not need to change the paper size and type that appear under "Bypass Tray", go to step 7.

5

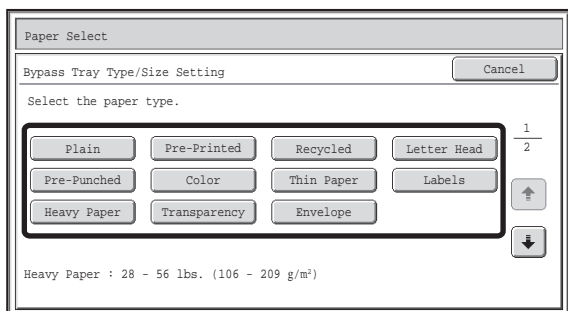

**Select the type of paper used in the bypass tray.**

Select the paper type that you will use.

6

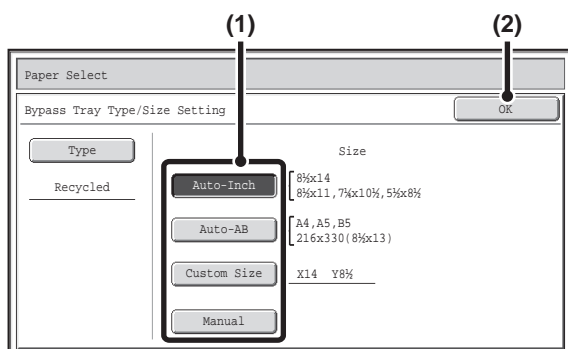

**Set the paper size.**

**(1) Select the paper size.**

**[Auto-Inch] key**

When the paper placed in the bypass tray is an inch size (8-1/2" x 11", etc.), the paper size will be detected automatically and an appropriate size set.

**[Auto-AB] key**

When the paper inserted in the bypass tray is an AB size (A4, etc.), the paper size will be detected automatically and an appropriate size set.

**[Custom Size] key**

Touch this key if you wish to enter numeric values for the size of the loaded paper.

[Enter the paper size of the bypass tray](#) (page 2-40)

**[Manual] key**

This key can be touched to display the [16K] key. Touch one of these keys if you loaded the corresponding size of paper.

**(2) Touch the [OK] key.**



When [Envelope] is selected, specify the size of the envelope. When finished, touch the [OK] key.

7

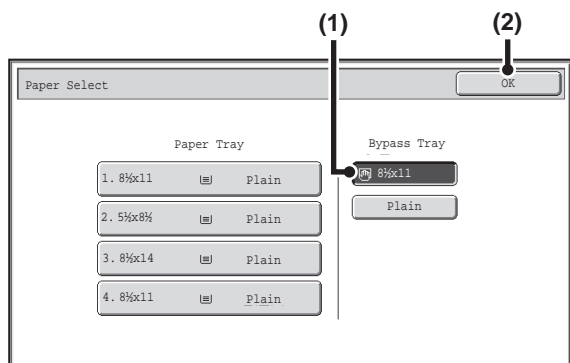

**Select the bypass tray.**



- (1) Touch the paper size key of the bypass tray.
- (2) Touch the [OK] key.

8

**Press the [START] key.**

Scanning begins.



- If the originals were placed in the document feeder tray, the originals are copied.
  - If you placed the originals on the document glass, scan each page one page at a time.
- When using sort mode, change originals and press the [START] key. Repeat until all pages have been scanned and then press the [Read-End] key.

 **To cancel scanning of the original and copying...**  
Press the [STOP] key (.

**Enter the paper size of the bypass tray**

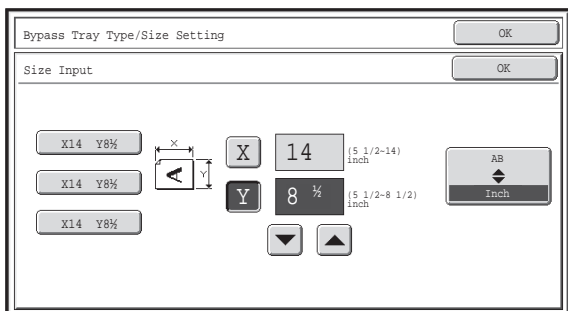
When the [Custom Size] key is touched, the paper size entry screen appears.



Touch the [X] key and enter the horizontal dimension of the paper with the   keys, and then touch the [Y] key and enter the vertical dimension. When finished, touch the [OK] key.

 Stored custom paper sizes appear in the keys on the left side of the screen. Custom paper sizes are stored in the system settings. For details, see "Paper Tray Settings" (page 7-14) in "7. SYSTEM SETTINGS". If the key for the size that you wish to enter appears, touch that key.

# SPECIAL MODES

This section explains Margin Shift, Erase, and other special modes.

## SPECIAL MODES

When the [Special Modes] key is pressed in the base screen, the special modes menu screen appears. The special modes menu consists of two screens. Touch the  $\downarrow$   $\uparrow$  keys to move between the screens. After selecting special mode settings, touch the [OK] key in the special modes menu screen to complete the settings and return to the base screen of copy mode.

### Special modes menu (1st screen)

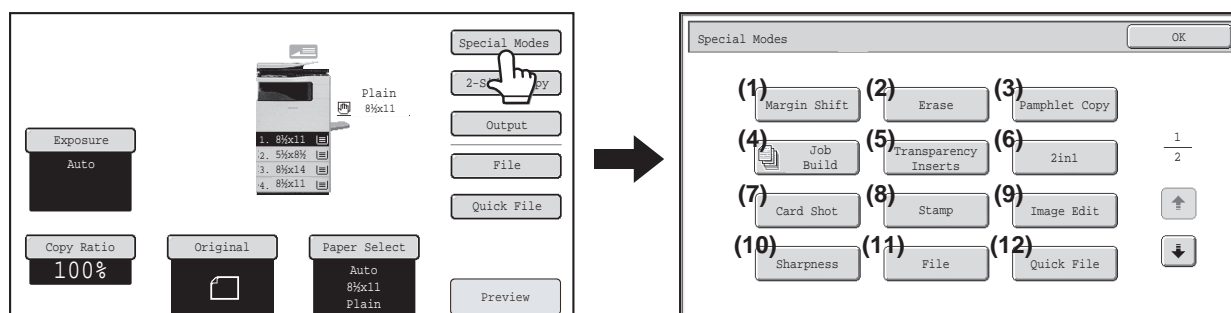

- |   |  |
|---|--|
| <p>(1) <b>[Margin Shift] key</b><br/> <math>\Rightarrow</math> <a href="#">ADDING MARGINS (Margin Shift)</a> (page 2-44)</p> <p>(2) <b>[Erase] key</b><br/> <math>\Rightarrow</math> <a href="#">ERASING PERIPHERAL SHADOWS (Erase)</a> (page 2-46)</p> <p>(3) <b>[Pamphlet Copy] key</b><br/> <math>\Rightarrow</math> <a href="#">MAKING COPIES IN PAMPHLET FORMAT (Pamphlet Copy)</a> (page 2-48)</p> <p>(4) <b>[Job Build] key</b><br/> <math>\Rightarrow</math> <a href="#">COPYING A LARGE NUMBER OF ORIGINALS AT ONCE (Job Build)</a> (page 2-51)</p> <p>(5) <b>[Transparency Inserts] key</b><br/> <math>\Rightarrow</math> <a href="#">ADDING INSERTS WHEN COPYING ON TRANSPARENCY FILM (Transparency Inserts)</a> (page 2-53)</p> <p>(6) <b>[2in1] key</b><br/> <math>\Rightarrow</math> <a href="#">COPYING TWO ORIGINAL PAGES ONTO ONE SHEET (2in1)</a> (page 2-55)</p> | <p>(7) <b>[Card Shot] key</b><br/> <math>\Rightarrow</math> <a href="#">COPYING BOTH SIDES OF A CARD ON ONE SHEET OF PAPER (Card Shot)</a> (page 2-57)</p> <p>(8) <b>[Stamp] key</b><br/> <math>\Rightarrow</math> <a href="#">PRINTING THE DATE AND A STAMP ON COPIES (Stamp)</a> (page 2-60)</p> <p>(9) <b>[Image Edit] key</b><br/> <math>\Rightarrow</math> <a href="#">[Image Edit] KEY</a> (page 2-77)</p> <p>(10) <b>[Sharpness] key</b><br/> <math>\Rightarrow</math> <a href="#">ADJUSTING THE SHARPNESS OF AN IMAGE (Sharpness)</a> (page 2-85)</p> <p>(11) <b>[File] key</b><br/>           This saves a job in a folder of the document filing function.</p> <p>(12) <b>[Quick File] key</b><br/>           This saves a job in the Quick File folder of the document filing function.</p> |
|---|--|

## Special modes menu (2nd screen)

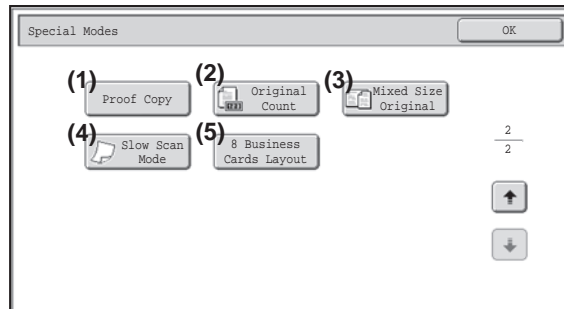

- (1) **[Proof Copy] key**  
 ⓘ CHECKING COPIES BEFORE PRINTING (Proof Copy) (page 2-87)
- (2) **[Original Count] key**  
 ⓘ CHECKING THE NUMBER OF SCANNED ORIGINAL SHEETS BEFORE COPYING (Original Count) (page 2-90)
- (3) **[Mixed Size Original] key**  
 ⓘ COPYING ORIGINALS OF DIFFERENT SIZES (Mixed Size Original) (page 2-91)
- (4) **[Slow Scan Mode] key**  
 ⓘ COPYING THIN ORIGINALS (Slow Scan Mode) (page 2-94)
- (5) **[8 Business Cards Layout] key\***  
 ⓘ COPYING MULTIPLE BUSINESS CARDS (8 Business Cards Layout) (page 2-96)

\* To use this function on MX-B402, the business card feeder must be attached to the automatic document feeder and "Business Card Scan Option" must be enabled in the system settings (administrator). For the attachment procedure, see "BUSINESS CARD FEEDER" in "1. BEFORE USING THE MACHINE" (page 1-47).

 Special modes can generally be combined with other special modes, however, there are some combinations that are not possible. In this case, a message indicating that the combination is not possible will be displayed.

## [OK] key and [Cancel] key

In some cases two [OK] keys and one [Cancel] key will appear in the special mode screens. The keys are used as follows:

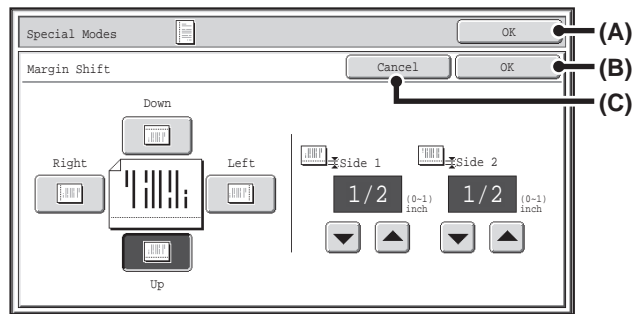

- (A) Enter the selected special mode settings and return to the base screen of copy mode.
- (B) Enter the selected special mode settings and return to the special modes menu screen. Touch this key when you wish to continue selecting other special mode settings.
- (C) During selection of special mode settings, this key returns you to the special modes menu screen without saving the settings. When settings have been completed, this cancels the settings and returns you to the special modes menu screen.

# ADDING MARGINS (Margin Shift)

This function is used to shift the copy image right, left, up or down to adjust the margin. This is convenient when you wish to hole punch the copies.

**Shifting the image to the right so the copies can be bound at the left edge with a string**

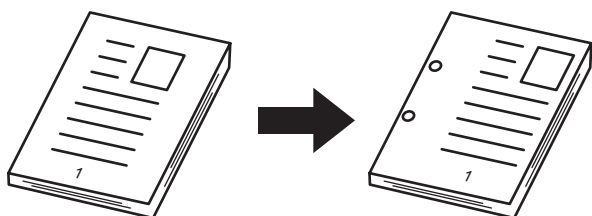

Not using margin shift	Using margin shift
<p>The punch holes cut off part of the image</p>	<p>The image is moved to allow space for the holes so the image is not cut off.</p>

## 1 Place the original.

- Place the original face up in the document feeder tray, or face down on the document glass.
- Place the original in the automatic document feeder.
  - ▶ [PLACING ORIGINALS IN THE AUTOMATIC DOCUMENT FEEDER](#) (page 1-37)
- After placing the original, specify the original size.
  - ▶ [ORIGINAL SIZES](#) (page 2-29)

## 2 Select the special modes.

- Touch the [Special Modes] key.
- Touch the [Margin Shift] key.
  - ▶ [Special modes menu \(1st screen\)](#) (page 2-41)

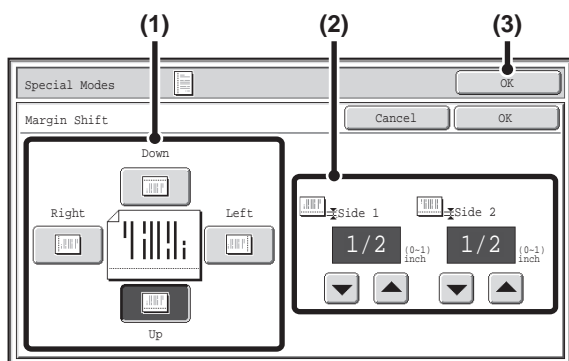

## 3 Set the margin shift.

- Touch the margin shift position.
  - Select one of the 4 positions.
- Set the amount of the margin shift with .
  - 0" to 1" (0 mm to 20 mm) can be entered.
- Touch the [OK] key.
  - You will return to the base screen of copy mode.

4

**Press the [START] key.**

Copying will begin.

If you are using the document glass to copy multiple original pages, copying will take place as you scan each original. If you have selected sort mode, change originals and press the [START] key. Repeat until all pages have been scanned and then touch the [Read-End] key.

**To cancel scanning of the original and copying...**

Press the [STOP] key (⏹).



Rotation copy cannot be used in combination with margin shift.

**To cancel the margin shift setting...**

Touch the [Cancel] key in the screen of step 3.

**System Settings (Administrator): Initial Margin Shift Setting**

The default margin shift setting can be set from 0" to 1" (0 mm to 20 mm). The factory default setting is 1/2" (10 mm).

# ERASING PERIPHERAL SHADOWS (Erase)

The erase function is used to erase shadows around the edges of copies that occur when copying thick originals or books.

## When a thick book is copied

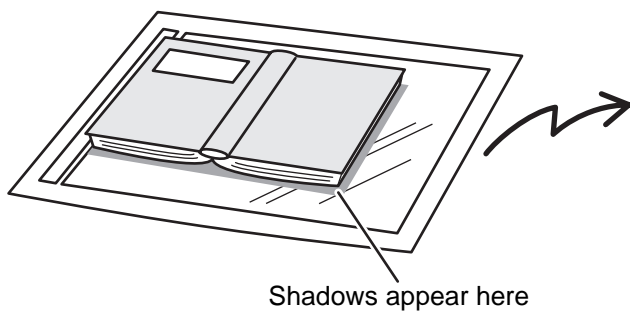

Not using the erase function	Using the erase function
<p>Shadows appear on the copy.</p>	<p>Shadows do not appear on the copy.</p>

## Erase modes



### 1 Place the original.

Place the original face up in the document feeder tray, or face down on the document glass.

Place the original in the automatic document feeder.

☞ [PLACING ORIGINALS IN THE AUTOMATIC DOCUMENT FEEDER](#) (page 1-37)

After placing the original, specify the original size.

☞ [ORIGINAL SIZES](#) (page 2-29)

### 2 Select the special modes.

(1) Touch the [Special Modes] key.

(2) Touch the [Erase] key.

☞ [Special modes menu \(1st screen\)](#) (page 2-41)



3

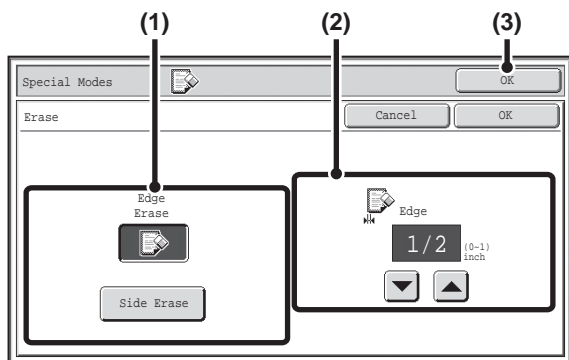

Select the erase settings.

(1) Touch the desired erase mode.

Select one of the 2 positions.

Touch the [Side Erase] key to open the following screen.

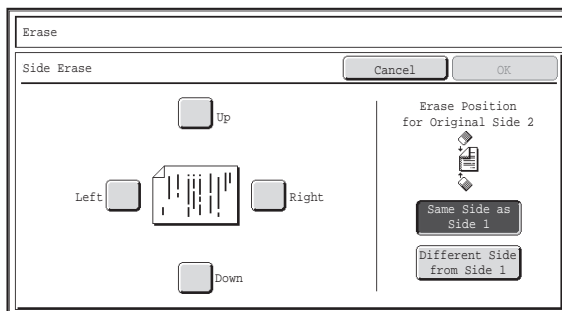

Touch the checkbox of the edge that you wish to erase and make sure that a checkmark appears.

When performing 1-sided to 2-sided copying or 2-sided to 2-sided copying, set the erase edge on the reverse side.

- If you touch the [Same Side as Side 1] key, the edge in the same position as on the front side will be erased.
- If you touch the [Different Side from Side 1], the edge in the position opposite to the erased edge on the front side will be erased.

When you have completed the erase edge settings, touch the [OK] key.

(2) Set the erasure width with .

0" to 1" (0 mm to 20 mm) can be entered.

(3) Touch the [OK] key.

You will return to the base screen of copy mode.

4

Press the [START] key.

Copying will begin.

If you are using the document glass to copy multiple original pages, copying will take place as you scan each original. If you have selected sort mode, change originals and press the [START] key. Repeat until all pages have been scanned and then touch the [Read-End] key.

To cancel scanning of the original and copying...

Press the [STOP] key ().

If a ratio setting is used in combination with an erase setting, the erase width will change according to the selected ratio. For example, if the erase width setting is 1" (20 mm) and the image is reduced to 50%, the erase width will be 1/2" (10 mm).

To cancel the erase setting...  
Touch the [Cancel] key in the screen of step 3.

System Settings (Administrator): Erase Width Adjustment  
The default erase width can be set from 0" to 1" (0 mm to 20 mm). The factory default setting is 1/2" (10 mm).

# MAKING COPIES IN PAMPHLET FORMAT (Pamphlet Copy)

This function copies 2 original pages onto the front side and 2 original pages onto the reverse side of each sheet of paper so that the copies can be folded at the centerline to form a pamphlet.

This function is convenient for arranging copies into an attractive booklet or pamphlet.

## Pamphlet copy using 8 original pages

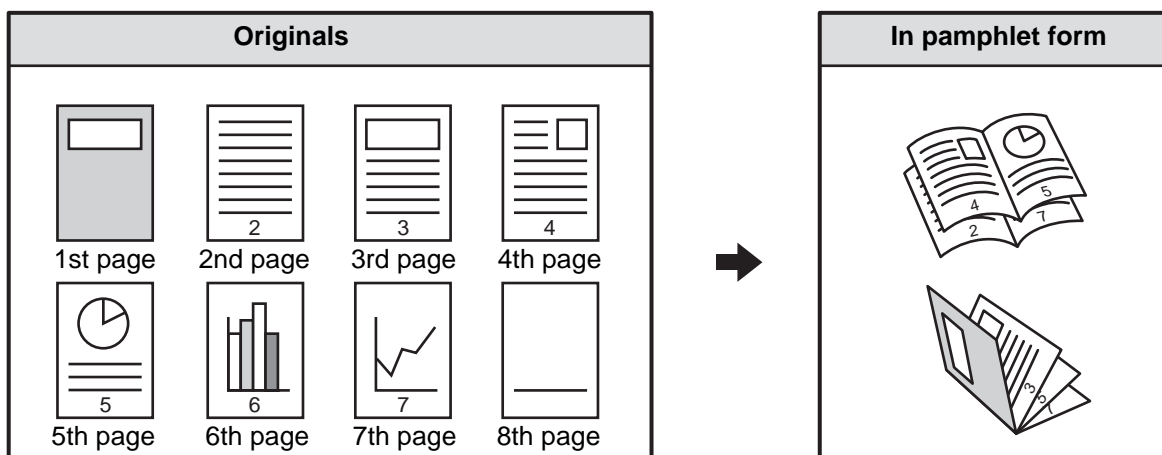

## Binding side

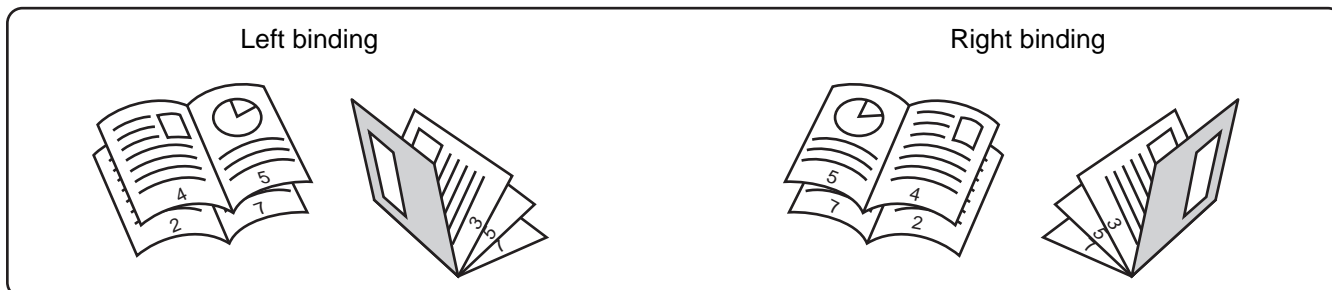

## Place the original.

Place the original face up in the document feeder tray, or face down on the document glass.

When using this function with a portrait original on the document glass, place the original so that the top of the image is to the right.

1

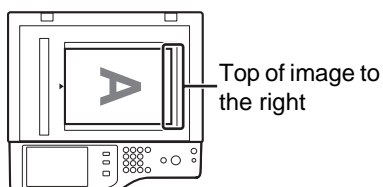

Place the original in the automatic document feeder.

➤ [PLACING ORIGINALS IN THE AUTOMATIC DOCUMENT FEEDER](#) (page 1-37)

After placing the original, specify the original size.

➤ [ORIGINAL SIZES](#) (page 2-29)



If the originals are 2-sided, place them in the document feeder tray.

**Select the special modes.**

2

(1) Touch the [Special Modes] key.

(2) Touch the [Pamphlet Copy] key.

[Special modes menu \(1st screen\)](#) (page 2-41)

3

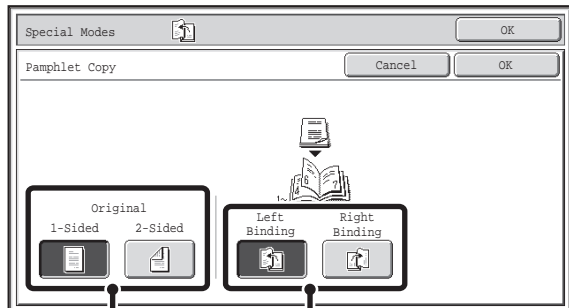

(1)

(2)

**Select pamphlet copy settings.**

(1) If the original is 1-sided, touch the [1-Sided] key. If the original is 2-sided, touch the [2-Sided] key.

(2) Select the binding edge ([Left Binding] or [Right Binding]).

4

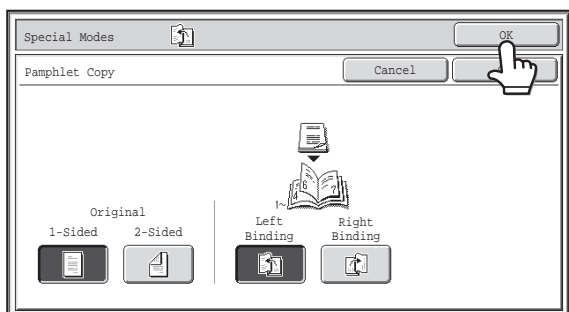

**Touch the [OK] key.**

You will return to the base screen of copy mode.

**Press the [START] key.**

Copying will begin.

If you are using the document glass, change originals and press the [START] key. Repeat until all pages have been scanned and then touch the [Read-End] key.

5

**To cancel scanning of the original and copying...**

Press the [STOP] key ().



- When the pamphlet copy function is selected, copying in group mode and staple sort mode is not possible.
- When the pamphlet copy function is selected, 2-sided copying mode is automatically selected. When settings are selected that prevent 2-sided copying, the pamphlet copy function cannot be used.
- Scan the originals in order from the first page to the last page. The order of copying will be automatically adjusted by the machine. Four original pages will be copied onto each sheet of paper. Blank pages will be automatically produced at the end if the number of original pages is not a multiple of four.
- **To make landscape originals into a pamphlet with a tablet binding ...**  
Place the originals in the indicated orientation and select [Right Binding] in (2) of step 3.

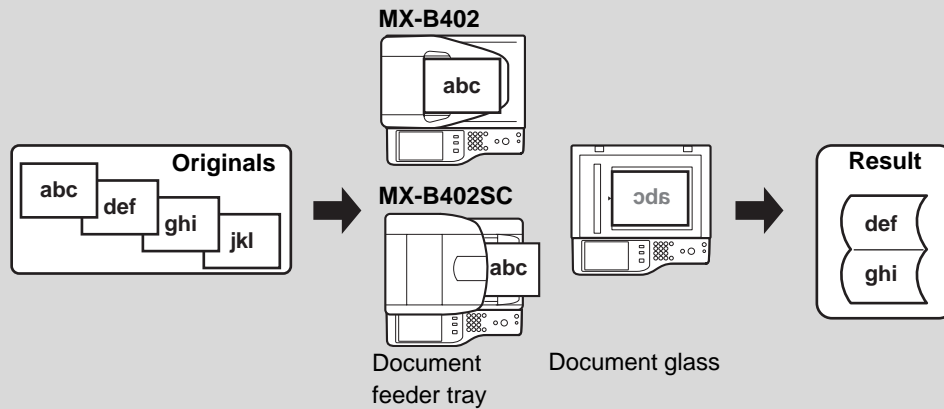

#### To cancel pamphlet copy...

Touch the [Cancel] key in the screen of step 3.

# COPYING A LARGE NUMBER OF ORIGINALS AT ONCE (Job Build)

When copying a very large number of originals, this function allows you to divide the originals into sets and feed each set through the automatic document feeder one set at a time.

Use this function when you wish to copy all of the originals as a single job but the number of originals exceeds the maximum number that can be inserted.

This function is convenient when you wish to sort copies of a large number of originals into multiple sets. Because all originals are copied as a single job, you are saved the trouble of sorting the copies that would be required if the originals were divided into separate copy jobs.

When scanning originals in sets, divide the sheets so that no set has more than the number of paper that can be loaded, and then scan from the set with the first page. The settings that you select for the first set can be used for all remaining sets.

## Sorting the copies of a large number of originals into 2 sets

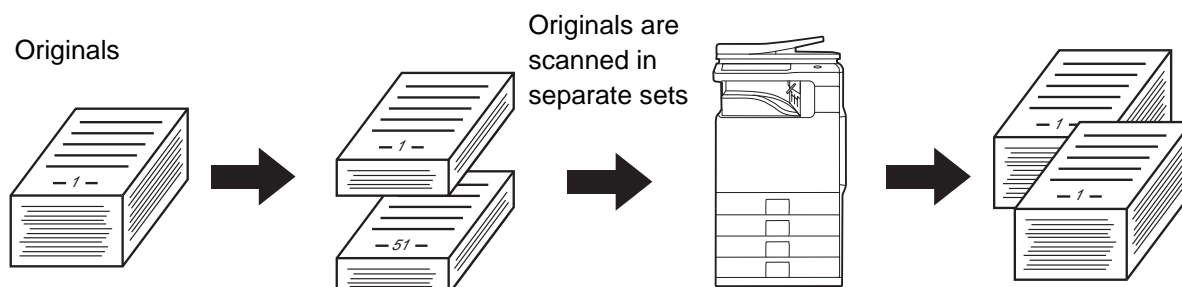

## 1 Insert the originals face up in the document feeder tray.

Place the original in the automatic document feeder.

☞ [PLACING ORIGINALS IN THE AUTOMATIC DOCUMENT FEEDER](#) (page 1-37)

After placing the original, specify the original size.

☞ [ORIGINAL SIZES](#) (page 2-29)

2

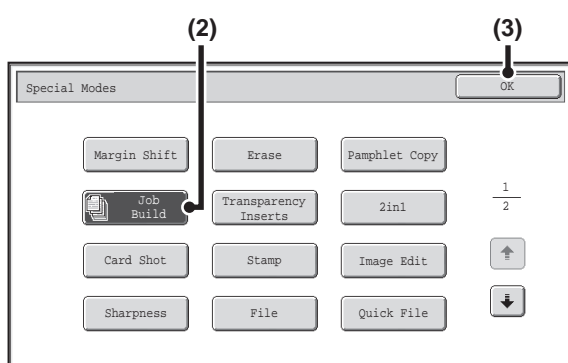

## Select the special modes.

(1) Touch the [Special Modes] key.

☞ [SPECIAL MODES](#) (page 2-41)

(2) Touch the [Job Build] key so that it is highlighted.

(3) Touch the [OK] key.

You will return to the base screen of copy mode.

## 3 Press the [START] key to scan the first set of originals.

Scanning begins.

3



To cancel scanning...

Press the [STOP] key (Ⓢ).

**4 Insert the next set of originals and press the [START] key.**

Repeat this step until all originals have been scanned.

**4****To cancel scanning...**

Press the [STOP] key (⏹). All scanned data will be cleared.

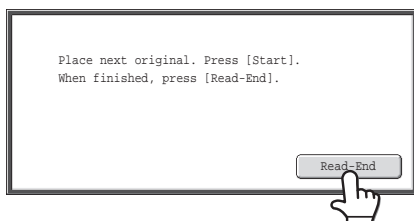
**5****Touch the [Read-End] key.****To cancel copying...**

Press the [STOP] key (⏹).



If the Quick File Folder of document filing mode is full, copying in job build mode will be impeded. Delete unneeded files from the Quick File Folder.

**To cancel job build mode....**

Touch the [Job Build] key in the screen of step 2 so that it is not highlighted.

# ADDING INSERTS WHEN COPYING ON TRANSPARENCY FILM

## (Transparency Inserts)

When copying on transparency film, the sheets may stick together due to static electricity. The transparency inserts function can be used to automatically insert a sheet of paper between each sheet of transparency film, making the sheets easy to handle.

It is also possible to copy on the inserts.

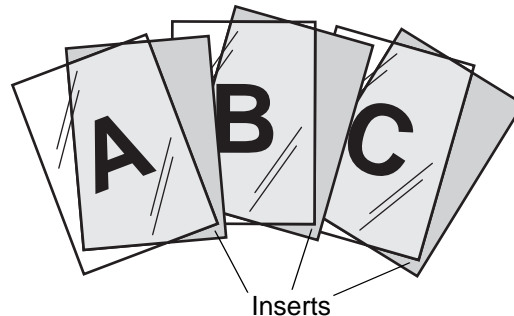

1

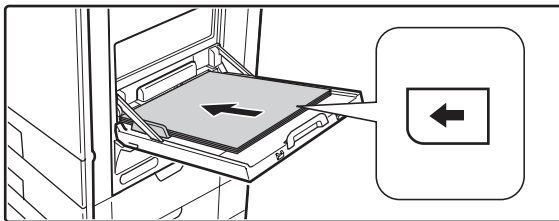

### Place the transparency film in the bypass tray.

- Transparency film can only be placed in the bypass tray.
- Place the transparency film face down on the bypass tray. When placing transparency film, place so that the rounded corner of the film is to the front and left.
- After loading the transparency film, configure the bypass tray settings as explained in "[MAKING COPIES USING THE BYPASS TRAY](#)" (page 2-38).

2

### Place the original.

Place the original face up in the document feeder tray, or face down on the document glass.

Place the original in the automatic document feeder.

☞ [PLACING ORIGINALS IN THE AUTOMATIC DOCUMENT FEEDER](#) (page 1-37)

After placing the original, specify the original size.

☞ [ORIGINAL SIZES](#) (page 2-29)

3

### Select the special modes.

(1) Touch the [Special Modes] key.

(2) Touch the [Transparency Inserts] key.

☞ [Special modes menu \(1st screen\)](#) (page 2-41)

4

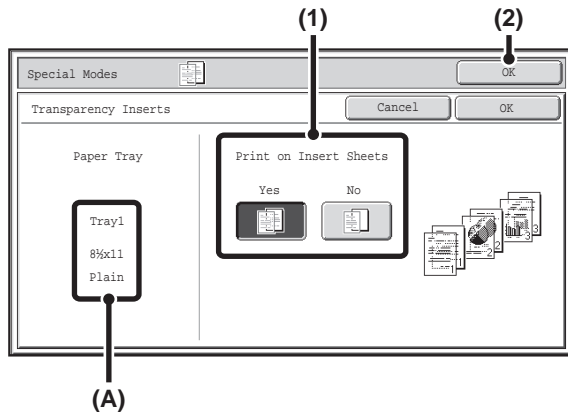

### Select insert settings.

(1) Select whether or not the insert paper will be copied on ([Yes] or [No]).

(2) Touch the [OK] key.

You will return to the base screen of copy mode.

#### Explanation of (A)

When transparency inserts is selected, paper suitable for the inserts is automatically selected. The automatically selected paper tray, paper size, and paper type are indicated here.

5

### Press the [START] key.

Copying will begin.



#### To cancel scanning and copying...

Press the [STOP] key (⏹).



- The number of copies cannot be selected in this mode.
- When performing 2-sided copying, only "2-sided to 1-sided" mode can be used.



#### To cancel the transparency inserts setting...

Touch the [Cancel] key in the screen of step 4.



# COPYING TWO ORIGINAL PAGES ONTO ONE SHEET (2in1)

Two original pages can be copied onto one sheet of paper. This function is convenient when you wish to present multiple pages in a compact format, or show a view of all pages in a document.

By copying two originals onto one sheet, the amount of paper used can be cut in half.

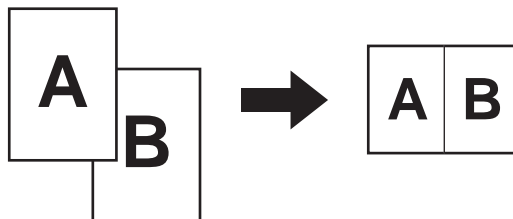

1

## Place the original.

Place the original face up in the document feeder tray, or face down on the document glass.

When using this function with a portrait original on the document glass, place the original so that the top of the image is to the right.

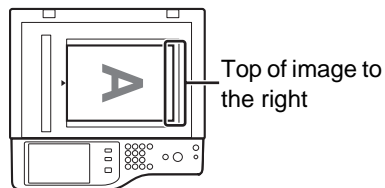

Place the original in the automatic document feeder.

➤ [PLACING ORIGINALS IN THE AUTOMATIC DOCUMENT FEEDER](#) (page 1-37)

After placing the original, specify the original size.

➤ [ORIGINAL SIZES](#) (page 2-29)

2

## Select the special modes.

(1) Touch the [Special Modes] key.

(2) Touch the [2in1] key.

➤ [Special modes menu \(1st screen\)](#) (page 2-41)

3

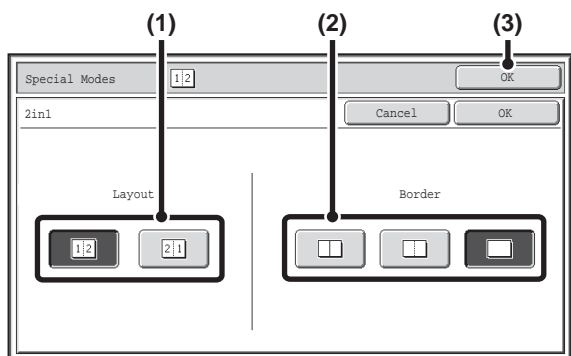

**Select the layout, and the border.**

**(1) Select the layout.**

Select the order in which the originals will be arranged on the copy.

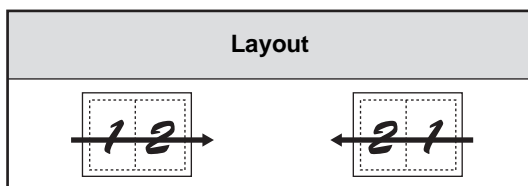

The arrows in the above diagram indicate how the images are arranged.

**(2) Select the border.**

Solid lines, broken lines, or no lines can be selected.

**(3) Touch the [OK] key.**

You will return to the base screen of copy mode.

4

**Press the [START] key.**

Copying will begin.

If you are using the document glass, change originals and press the [START] key. Repeat until all pages have been scanned and then touch the [Read-End] key.

**To cancel scanning and copying...**  
Press the [STOP] key (⏏).

**When using the 2in1 function, the appropriate copy ratio will be automatically set based on the original size, paper size, and the number of originals to be copied onto one sheet. The minimum possible reduction ratio is 50%. The original size, paper size, and selected number of original pages may require that the ratio be less than 50%. As copying will take place at 50% in this case, part of the original images may be cut off.**

**To cancel a 2in1 setting...**  
Touch the [Cancel] key in the screen of step 3.

# COPYING BOTH SIDES OF A CARD ON ONE SHEET OF PAPER (Card Shot)

When copying a card, this function allows you to copy the front and reverse sides together onto a single sheet of paper. This function is convenient for making copies for identification purposes and helps save paper.

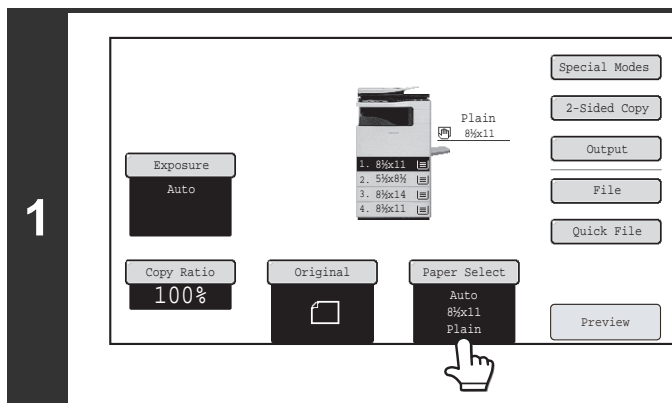
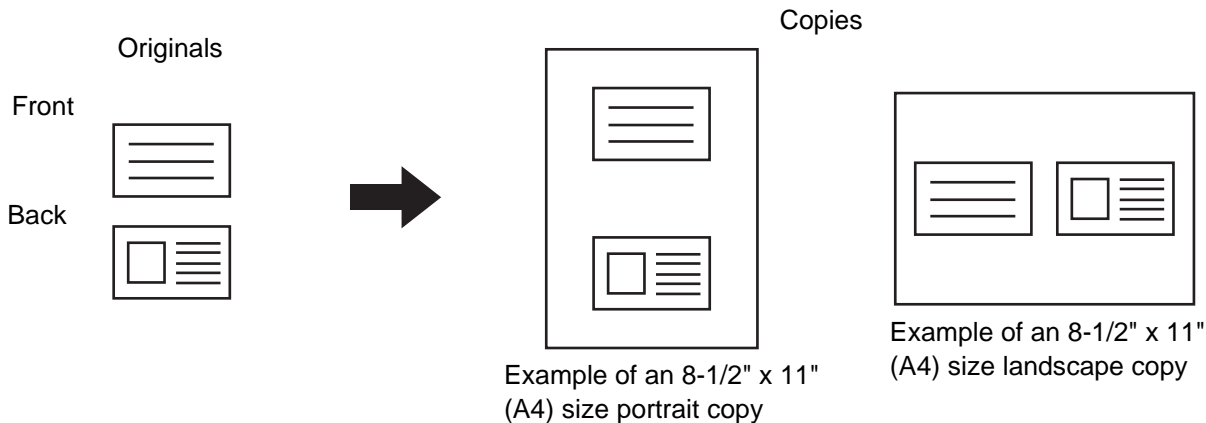

## Select the paper to be used for card shot.

Select the paper as explained in "PAPER TRAYS" (page 2-11).

## Place the original.

### MX-B402:

Place the original face down on the document glass.

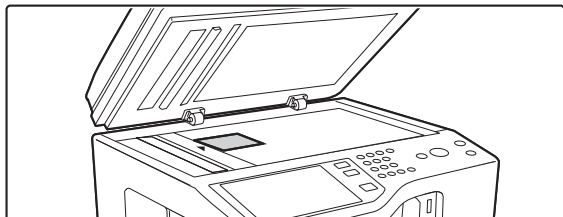

### MX-B402SC:

Place the original face up in the document feeder tray, or face down on the document glass.

➤ **PLACING ORIGINALS IN THE AUTOMATIC DOCUMENT FEEDER** (page 1-37)

- Set the original on the document glass → Set at the relative position in the right table.

Place the original as shown below when using the document feeder tray.

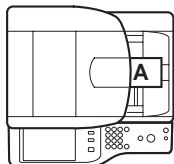

	Originals	Results
Front page		
Back page		
Front page		
Back page		

2

## Select the special modes.

(1) Touch the [Special Modes] key.

(2) Touch the [Card Shot] key.

➤ **Special modes menu (1st screen)** (page 2-41)

3

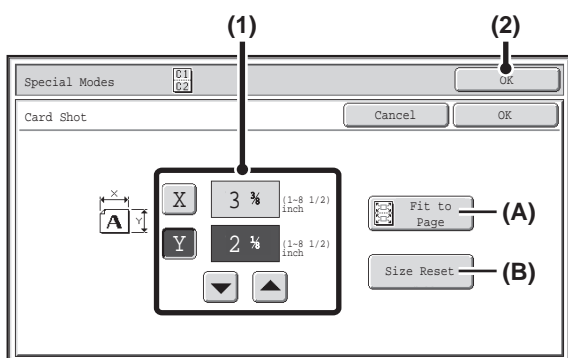

4

## Select card shot settings.

(1) Enter the original size.

With the [X] key highlighted, enter the X (horizontal) dimension of the original with the  $\downarrow$   $\uparrow$  keys. Touch the [Y] key and enter the Y (vertical) dimension of the original with the  $\downarrow$   $\uparrow$  keys.

- (A) To enlarge or reduce the images to fit the paper based on the entered original size, touch the [Fit to Page] key.
- (B) The [Size Reset] key can be pressed to return the horizontal and vertical dimensions to the values set in "Card Shot Settings" in the system settings (administrator).

(2) Touch the [OK] key.

You will return to the base screen of copy mode. Make sure that the entered dimensions appear in the [Original] key.

**5 Press the [START] key.**

---

**5**  **To cancel scanning...**  
Press the [STOP] key (⏹).

**When placing the original on the document glass, follow the procedure below.**

**6 Turn the card over and press the [START] key to scan the reverse side of the card.**

---

**6**  **To cancel scanning...**  
Press the [STOP] key (⏹).



**7**  **To cancel copying...**  
Press the [STOP] key (⏹).

Place next original. Press [Start].  
When finished, press [Read-End].



**Touch the [Read-End] key.**

Copying will begin.

-  • Copying is only possible on standard size paper.
-  • XY Zoom cannot be used when using this function.
-  • The image cannot be rotated when using this function.

**To cancel card shot...**  
Touch the [Cancel] key in the screen of step 4.

**System Settings (Administrator): Card Shot Settings**  
This is used to set the values to which the size returns when the [Size Reset] key is pressed. 1" to 8-1/2" (25 mm to 210 mm) can be entered for both the horizontal and vertical dimensions.  
The factory default settings are 3-3/8" (86 mm) for X (the width) and 2-1/8" (54 mm) for Y (the height).

# PRINTING THE DATE AND A STAMP ON COPIES (Stamp)

Use this function to print the date, a stamp, the page number, and text on copies.

Six printing positions are available: top left, top center, top right, bottom left, bottom center, and bottom right.

The printing positions are separated into areas that are used for the date, page number and text (A below), and areas that are used for a stamp (B below).

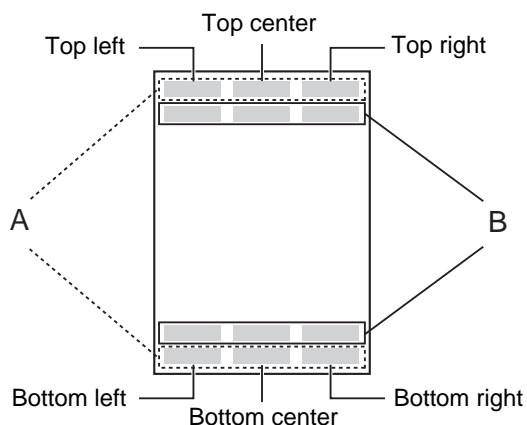

Stamp	Print area	Maximum number of positions
Date	A	1 position only
Stamp	B	6 positions
Page Numbering	A	1 position only
Text	A	6 positions



- If the selected stamp content of one position overlaps the stamp content of another position, priority will be given in the following order: right side, left side, center. Content that is hidden due to overlapping will not be printed.
- Text will be printed at the preset size regardless of the copy ratio or paper size setting.
- Text will be printed at the preset exposure regardless of the exposure setting.
- Depending on the size of the paper, some printed content may be cut off or shifted out of position.

## When used in combination with other special modes

When Stamp is used in combination with the following special modes, the special modes are reflected in the stamp content.

Special Modes	Printing
Margin Shift	Together with the image, the stamp content is shifted the amount of the margin width.
Centering	Unlike a copy image that moves, the image will be printed in the position set in the stamp.
Card Shot	The stamp is printed on each copy sheet.
2in1	The print content is printed on each original page.
Pamphlet Copy	The stamp is printed on each page of the resulting pamphlet.

# GENERAL PROCEDURE FOR USING STAMP

To select stamp settings, follow the steps below.

**1**

## Place the original.

Place the original face up in the document feeder tray, or face down on the document glass.

When using this function with a portrait original on the document glass, place the original so that the top of the image is to the right.

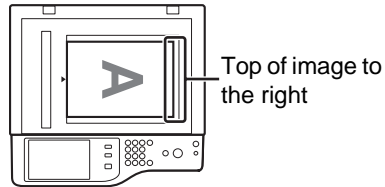

Place the original in the automatic document feeder.

➤ [PLACING ORIGINALS IN THE AUTOMATIC DOCUMENT FEEDER](#) (page 1-37)

After placing the original, specify the original size.

➤ [ORIGINAL SIZES](#) (page 2-29)

**2**

## Select the special modes.

(1) Touch the **[Special Modes]** key.

(2) Touch the **[Stamp]** key.

➤ [Special modes menu \(1st screen\)](#) (page 2-41)

3

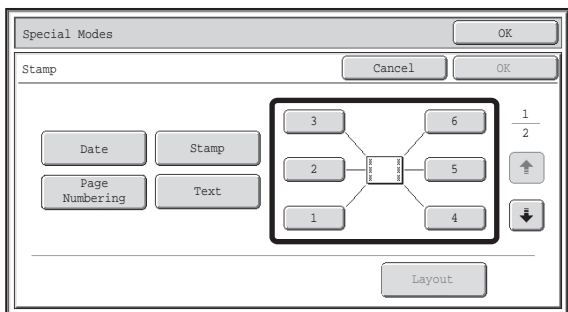

**Select the print position.**

Select from 6 positions: top left, top center, top right, bottom left, bottom center, bottom right.

You can also skip this step and go directly to the next step. In this case, the stamp items will be printed in the following positions:

**Date:** Top right                         **Stamp:** Top left  
**Page Numbering:** Bottom center   **Text:** Top left

**Print positions**

The keys that show the print positions will appear as follows depending on the state of the settings.

	Not selected, stamp setting has not been selected.
	Selected during selection of the stamp setting.
	Not available, stamp setting has already been selected.



- "Date" and "Page Numbering" cannot be selected in multiple positions. If the [Date] key or [Page Numbering] key is touched when "Date" or "Page Numbering" has already been selected for a position, a message will appear asking you if you wish to move that item to the selected position. To move the item, touch the [Yes] key. Otherwise, press the [No] key.
- If you attempt to set "Date", "Text", or "Page Numbering" in a position where one of these items is already set, a message will appear. To change the previously selected item to the new item, touch the [Yes] key. To keep the previous item, touch the [No] key.

4

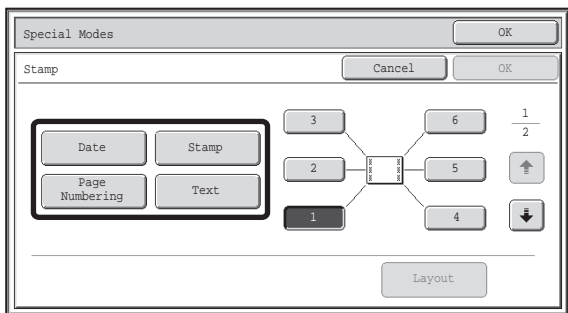

**Select Stamp.**

For detailed information on each of the stamp items, see the following sections:

- Date:** [ADDING THE DATE TO COPIES \(Date\)](#) (page 2-64)
- Stamp:** [STAMPING COPIES \(Stamp\)](#) (page 2-66)
- Page numbering:** [PRINTING PAGE NUMBERS ON COPIES \(Page Numbering\)](#) (page 2-68)
- Text:** [PRINTING TEXT ON COPIES \(Text\)](#) (page 2-71)

5

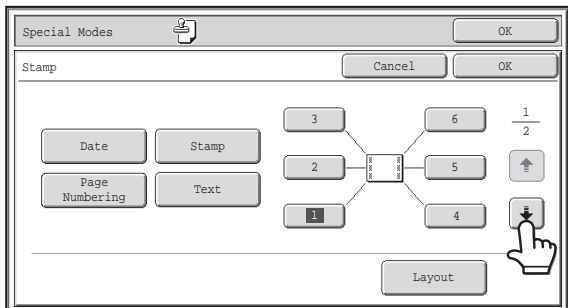

**When you have finished selecting stamp settings, touch the key.**



6

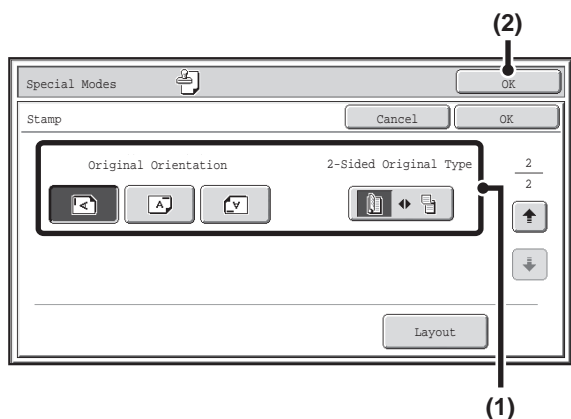

The [Original Orientation] key icon indicates the orientation of an original that has been placed in the automatic document feeder.

**Select settings for the original.**

**(1) Touch the [Original Orientation] key and specify the orientation of the placed original.**

If 2-sided originals have been placed, touch the  key and specify the binding position (booklet binding or tablet binding) of the originals.

**(2) Touch the [OK] key.**

You will return to the base screen of copy mode. To edit a stamp position or delete a stamp item, touch the [Layout] key.



 [CHECKING THE STAMP LAYOUT \(Layout\)](#) (page 2-75)

7

**Press the [START] key.**

Copying will begin.

If you are using the document glass to copy multiple original pages, copying will take place as you scan each original. If you have selected sort mode, change originals and press the [START] key. Repeat until all pages have been scanned and then touch the [Read-End] key.

 **To cancel scanning and copying...**  
Press the [STOP] key (.

 **To cancel Stamp...**  
Touch the [Cancel] key in the screen of step 3.

# ADDING THE DATE TO COPIES (Date)

The date can be printed on copies. The position of the date, format, and page (first page only or all pages) can be selected.

**Example: Printing APRIL 4, 2010 in the top right corner of the paper.**

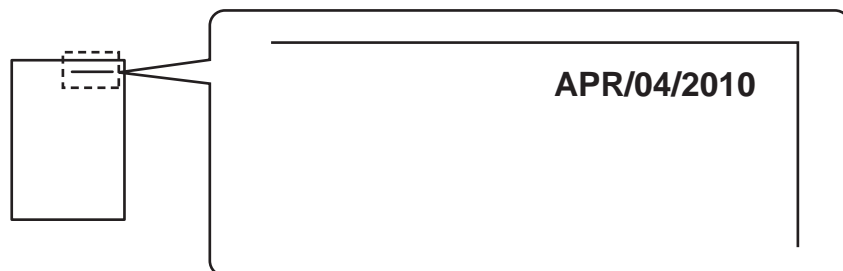

1

## Touch the [Date] key in the stamp selection screen.

See steps 1 to 4 of "GENERAL PROCEDURE FOR USING STAMP" (page 2-61).

2

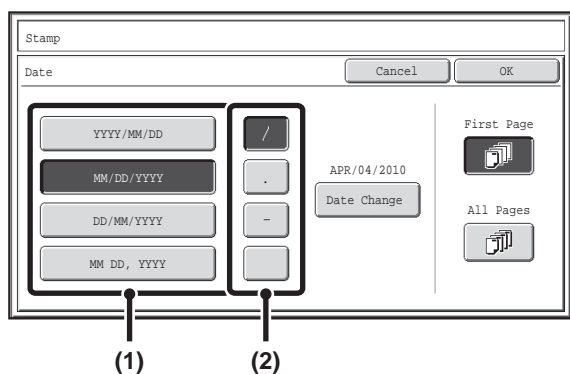

### Set the date format.

- (1) Touch the key that shows the desired date format.
- (2) If you selected [YYYY/MM/DD], [MM/DD/YYYY], or [DD/MM/YYYY], touch the [/], [·], [-], or [ ] key to select the separator.

3

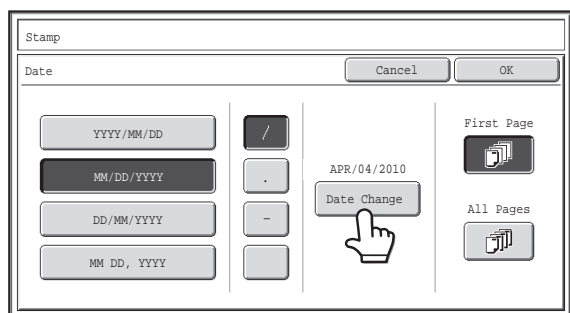

### Check the displayed date. If you need to change the date, touch the [Date Change] key.

Set the date that you wish to use and touch the [OK] key.

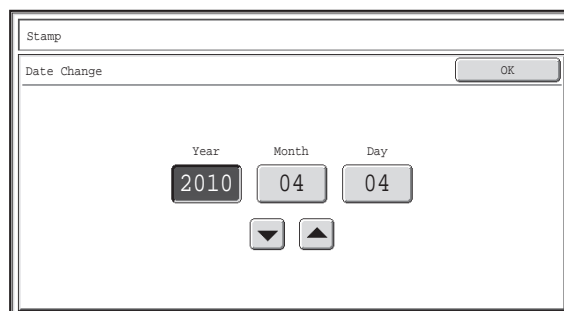

As an alternative to touching the keys, you can also directly touch the numeric value display key and change the value with the numeric keys.



- If you select a date that does not exist (such as Feb. 30), the [OK] key will be grayed out to prevent entry.
- Changing the date here will not change the date that is set in the machine using "Clock" in the system settings.

4

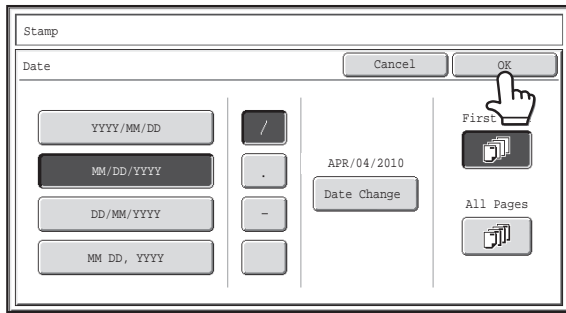

### Select the pages that the date will be printed on and touch the [OK] key.

Select printing on the first page only, or printing on all pages. After touching the [OK] key, continue from step 5 of "[GENERAL PROCEDURE FOR USING STAMP](#)" (page 2-61) to complete the copy procedure.



#### To cancel the date print setting...

Touch the [Cancel] key in the screen of step 2.

# STAMPING COPIES (Stamp)

Text such as "CONFIDENTIAL" can be printed in white on a dark background as a "stamp" on copies. The position, size, density, and pages (first page only or all pages) can be selected for a stamp.

Printing "CONFIDENTIAL" in the top left corner of a copy

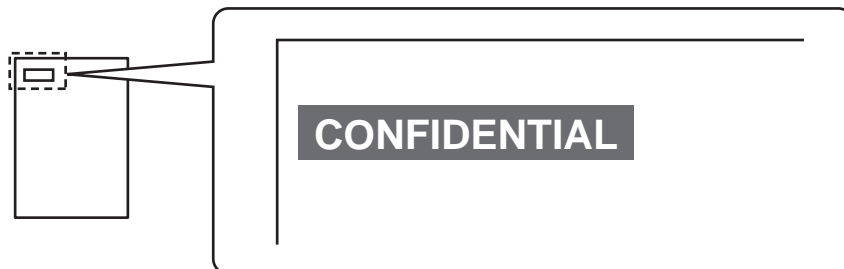

The following 12 selections are available for the stamp text.

CONFIDENTIAL	PRIORITY	PRELIMINARY	FINAL
FOR YOUR INFO.	DO NOT COPY	IMPORTANT	COPY
URGENT	DRAFT	TOP SECRET	PLEASE REPLY

Three levels can be selected for the density of the stamp background. Two stamp sizes can be selected.

1

**Touch the [Stamp] key in the stamp selection screen.**

See steps 1 to 4 of "GENERAL PROCEDURE FOR USING STAMP" (page 2-61).

2

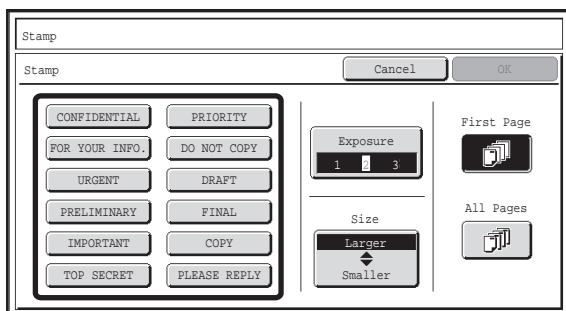

**Touch the key of the stamp that you wish to use.**

3

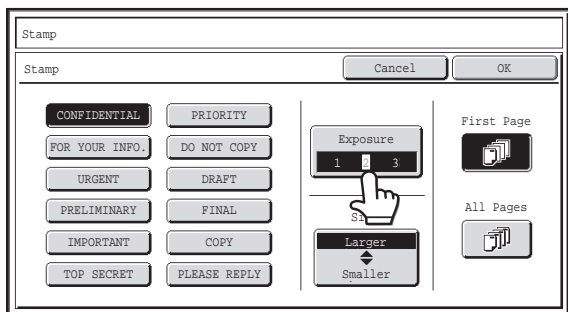

**Touch the [Exposure] key and set the density.**

If you wish to darken the image, touch the key. If you wish to lighten the image, touch the key.

When you have finished selecting the settings, touch the [OK] key.

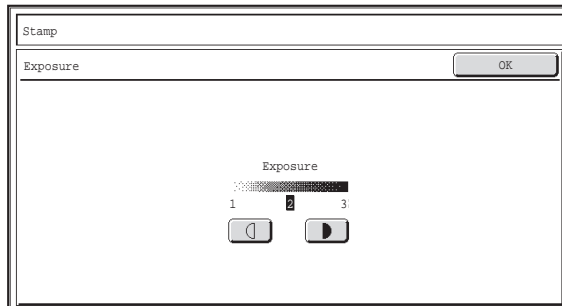

4

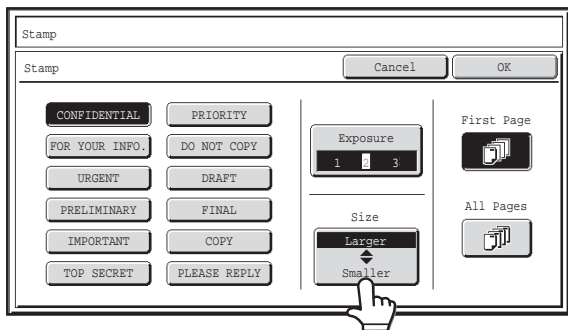

**Touch the [Larger  $\blacktriangle$  Smaller] key to select the size of the stamp.**

5

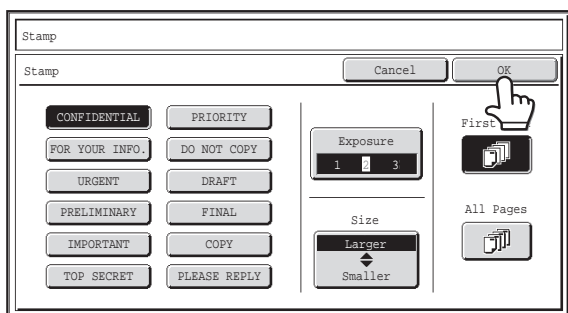

**Select the pages that the stamp will be printed on and touch the [OK] key.**

Select printing on the first page only, or printing on all pages. After touching the [OK] key, continue from step 5 of "GENERAL PROCEDURE FOR USING STAMP" (page 2-61) to complete the copy procedure.



The stamp text cannot be edited.



**To cancel a stamp setting...**

Touch the [Cancel] key in the screen of step 2.

# PRINTING PAGE NUMBERS ON COPIES (Page Numbering)

Page numbers can be printed on copies.

The position, format, and page number can be selected for page numbering.

Printing the page number at the bottom center of the paper.

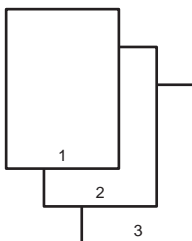

## 1 Touch the [Page Numbering] key in the stamp selection screen.

See steps 1 to 4 of "GENERAL PROCEDURE FOR USING STAMP" (page 2-61).

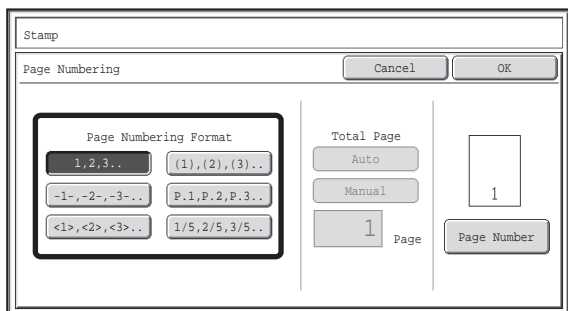

## Select a format for the page number.

If the [1/5, 2/5, 3/5] key is selected, "Page number / total pages" will be printed. "Auto" is initially selected for the total pages, which means that the number of scanned original pages is automatically set as the total pages. If you need to set the total pages manually, such as when a large number of originals are divided into sets for scanning, touch the [Manual] key to display the total pages entry screen.

## 2

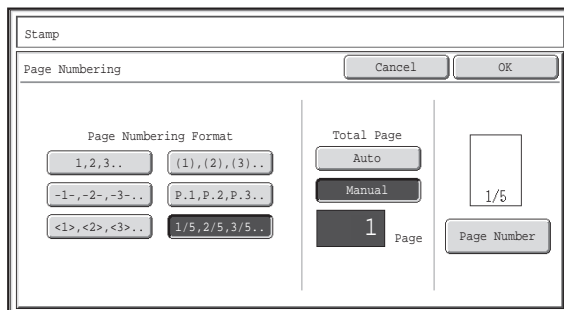

Enter the total pages (1 to 999) with the numeric keys and touch the [OK] key.

The [CLEAR] key (⊙) can be pressed to return the setting of the selected item to the default value. If you make a mistake, press the [CLEAR] key (⊙) and then enter the correct number.



- When 2-sided copying is performed, the total pages is the total number of sides of the paper. If the final page is blank, it is not counted.
- When used in combination with "2in1", or "Card Shot", the number of sides of the paper copied on is the total pages.
- When used in combination with "Pamphlet Copy", the total number of pages in the resulting pamphlet or booklet is the total pages.

3

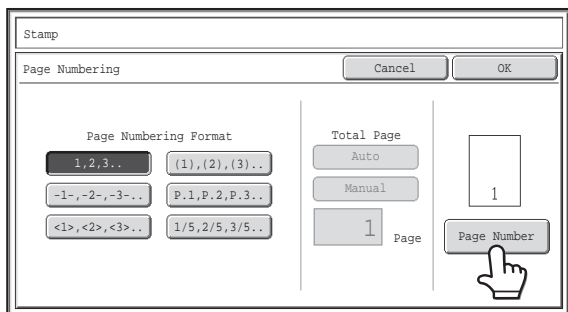

**To configure page number settings, touch the [Page Number] key.**

If you do not need to configure page number settings, go to step 5.

4

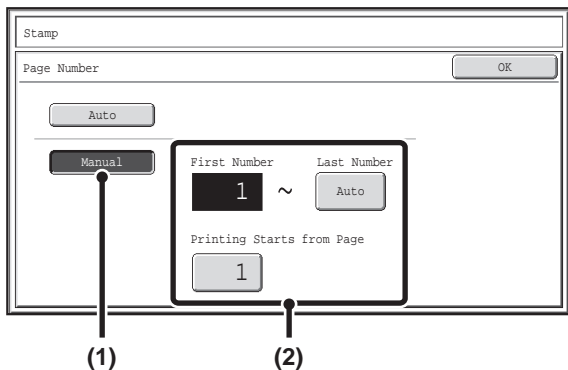

**Select page number settings.**

- (1) Touch the [Manual] key.
- (2) Set the first number, the last number, and the "Printing Starts from Page" number.

Touch each key and enter a number with the numeric keys (1 to 999).

The [CLEAR] key (Ⓢ) can be pressed to return the setting of the selected item to the default value. If you make a mistake, press the [CLEAR] key (Ⓢ) and then enter the correct number.



- A "Last Number" smaller than the "First Number" cannot be set.
- The "Last Number" is initially set to "Auto", which means that page numbers are automatically printed through the last page based on the "First Number" and "Printing Start from Page" settings.
- If the "Last Number" is set to a number smaller than the "Total Pages", page numbers are not printed on pages after the page set as the "Last Number".
- "Printing Starts from Page" is used to set the page number from which you want to begin printing page numbers. For example, if "3" is set and 1-sided copying is being performed, page numbers will be printed beginning from the 3rd copy sheet (the 3rd original page). If 2-sided copying is being performed, page numbers will be printed beginning from the front side of the 2nd copy sheet (the 3rd original page).

5

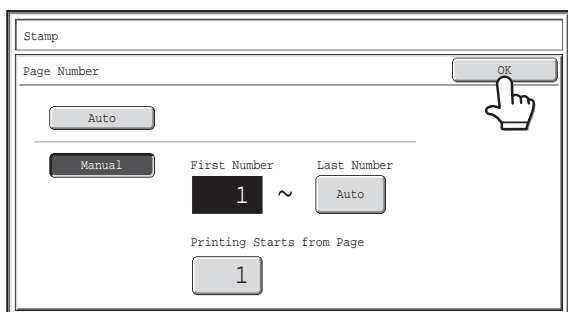

**Touch the [OK] key.**

6

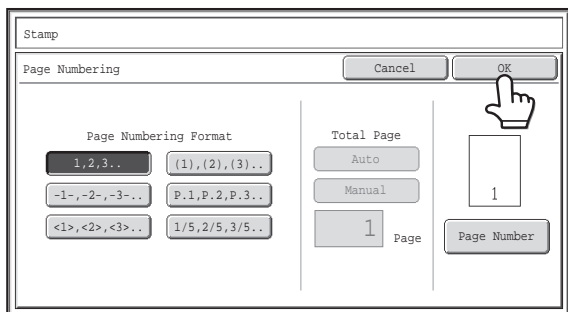

**Touch the [OK] key.**

After touching the [OK] key, continue from step 5 of "GENERAL PROCEDURE FOR USING STAMP" (page 2-61) to complete the copy procedure.

- When Page Numbering is selected, copying in group mode is not possible. The mode automatically changes to sort mode.
- When the page number printing position is set to the right side or left side and pamphlet copy is used, the print position is changed so that the page numbers always appear on the outer side of each opened page (the left and right sides of the opened pages). If a stamp is set in the area where page numbering is set, the position of the stamp changes in the same way as the page number.

If another stamp item is set in this changing position, the page numbers will alternate sides with this stamp item. A stamp item that is in a position not affected by the changing page number position will be printed in its original set position.

Example: When four pages are copied using pamphlet copy and the page number format is "1, 2, 3...", the result is as follows:

In this example, the page number is set at the bottom of the page and the date is set at the top, and thus the date does not move.

**Print settings**

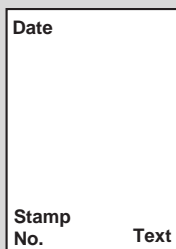

**Side 1**

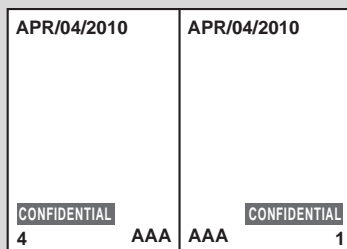

**Side 2**

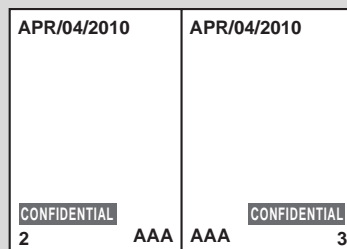

**To cancel the page numbering setting...**

Touch the [Cancel] key in the screen of step 2.



# PRINTING TEXT ON COPIES (Text)

Entered text can be printed on copies. Up to 30 frequently used text strings can be stored.

**Example: Printing "April 2010 Planning Meeting" in the top left corner of the paper**

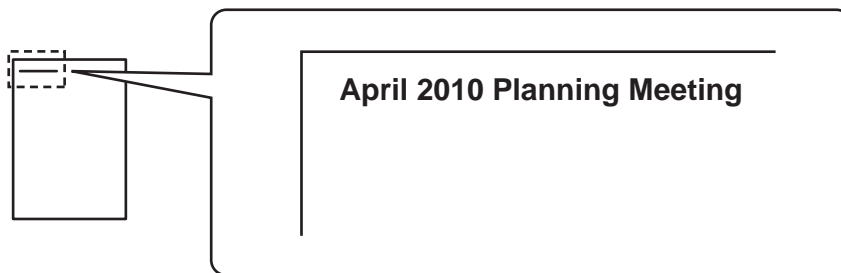

## 1 Touch the [Text] key in the stamp selection screen.

See steps 1 to 4 of "GENERAL PROCEDURE FOR USING STAMP" (page 2-61).

## 2

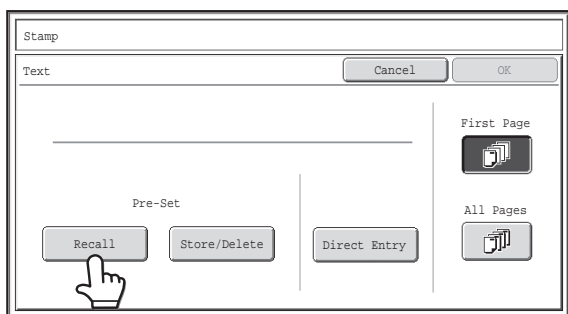

## Touch the [Recall] key.

The [Direct Entry] key can be touched to display the text entry screen. When all characters have been entered, touch the [OK] key.

To store or delete a text string, touch the [Store/Delete] key.  
 ➤ [Storing, editing, and deleting text strings](#) (page 2-73)

## 3

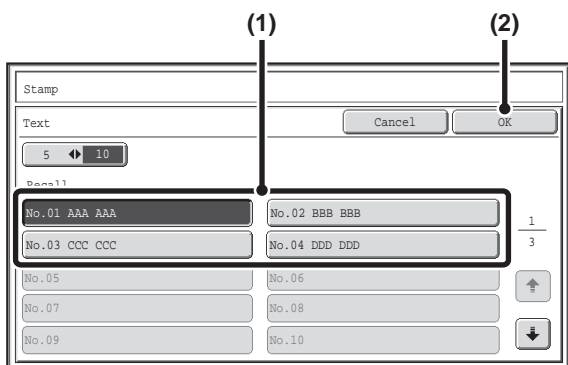

## Specify the text to be printed.

### (1) Touch the text string that you wish to select.

You can touch the [5 ◀▶ 10] key to switch the number of keys displayed in the screen between 5 and 10. When 5-key display is selected, the entire text string appears in each key.

### (2) Touch the [OK] key.

4

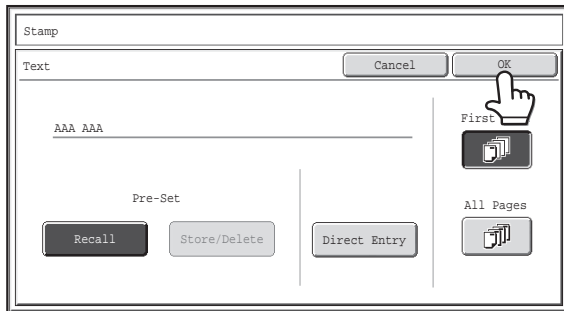

### Select the pages to be printed on and touch the [OK] key.

Select printing on the first page only, or printing on all pages. After touching the [OK] key, continue from step 5 of "[GENERAL PROCEDURE FOR USING STAMP](#)" (page 2-61) to complete the copy procedure.

 Text settings can also be configured in the Web pages. Click [Application Settings], [Copy settings] and then [Text Settings (Stamp)] in the Web page menu.

 **To cancel a text setting...**  
Touch the [Cancel] key in the screen of step 2.

# Storing, editing, and deleting text strings

## 1 Touch the [Text] key in the stamp selection screen.

See steps 1 to 4 of "GENERAL PROCEDURE FOR USING STAMP" (page 2-61).

## 2



Touch the [Store/Delete] key.

## Store a text string, or edit/delete a stored text string.

- To store a text string, touch a key with no text stored. A text entry screen will appear. A maximum of 50 characters can be entered. When you have finished entering the text, touch the [OK] key. The text entry screen will close.
- To edit or delete a text string, follow the instructions below.

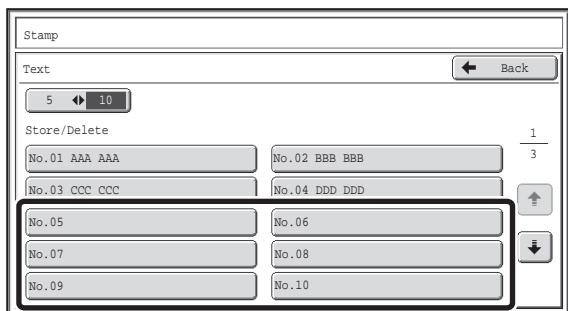

## 3

### To edit or delete a text string...

- When the key with the text string is touched, the following screen appears. When the [Modify] key is touched, a text entry screen appears. The stored text string appears in the text entry screen. Edit the text. When you have finished entering the text, touch the [OK] key. The text entry screen will close.
- When the [Delete] key is touched, the stored text is deleted.

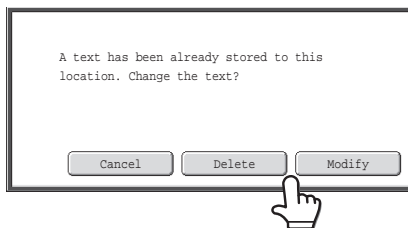

- Text settings can also be configured in the Web pages. Click [Application Settings], [Copy settings] and then [Text Settings (Stamp)] in the Web page menu.

4

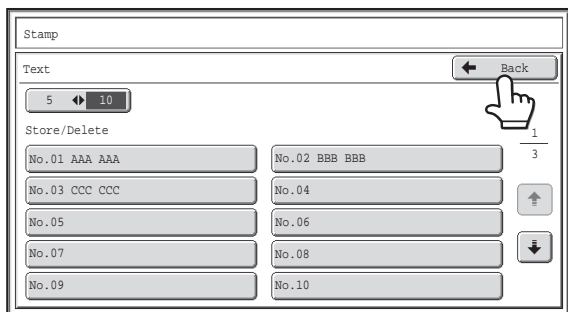

**Touch the [Back] key.**

You will return to the screen of step 2.

To copy using a stored text string, continue from step 2 of "PRINTING TEXT ON COPIES (Text)" (page 2-71).

# CHECKING THE STAMP LAYOUT (Layout)

After stamp items have been selected, you can check the print layout, change the print position, and delete stamp items.

1

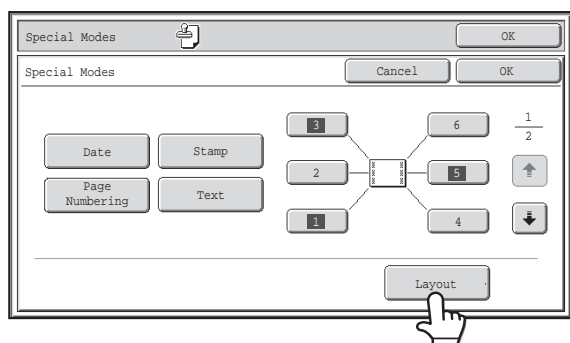

Touch the [Layout] key.



The [Layout] key can only be touched when stamp items have been selected.

2

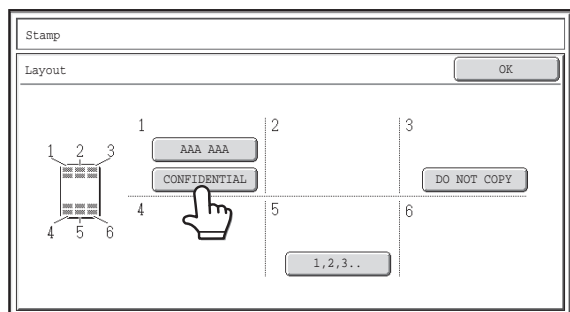

If the layout is correct, touch the [OK] key.

Touch the key of the stamp item that you want to delete or whose position you want to change.



A maximum of 14 characters appear in each key.

3

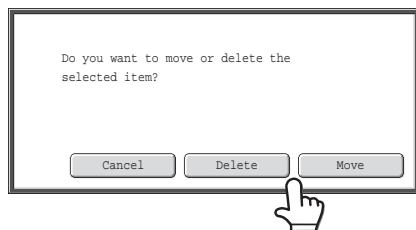

To change the position of the item, touch the [Move] key. To delete the item, touch the [Delete] key.

- If the [Move] key is touched, a screen for selecting the destination position appears.
- If the [Delete] key is touched, the item is deleted. (Go to step 6.)

4

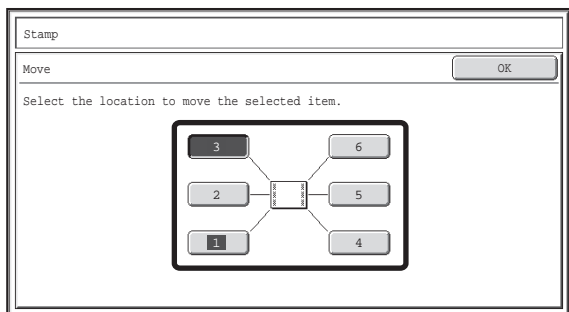

**Touch the key of the desired destination position.**

The touched position key is highlighted and the print position changes.

The keys that show the print positions will appear as follows depending on the state of the settings.

	Not selected, stamp setting has not been selected.
	Selected during selection of the stamp setting.
	Not available, stamp setting has already been selected.



If you wish to swap the position of the selected stamp item with the position of another stamp item, temporarily move either one of the items to an unoccupied position and then switch the print positions.

5

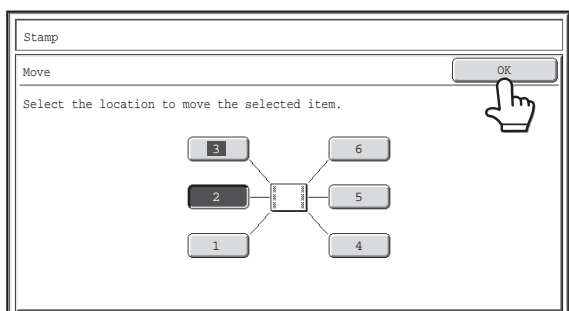

**Touch the [OK] key.**

If you attempt to move the stamp item to a position that is already occupied by another stamp item, a message will appear asking you if you wish to overwrite the other stamp item. To overwrite the other stamp item, touch the [Yes] key. To cancel the move, touch the [No] key.

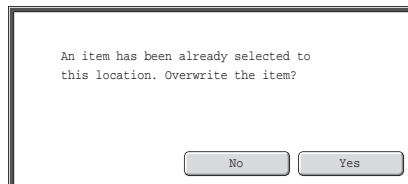

6

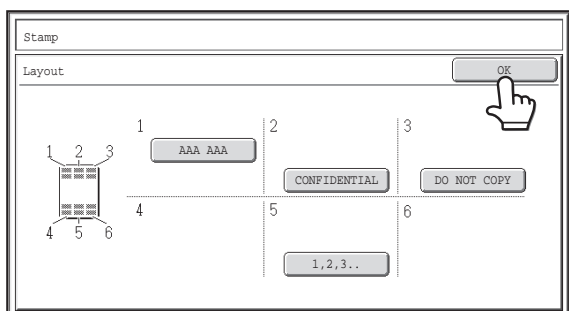

**Touch the [OK] key.**

# [Image Edit] KEY

When the [Image Edit] key is touched in the 1st special modes menu screen, the image edit menu screen opens.

## Image edit menu screen

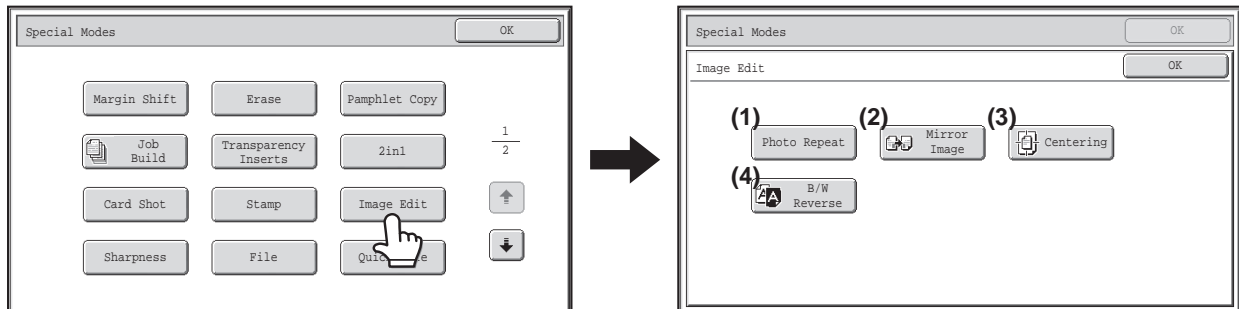

**(1) [Photo Repeat] key**

☞ [REPEATING PHOTOS ON A COPY \(Photo Repeat\)](#)  
(page 2-78)

**(2) [Mirror Image] key**

☞ [REVERSING THE IMAGE \(Mirror Image\)](#) (page  
2-80)

**(3) [Centering] key**

☞ [COPYING IN THE CENTER OF THE PAPER](#)  
(Centering) (page 2-81)

**(4) [B/W Reverse] key**

☞ [REVERSING BLACK AND WHITE IN A COPY \(B/W  
Reverse\)](#) (page 2-83)

# REPEATING PHOTOS ON A COPY (Photo Repeat)

Photo Repeat is used to create repeated images of a photo-size original (3" x 5" size, 5" x 7" size, 2-1/2" x 4" size, 2-1/2" x 2-1/2" size or 2-1/8" x 2-5/8" size (130 mm x 90 mm size, 100 mm x 150 mm size, 70 mm x 100 mm size, 65 mm x 70 mm size or 57 mm x 100 mm size)) on a single sheet of copy paper as shown below. Up to 12 images (when the image is 2-1/2" x 2-1/2" size (65 mm x 70 mm size)) can be repeated on a single sheet of paper.

- Original sizes up to 3" x 5" (130 mm x 90 mm)



- Original sizes up to 2-1/2" x 4" (70 mm x 100 mm)



- Original sizes up to 2-1/8" x 2-5/8" (57 mm x 100 mm)



- Original sizes up to 5" x 7" (100 mm x 150 mm)



- Original sizes up to 2-1/2" x 2-1/2" (65 mm x 70 mm)

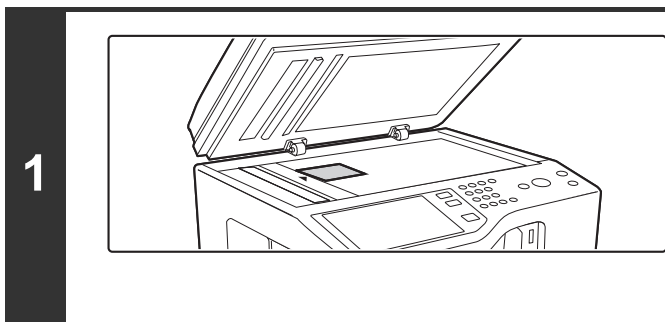

## Place the original face down on the document glass.

- When placing a 3" x 5" or 2-1/2" x 2-1/2" (130 mm x 90 mm or 65 mm x 70 mm) photo size original, place the original with the short side aligned against the left side of the document glass.
- When placing a 5" x 7" (100 mm x 150 mm) or business card size original, place with the longest side aligned against the left side of the document glass.

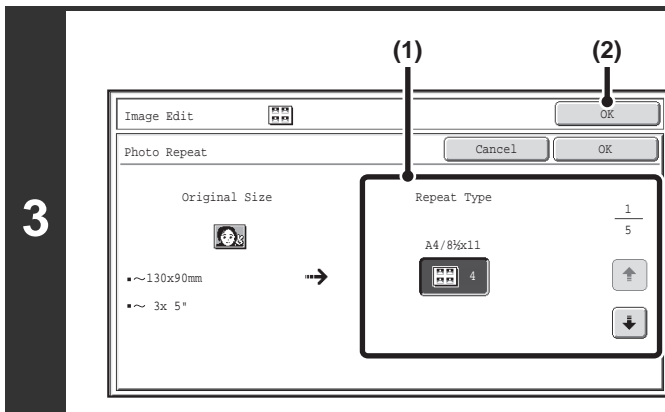

## Select Photo Repeat settings.

- (1) Touch the key showing the original type and paper size combination that you want to use. Touch the keys to switch through the screens and touch the desired repeat type key.
- (2) Touch the [OK] key. You will return to the special modes screen. Touch the [OK] key to return to the base screen of copy mode.



4

**Press the [START] key.**

Copying will begin.

If you have selected sort mode, change originals and press the [START] key. Repeat until all pages have been scanned and then touch the [Read-End] key.

**To cancel scanning and copying...**

Press the [STOP] key (⏹).



- The original must be placed on the document glass.
- Only 8-1/2" x 11" (A4) size paper can be used.
- The copy ratio is 100% when this function is used. (The ratio cannot be changed.) However, for a business card size original (up to 2-1/8" x 2-5/8" (57 mm x 100 mm)), the images are reduced to 95%.

**To cancel the photo repeat setting...**

Touch the [Cancel] key in the screen of step 3.

# REVERSING THE IMAGE (Mirror Image)

This feature is used to make a copy that is a mirror image of the original.

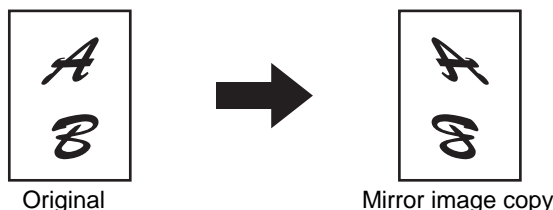

1

## Place the original.

Place the original face up in the document feeder tray, or face down on the document glass.

Place the original in the automatic document feeder.

☞ [PLACING ORIGINALS IN THE AUTOMATIC DOCUMENT FEEDER](#) (page 1-37)

After placing the original, specify the original size.

☞ [ORIGINAL SIZES](#) (page 2-29)

2

## Select the special modes.

(1) Touch the [Special Modes] key.

(2) Touch the [Image Edit] key.

☞ [\[Image Edit\] KEY](#) (page 2-77)

3

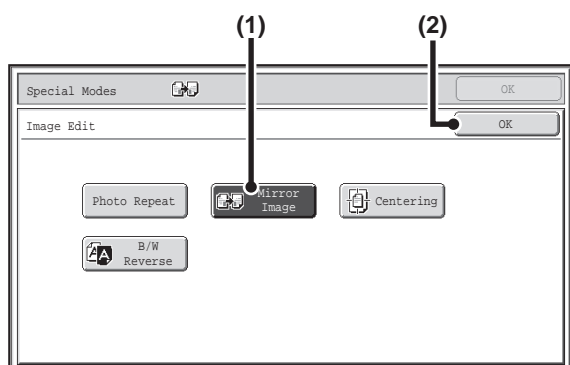

## Select Mirror Image.

(1) Touch the [Mirror Image] key so that it is highlighted.

(2) Touch the [OK] key.

You will return to the special modes screen. Touch the [OK] key to return to the base screen of copy mode.

4

## Press the [START] key.

Copying will begin.

If you are using the document glass to copy multiple original pages, copying will take place as you scan each original. If you have selected sort mode, change originals and press the [START] key. Repeat until all pages have been scanned and then touch the [Read-End] key.

☞ **To cancel scanning and copying...**  
Press the [STOP] key (⏹).





### To cancel a mirror image setting...

Touch the [Mirror Image] key in the screen of step 3 so that it is not highlighted.

# COPYING IN THE CENTER OF THE PAPER (Centering)

This is used to center the copied image on the paper.

This lets you place the image in the center of the paper when the original size is smaller than the paper size or when the image is reduced.

Not using the centering function	Using the centering function
	

**1 Place the original.**

Place the original face up in the document feeder tray, or face down on the document glass.  
 Place the original in the automatic document feeder.  
 ⓘ [PLACING ORIGINALS IN THE AUTOMATIC DOCUMENT FEEDER](#) (page 1-37)  
 After placing the original, specify the original size.  
 ⓘ [ORIGINAL SIZES](#) (page 2-29)

**2 Select the special modes.**

(1) Touch the [Special Modes] key.  
 (2) Touch the [Image Edit] key.  
 ⓘ [\[Image Edit\] KEY](#) (page 2-77)

**3 Select Centering.**

(1) Touch the [Centering] key so that it is highlighted.  
 (2) Touch the [OK] key.

You will return to the special modes screen. Touch the [OK] key to return to the base screen of copy mode.

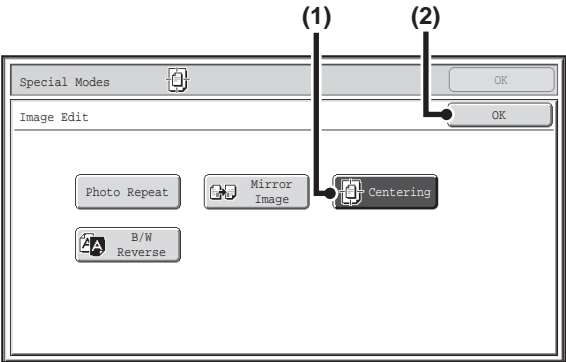

**4 Press the [START] key.**

Copying will begin.  
 If you are using the document glass to copy multiple original pages, copying will take place as you scan each original. If you have selected sort mode, change originals and press the [START] key. Repeat until all pages have been scanned and then touch the [Read-End] key.

**To cancel scanning and copying...**  
 Press the [STOP] key (⏏).



- The image can be reduced when using the centering function, but not enlarged.
- When the original size or the paper size is displayed as a special size, this function cannot be used.

**To cancel centering...**

Touch the [Centering] key in the screen of step 3 so that it is not highlighted.

# REVERSING BLACK AND WHITE IN A COPY (B/W Reverse)

This is used to reverse black and white in a copy to create a negative image.

Originals with large black areas (which use a large amount of toner) can be copied using Black/White Reverse to reduce toner consumption.

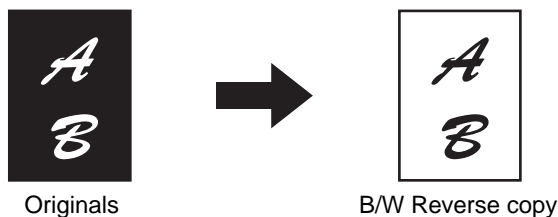

## 1 Place the original.

Place the original face up in the document feeder tray, or face down on the document glass.

Place the original in the automatic document feeder.

➤ [PLACING ORIGINALS IN THE AUTOMATIC DOCUMENT FEEDER](#) (page 1-37)

After placing the original, specify the original size.

➤ [ORIGINAL SIZES](#) (page 2-29)

## 2 Select the special modes.

(1) Touch the [Special Modes] key.

(2) Touch the [Image Edit] key.

➤ [\[Image Edit\] KEY](#) (page 2-77)

## 3

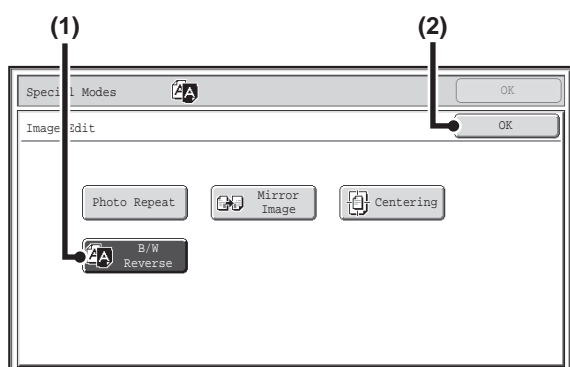

## Select B/W Reverse.

(1) Touch the [B/W Reverse] key so that it is highlighted.

(2) Touch the [OK] key.

You will return to the special modes screen. Touch the [OK] key to return to the base screen of copy mode.

## 4 Press the [START] key.

Copying will begin.

If you are using the document glass to copy multiple original pages, copying will take place as you scan each original. If you have selected sort mode, change originals and press the [START] key. Repeat until all pages have been scanned and then touch the [Read-End] key.

➤ **To cancel scanning and copying...**  
Press the [STOP] key (⏹).



When this function is selected, the "Original Image Type" setting for exposure adjustment automatically changes to "Text".



**To cancel B/W reverse...**

Touch the [B/W Reverse] key in the screen of step 3 so that it is not highlighted.

# ADJUSTING THE SHARPNESS OF AN IMAGE (Sharpness)

This is used to sharpen an image or make it softer.

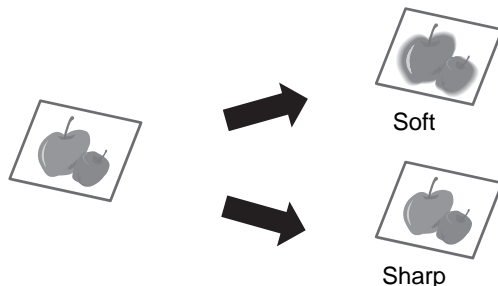

## 1 Place the original.

Place the original face up in the document feeder tray, or face down on the document glass.

Place the original in the automatic document feeder.

➤ [PLACING ORIGINALS IN THE AUTOMATIC DOCUMENT FEEDER](#) (page 1-37)

After placing the original, specify the original size.

➤ [ORIGINAL SIZES](#) (page 2-29)

## 2 Select the special modes.

(1) Touch the [Special Modes] key.

(2) Touch the [Sharpness] key.

➤ [Special modes menu \(1st screen\)](#) (page 2-41)

## Adjust the image.

(1) Touch the [Soft] key or the [Sharp] key.

(2) Touch the [OK] key.

You will return to the base screen of copy mode.

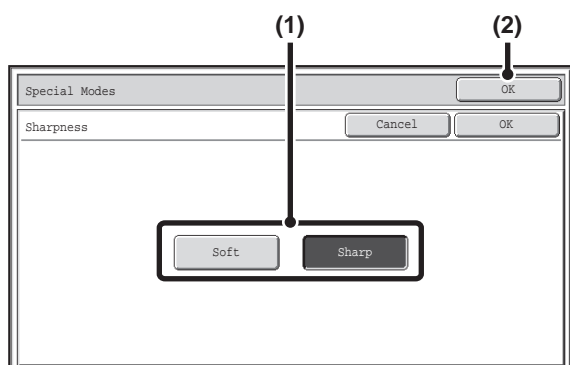

4

**Press the [START] key.**

Copying will begin.

If you are using the document glass to copy multiple original pages, copying will take place as you scan each original. If you have selected sort mode, change originals and press the [START] key. Repeat until all pages have been scanned and then touch the [Read-End] key.

**To cancel scanning and copying...**

Press the [STOP] key (⏹).



When this function is selected, the "Original Image Type" setting for exposure adjustment automatically changes to "Text/Prtd.Photo".

**To cancel the sharpness setting...**

Touch the [Cancel] key in the screen of step 3.



# CHECKING COPIES BEFORE PRINTING (Proof Copy)

This feature prints only one set of copies, regardless of how many sets have been specified. After the first set is checked for errors, the remaining sets can be printed. Previously it was necessary to re-scan the original each time changes to settings were required. However, this feature makes it possible to change settings for the scanned original without scanning it again, allowing you perform copying more efficiently.

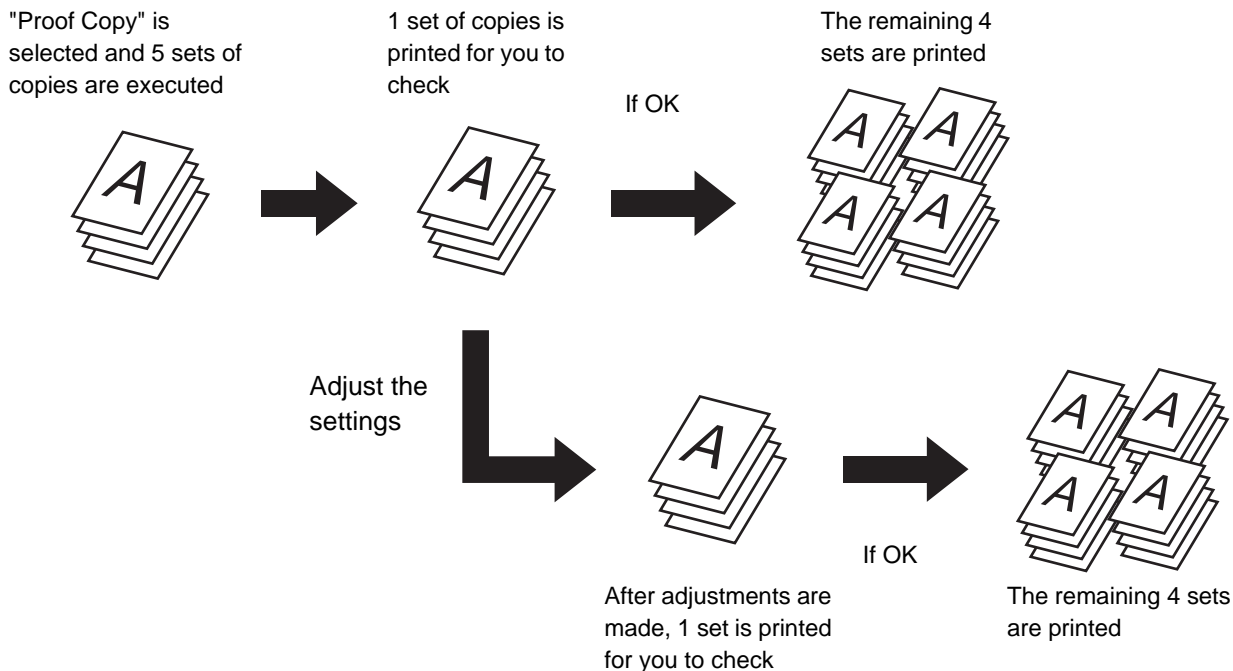

## 1 Place the original.

Place the original face up in the document feeder tray, or face down on the document glass.

Place the original in the automatic document feeder.

☞ [PLACING ORIGINALS IN THE AUTOMATIC DOCUMENT FEEDER](#) (page 1-37)

After placing the original, specify the original size.

☞ [ORIGINAL SIZES](#) (page 2-29)

## 2 Select copy settings in the base screen.

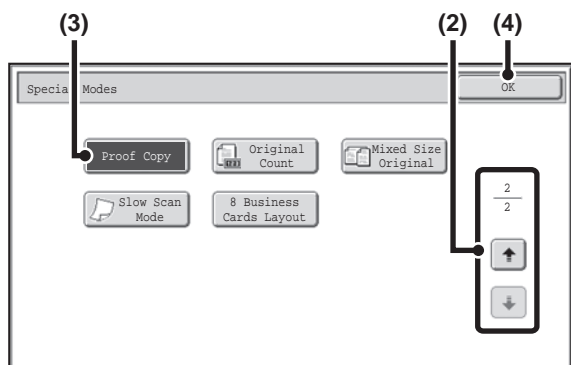

## Select Proof Copy.

(1) Touch the [Special Modes] key.

☞ [SPECIAL MODES](#) (page 2-41)

(2) Touch the keys to switch through the screens.

(3) Touch the [Proof Copy] key so that it is highlighted.

(4) Touch the [OK] key.

4

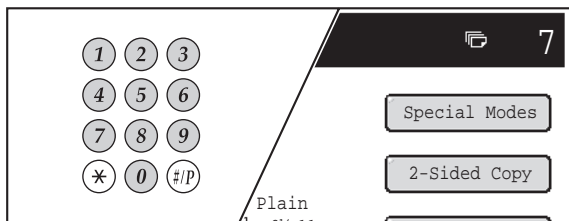

**Set the number of copies (number of sets) with the numeric keys.**

If you will copy multiple originals using the document glass, switch to sort mode after this step.

☞ [Sort mode](#) (page 2-36)

Up to 999 copies (sets) can be set.

**If an incorrect number of copies is set...**  
Press the [CLEAR] key (Ⓢ) and then enter the correct number.

5

**Press the [START] key.**

One set of copies is printed.

If you are using the document glass to copy multiple originals, change originals and press the [START] key. Repeat until all pages have been scanned and then touch the [Read-End] key. One set of copies will be printed.

**To cancel copying...**  
Press the [STOP] key (Ⓢ).

6

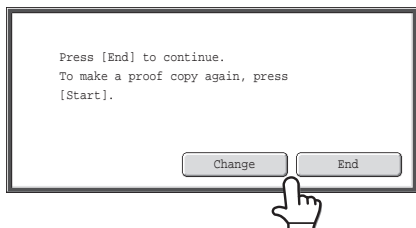

**Check the printed set of copies. If the copies are acceptable, touch the [End] key. If you need to change the settings, touch the [Change] key.**

When the [End] key is touched, the remaining sets are printed. If you touched the [Change] key, go to the next step.

**To cancel copying...**  
Press the [STOP] key (Ⓢ).

7

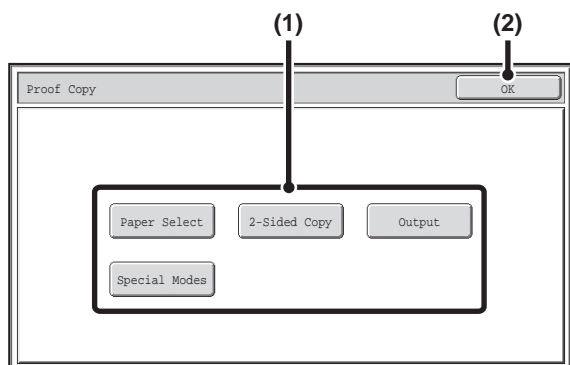

**Change the settings.**

**(1) Touch the key of the setting that you want to change.**

The setting screen of the touched key opens. Change the settings and touch the [OK] key.

**(2) Touch the [OK] key.**



- To change the number of sets printed, set the desired number of copies (sets) with the numeric keys. After changing the number of sets, touch the [End] key in the touch panel (not the [START] key) to print the sets.
- Special modes that can be adjusted are Margin Shift, Pamphlet Copy, Transparency Inserts, 2in1, and Stamp.
- For Pamphlet Copy, and 2in1, only changes to the settings of the functions can be made; the functions cannot be newly added or deleted.
- When transparency film is used, the settings can be changed, new settings can be added, and the function can be canceled. However, this is not possible when pamphlet copying is enabled.

8

**Press the [START] key.**

One set of copies is printed again using the adjusted settings. Check the results. If further adjustments are needed, repeat steps 6 through 8. (Repeating Proof Copy does not decrease the remaining number of sets to be printed.)

9

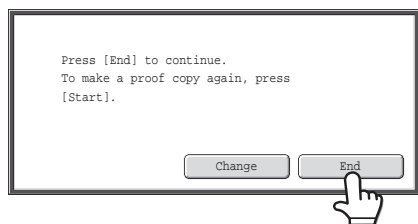

**Touch the [End] key.**

You will return to the base screen of copy mode and the remaining sets will be printed.



**To cancel scanning and copying...**

Press the [STOP] key (⏹).



If Proof Copy is executed while the machine is printing another job, the other job is interrupted and the proof copies are printed. The previous job will resume after the proof copies are printed. However, if proof copy is executed during output of a job for which both two-sided printing and stapling are enabled, the proof copy will be output after the job in progress is finished. If the [End] key is touched to execute printing of the remaining sets while the machine is printing another job, the remaining sets will be printed after all previously reserved jobs are completed.

# CHECKING THE NUMBER OF SCANNED ORIGINAL SHEETS BEFORE COPYING (Original Count)

The number of scanned original sheets can be counted and displayed before copying is executed. By allowing you to check the number of original sheets that were scanned, this helps reduce the occurrence of copy mistakes.

MX-B402

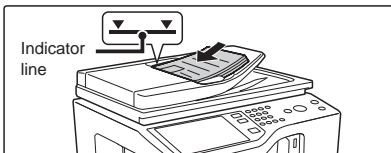

1

MX-B402SC

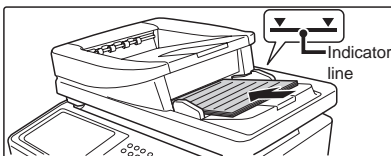

## Insert the originals face up in the document feeder tray.

Place the original in the automatic document feeder.

➤ [PLACING ORIGINALS IN THE AUTOMATIC DOCUMENT FEEDER](#) (page 1-37)

## Select Original Count.

(1) Touch the [Special Modes] key.

➤ [SPECIAL MODES](#) (page 2-41)

(2) Touch the keys to switch through the screens.

(3) Touch the [Original Count] key so that it is highlighted.

(4) Touch the [OK] key.

You will return to the base screen of copy mode.

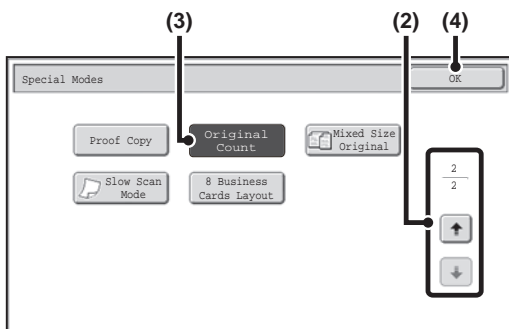

2

## Press the [START] key.

3



To cancel scanning and copying...

Press the [STOP] key ().

## After scanning is finished, check the number of sheets that were scanned and touch the [OK] key.

Copying will begin.

- When job build mode is used, the number of scanned sheets appears when the [Read-End] key is touched.
- The number that is displayed is the number of scanned original sheets, not the number of scanned original pages. For example, when two-sided copying is performed using one original, the number "1" will appear to indicate that one original sheet was scanned, not "2" to indicate the front-side page and the reverse side page.

4

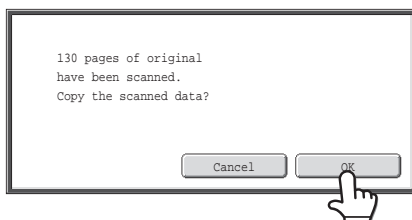

If the displayed number of original sheets is different from the actual number of original sheets...

Press the [STOP] key ().



To cancel the original count mode setting...

Touch the [Original Count] key in the screen of step 2 so that it is not highlighted.

# COPYING ORIGINALS OF DIFFERENT SIZES (Mixed Size Original)

Originals that are 8-1/2" x 14" size and 8-1/2" x 11" size, 8-1/2" x 11" size and 5-1/2" x 8-1/2" size (A4 size and A5 size) can be placed together in the automatic document feeder and copied.

When scanning the originals, the machine automatically detects the size of each original and uses paper appropriate for that size.

When mixed size original is combined with auto ratio selection, the ratio is adjusted individually for each original according to the selected paper size, enabling output on a uniform paper size.

For mixed originals, the only combination of sizes that can be used is 8-1/2" x 11" and 8-1/2" x 14", 5-1/2" x 8-1/2" and 8-1/2" x 11" (A5 and A4).

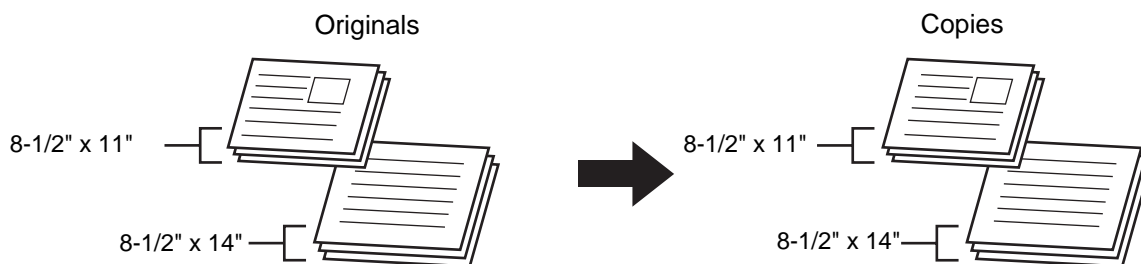

**When mixed size original is combined with auto ratio selection**  
(Auto ratio selection and 8-1/2" x 14", 8-1/2" x 11" (A4) are selected)

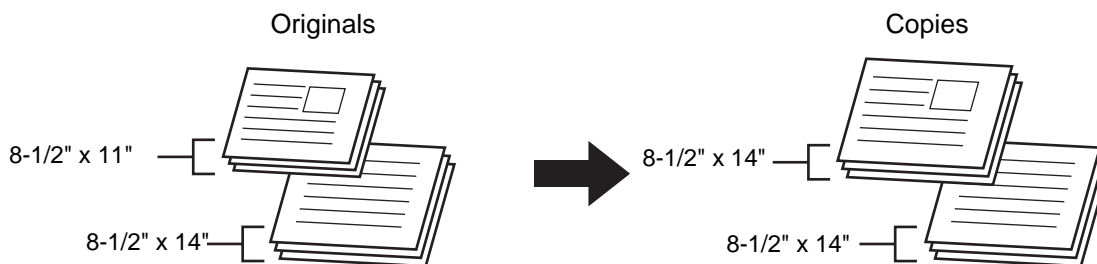

An 8-1/2" x 11", 5-1/2" x 8-1/2" (A5) size original will be enlarged to 8-1/2" x 14", 8-1/2" x 11" (A4) size.

1

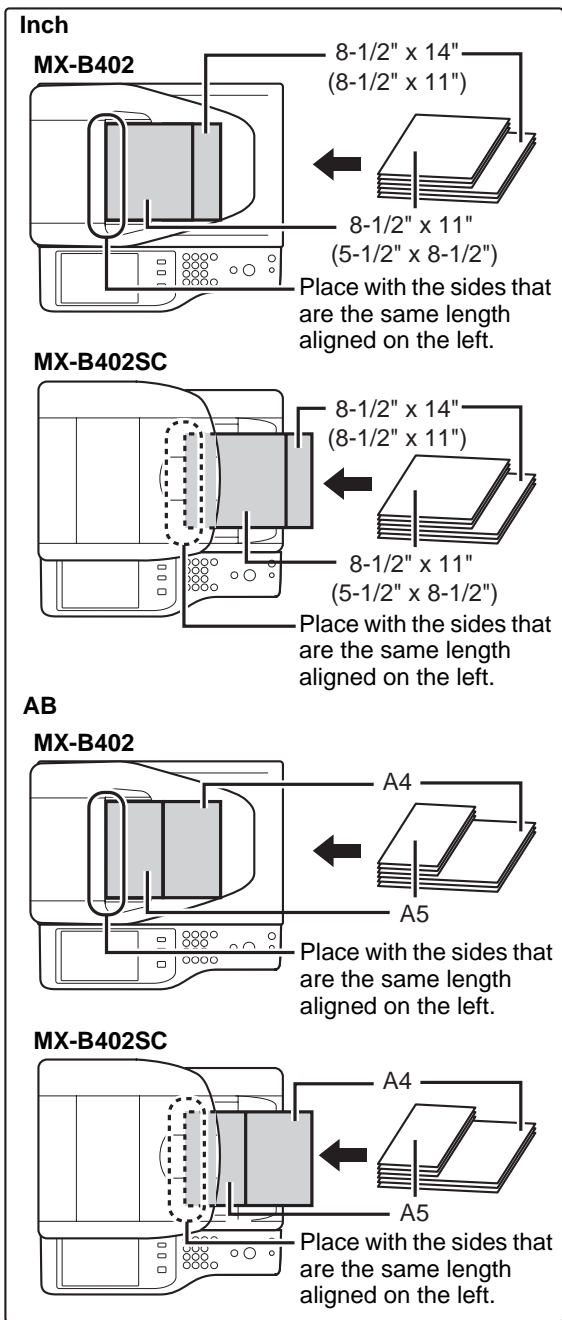

**Insert the originals face up in the document feeder tray.**

Place the originals with the sides that are the same length aligned on the left.

2

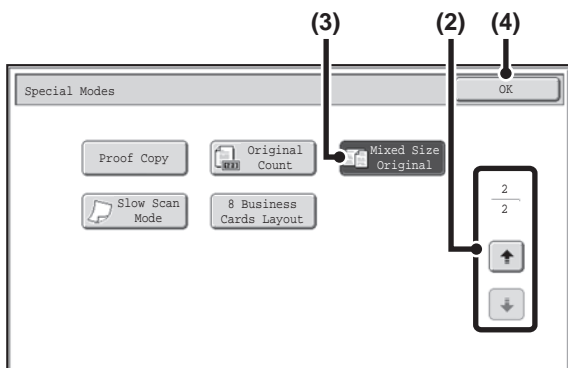

**Select the special modes.**

- (1) Touch the [Special Modes] key.  
 See [SPECIAL MODES](#) (page 2-41)
- (2) Touch the keys to switch through the screens.
- (3) Touch the [Mix Size Original] key so that it is highlighted.
- (4) Touch the [OK] key.  
 You will return to the base screen of copy mode.

**Press the [START] key.**

Copying will begin.

**3****To cancel scanning and copying...**

Press the [STOP] key (⏹).

**To cancel the mixed size original setting...**

Touch the [Cancel] key in the screen of step 2.

**System Settings (Administrator): Original Feeding Mode**

The original feeding mode can be set to always scan mixed size originals.

# COPYING THIN ORIGINALS (Slow Scan Mode)

Use this function when you wish to scan thin originals using the automatic document feeder. This function helps prevent thin originals from misfeeding.

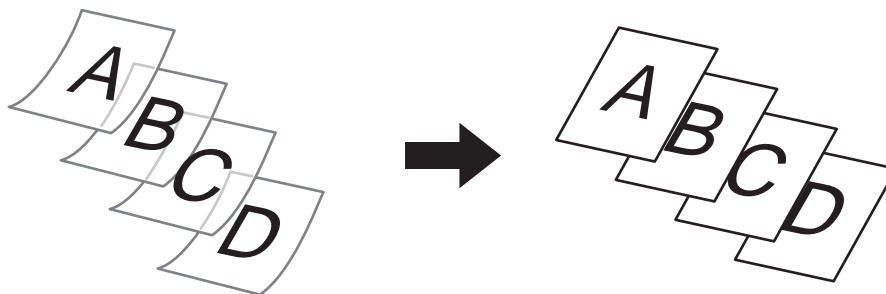

## 1 Insert the originals face up in the document feeder tray.

Place the original in the automatic document feeder.

➤ [PLACING ORIGINALS IN THE AUTOMATIC DOCUMENT FEEDER](#) (page 1-37)

After placing the original, specify the original size.

➤ [ORIGINAL SIZES](#) (page 2-29)

1



If the originals are inserted with too much force, they may crumple and misfeed.

2

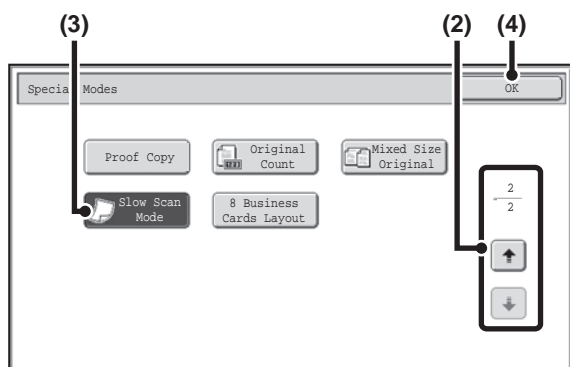

## Select Slow Scan Mode.

(1) Touch the [Special Modes] key.

➤ [SPECIAL MODES](#) (page 2-41)

(2) Touch the keys to switch through the screens.

(3) Touch the [Slow Scan Mode] key so that it is highlighted.

(4) Touch the [OK] key.

You will return to the base screen of copy mode.

## 3 Press the [START] key.

Copying will begin.

3



**To cancel scanning and copying...**

Press the [STOP] key ().



The "2-Sided to 2-Sided" and "2-Sided to 1-Sided" modes of automatic 2-sided copying cannot be used.



**To cancel the slow scan mode setting...**

Touch the [Slow Scan Mode] key in the screen of step 2 so that it is not highlighted.

**System Settings (Administrator): Original Feeding Mode**

This is used to have scanning always take place in slow scan mode.

# COPYING MULTIPLE BUSINESS CARDS (8 Business Cards Layout)

8 Business Cards Layout can be used to copy up to 8 business cards on one sheet of paper.

For the MX-B402, the business card feeder must be attached to the automatic document feeder and "Business Card Scan Option" must be enabled in the system settings (administrator) to use this function.

For the attachment procedure, see "[BUSINESS CARD FEEDER](#)" in "1. BEFORE USING THE MACHINE" (page 1-47). Use this function to create a list of business cards or to file business cards as a group.

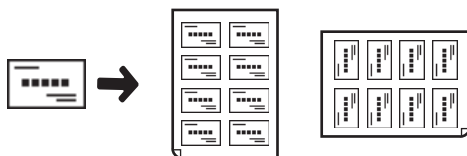

8 Business Cards Layout

## MX-B402

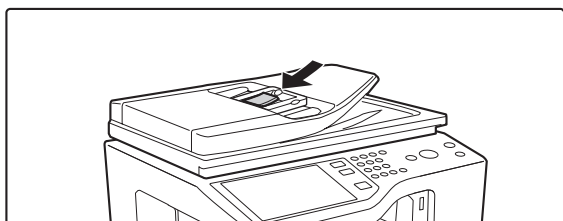

## Load the business cards.

Set in the business card feeder with MX-B402.

For original placement orientations and copy results, see "[Copy results of 8 Business Cards Layouts](#)" (page 2-98.)

1

## MX-B402SC

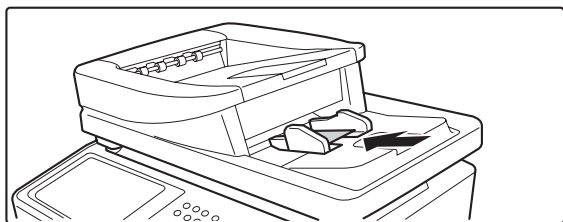

## Select 8 Business Cards Layout.

(1) Touch the [Special Modes] key.

[SPECIAL MODES](#) (page 2-41)

(2) Touch the keys to switch through the screens.

(3) Touch the [8 Business Cards Layout] key.

2

## Specify settings for 8 Business Cards Layout.

(1) Select the desired layout from "Layout".

(2) Touch the [OK] key.

You will return to the base screen of copy mode.

3

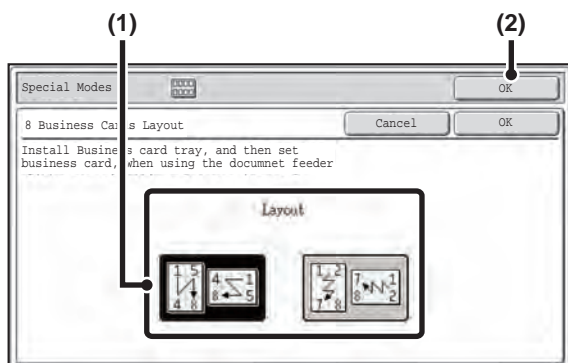

**Press the [START] key.**

Copying will begin.

**4****To cancel scanning and copying...**

Press the [STOP] key (⏹).



- For the MX-B402, the "2-Sided to 2-Sided", "2-Sided to 1-Sided" and "1-Sided to 2-Sided" modes of automatic 2-sided copying cannot be used.  
For the MX-B402SC, the "2-Sided to 2-Sided" and "1-Sided to 2-Sided" modes of automatic 2-sided copying cannot be used.
- The following functions and paper cannot be used.
  - Zoom function
  - Auto Image
  - Label

**To cancel the 8 Business Cards Layout setting...**

Touch the [Cancel] key in the screen of step 3.

**System Settings (Administrator): Business Card Scan Option (MX-B402 Only)**

Specify whether or not the 8 Business Cards Layout function is used.

# Copy results of 8 Business Cards Layouts

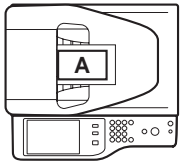
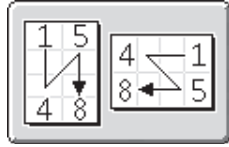
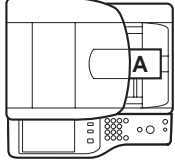
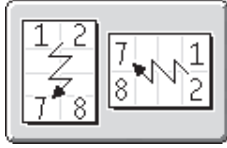
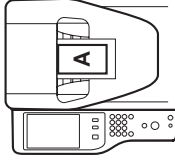
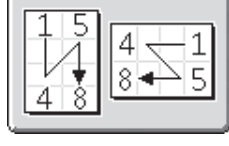
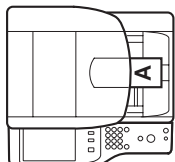
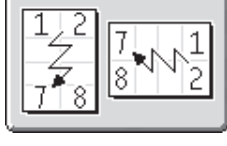
Originals (Original orientation)		Settings	Results								
1st page <b>A</b> 5th page <b>E</b> 2nd page <b>B</b> 6th page <b>F</b>	<b>MX-B402</b> 		<table border="1"> <tr><td>A</td><td>E</td></tr> <tr><td>B</td><td>F</td></tr> <tr><td>C</td><td>G</td></tr> <tr><td>D</td><td>H</td></tr> </table>	A	E	B	F	C	G	D	H
A	E										
B	F										
C	G										
D	H										
3rd page <b>C</b> 7th page <b>G</b> 4th page <b>D</b> 8th page <b>H</b>	<b>MX-B402SC</b> 		<table border="1"> <tr><td>A</td><td>B</td></tr> <tr><td>C</td><td>D</td></tr> <tr><td>E</td><td>F</td></tr> <tr><td>G</td><td>H</td></tr> </table>	A	B	C	D	E	F	G	H
A	B										
C	D										
E	F										
G	H										
1st page <b>A</b> 2nd page <b>B</b> 3rd page <b>C</b> 4th page <b>D</b>	<b>MX-B402</b> 		<table border="1"> <tr><td>D</td><td>C</td><td>B</td><td>A</td></tr> <tr><td>H</td><td>G</td><td>F</td><td>E</td></tr> </table>	D	C	B	A	H	G	F	E
D	C	B	A								
H	G	F	E								
5th page <b>E</b> 6th page <b>F</b> 7th page <b>G</b> 8th page <b>H</b>	<b>MX-B402SC</b> 		<table border="1"> <tr><td>G</td><td>E</td><td>C</td><td>A</td></tr> <tr><td>H</td><td>F</td><td>D</td><td>B</td></tr> </table>	G	E	C	A	H	F	D	B
G	E	C	A								
H	F	D	B								

# CONVENIENT COPY FUNCTIONS

This section explains convenient copy functions such as interrupting a copy run, changing the order of reserved copy jobs, and storing copy settings in a program.

## INTERRUPTING A COPY RUN (Interrupt copy)

When you need to make an urgent copy and the machine is busy with a long copy run or other job, use interrupt copy. Interrupt copy temporarily stops the job in progress and lets you perform the interrupt copy job first.

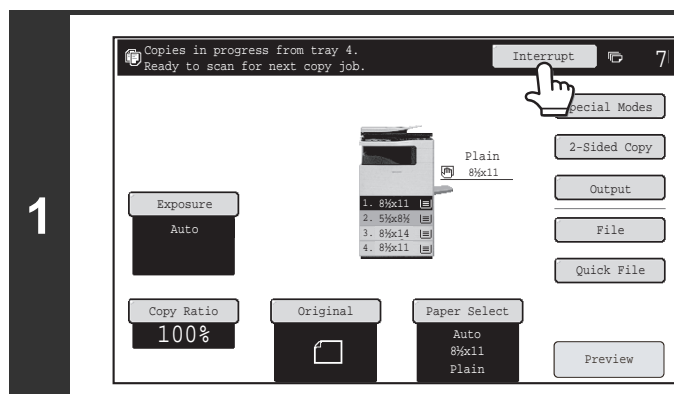

### Touch the [Interrupt] key.

The [Interrupt] key does not appear while an original is being scanned.

1

### Place the original.

Place the original face up in the document feeder tray, or face down on the document glass.

2

Place the original in the automatic document feeder.

➤ [PLACING ORIGINALS IN THE AUTOMATIC DOCUMENT FEEDER](#) (page 1-37)

After placing the original, specify the original size.

➤ [ORIGINAL SIZES](#) (page 2-29)

3

### Select copy settings and press the [START] key.

The interrupt copy job begins.

4

### When the interrupt copy job is completed, the interrupted job resumes.

➤ **To cancel scanning and copying...**



Press the [STOP] key (⏹).



- If user authentication is enabled, the login screen will appear when the [Interrupt] key is pressed. Enter your user name and password to log in. The number of copies made will be added to the count of the user that logged in.
- Depending on the settings of the job in progress, the [Interrupt] key may not appear.
- Depending on the settings of the job in progress, the [Reserve] key may appear instead of the [Interrupt] key. Unlike interrupt copy, reserve copy does not temporarily stop the job in progress. Instead, the reserve copy job begins when the job in progress is finished.
- Interrupt copy cannot be used in combination with the following special modes:  
Job Build, Card Shot, Original Count
- If the document glass is used for an interrupt copy job, 2-sided copying, sort copying, and staple sort copying cannot be selected. If any of these functions are necessary, use the automatic document feeder.

# CHECKING A PREVIEW IMAGE OF A COPY (Preview)

You can touch the [Preview] key so that it is highlighted in the base screen and then scan the original to check a preview image of the copy in the touch panel before printing the copy.

## 1 Place the original.

- Place the original face up in the document feeder tray, or face down on the document glass.
- Place the original in the automatic document feeder.

 [PLACING ORIGINALS IN THE AUTOMATIC DOCUMENT FEEDER](#) (page 1-37)

2

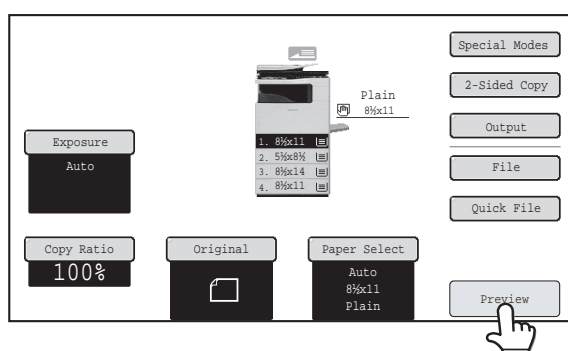

Touch the [Preview] key so that it is highlighted.

## 3 Select copy settings and press the [START] key.

- After the original is scanned, a preview image of the copy appears in the touch panel. The copy is not printed until the [Start Copy] key is touched in the preview screen.

4

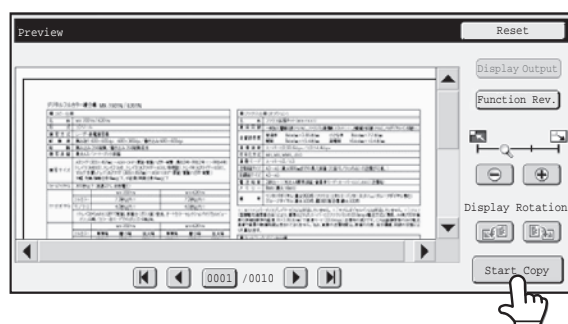



Check the preview image and then touch the [Start Copy] key.

Copy printing begins.

For details on the preview screen, see "[PREVIEW SCREEN](#)" (page 2-103).

 If you need to change the copy settings, touch the [Reset] key.

 **To cancel copying...**  
Press the [STOP] key (.

**To cancel the operation...**

Press the [CLEAR ALL] key (CA).

**System Settings (Administrator): Default Preview**

You can set the default state of the [Preview] key to always selected (highlighted). Enable this setting if you wish to check a preview image each time you make a copy.



# PREVIEW SCREEN

The preview screen is explained below.

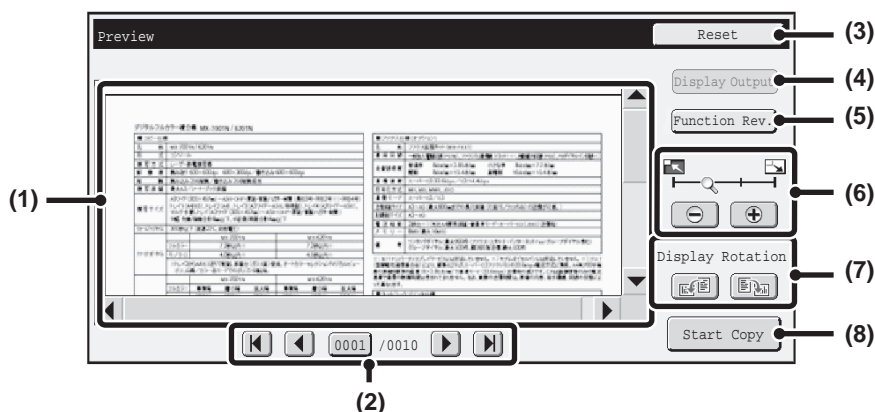

**(1) Preview image**

A preview image of the scanned original is displayed. If the image is cut off, use the scroll bars at the right and bottom of the screen to scroll the image. Touch a bar and slide it to scroll. (You can also touch the keys to scroll.)

**(2) Change page keys**

When there are multiple pages of images, use these keys to change pages.

- keys: Go to the first or the last page.
- keys: Go to the previous page or the next page.
- Page number display: This shows the total number of pages and the current page number. You can touch the current page number key and enter a number with the numeric keys to go to that page number.

**(3) [Reset] key**

Touch to change the copy settings after checking the preview image. After changing the settings, touch the [Preview Again] key to update the preview image with the new settings.

**(4) [Display Output] key**

Touch to show the selected modes and settings as icons. Functions that are displayed are as follows:

- 2-sided copying
- Pamphlet copy
- Staple function
- Stamp menu
- Transparency inserts

This key can only be touched when the entire preview image is displayed in the preview screen.

**(5) [Function Rev.] key**

Touch to check special mode items, 2-sided copying, and output settings.

**(6) Display zoom key**

Use this to set the zoom ratio of the displayed image. Changes from the left in the order "Full Page", "Twice", "4 Times", "8 Times". The setting applies to all pages in the file, not just the displayed page.

**(7) "Display Rotation" key**

This rotates the image right or left by 90 degrees. The rotation applies to all pages in the file, not just the displayed page.

**(8) [Start Copy] key**

Touch to start printing the copy.

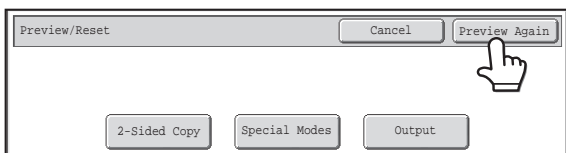



- A preview image is an image for display on the touch panel. It will differ from the actual print result.
- The preview image reflects certain copy settings and special mode settings. Settings that are reflected in the preview image are as follows:  
 Copy settings: ratio, paper size  
 Special modes: margin shift, edge erase, dual page copy, pamphlet copy, transparency film, multi shot, card shot, image edit menu, mixed size original, 8 Business Cards Layout
- Fine lines (such as borderlines printed by the multi shot function) may not appear correctly at some zoom ratios.

# JOB STATUS SCREEN

The job status screen is displayed when the [JOB STATUS] key on the operation panel is pressed. The job status screen shows the status of jobs by mode. When the [JOB STATUS] key is pressed, the job status screen of the mode that was being used before the key was pressed appears.

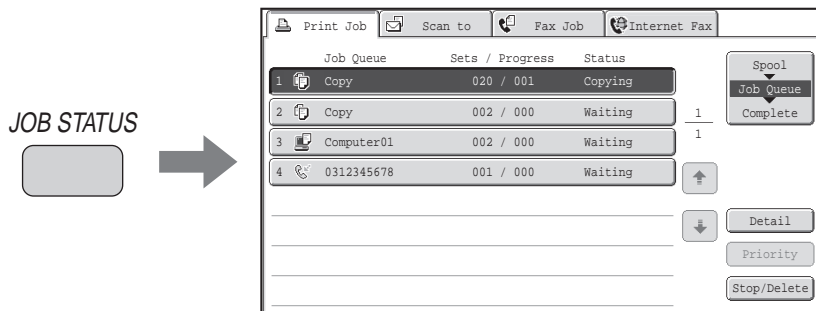
**Example: Pressing the key in copy mode**



 The job status display (A) is in the lower left corner of the touch panel. The job status display can be touched to display the job status screen. The first four jobs in the print queue (the job in progress and reserved jobs) can be checked in the job status display (B).

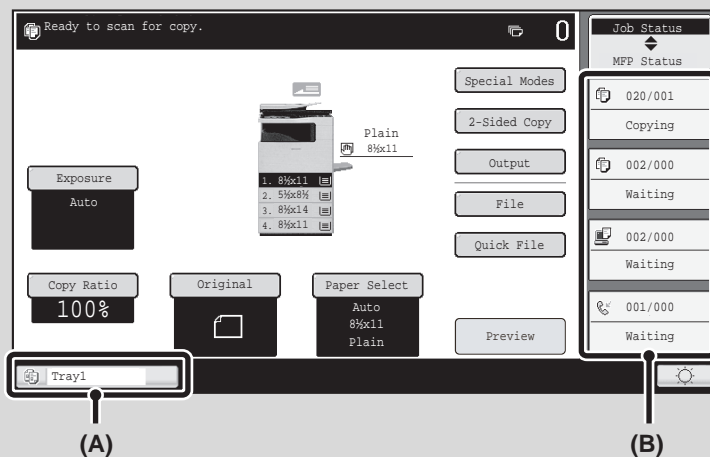

# JOB QUEUE SCREEN AND COMPLETED JOB SCREEN

The job status screen consists of the job queue screen that shows copy and print jobs waiting to be printed and the job currently in progress, the completed job screen that shows jobs that have been completed, and the spool screen that shows print jobs that have been spooled and encrypted PDF jobs that are waiting for a password to be entered. This section explains the job queue screen and the completed jobs screen, which are related to copy mode. The job status screen switches between the job queue screen and the completed jobs screen each time the job status screen selector key is touched.

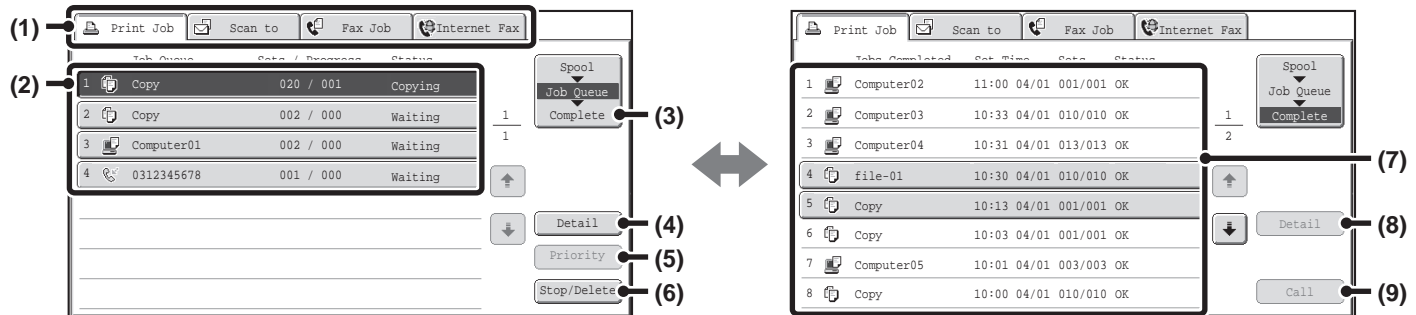

## (1) Mode select tabs

Use these tabs to select the mode that is shown in the job status screen.  
The status of copy jobs can be checked by touching the [Print Job] tab.

## (2) Job list (job queue screen)

Jobs waiting to be printed appear in the job queue as keys. The jobs are printed in order from the top of the queue. Each job key shows information on the job and the current status of the job.

## (3) Job status screen selector key

Touch this key to switch through the job queue screen, the completed jobs screen, and the spool screen.

## (4) [Detail] key (job queue screen)

Touch this key to display detailed information on a job.

## (5) [Priority] key

Touch this key to give priority to a selected job.

## (6) [Stop/Delete] key

Touch this key to stop or delete a selected job.

## (7) Job list (completed jobs screen)

This shows up to 99 completed jobs. The result (status) of each completed job is shown. Copy jobs that used the document filing function are indicated as keys.

## (8) [Detail] key (completed jobs screen)

When a job is shown as a key in the job list, the [Detail] key can be touched to show detailed information on the job.

## (9) [Call] key

Touch this key to retrieve and use a copy job stored using the document filing function.

## Job key display

Each job key shows the position of the job in the job queue and the current status of the job.

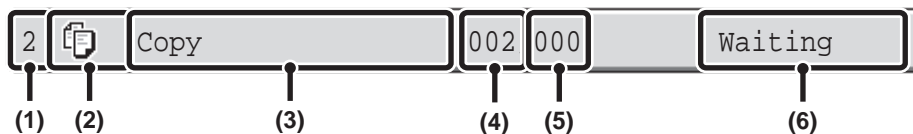

**(1) Indicates the number (position) of the job in the job queue.**

When the job currently being printed is finished, the job moves up one position in the job queue. This number does not appear in keys in the completed jobs screen.

**(2) Mode icon**

The  icon appears when the job is a copy job.

**(3) Job name**

"Copy" appears for a copy job. When user authentication is enabled, the name of the user that performed the job appears.

**(4) Number of copies (sets) entered**

This shows the number of copies (sets) specified.

**(5) Number of completed copies**

This shows the number of copies (sets) completed. "000" appears while the job is waiting in the job queue.

**(6) Status**

Shows the job status.

Message	Status
"Copying"	Copying is in progress.
"Waiting"	Scanning the original.
"Toner Empty"	The toner cartridge is out of toner. Replace the toner cartridge with a new cartridge.
"Paper Empty"	The paper used for the job has run out. Add paper or change to a different paper tray.
"Limit"	The copy page limit has been exceeded. Check with the administrator of the machine.
"Error"	An error occurred while the job was being executed. Clear the error condition.

# CANCELING A JOB THAT IS WAITING IN THE QUEUE

A copy job that is waiting to be printed can be canceled.

1

JOB STATUS



Press the [JOB STATUS] key.

2

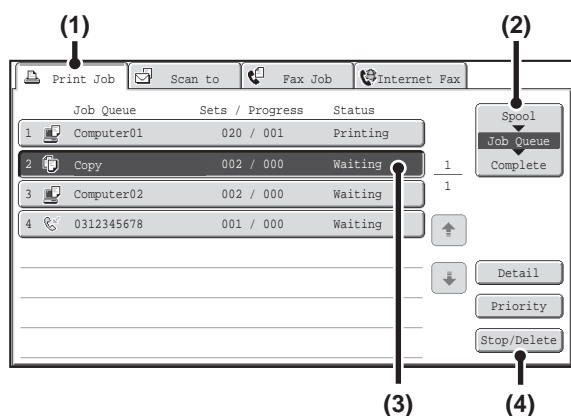

Cancel the job.

- (1) Touch the [Print Job] tab.
- (2) Change the print job status mode to [Job Queue].  
Touch this key to change modes. The selected mode will be highlighted.
- (3) Touch the key of the copy job that you wish to cancel.
- (4) Touch the [Stop/Delete] key.
- (5) A message appears to confirm the cancellation. Touch the [Yes] key.

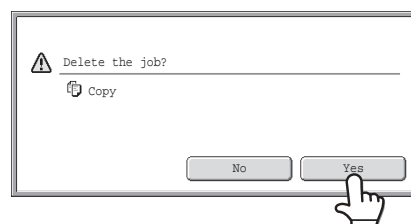

The selected job key is deleted and printing is canceled.



If the job in progress is a copy job, you can also press the [STOP] key (Ⓢ) to display the above screen. To cancel, touch the [Yes] key.



**If you do not want to cancel the selected print job...**  
Touch the [No] key in step (5).

# GIVING PRIORITY TO A JOB IN THE QUEUE

If a copy job is begun when there are already multiple jobs in the queue, the copy job will appear at the end of the queue. However, if you have an urgent copy job, you can give priority to the job and have it executed first.

1

JOB STATUS



Press the [JOB STATUS] key.

2

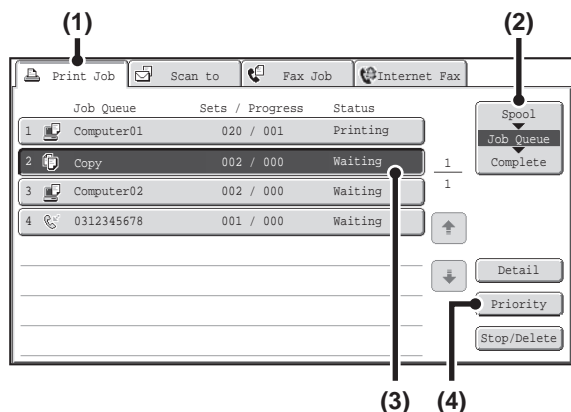

Give the desired job priority.

(1) Touch the [Print Job] tab.

(2) Change the print job status mode to [Job Queue].

Touch this key to change modes. The selected mode will be highlighted.

(3) Touch the key of the copy job to which you want to give priority.

(4) Touch the [Priority] key.

The job being printed stops and the job selected in (3) is printed.

# CHECKING INFORMATION ON A COPY JOB WAITING IN THE QUEUE

Detailed information can be displayed on a copy job waiting in the queue.

1

JOB STATUS

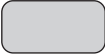

**Press the [JOB STATUS] key.**

2

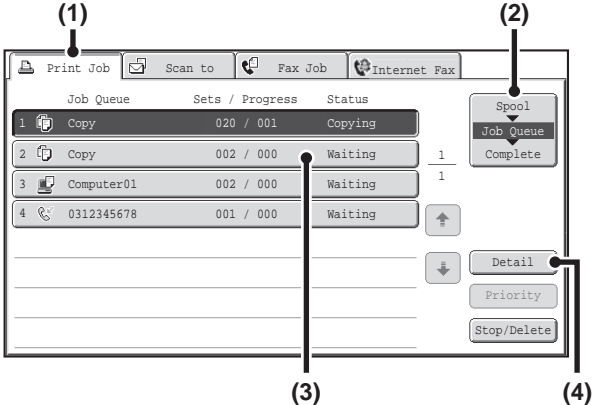

### Checking job details

- (1) Touch the [Print Job] tab.
- (2) Change the print job status mode to [Job Queue].  
Touch this key to change modes. The selected mode will be highlighted.
- (3) Touch the key of the job that you wish to check.
- (4) Touch the [Detail] key.  
The job check screen of the job selected in (3) appears.

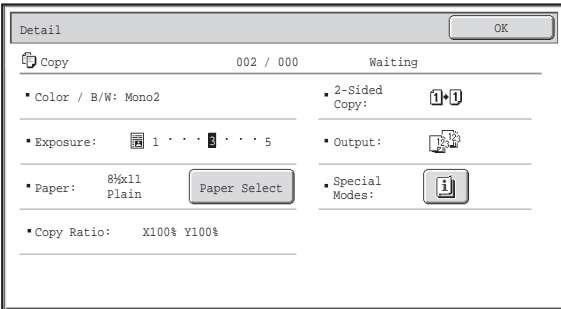



**[Paper Select] key**

If a copy job is stopped because the paper ran out, the [Paper Select] key can be pressed to change to a different paper tray.

When the [Paper Select] key is pressed, the paper tray selection screen appears.

**PAPER TRAYS** (page 2-11)

Touch the key of the tray that has the size of paper that you wish to use and then touch the [OK] key. The stopped copy job will resume.

# STORING COPY OPERATIONS (Job Programs)

A job program is a group of copy settings stored together. When copy settings are stored in a job program, the settings can be retrieved and used for a copy job by means of a simple operation.

For example, suppose 8-1/2" x 11" (A4) size CAD drawings are copied once a month for archive purposes using the following settings:

8-1/2" x 11" (A4) size CAD drawings

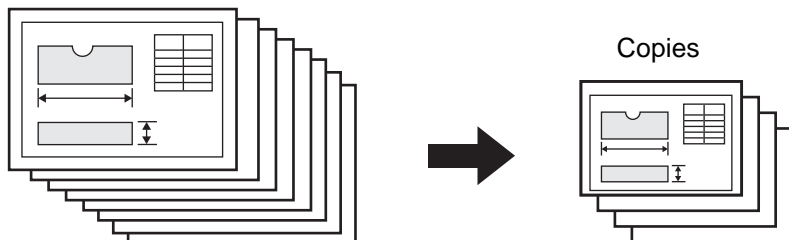

- (1) The 8-1/2" x 11" (A4) size CAD drawings are reduced to 5-1/2" x 8-1/2"(A5) size.
- (2) The drawings have fine lines that do not show clearly, and thus a dark exposure setting (level 4) is used.
- (3) To reduce paper use by half, 2-sided copying is used.

When a job program is not stored	When a job program is stored																
<p>8-1/2" x 11" (A4) to 5-1/2" x 8-1/2"(A5) reduction</p> <p style="text-align: center;">↓</p> <p style="text-align: center;">Change the exposure setting</p> <p style="text-align: center;">↓</p> <p style="text-align: center;">Select 2-sided copying</p> <p style="text-align: center;">↓</p> <p style="text-align: center;">Press the [START] key.</p>	<p style="text-align: center;">Ⓝ/P</p> <p style="text-align: center;">Press the [#P] key.</p> <p style="text-align: center;">↓</p> <div style="border: 1px solid black; padding: 5px; width: fit-content; margin: 0 auto;"> <p style="text-align: right; margin: 0;">Exit</p> <p>Job Programs</p> <p>Press program number.</p> <table style="width: 100%; border-collapse: collapse;"> <tr> <td style="text-align: center; border: 1px solid gray;">1</td> <td style="text-align: center; border: 1px solid gray;">2</td> <td style="text-align: center; border: 1px solid gray;">3</td> <td style="text-align: center; border: 1px solid gray;">1 4</td> </tr> <tr> <td style="text-align: center; border: 1px solid gray;">4</td> <td style="text-align: center; border: 1px solid gray;">5</td> <td style="text-align: center; border: 1px solid gray;">6</td> <td style="text-align: center; border: 1px solid gray;">↑</td> </tr> <tr> <td style="text-align: center; border: 1px solid gray;">7</td> <td style="text-align: center; border: 1px solid gray;">8</td> <td style="text-align: center; border: 1px solid gray;">9</td> <td style="text-align: center; border: 1px solid gray;">↓</td> </tr> <tr> <td style="text-align: center; border: 1px solid gray;">10</td> <td style="text-align: center; border: 1px solid gray;">11</td> <td style="text-align: center; border: 1px solid gray;">12</td> <td></td> </tr> </table> <p style="text-align: center; margin-top: 5px;">Recall      Store/Delete</p> </div> <p style="text-align: center;">Touch the stored program key.</p> <p style="text-align: center;">↓</p> <p style="text-align: center;">Press the [START] key.</p>	1	2	3	1 4	4	5	6	↑	7	8	9	↓	10	11	12	
1	2	3	1 4														
4	5	6	↑														
7	8	9	↓														
10	11	12															
<p>Considerable time is required to copy the drawings each month because the above settings must be selected. In addition, mistakes are occasionally made when selecting the settings, so some copies must be redone.</p>	<p>The settings are stored in a job program, so they can be selected by the touch of a key. This is simple and takes no time. In addition, the settings are all stored so there are no chances for mistakes, and thus no need to redo copies due to setting mistakes.</p>																

- Up to 48 job programs can be stored. The job programs are retained even if an interruption occurs in the power supply.
- Job programs can also be stored in the Web pages. Click [Job program] and then [Copy] in the Web page menu to store a job program.



# STORING (EDITING/DELETING) A JOB PROGRAM

The procedures for storing copy settings in a job program and deleting a job program are explained below.

1

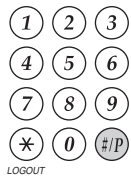

LOGOUT

**Press the [# / P] key (  ).**

2

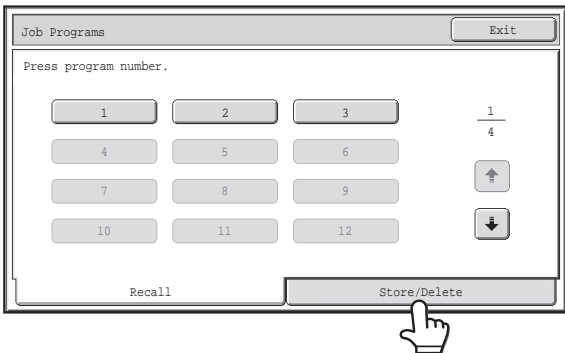

**Touch the [Store/Delete] tab.**

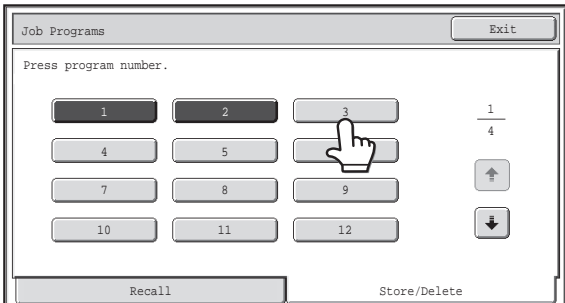

**Touch a numeric key.**

Numeric keys in which job programs are already stored are highlighted.

- To store a job program, touch a numeric key that is not highlighted.
- To edit or delete a job program, touch the key in which the job program is stored (highlighted key).

3



**Editing or deleting a job program...**

When a highlighted numeric key is touched, the following screen appears.

The [Store] key can be touched to delete the stored settings and store new settings. Go to the next step.

When the [Delete] key is touched, the stored settings are deleted. After the deletion is finished, touch the [Exit] key to return to the base screen.

A job program has been already stored in this location.

Cancel
Delete
Store

When "Disabling Deletion of Job Programs" is enabled in the system settings, a stored job program cannot be edited or deleted.

4

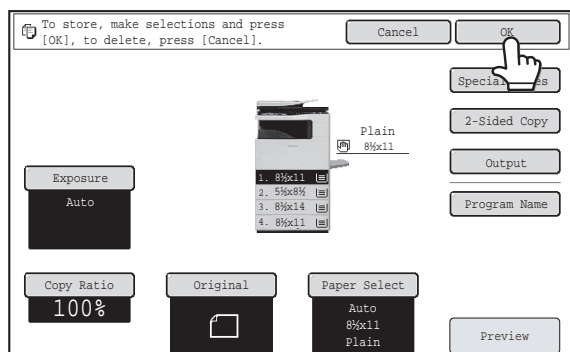

**Select the copy settings that you wish to store in the job program and touch the [OK] key.**

To assign a name to the program, touch the [Program Name] key. A text entry screen will appear.

Up to 10 characters can be entered for the name.

When you have finished, touch the [OK] key.

You will return to the base screen with the stored information reflected in the screen.



The number of copies cannot be stored.

# CHAPTER 3

# PRINTER

This chapter provides detailed explanations of the procedures for using the printer function.

## PRINTER FUNCTION OF THE MACHINE..... 3-3

### PRINTING FROM WINDOWS

#### BASIC PRINTING PROCEDURE..... 3-4

- SELECTING THE PAPER ..... 3-6
- PRINTING ON ENVELOPES ..... 3-7

#### PRINTING WHEN THE USER AUTHENTICATION FUNCTION IS ENABLED .... 3-8

#### VIEWING PRINTER DRIVER HELP..... 3-11

#### SAVING FREQUENTLY USED PRINT SETTINGS ..... 3-12

- SAVING SETTINGS AT THE TIME OF PRINTING ..... 3-12
- USING SAVED SETTINGS ..... 3-14

#### CHANGING THE PRINTER DRIVER DEFAULT SETTINGS ..... 3-15

### PRINTING FROM A MACINTOSH

#### BASIC PRINTING PROCEDURE..... 3-17

- SELECTING PAPER SETTINGS..... 3-17
- PRINTING ..... 3-18
- SELECTING THE PAPER ..... 3-20
- PRINTING ON ENVELOPES ..... 3-21

#### PRINTING WHEN THE USER AUTHENTICATION FUNCTION IS ENABLED ... 3-22

### FREQUENTLY USED FUNCTIONS

#### SELECTING A PRINT MODE SETTING ..... 3-24

#### TWO-SIDED PRINTING ..... 3-26

#### FITTING THE PRINT IMAGE TO THE PAPER ... 3-28

#### PRINTING MULTIPLE PAGES ON ONE PAGE ..... 3-29

#### STAPLING OUTPUT ..... 3-31

## CONVENIENT PRINTING FUNCTIONS

### CONVENIENT FUNCTIONS FOR CREATING PAMPHLETS AND POSTERS..... 3-34

- CREATING A PAMPHLET (Pamphlet)..... 3-34
- INCREASING THE MARGIN (Margin Shift) ... 3-36
- CREATING A LARGE POSTER (Poster Printing) ..... 3-37

### FUNCTIONS TO ADJUST THE SIZE AND ORIENTATION OF THE IMAGE..... 3-38

- ROTATING THE PRINT IMAGE 180 DEGREES (Rotate 180 degrees)..... 3-38
- ENLARGING/REDUCING THE PRINT IMAGE (Zoom/XY-Zoom) ..... 3-39
- ADJUSTING LINE WIDTHS WHEN PRINTING (Line Width Settings) ..... 3-40
- REVERSING THE IMAGE (Mirror Image) .... 3-41

### IMAGE ADJUSTMENT FUNCTION ..... 3-42

- ADJUSTING THE BRIGHTNESS AND CONTRAST OF THE IMAGE (Image Adjustment) ..... 3-42
- PRINTING FAINT TEXT AND LINES IN BLACK (Text To Black/Vector To Black) ..... 3-43

### FUNCTIONS THAT COMBINE TEXT AND IMAGES ..... 3-44

- ADDING A WATERMARK TO PRINTED PAGES (Watermark) ..... 3-44
- PRINTING AN IMAGE OVER THE PRINT DATA (Image Stamp) ..... 3-45
- CREATING OVERLAYS FOR PRINT DATA (Overlays) ..... 3-46



**PRINT FUNCTIONS FOR SPECIAL PURPOSES . . . . . 3-47**

- PRINTING SPECIFIED PAGES ON DIFFERENT PAPER (Different Paper). . . . . 3-47
- ADDING INSERTS WHEN PRINTING ON TRANSPARENCY FILM (Transparency Inserts) . . . . . 3-49
- PRINTING A CARBON COPY (Carbon Copy) . . . . . 3-50
- TWO-SIDED PRINTING WITH SPECIFIC PAGES PRINTED ON THE FRONT SIDE (Chapter Inserts). . . . . 3-51

**CONVENIENT PRINTER FUNCTIONS . . . . . 3-52**

- SAVING AND USING PRINT FILES (Retention/Document Filing). . . . . 3-52

**PRINTING WITHOUT THE PRINTER DRIVER**

**DIRECTLY PRINTING FROM THE MACHINE. . . . . 3-55**

- DIRECTLY PRINTING A FILE ON AN FTP SERVER. . . . . 3-56
- DIRECTLY PRINTING A FILE IN USB MEMORY . . . . . 3-57
- DIRECTLY PRINTING A FILE IN A NETWORK FOLDER . . . . . 3-59

**DIRECTLY PRINTING FROM A COMPUTER . . . . . 3-62**

- SUBMIT PRINT JOB . . . . . 3-62
- FTP PRINT . . . . . 3-62
- E-MAIL PRINT . . . . . 3-63

**CHECKING THE PRINT STATUS**

**JOB STATUS SCREEN . . . . . 3-64**

- SPOOL SCREEN/JOB QUEUE SCREEN/COMPLETED JOB SCREEN . . . . . 3-65

**PRINTING AN ENCRYPTED PDF FILE. . . . . 3-67**

**GIVING A PRINT JOB PRIORITY/CANCELING A PRINT JOB. . . . . 3-68**

- GIVING A PRINT JOB PRIORITY . . . . . 3-68
- CANCELING A PRINT JOB . . . . . 3-69

**CHANGING TO ANOTHER PAPER SIZE AND PRINTING WHEN PAPER RUNS OUT . . . . . 3-70**

**APPENDIX**

**PRINTER DRIVER SPECIFICATION LIST . . . . . 3-71**

**PRINTER SPECIFICATIONS . . . . . 3-73**

# PRINTER FUNCTION OF THE MACHINE

The machine is equipped standard with a printing function. To enable printing from your computer, a printer driver must be installed.

See the table below to determine which printer driver to use in your environment.

Environment	Printer driver type	Remarks
Windows	<b>PCL6, PCL5e*</b> The machine supports the Hewlett-Packard PCL6 and PCL5e printer control languages. It is recommended that you use the PCL6 printer driver. If you have a problem printing from older software using the PCL6 printer driver, use the PCL5e printer driver.	Can be used in the standard machine configuration.
	<b>PS</b> This printer driver supports the PostScript 3 page description language developed by Adobe Systems Incorporated, and enables the machine to be used as a PostScript 3 compatible printer. (A PPD file is available if it is desired to use the Windows standard PS printer driver.)	
Macintosh		

\* The PCL5e printer driver is not available in some countries.

## Installing the printer driver in a Windows environment

To install the printer driver and configure settings in a Windows environment, see "[SETUP IN A WINDOWS ENVIRONMENT](#)" (page 1-80) in "1. BEFORE USING THE MACHINE".

 The explanations in this manual of printing in a Windows environment generally use the screens of the PCL6 printer driver. The printer driver screens may differ slightly depending on the printer driver that you are using.

## Installing the printer driver in a Macintosh environment

To install the printer driver and configure settings in a Macintosh environment, see "[SETUP IN A MACINTOSH ENVIRONMENT](#)" (page 1-107) in "1. BEFORE USING THE MACHINE".

 In a Macintosh environment, the machine can only be used as a printer if it is connected to your network.

# PRINTING FROM WINDOWS

## BASIC PRINTING PROCEDURE

The following example explains how to print a document from "WordPad", which is a standard accessory program in Windows.

1

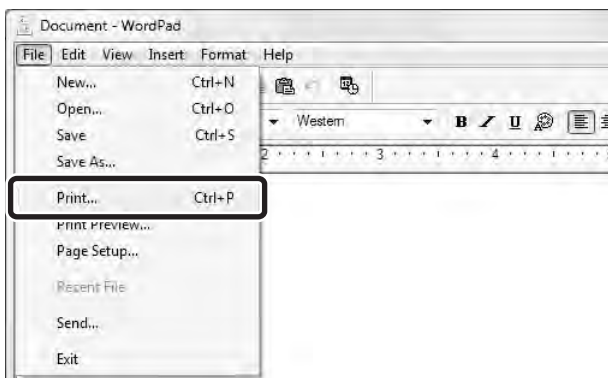

Select [Print] from the [File] menu of WordPad.

If you are using Windows 7, click the  button.



The menu used to execute printing may vary depending on the software application.

2

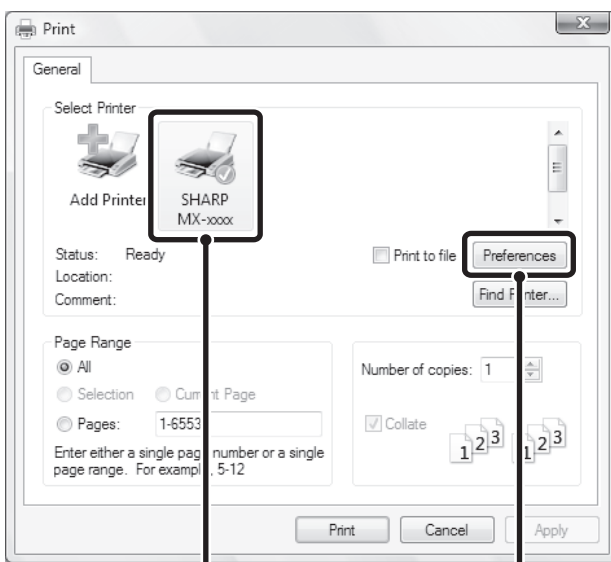

Open the printer driver properties window.

- (1) Select the printer driver of the machine.
  - If the printer drivers appear as icons, click the icon of the printer driver to be used.
  - If the printer drivers appear as a list, select the name of the printer driver to be used from the list.
- (2) Click the [Preferences] button.

If you are using Windows 2000, the [Preferences] button does not appear. Click a tab on the "Print" dialog box to adjust the settings on that tab.



The button that is used to open the printer driver properties window (usually [Properties] or [Printing Preferences]) may vary depending on the software application.

3

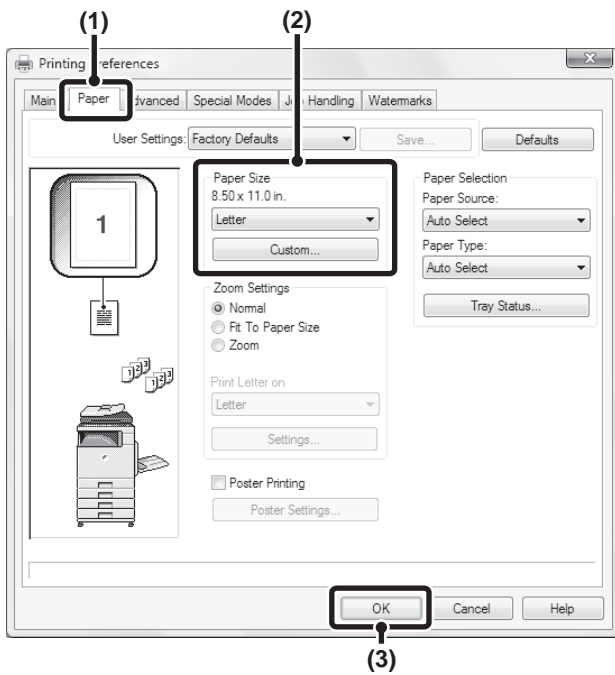

**Select print settings.**

(1) Click the [Paper] tab.

(2) Select the paper size.

To select settings on other tabs, click the desired tab and then select the settings.

(3) Click the [OK] button.



- Make sure the paper size is the same as the paper size set in the software application.
- Up to eight custom paper sizes can be stored. Storing a custom paper size makes it easy to specify that size each time you need to use it.  
To store a paper size, select [Custom Paper] or one of [User1] to [User7] from the pull-down menu and click the [Custom] button.

4

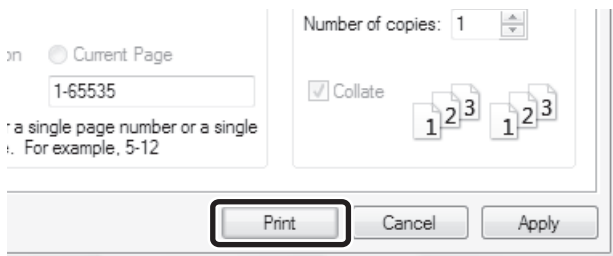

**Click the [Print] button.**

Printing begins.

# SELECTING THE PAPER

This section explains how to configure the "Paper Selection" setting on the [Paper] tab of the printer driver properties window.

Before printing, check the paper sizes, paper types, and paper remaining in the machine's trays. To view the most recent tray information, click the [Tray Status] button.

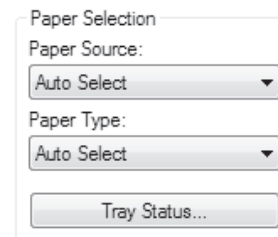

- **When [Auto Select] is selected in "Paper Source"**

The tray that has the size and type of paper selected in "Paper Size" and "Paper Type" on the [Paper] tab is automatically selected.

- **When other than [Auto Select] is selected in "Paper Source"**

The specified tray is used for printing regardless of the "Paper Size" setting.

- **When [Bypass Tray] is selected**

The "Paper Type" must also be selected. Check the bypass tray and make sure that the desired type of paper is loaded, and then select the appropriate "Paper Type" setting.



- Special media such as envelopes can also be placed in the bypass tray. For the procedure for loading paper and other media in the bypass tray, see "[LOADING PAPER IN THE BYPASS TRAY](#)" (page 1-33) in "1. BEFORE USING THE MACHINE".
- When "Enable Detected Paper Size in Bypass Tray" (disabled by factory default) or "Enable Selected Paper Type in Bypass Tray" (enabled by factory default) is enabled in the system settings (administrator), printing will not take place if the paper size or paper type specified in the printer driver is different from the paper size or paper type specified in the settings of the bypass tray.

- **When [Auto Select] is selected in "Paper Type"**

A tray with plain paper or recycled paper of the size specified in "Paper Size" is automatically selected. (The factory default setting is plain paper only.)

- **When other than [Auto Select] is selected in "Paper Type"**

A tray with the specified type of paper and the size specified in "Paper Size" is used for printing.



**System Settings (Administrator): Exclude Bypass-Tray from Auto Paper Select**

When [Auto Select] is selected in "Paper Selection", specify whether or not the paper in the bypass tray will be excluded from the paper that can be selected. This setting is disabled by factory default, and thus paper in the bypass tray is included in the paper that can be automatically selected. If special media are frequently loaded in the bypass tray, it is recommended that this setting be enabled.



# PRINTING ON ENVELOPES

The bypass tray can be used to print on special media such as envelopes. The procedure for printing on an envelope from the printer driver properties screen is described below.

For the types of paper that can be used in the bypass tray, see "[IMPORTANT POINTS ABOUT PAPER](#)" (page 1-27) in "BEFORE USING THE MACHINE". For the procedure for loading paper in the bypass tray, see "[LOADING PAPER IN THE BYPASS TRAY](#)" (page 1-33) in "1. BEFORE USING THE MACHINE".

Select the envelope size in the appropriate settings of the application ("Page Settings" in many applications) and then perform the following steps.

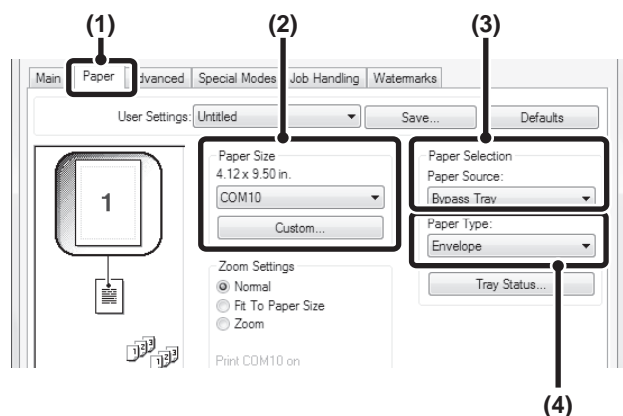

- (1) Click the [Paper] tab.
- (2) Select the envelope size from the "Paper Size" menu.
- (3) Select [Bypass Tray] from the "Paper Source" menu of "Paper Selection".
- (4) Select [Envelope] from the "Paper Type" menu.

Set the paper type of the bypass tray to [Envelope] and make sure the envelope is loaded in the bypass tray.

- It is recommended that you do a test print to check the print result before using an envelope.
- In the case of media that can only be loaded in a certain orientation such as an envelope, you can rotate the image 180 degrees if needed. For more information, see "[ROTATING THE PRINT IMAGE 180 DEGREES \(Rotate 180 degrees\)](#)" (page 3-38).
- For more information on "Paper Selection", see "[SELECTING THE PAPER](#)" (page 3-6).

# PRINTING WHEN THE USER AUTHENTICATION FUNCTION IS ENABLED

When the user authentication function is enabled in the machine's system settings (administrator), your user information (login name, password, etc.) must be entered in the printer driver properties window before you can print. The information that must be entered varies depending on the authentication method being used, so check with the administrator of the machine before printing.

1

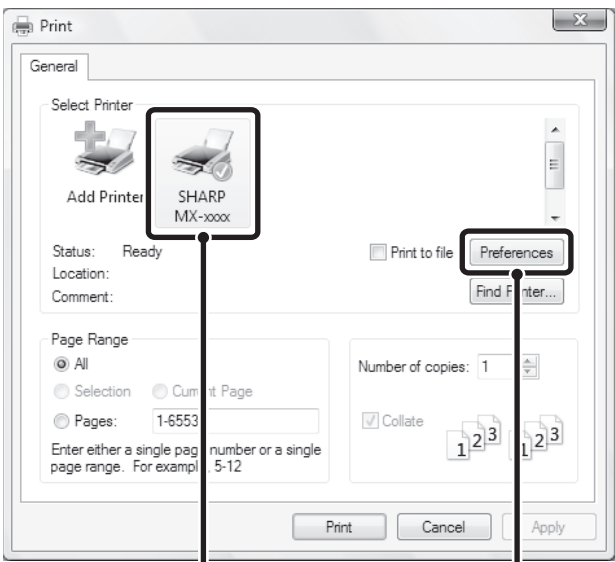

The screenshot shows a 'Print' dialog box with a 'General' tab. A printer icon labeled 'SHARP MX-xxxx' is selected and highlighted with a red box and a line pointing to the number '(1)'. A 'Preferences' button is also highlighted with a red box and a line pointing to the number '(2)'. The dialog includes fields for 'Status', 'Location', 'Comment', 'Page Range', 'Number of copies', and 'Collate' options. At the bottom are 'Print', 'Cancel', and 'Apply' buttons.

**Open the printer driver properties window from the print window of the software application.**

- (1) Select the printer driver of the machine.
- (2) Click the [Preferences] button.

---



The button that is used to open the printer driver properties window (usually [Properties] or [Printing Preferences]) may vary depending on the software application.

2

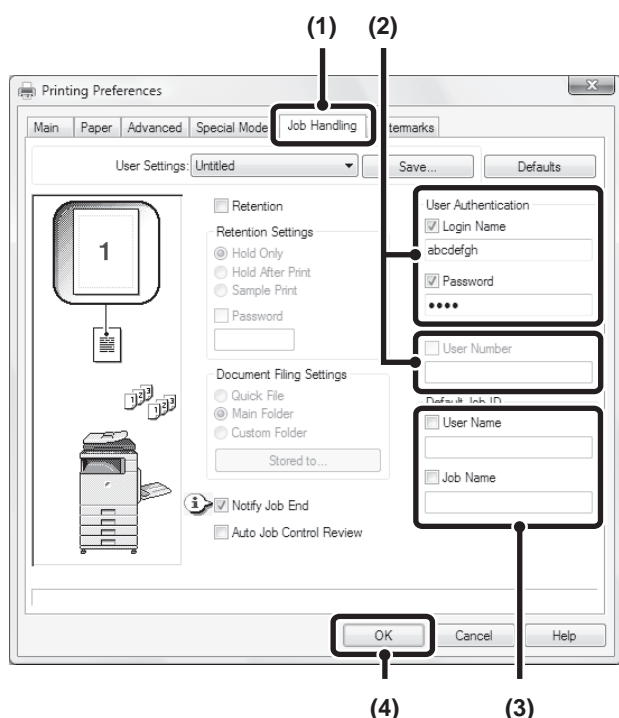

## Enter your login name and password.

(1) Click the [Job Handling] tab.

(2) Enter your user information.

- **When authentication is by login name/password**  
Select the [Login Name] and [Password] checkboxes so that checkmarks  appear, and enter your login name and password. Enter 1 to 32 characters for the password.
- **When authentication is by user number**  
Click the [User Number] checkbox  and enter a user number (5 to 8 digits).



When [User Authentication] has been checked on [Printing Policy] in the [Configuration] tab, you cannot enter the user information. Enter the user information in the dialog box whenever you print.

(3) Enter the user name and job name as necessary.

- **User Name**  
Click the [User Name] checkbox  and enter your user name (maximum of 32 characters). Your entered user name will appear at the top of the operation panel. If you do not enter a user name, your computer login name will appear.
- **Job Name**  
Click the [Job Name] checkbox  and enter a job name (maximum of 30 characters). The entered job name will appear at the top of the operation panel as a file name. If you do not enter a job name, the file name set in the software application will appear.

(4) Click the [OK] button.



To have a confirmation window appear before printing starts, select the [Auto Job Control Review] checkbox so that a checkmark  appears.

3

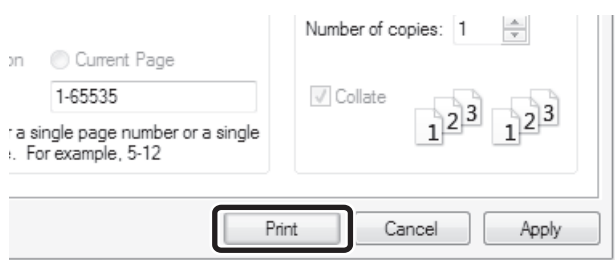

## Start printing.



- Even when user authentication is enabled in the system settings (administrator), normally printing is possible without entering user information. The number of pages printed is added to the "Other User" count. In this case, other print functions may be restricted. For more information, ask your administrator.
- The machine's user authentication function cannot be used when the PPD file\* is installed and the Windows standard PS printer driver is used. For this reason, printing will not be possible if printing by invalid users is prohibited in the system settings (administrator).

\* The PPD file enables the machine to print using the standard PS printer driver of the operating system.

**System Settings (Administrator): Disabling of Printing by Invalid User**

This is used to prohibit printing of print jobs by users whose user information is not stored in the machine. When this function is enabled, printing is not allowed when user information is not entered or incorrect information is entered.

# VIEWING PRINTER DRIVER HELP

When selecting settings in the printer driver, you can display Help to view explanations of the settings.

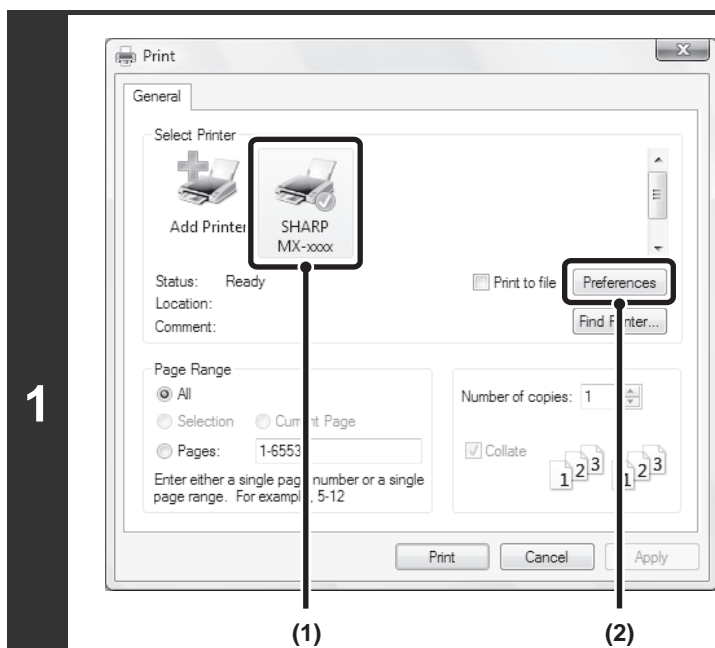

**Open the printer driver properties window from the print window of the software application.**

- (1) Select the printer driver of the machine.
- (2) Click the [Preferences] button.



The button that is used to open the printer driver properties window (usually [Properties] or [Printing Preferences]) may vary depending on the software application.

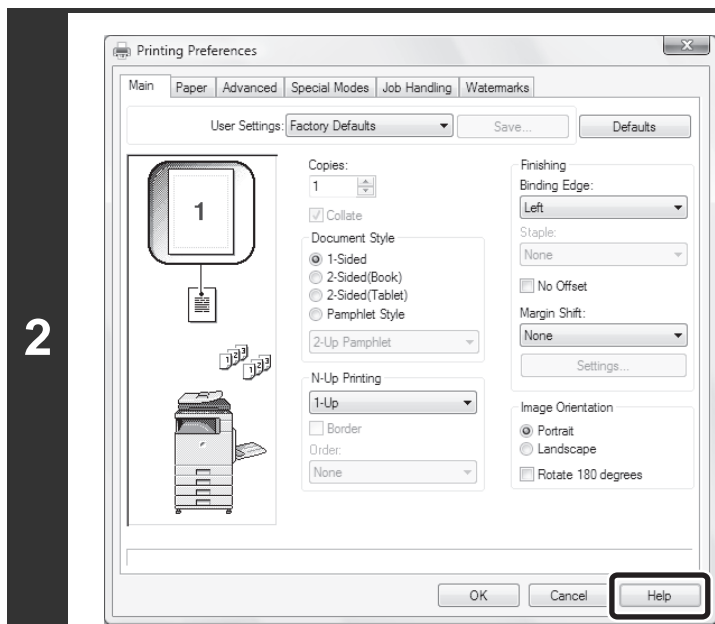

**Click the [Help] button.**

The Help window will open to let you view explanations of the settings on the tab.

To view Help for settings in a dialog box, click the underlined text at the top of the Help window.

## Pop-up help

Help can be displayed for a setting by clicking the setting and pressing the [F1] key.

\* To view Help for a setting in Windows 2000/XP/Server 2003, click the  button in the upper right-hand corner of the printer driver properties window and then click the setting.

You can also view the same Help by right-clicking the setting and clicking the [Help] box that appears.

## Information icon

Some restrictions exist on the combinations of settings that can be selected in the printer driver properties window.

When a restriction exists on a selected setting, an information icon () will appear next to the setting. Click the icon to view an explanation of the restriction.

# SAVING FREQUENTLY USED PRINT SETTINGS

Settings configured on each of the tabs at the time of printing can be saved as user settings. Saving frequently used settings or complex settings under an assigned name makes it easy to select those settings the next time you need to use them.

## SAVING SETTINGS AT THE TIME OF PRINTING

Settings can be saved from any tab of the printer driver properties window. Settings configured on each tab are listed at the time of saving, allowing you to check the settings as you save them.

1

**Open the printer driver properties window from the print window of the software application.**

- (1) Select the printer driver of the machine.
- (2) Click the [Preferences] button.

---

✎

The button that is used to open the printer driver properties window (usually [Properties] or [Printing Preferences]) may vary depending on the software application.

2

**Save the print settings.**

- (1) Configure print settings on each tab.
- (2) Click the [Save] button.

3

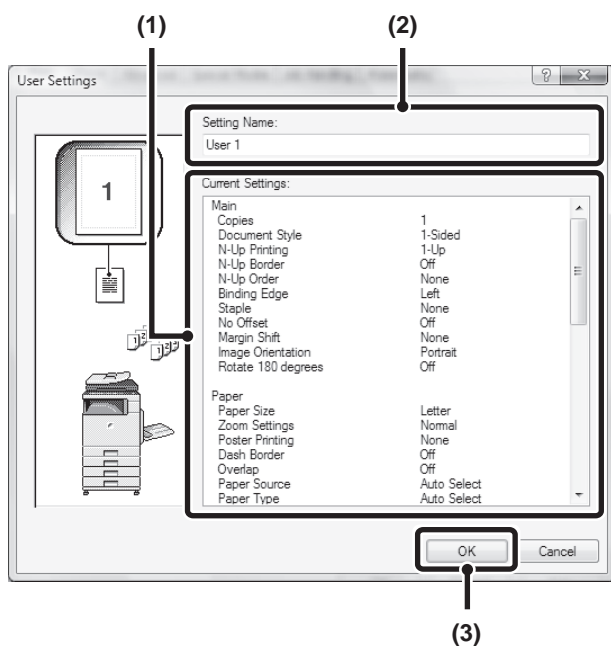

**Check and save the settings.**

- (1) Check the displayed settings.
- (2) Enter a name for the settings (maximum of 20 characters).
- (3) Click the [OK] button.

4

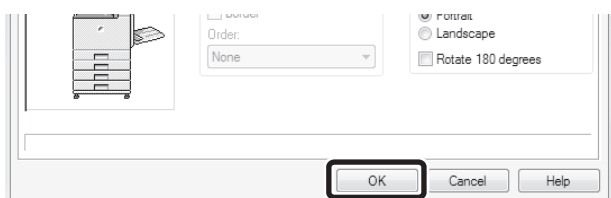

**Click the [OK] button.**

5

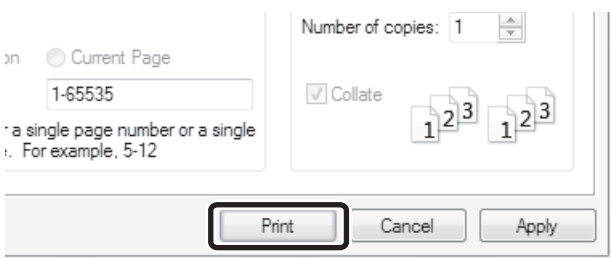

**Start printing.**



- Up to 30 sets of user settings can be saved.
- The following items cannot be saved in user settings.
  - A watermark that you created
  - Paper insertion settings
  - Overlay file
  - The login name, password, user name, and job name entered in the [Job Handling] tab

# USING SAVED SETTINGS

1

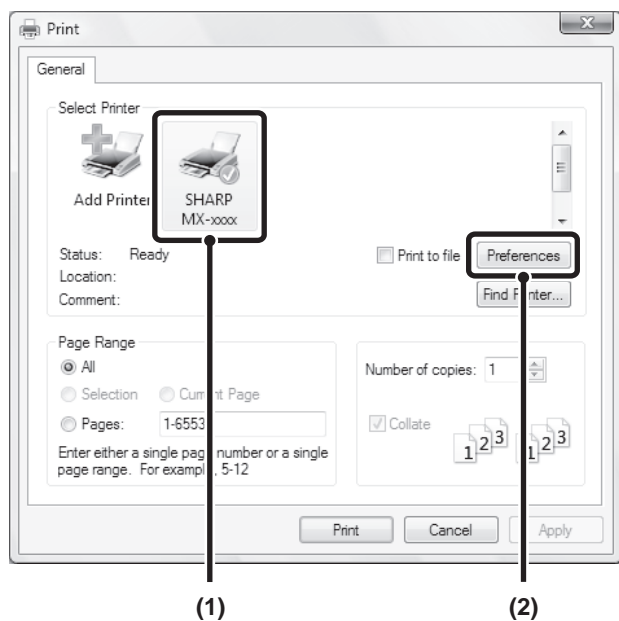

Open the printer driver properties window from the print window of the software application.

- (1) Select the printer driver of the machine.
- (2) Click the [Preferences] button.

 The button that is used to open the printer driver properties window (usually [Properties] or [Printing Preferences]) may vary depending on the software application.

2

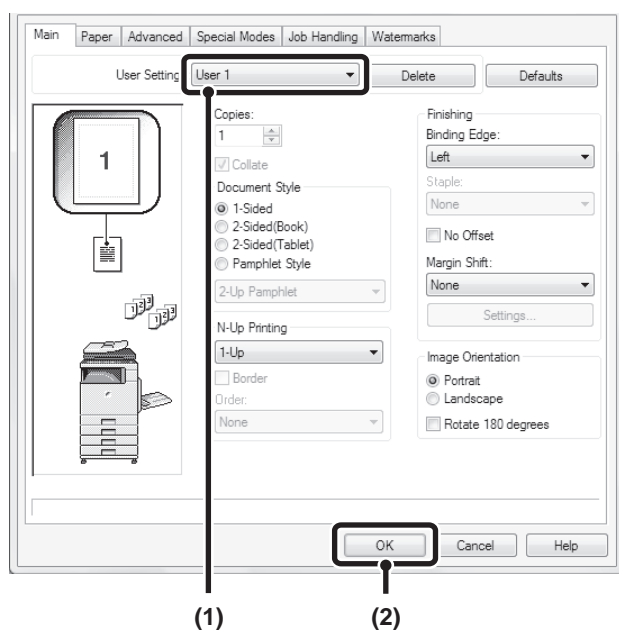

Select the print settings.

- (1) Select the user settings that you wish to use.
- (2) Click the [OK] button.

3



Start printing.

## Deleting saved settings

Select the user settings that you want to delete in (1) of step 2 above, and click the [Delete] button.



# CHANGING THE PRINTER DRIVER DEFAULT SETTINGS

The default settings of the printer driver can be changed using the procedure below. The settings selected using this procedure are saved and become the default settings when printing from a software application. (Settings selected in the printer driver properties window when printing from an application remain in effect only while the application is in use.)

1

## Click the [Start] button (⊞) and select [Control Panel] and then [Printer].

- In Windows 7, click the [start] button and then click [Devices and Printers].
- In Windows XP/Server 2003, click the [start] button and then click [Printers and Faxes].
- In Windows 2000, click the [Start] button, point to [Settings], and then select [Printers].



In Windows XP, if [Printers and Faxes] does not appear in the [start] menu, select [Control Panel], select [Printers and Other Hardware], and then select [Printers and Faxes].

2

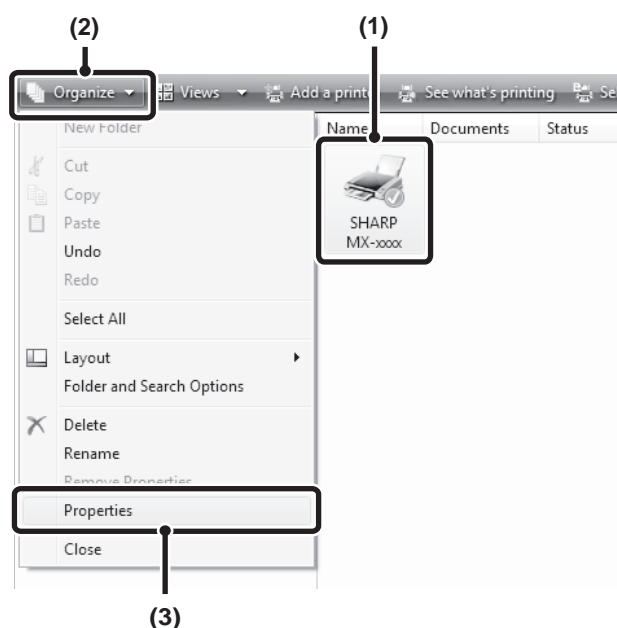

## Open the printer properties window.

### (1) Click the icon of the printer driver of the machine.

In Windows 7, right-click the icon of the printer driver of the machine. Go to step (3).

### (2) Click the [Organize] menu.

In Windows 2000/XP/Server 2003, click the [File] menu.

### (3) Select [Properties].

In windows 7, click the [Printer properties] menu.

3

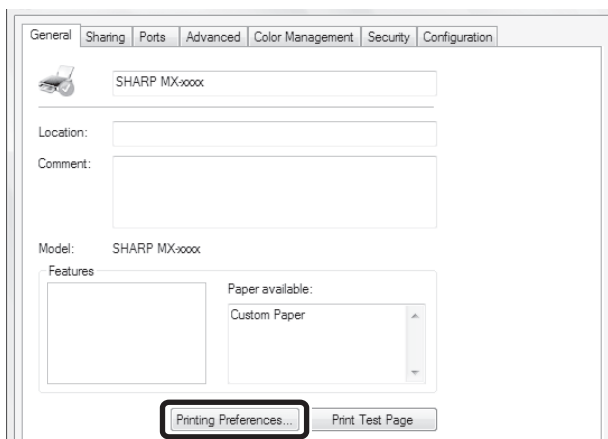

## Click the [Printing Preferences] button on the [General] tab.

In Windows 7, click the [Preferences] button on the [General] tab.

4

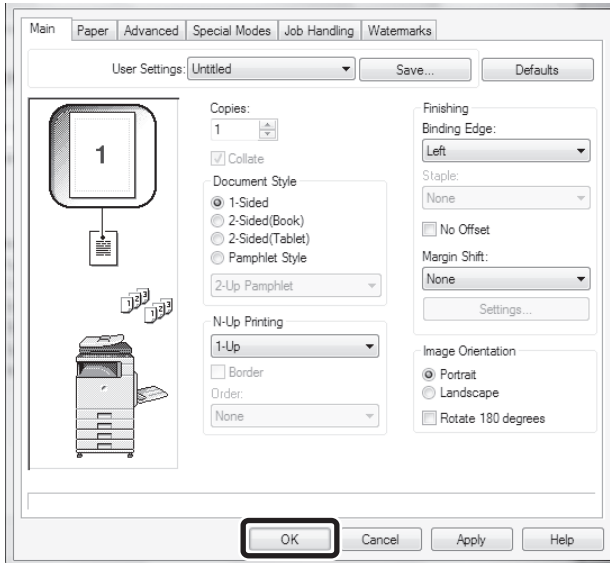

**Configure the settings and click the [OK] button.**

For explanations of the settings, see printer driver Help.

# PRINTING FROM A MACINTOSH

## BASIC PRINTING PROCEDURE

The following example explains how to print a document from the standard accessory program "TextEdit" in Mac OS X ("SimpleText" in Mac OS 9).

### SELECTING PAPER SETTINGS

Select paper settings in the printer driver before selecting the print command.

1

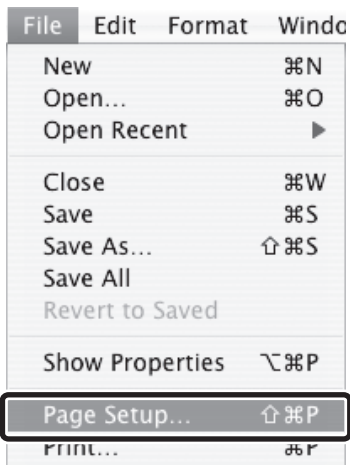

The screenshot shows the 'File' menu of a text editor. The menu items are: New (⌘N), Open... (⌘O), Open Recent (with a submenu arrow), Close (⌘W), Save (⌘S), Save As... (⇧⌘S), Save All, Revert to Saved, Show Properties (⇧⌘P), **Page Setup... (⇧⌘P)**, and Print... (⌘P). The 'Page Setup...' option is highlighted with a dark grey background.

**Select [Page Setup] from the [File] menu of TextEdit.**

In Mac OS 9, select [Page Setup] from the [File] menu of SimpleText.

2

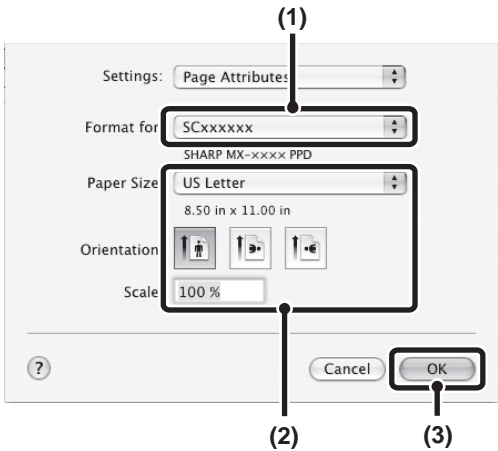

The screenshot shows the 'Page Attributes' dialog box. Callout (1) points to the 'Settings' dropdown menu. Callout (2) points to the 'Format for' dropdown menu, which shows 'SCxxxxxx' and 'SHARP MX-xxxx PPD'. Callout (3) points to the 'OK' button. Other visible options include 'Paper Size' (US Letter, 8.50 in x 11.00 in), 'Orientation' (Portrait, Landscape, and a third icon), and 'Scale' (100%).

**Select paper settings.**

- (1) **Make sure that the correct printer is selected.**
- (2) **Select paper settings.**  
The paper size, paper orientation, and enlarge/reduce can be selected.
- (3) **Click the [OK] button.**

 The machine name that appears in the "Format for" menu is normally [SCxxxxxx]. ("xxxxxx" is a sequence of characters that varies depending on your machine model.)

# PRINTING

1

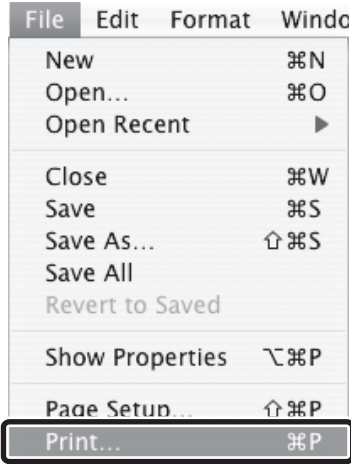

### Select [Print] from the [File] menu of TextEdit.

In Mac OS 9, select [Print] from the [File] menu of SimpleText.



The menu used to execute printing may vary depending on the software application.

2

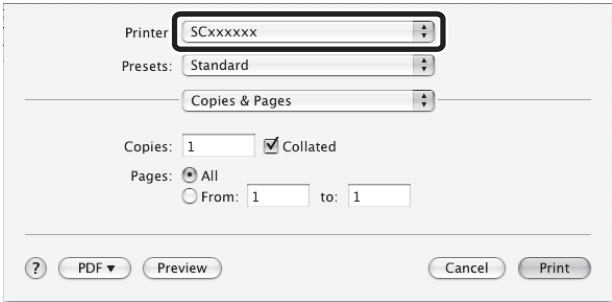

### Make sure that the correct printer is selected.



The machine name that appears in the "Printer" menu is normally [SCxxxxxx]. ("xxxxxx" is a sequence of characters that varies depending on the machine model.)

3

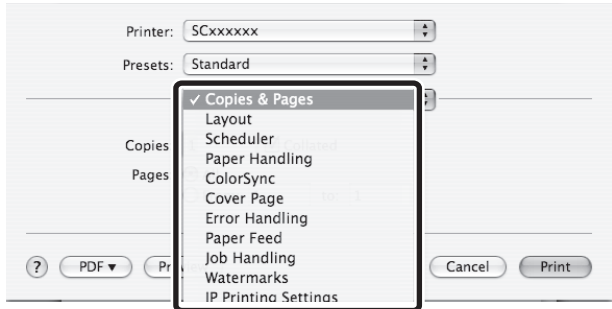

### Select print settings.

- In Mac OS X, click [v] next to [Copies & Pages] and select the settings that you wish to configure from the pull-down menu. The corresponding setting screen will appear. If the settings do not appear in Mac OS X v10.5 to 10.5.8 and v10.6 to 10.6.2, click [v] next to the printer name.
- In Mac OS 9, click [v] next to [General] and select the settings that you wish to configure from the pull-down menu. The corresponding setting screen will appear.

4

Printer: SCxxxxxx  
Presets: Standard  
Copies & Pages  
Copies: 1  Collated  
Pages:  All  
 From: 1 to: 1  
Buttons: ? PDF Preview Cancel **Print**

**Click the [Print] button.**  
Printing begins.

# SELECTING THE PAPER

This section explains the [Paper Feed] settings ("Paper Source" setting in [General] in Mac OS 9) in the print settings window.

- **When [Auto Select] is selected**

A tray with plain paper or recycled paper (the factory default setting is plain paper only) of the size specified in "Paper Size" in the page settings window is automatically selected.

- **When a paper tray is selected**

The specified tray is used for printing regardless of the "Paper Size" setting in the page settings window.

For the bypass tray, a paper type can also be specified. Make sure that the paper type setting for the bypass tray is correct and that the set type of paper is actually loaded in the bypass tray, and then select the appropriate bypass tray (paper type).



- Special media such as envelopes can also be placed in the bypass tray. For the procedure for loading paper and other media in the bypass tray, see "[LOADING PAPER IN THE BYPASS TRAY](#)" (page 1-33) in "1. BEFORE USING THE MACHINE".
- When "Enable Detected Paper Size in Bypass Tray" (disabled by factory default) or "Enable Selected Paper Type in Bypass Tray" (enabled by factory default) is enabled in the system settings (administrator), printing will not take place if the paper size or paper type specified in the printer driver is different from the paper size or paper type specified in the settings of the bypass tray.

- **When a paper type is selected**

A tray with the specified type of paper and the size specified in "Paper Size" in the page settings window is used for printing.



**System Settings (Administrator): Exclude Bypass-Tray from Auto Paper Select**

When [Auto Select] is used for printing, this setting determines whether or not the paper in the bypass tray will be excluded from the paper that can be selected. This setting is disabled by factory default, and thus paper in the bypass tray is included in the paper that can be automatically selected. If special media are frequently loaded in the bypass tray, it is recommended that this setting be enabled.

# PRINTING ON ENVELOPES

The bypass tray can be used to print on special media such as envelopes. The procedure for printing on an envelope from the printer driver properties screen is described below.

For the types of paper that can be used in the bypass tray, see "[IMPORTANT POINTS ABOUT PAPER](#)" (page 1-27) in "BEFORE USING THE MACHINE". For the procedure for loading paper in the bypass tray, see "[LOADING PAPER IN THE BYPASS TRAY](#)" (page 1-33) in "1. BEFORE USING THE MACHINE".

Select the envelope size in the appropriate settings of the application ("Page Settings" in many applications) and then perform the following steps.

1

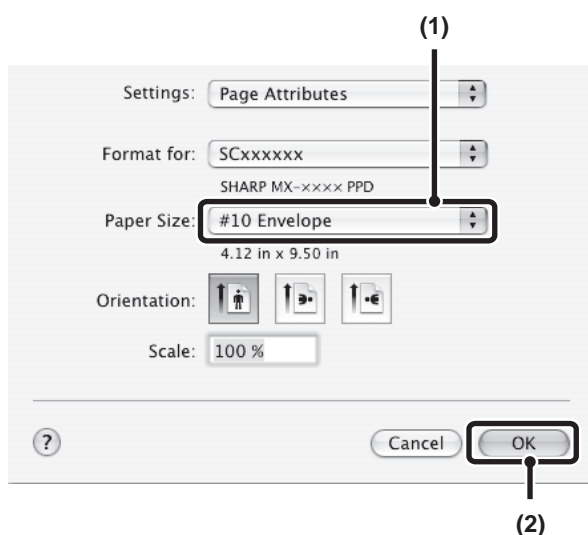

## Select the paper size.

**(1) Select the envelope size from the "Paper Size" menu on the page setup screen.**

In Mac OS 9, select the envelope size from the "Paper" menu on the page setup screen.

**(2) Click the [OK] button.**

In the case of media that can only be loaded in a certain orientation such as an envelope, you can rotate the image 180 degrees if needed. For more information, see "[ROTATING THE PRINT IMAGE 180 DEGREES \(Rotate 180 degrees\)](#)" (page 3-38).

2

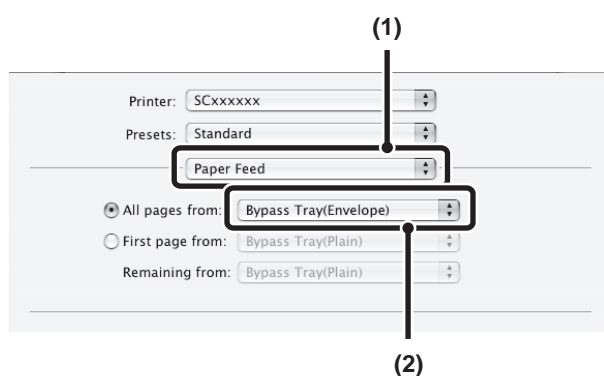

## Select the bypass tray.

**(1) Select [Paper Feed] on the print screen.**

In Mac OS 9, select [General].

**(2) Select [Bypass Tray(Envelope)] from the "All pages from" menu.**

- In Mac OS 9, select [Bypass Tray(Envelope)] from the "All pages from" menu of "Paper Source".
- Set the paper type of the bypass tray to [Envelope] and make sure the envelope is loaded in the bypass tray.

For more information on "Paper Feed", see "[SELECTING THE PAPER](#)" (page 3-20).

It is recommended that you do a test print to check the print result before using an envelope.

# PRINTING WHEN THE USER AUTHENTICATION FUNCTION IS ENABLED

When the user authentication function is enabled in the machine's system settings (administrator), you must enter your user information (login name, password, etc.) in order to print. The information that must be entered varies depending on the authentication method being used, so check with the administrator of the machine before printing.

1

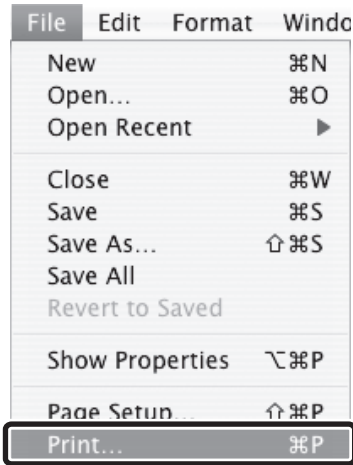

Select [Print] from the application's [File] menu.



The menu used to execute printing may vary depending on the software application.

2

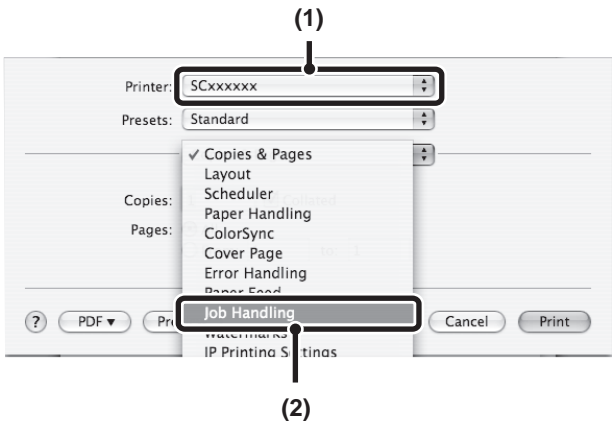

Display the job handling screen.

(1) Make sure that the machine's printer name is selected.

(2) Select [Job Handling].

- In Mac OS X v10.5 to 10.5.8 and v10.6 to 10.6.2, select [Job Handling] and then click the [Authentication] tab in the screen that appears.
- In Mac OS 9, select [User Authentication].



The machine name that appears in the "Printer" menu is normally [SCxxxxxx]. ("xxxxxx" is a sequence of characters that varies depending on the machine model.)



3

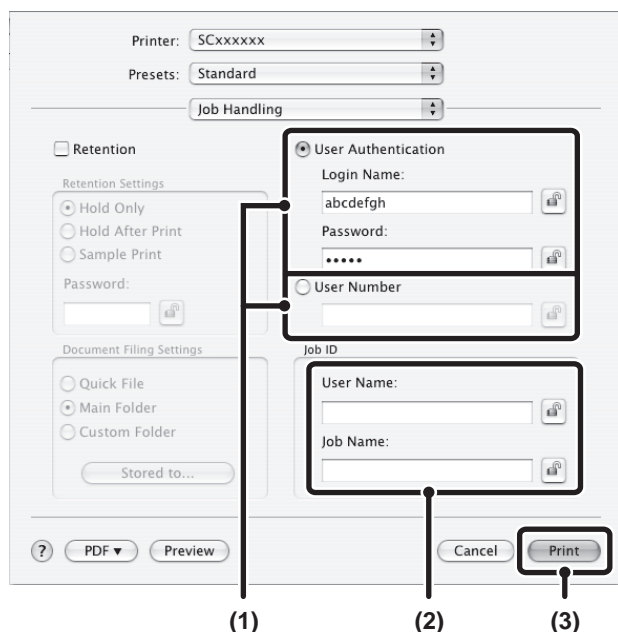

**Start printing.**



**(1) Enter your user information.**

- **When authentication is by login name/password**  
Enter your login name in "Login Name" and your password in "Password" (1 to 32 characters).
- **When authentication is by user number**  
Enter your user number (5 to 8 digits) in "User Number".

**(2) Enter the user name and job name as necessary.**

- **User Name**  
Enter your user name (maximum of 32 characters). Your entered user name will appear at the top of the operation panel. If you do not enter a user name, your computer login name will appear.
- **Job Name**  
Enter a job name (maximum of 30 characters). The entered job name will appear at the top of the operation panel as a file name. If you do not enter a job name, the file name set in the software application will appear.

**(3) Click the [Print] button.**

 In Mac OS X, you can click the  (lock) button after entering your login name and password, or user number, to simplify operation the next time you wish to print based on the same user authentication.

 Even when user authentication is enabled in the system settings (administrator), normally printing is possible without entering user information. The number of pages printed is added to the "Other User" count. In this case, other print functions may be restricted. For more information, ask your administrator.

 **System Settings (Administrator): Disabling of Printing by Invalid User**  
This is used to prohibit printing of print jobs by users whose user information is not stored in the machine. When this function is enabled, printing is not allowed when user information is not entered or incorrect information is entered.

# FREQUENTLY USED FUNCTIONS

This section explains frequently used functions.

- [SELECTING A PRINT MODE SETTING](#)
- [TWO-SIDED PRINTING](#) (page 3-26)
- [FITTING THE PRINT IMAGE TO THE PAPER](#) (page 3-28)
- [PRINTING MULTIPLE PAGES ON ONE PAGE](#) (page 3-29)
- [STAPLING OUTPUT](#) (page 3-31)

The explanations assume that the paper size and other basic settings have already been selected. For the basic procedure for printing and the steps for opening the printer driver properties window, see the following section:

- ☞ Windows: [BASIC PRINTING PROCEDURE](#) (page 3-4)
- ☞ Macintosh: [BASIC PRINTING PROCEDURE](#) (page 3-17)

 In Windows, view printer driver Help for details on printer driver settings for each printing function.

## SELECTING A PRINT MODE SETTING

This section explains the procedure for selecting a print mode setting. The "Print Mode Settings" consist of the following three items:

- Normal: This mode is suitable for printing data such as regular text or a table.
- High Quality: The print quality of photos and text is high.
- Fine: Select this when you want to print a photo with greater clarity or print graphics with gradations, etc.

### Windows

(This function is not available when using the PCL5e printer driver.)

- (1) Click the [Advanced] tab.
- (2) Select the "Print Mode".

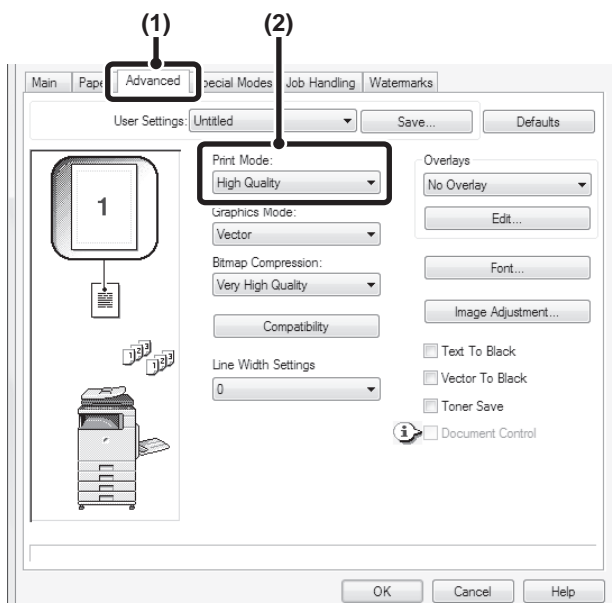



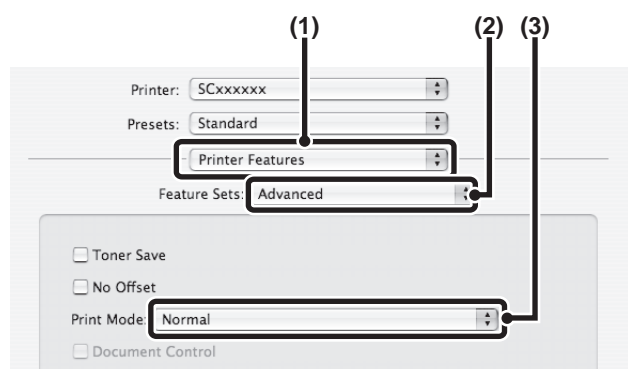

## Macintosh

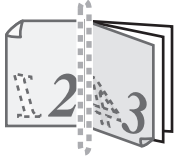

- (1) Select [Printer Features].
- (2) Select [Advanced].
- (3) Select the "Print Mode".

# TWO-SIDED PRINTING

The machine can print on both sides of the paper. This function is useful for many purposes, and is particularly convenient when you want to create a simple pamphlet. Two-sided printing also helps conserve paper.

Orientation	Print results			
	Windows	Macintosh	Windows	Macintosh
Vertical	2-Sided(Book)	Long-edged binding (Flip on long edge)	2-Sided(Tablet)	Short-edged binding (Flip on short edge)
				
Horizontal	2-Sided(Book)	Short-edged binding (Flip on short edge)	2-Sided(Tablet)	Long-edged binding (Flip on long edge)
				
The pages are printed so that they can be bound at the side.			The pages are printed so that they can be bound at the top.	

## Windows

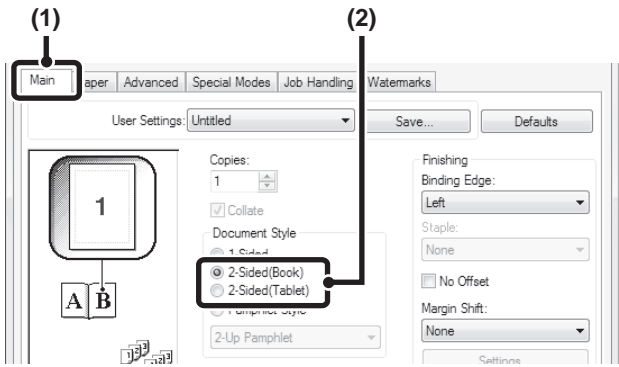

- (1) Configure the settings on the [Main] tab.
- (2) Select [2-Sided(Book)] or [2-Sided(Tablet)].

# Macintosh

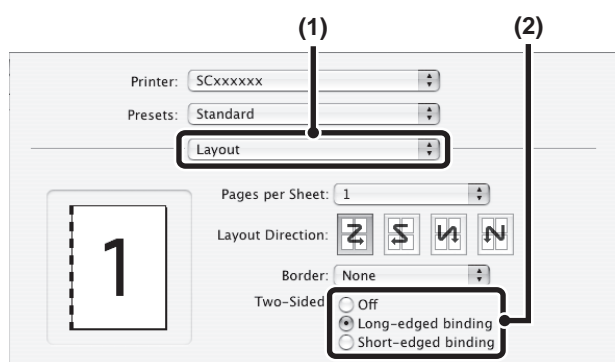

- (1) Select [Layout].
- (2) Select [Long-edged binding] or [Short-edged binding].



- In Mac OS X v10.2.8, select the settings in [Advanced].
- In Mac OS 9, select [Output/Document Style] and then select [Flip on long edge] or [Flip on short edge].

# FITTING THE PRINT IMAGE TO THE PAPER

This function is used to automatically enlarge or reduce the printed image to match the size of the paper loaded in the machine.

This is convenient for such purposes as enlarging an invoice or A5 size document to letter or A4 size to make it easier to view, and to print when the same size of paper as the document image is not loaded in the machine.

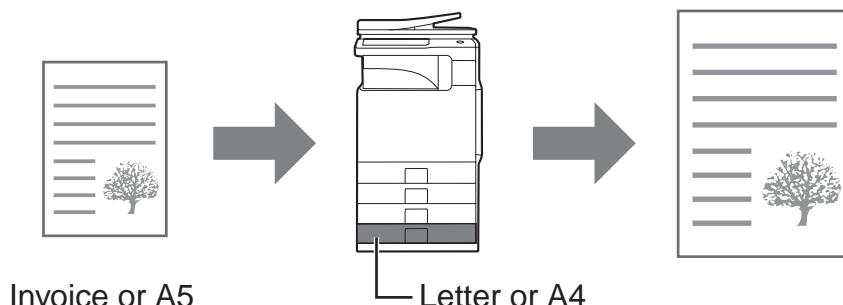

The following example explains how to print an invoice size document on letter size paper.

## Windows

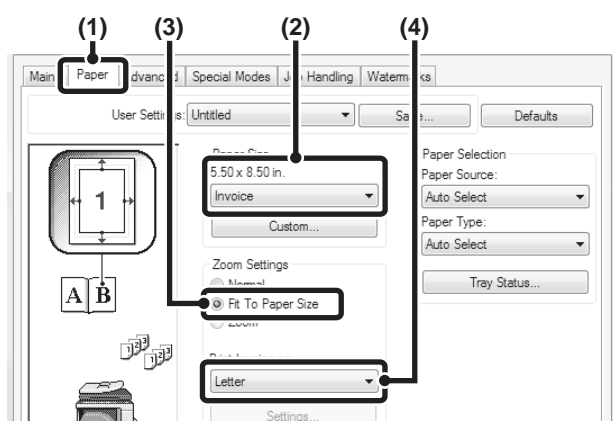

- (1) Click the [Paper] tab.
- (2) Select the size of the print image (for example: Invoice).
- (3) Select [Fit To Paper Size].
- (4) Select the actual paper size to be used for printing (for example: Letter).

## Macintosh

(This function can only be used in Mac OS X v10.4.11, v10.5 to 10.5.8 and v10.6 to 10.6.2.)

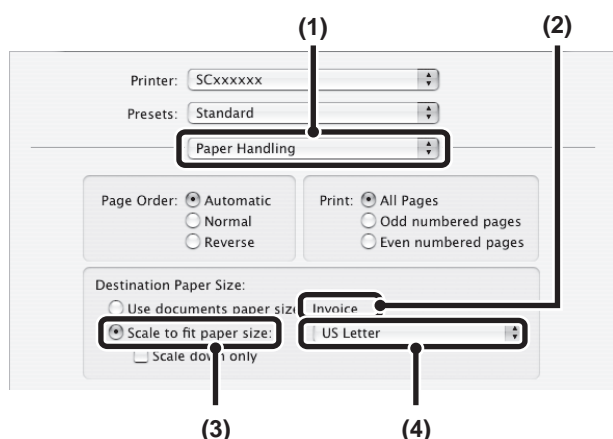



- (1) Select [Paper Handling].
- (2) Check the size of the print image (for example: Invoice).  
To change the print image size, use the "Paper Size" menu that appears when [Page Setup] is selected.
- (3) Select [Scale to fit paper size].
- (4) Select the actual paper size to be used for printing (for example: Letter).



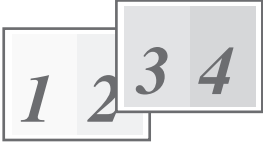

# PRINTING MULTIPLE PAGES ON ONE PAGE

This function can be used to reduce the print image and print multiple pages on a single sheet of paper.

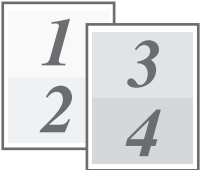
This is convenient when you want to print multiple images such as photos on a single sheet of paper, and when you want to conserve paper. This function can also be used in combination with two-sided printing for maximum conservation of paper.

For example, when [2-Up] (2 pages per sheet) and [4-Up] (4 pages per sheet) are selected, the following print results will be obtained, depending on the order selected.

N-Up (Pages per sheet)	Print results		
	Left To Right	Right To Left	Top To Bottom (When the print orientation is landscape)
2-Up (2 pages per sheet)			

N-Up (Pages per sheet)	Right, and Down	Down, and Right	Left, and Down	Down, and Left
4-Up (4 pages per sheet)				



- The page orders for 6-Up, 8-Up, 9-Up, and 16-Up are the same as for 4-Up.
- In a Windows environment, the page order can be viewed in the print image in the printer driver properties window. In a Macintosh environment, the page orders are displayed as selections.
- In a Macintosh environment, the number of pages that can be printed on a single sheet is 2, 4, 6, 9, or 16.

## Windows

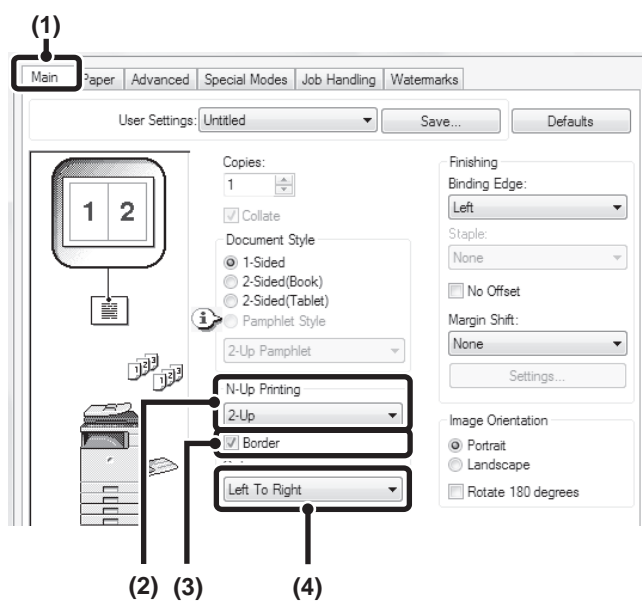

- (1) Configure the settings on the [Main] tab.
- (2) Select the number of pages per sheet.
- (3) If you wish to print borderlines, click the [Border] checkbox so that a checkmark  appears.
- (4) Select the order of the pages.

## Macintosh

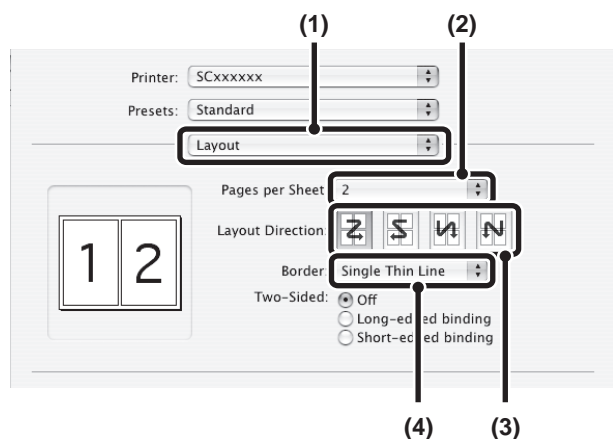

- (1) Select [Layout].
- (2) Select the number of pages per sheet.
- (3) Select the order of the pages.
- (4) If you wish to print borderlines, select the desired type of borderline.



# STAPLING OUTPUT

The staple function can be used to staple output.

This function saves considerable time when preparing handouts for a meeting or other stapled materials. The staple function can also be used in combination with two-sided printing to create materials with a more sophisticated appearance.

Stapling positions can be selected to obtain the following stapling results.

\* Stapling takes place in one location only.

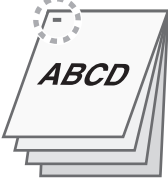
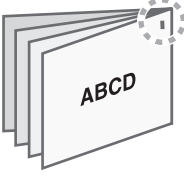
Orientation	Left	Right	Top
Vertical		/	
Horizontal	/		/



- To use the staple function, a finisher is required.
- For the maximum number of sheets that can be stapled, see "[PERIPHERAL DEVICES](#)" (page 1-43) in "1. BEFORE USING THE MACHINE". The maximum number of sheets that can be stapled at once includes any covers and/or inserts that are inserted.
- The staple function cannot be used in combination with the offset function, which offsets the position of each output job from the previous job.
- When the staple function is disabled in the machine's system settings (administrator), stapling is not possible.

## Windows

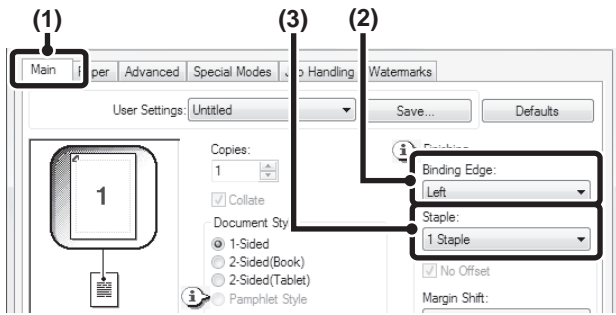

- (1) Configure the settings on the [Main] tab.
- (2) Select the "Binding Edge".
- (3) Select the staple function.

For the staple function, select the number of staples in the "Staple" menu.

## Macintosh

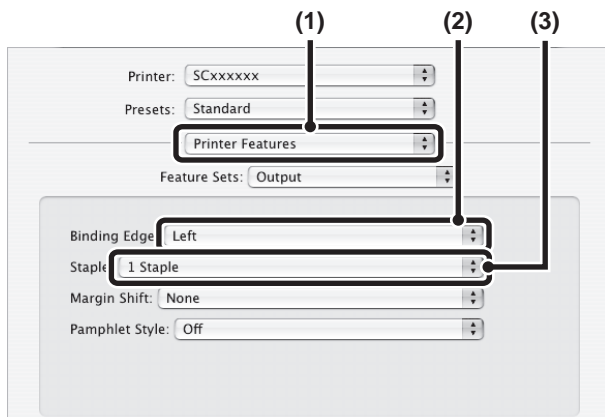

- (1) Select [Printer Features].
- (2) Select the "Binding Edge".
- (3) Select the staple function.

For the staple function, select the number of staples in the "Staple" menu.



- In Mac OS X v10.2.8, select the settings in [Advanced].
- In Mac OS 9, select the settings in [Output/Document Style].

# CONVENIENT PRINTING FUNCTIONS

This section explains convenient functions for specific printing objectives.

- [CONVENIENT FUNCTIONS FOR CREATING PAMPHLETS AND POSTERS](#)
- [FUNCTIONS TO ADJUST THE SIZE AND ORIENTATION OF THE IMAGE](#) (page 3-38)
- [IMAGE ADJUSTMENT FUNCTION](#) (page 3-42)
- [FUNCTIONS THAT COMBINE TEXT AND IMAGES](#) (page 3-44)
- [PRINT FUNCTIONS FOR SPECIAL PURPOSES](#) (page 3-47)
- [CONVENIENT PRINTER FUNCTIONS](#) (page 3-52)

The explanations assume that the paper size and other basic settings have already been selected. For the basic procedure for printing and the steps for opening the printer driver properties window, see the following section:

- ☞ Windows: [BASIC PRINTING PROCEDURE](#) (page 3-4)
- ☞ Macintosh: [BASIC PRINTING PROCEDURE](#) (page 3-17)



In Windows, view printer driver Help for details on printer driver settings for each printing function.

# CONVENIENT FUNCTIONS FOR CREATING PAMPHLETS AND POSTERS

## CREATING A PAMPHLET (Pamphlet)

The pamphlet function prints on the front and back of each sheet of paper so that the sheets can be folded and bound to create a pamphlet. This is convenient when you wish to compile printed output into a pamphlet.

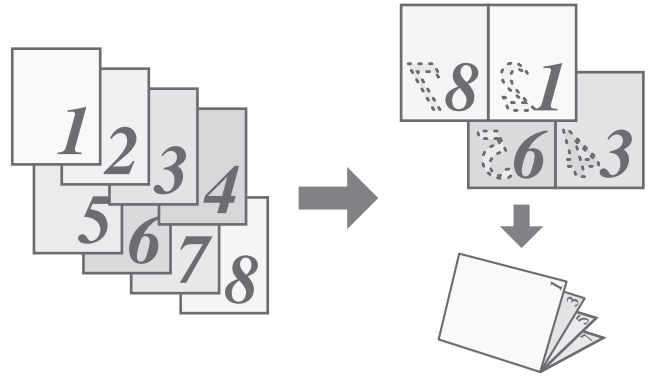

### Windows

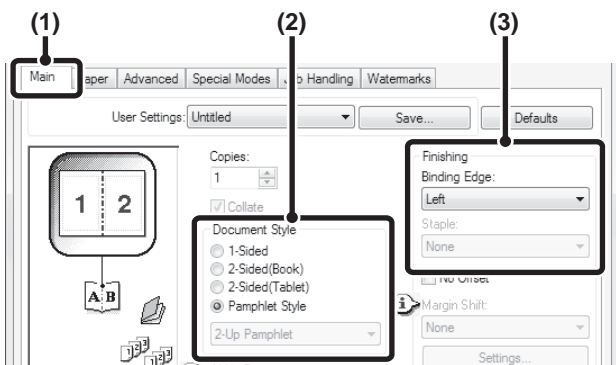

- (1) Configure the settings on the [Main] tab.
- (2) Select [Pamphlet Style].
- (3) Select the "Binding Edge".

Macintosh

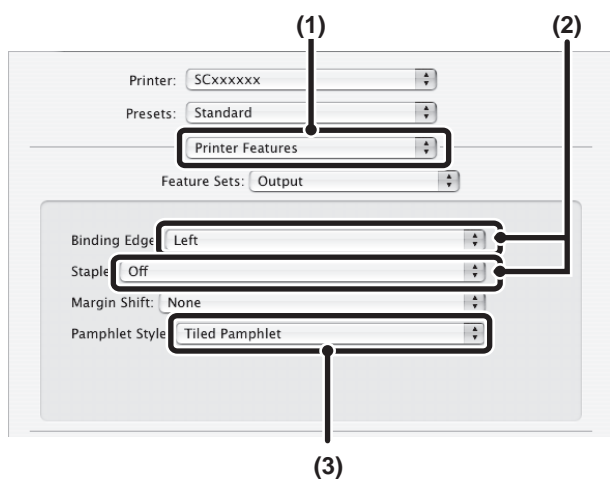

- (1) Select [Printer Features].
- (2) Select the "Binding Edge".
- (3) Select [Tiled Pamphlet] or [2-Up Pamphlet].



- In Mac OS X v10.2.8, select from the "2-Side Printing" and "Binding Edge" menus in [Advanced].
- In Mac OS 9, select the settings in [Output/Document Style].

# INCREASING THE MARGIN (Margin Shift)

This function is used to shift the print image to increase the margin at the left, right, or top of the paper. This is convenient when you wish to staple or punch the output but the binding area overlaps the text. When a finisher is installed, the staple function can be used with this function.

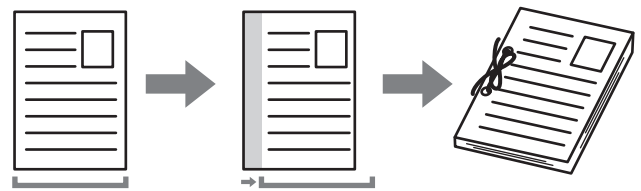

## Windows

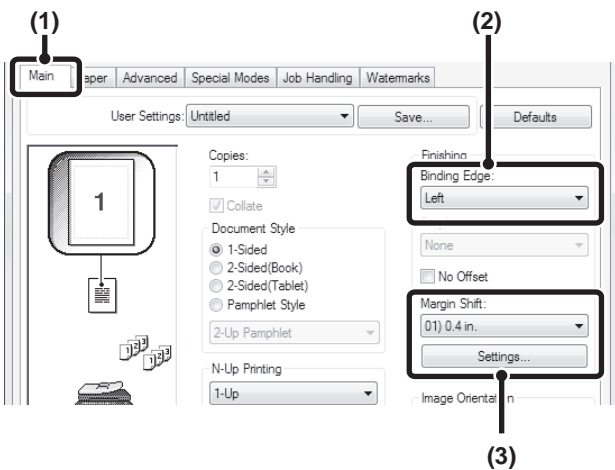

- (1) Configure the settings on the [Main] tab.
- (2) Select the "Binding Edge".
- (3) Select the "Margin Shift".

Select from the "Margin Shift" menu. If you wish to configure another numeric setting, select the setting from the pull-down menu and click the [Settings] button. Click the button or directly enter the number.

## Macintosh

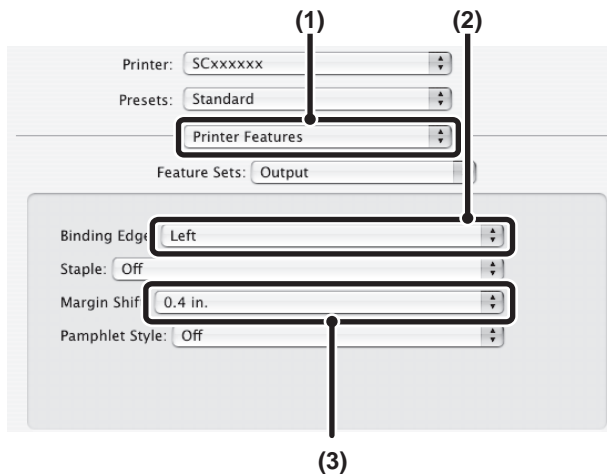

- (1) Select [Printer Features].
- (2) Select the "Binding Edge".
- (3) Select the "Margin Shift".



- In Mac OS X v10.2.8, select from the "Binding Edge" and "Margin Shift" menus in [Advanced].
- In Mac OS 9, select [Advanced] and then select the binding edge and margin shift from the margin shift menu.

# CREATING A LARGE POSTER (Poster Printing)

(This function is only available in Windows.)

One page of print data can be enlarged and printed using multiple sheets of paper (4 sheets (2 x 2), 9 sheets (3 x 3) or 16 sheets (4 x 4)). The sheets can then be attached together to create a large poster. To enable precise alignment of the edges of the sheets during attachment, borderlines can be printed and overlapping edges can be created (overlap function).

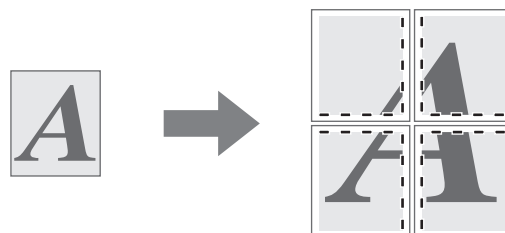

## Windows

(This function can be used when the PCL6 or PS printer driver is used.)

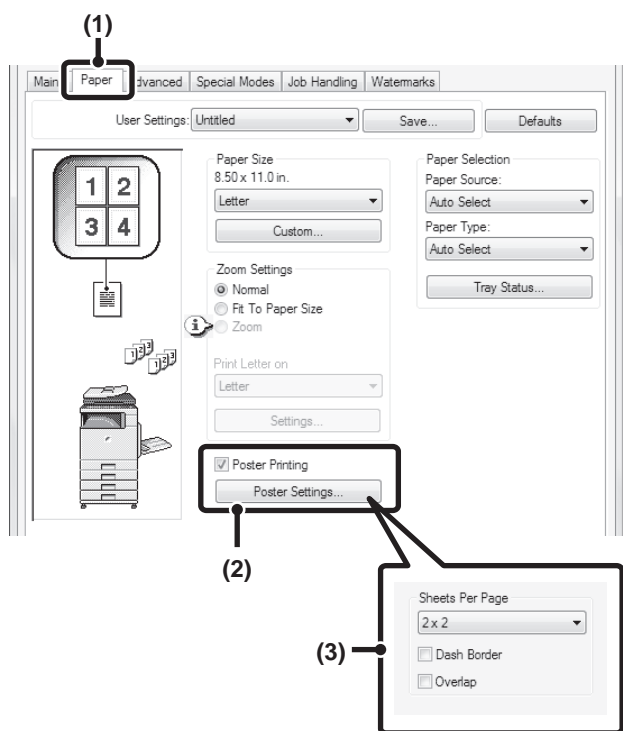

- (1) Click the [Paper] tab.
- (2) Select the [Poster Printing] checkbox  and click the [Poster Settings] button.
- (3) Select poster settings.  
Select the number of sheets of paper to be used from the pull-down menu. If you wish to print borderlines and/or use the overlap function, select the corresponding checkboxes .

# FUNCTIONS TO ADJUST THE SIZE AND ORIENTATION OF THE IMAGE

## ROTATING THE PRINT IMAGE 180 DEGREES (Rotate 180 degrees)

This feature rotates the image 180 degrees so that it can be printed correctly on paper that can only be loaded in one orientation (such as envelopes or paper with punch holes). (In Mac OS X, a portrait image cannot be rotated 180 degrees.)

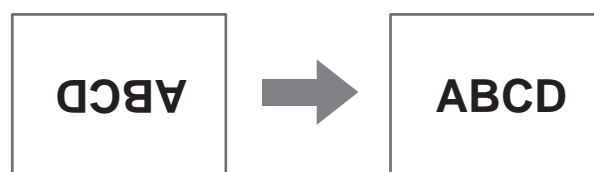

### Windows

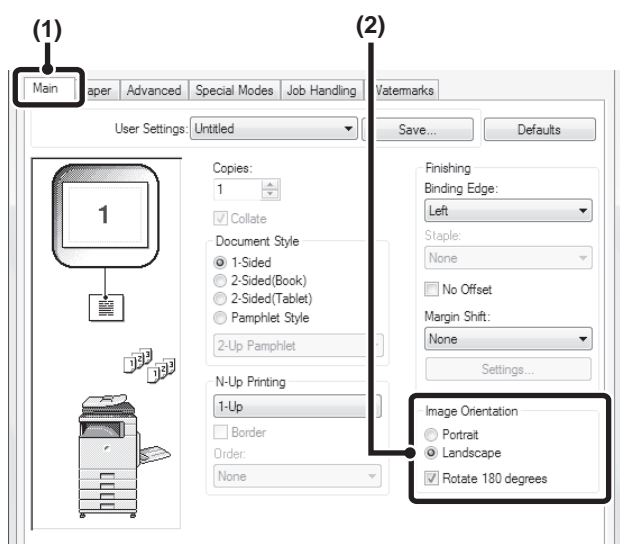

- (1) Select the setting on the [Main] tab.
- (2) Select the [Rotate 180 degrees] checkbox .

### Macintosh

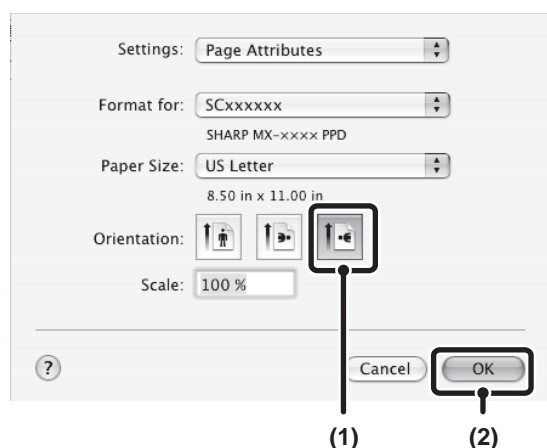

- (1) Select [Page Setup] from the [File] menu and click the button.  
In Mac OS 9, select [Page Setup] from the [File] menu and select [PostScript Options]. Then select the [Flip Horizontal] and [Flip Vertical] checkbox .
- (2) Click the [OK] button.



# ENLARGING/REDUCING THE PRINT IMAGE (Zoom/XY-Zoom)

This function is used to enlarge or reduce the image to a selected percentage. This allows you to enlarge a small image or add margins to the paper by slightly reducing an image.

When using the PS printer driver (Windows), you can set the width and length percentages separately to change the proportions of the image. (XY-Zoom)

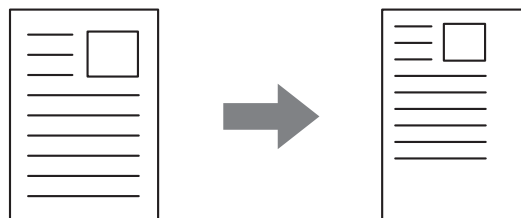

## Windows

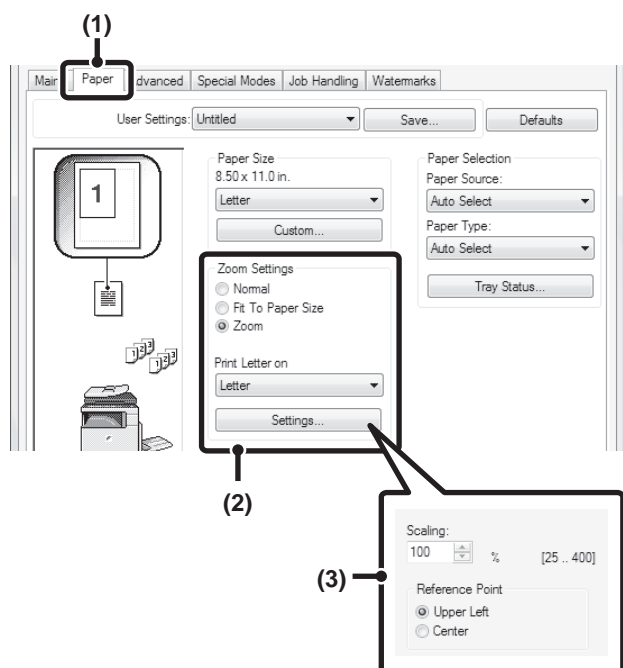

- (1) Click the [Paper] tab.
- (2) Select [Zoom] and click the [Settings] button.

The actual paper size to be used for printing can be selected from the pull-down menu.

- (3) Select the zoom ratio.

Directly enter a number (%) or click the button to change the ratio in increments of 1%. You can also select [Upper Left] or [Center] for the base point on the paper.

## Macintosh

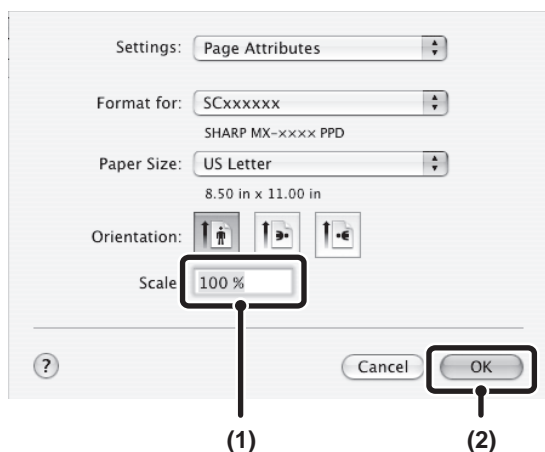

- (1) Select [Page Setup] from the [File] menu and enter the ratio (%).

In Mac OS 9, select [Page Setup] from the [File] menu and enter the ratio (%).

- (2) Click the [OK] button.

# ADJUSTING LINE WIDTHS WHEN PRINTING (Line Width Settings)

(This function is only available in Windows.)

When lines in special applications such as CAD cannot be printed correctly, this setting can be used to adjust line widths, such as making overall line widths wider. (This setting is only effective for vector data; raster data such as bitmap images cannot be adjusted.) When the data includes lines of varying widths, you can also print all lines at the minimum width.

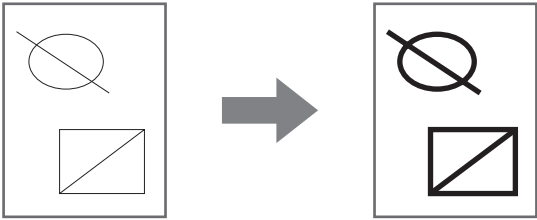

## Windows

(This function can be used when the PCL6 printer driver is used.)

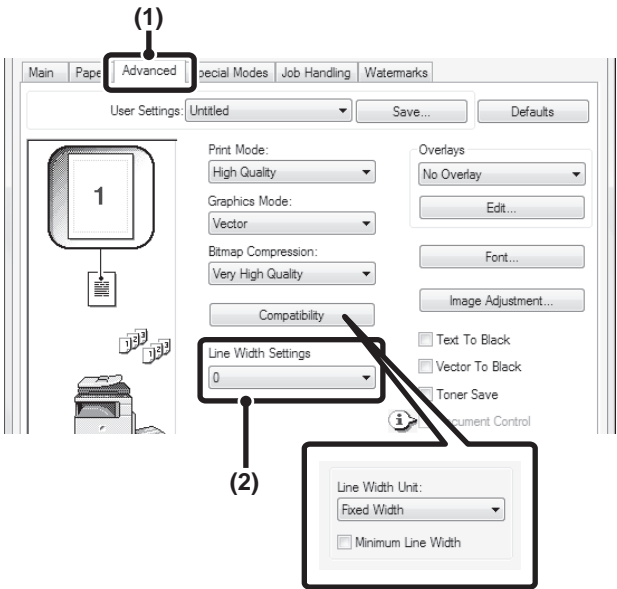

(1) Click the [Advanced] tab.

(2) Adjust the line width.

Select a number from the pull-down menu.



- The units of line-width adjustment can be set to "Fixed Width" or "Ratio". Click the [Compatibility] button and select the units from the "Line Width Unit" menu.
- To print all lines in the data at the minimum line width, click the [Compatibility] button and select the [Minimum Line Width] checkbox (☑).

# REVERSING THE IMAGE (Mirror Image)

The image can be reversed to create a mirror image. This function can be used to conveniently print a design for a woodblock print or other printing medium.

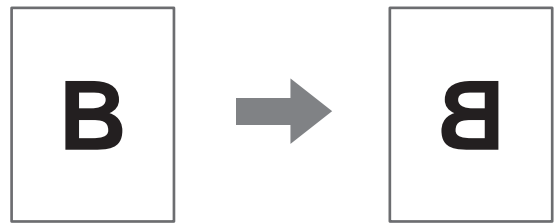

## Windows

(This function can be used when the PS printer driver is used.)

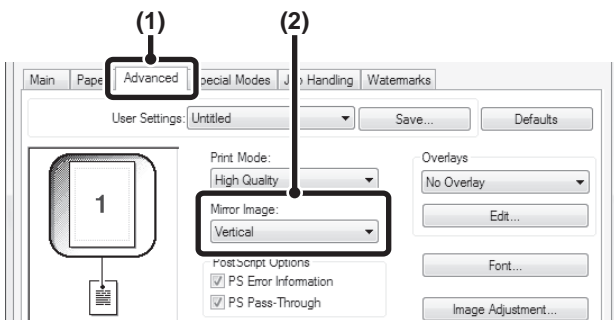

- (1) Click the [Advanced] tab.
- (2) Select a mirror image setting.

If you wish to reverse the image horizontally, select [Horizontal]. If you wish to reverse the image vertically, select [Vertical].

## Macintosh

(This function can only be used in Mac OS 9.)

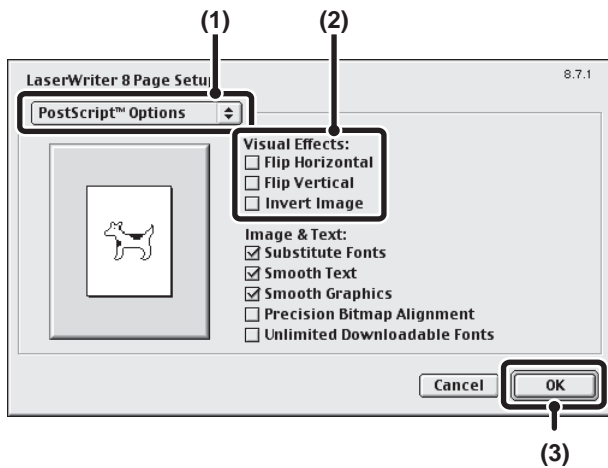

- (1) Select [Page Setup] from the [File] menu and select [PostScript Options].
- (2) Select "Visual Effects".  
To reverse the image horizontally, select [Flip Horizontal].  
To reverse the image vertically, select [Flip Vertical].
- (3) Click the [OK] button.

# IMAGE ADJUSTMENT FUNCTION

## ADJUSTING THE BRIGHTNESS AND CONTRAST OF THE IMAGE (Image Adjustment)

(This function is only available in Windows.)

The brightness and contrast can be adjusted in the print settings when printing a photo or other image. These settings can be used for simple corrections when you do not have image editing software installed on your computer.

### Windows

(This function is not available when using the PCL5e printer driver.)

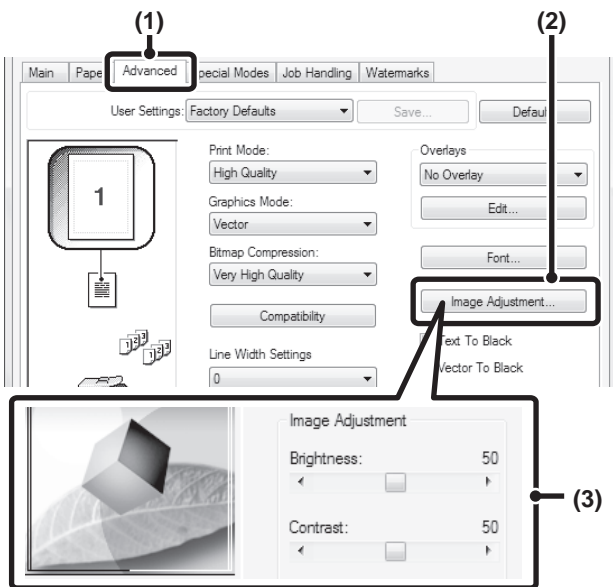

- (1) Click the [Advanced] tab.
- (2) Click the [Image Adjustment] button.
- (3) Adjust the image settings.

To adjust a setting, drag the slide bar  or click the  or  button.

# PRINTING FAINT TEXT AND LINES IN BLACK (Text To Black/Vector To Black)

(This function is only available in Windows.)

When printing a color image, color text and lines that are faint can be printed in black. (Raster data such as bitmap images cannot be adjusted.) This allows you to bring out color text and lines that are faint and difficult to see.

- [Text To Black] can be selected to print all text other than white text in black.
- [Vector To Black] can be selected to print all vector graphics other than white lines and areas in black.

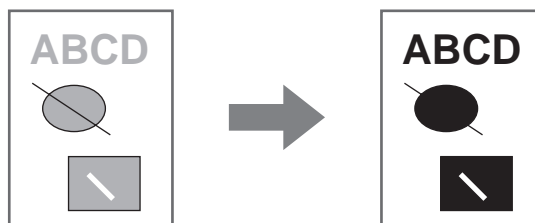

## Windows

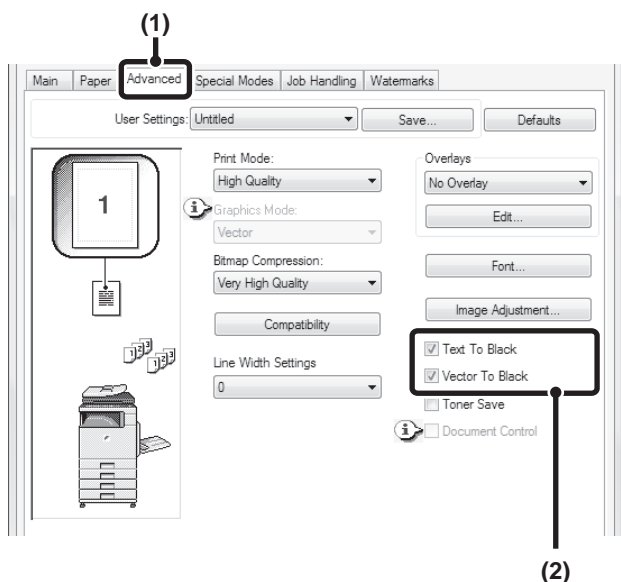

- (1) Click the [Advanced] tab.
- (2) Select the [Text To Black] checkbox  and/or the [Vector To Black] checkbox .

# FUNCTIONS THAT COMBINE TEXT AND IMAGES

## ADDING A WATERMARK TO PRINTED PAGES (Watermark)

Faint shadow-like text can be added to the background of the printed image as a watermark. The size, angle, and print position of the watermark text can be adjusted. The text can be selected from a pre-stored list, or entered to create an original watermark.

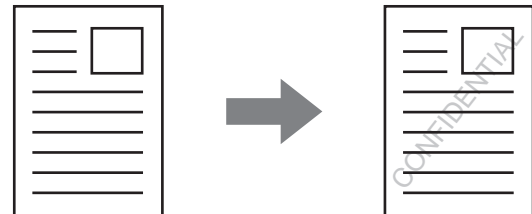

### Windows

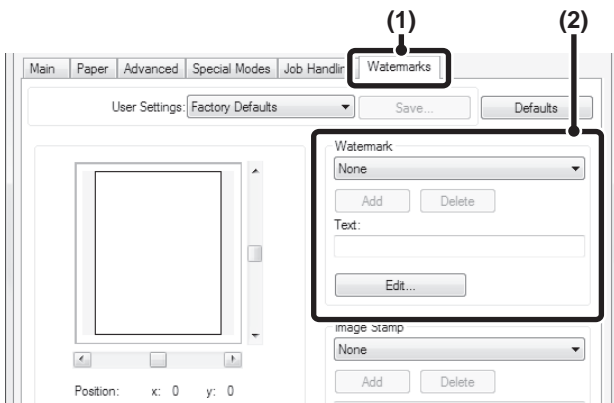

(1) Click the [Watermarks] tab.

(2) Select the watermark settings.

Select a stored water mark from the pull-down menu. You can click the [Edit] button to edit the font and select other detailed settings.



**If you wish to create a new watermark...**

Enter the text of the watermark in the "Text" box and click the [Add] button.

### Macintosh

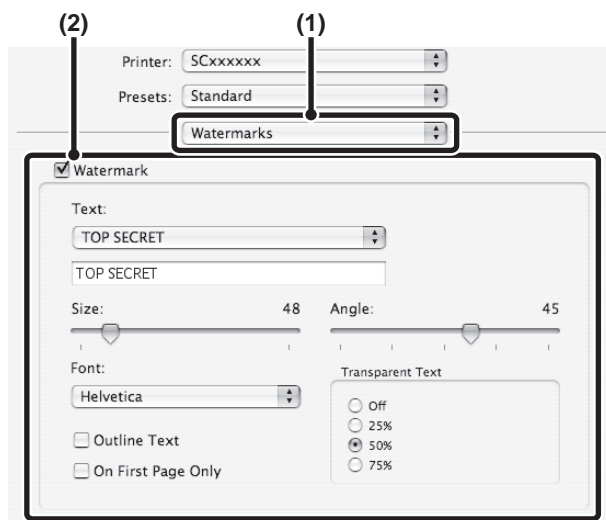

(1) Select [Watermarks].

(2) Click the [Watermark] checkbox and configure watermark settings.

Detailed watermark settings can be configured such as selection of the text and editing of the font. Adjust the size and angle of the text by dragging the slide bar.



In Mac OS 9, select [Watermark] and configure the settings.

# PRINTING AN IMAGE OVER THE PRINT DATA (Image Stamp)

(This function is only available in Windows.)

A bitmap or JPEG image stored on your computer can be printed over the print data. The size, position, and angle of the image can be adjusted. This feature can be used to "stamp" the print data with a frequently used image or an icon of your own creation.

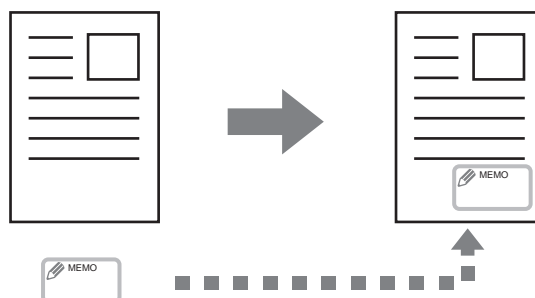

## Windows

(This function can be used when the PCL6 or PS printer driver is used.)

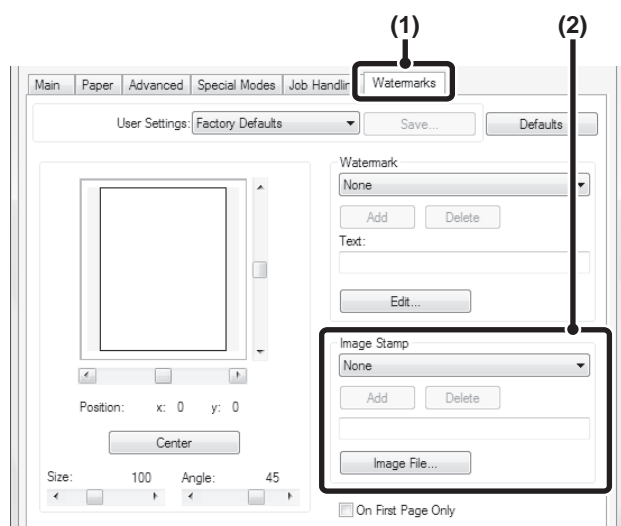

- (1) Click the [Watermarks] tab.
- (2) Select the image stamp setting.

If an image stamp has already been stored, it can be selected from the pull-down menu. If you have not stored an image stamp, click the [Image File], select the file you wish to use for the image stamp, and click the [Add] button.

# CREATING OVERLAYS FOR PRINT DATA (Overlays)

(This function is only available in Windows.)

The print data can be printed in a previously created overlay. By creating table rulings or a decorative frame in an application different from that of the text file and registering the data as an overlay file, an attractive print result can be easily obtained without the need for complex manipulations.

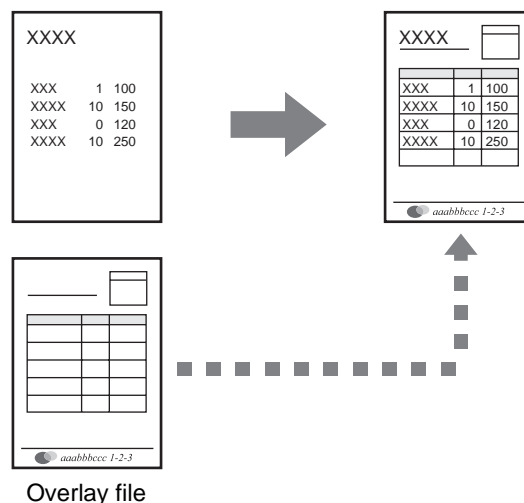

## Windows

### Create an overlay file.

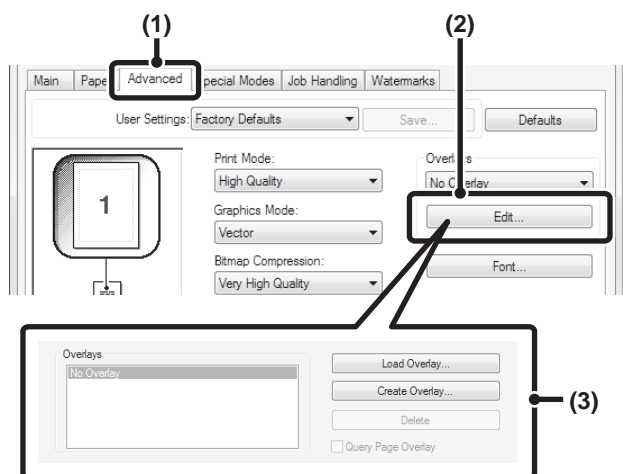

**(1) Click the [Advanced] tab.**

Configure the printer driver settings from the software application that you wish to use to create the overlay file.

**(2) Click the [Edit] button.**

**(3) Create an overlay file.**

Click the [Create Overlay] button and specify the name and folder to be used for the overlay file that you wish to create. The file will be created when the settings are completed and printing is started.



- When printing is started, a confirmation message will appear. The overlay file will not be created until the [Yes] button is clicked.
- To register a previously existing overlay file, click the [Load Overlay] button.

### Printing with an overlay file

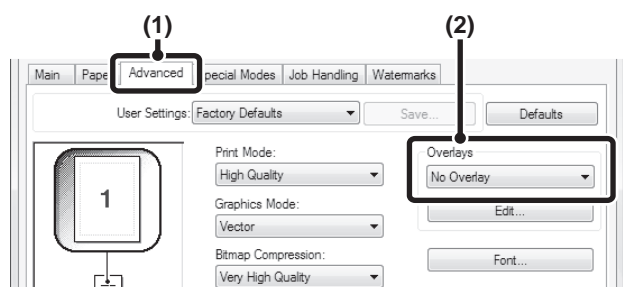

**(1) Click the [Advanced] tab.**

Configure the printer driver settings from the application from which you wish to print using the overlay file.

**(2) Select the overlay file.**

A previously created or stored overlay file can be selected from the pull-down menu.



# PRINT FUNCTIONS FOR SPECIAL PURPOSES

## PRINTING SPECIFIED PAGES ON DIFFERENT PAPER (Different Paper)

- Using this function in a Windows environment**  
 The front and back cover and specified pages of a document can be printed on paper that is different from the other pages. Use this function when you wish to print the front and back cover on heavy paper, or insert colored paper or a different paper type at specified pages. You can also insert paper as an insert without printing on it.
- Using this function in a Macintosh environment**  
 The front cover and last page can be printed using paper that is different from the other pages. This function can be used, for example, when you want to print only the front cover and last page on thick paper.

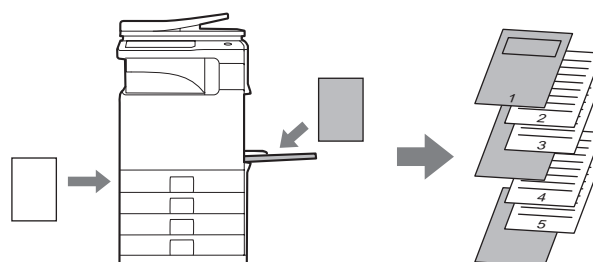

### Windows

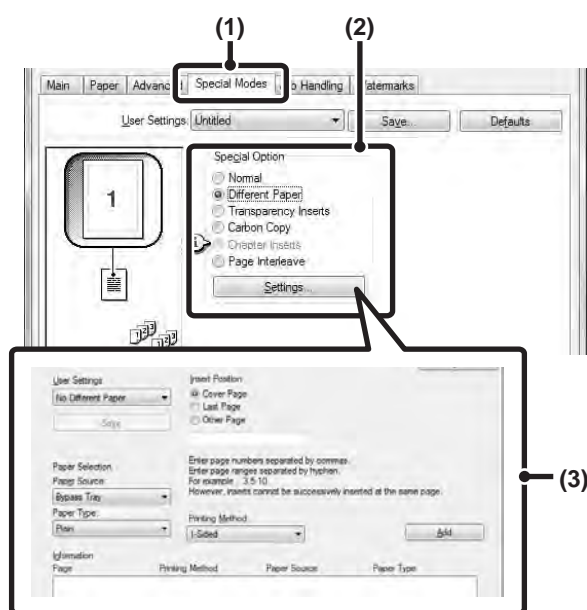

- Click the [Special Modes] tab.
- Select [Different Paper] and click the [Settings] button.
- Select paper insertion settings.

Select the insertion position, paper source, and printing method from the corresponding menus. Click the [Add] button to show the selected settings in "Information". When you have completed the settings, click the [Save] button in "User Settings" to save the settings.

- When [Bypass Tray] is selected in "Paper Source", be sure to select the "Paper Type" and load that type of paper in the bypass tray.
- About paper insertion settings**  
 When [Other Page] is selected for "Insert Position", the insert position can be specified by directly entering a page number. However, inserts cannot be successively inserted at the same page. When "Printing Method" is set to [2-Sided], the specified page and the next page after it will be printed on the front and reverse side of the paper, and thus an insert setting at a page printed on the reverse side will not be effective.

# Macintosh

(This function can only be used in Mac OS 9, Mac OS X v10.4.11, v10.5 to 10.5.8 and v10.6 to 10.6.2.)

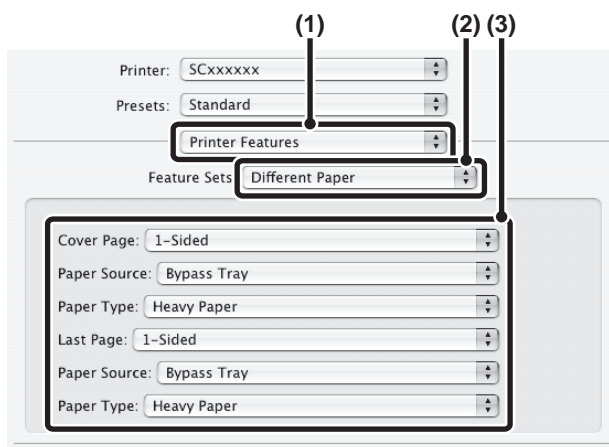

**(1) Select [Printer Features].**

**(2) Select [Different Paper].**

**(3) Select cover insertion settings.**

Select the print setting, paper tray, and paper type for the cover page and last page.



In Mac OS 9, select [Different Paper] and then select the settings for the cover page and last page.

# ADDING INSERTS WHEN PRINTING ON TRANSPARENCY FILM (Transparency Inserts)

When printing on transparency film, this function helps prevent the sheets of transparency film from sticking together by inserting a sheet of paper between each sheet of film. It is also possible to print the same content on each inserted sheet of paper as is printed on the corresponding sheet of transparency film.

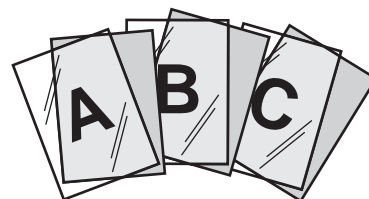

## Windows

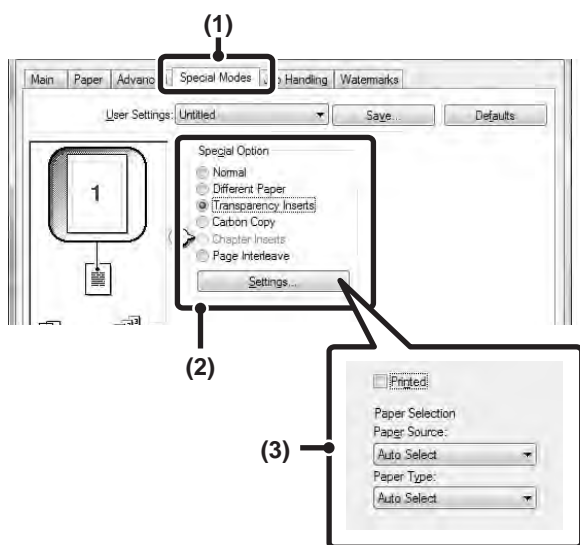

- (1) Click the [Special Modes] tab.
- (2) Select [Transparency Inserts] and click the [Settings] button.
- (3) Select transparency insert settings.

To print the same content on the insert as is printed on the sheet of transparency film, select the [Printed] checkbox . Select the paper source and type if needed.

Set [Transparency] for the "Paper Type" of the bypass tray.

## Macintosh

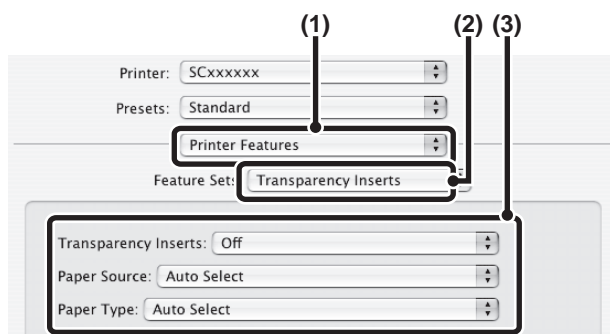

- (1) Select [Printer Features].
- (2) Select [Transparency Inserts].
- (3) Select transparency insert settings.

To print the same content on the insert as is printed on the sheet of transparency film, select [Print] in "Transparency Inserts". Select the paper source and type if needed.

- Set [Transparency] for the "Paper Type" of the bypass tray.
- In Mac OS X v10.2.8, select the [Transparency Inserts] checkbox  in [Advanced].
  - In Mac OS 9, select [Transparency Inserts] and select from the "Transparency Inserts" menu. Select the paper source and type if needed.

# PRINTING A CARBON COPY (Carbon Copy)

(This function is only available in Windows.)

This function is used to print an additional copy of the print image on paper that is the same size but from a different paper tray.

For example, if carbon copy print is selected when standard paper is loaded in tray 1 and colored paper is loaded in tray 2, a print result similar to a carbon copy slip can be obtained with a single selection of the print command. As another example, if standard paper is loaded in tray 1 and recycled paper is loaded in tray 2, Carbon Copy can simultaneously print one copy for presentation and one copy as a duplicate.

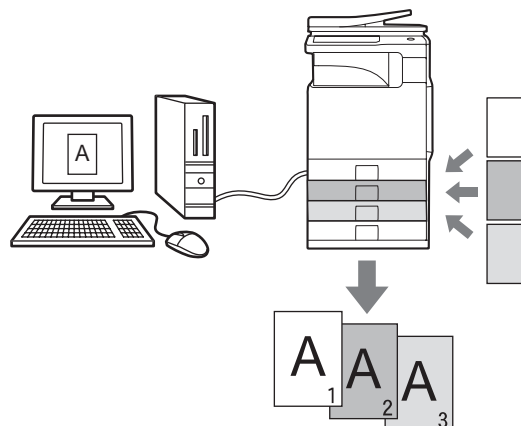

## Windows

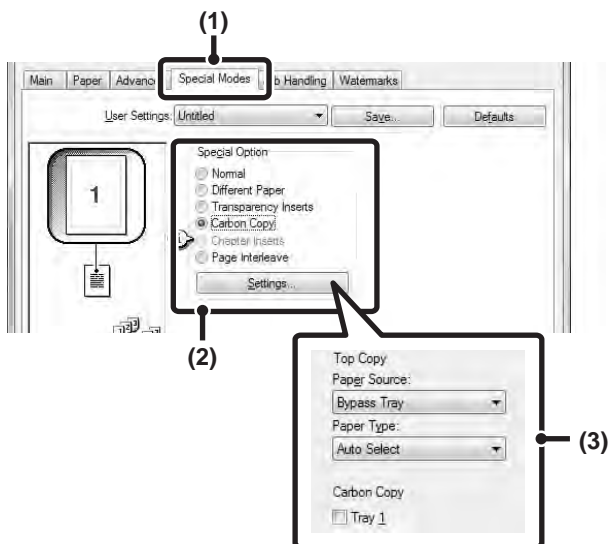

- (1) Click the [Special Modes] tab.
- (2) Select [Carbon Copy] and click the [Settings] button.
- (3) Select the carbon copy settings.

Select the tray for the "Top Copy" and then select the tray for the carbon copy (or copies) in "Carbon Copy".



When the bypass tray is selected, be sure to select the "Paper Type".

# TWO-SIDED PRINTING WITH SPECIFIC PAGES PRINTED ON THE FRONT SIDE (Chapter Inserts)

(This function is only available in Windows.)

You can have specific pages printed on the front side of the paper.

When a page (such as the first page of a chapter) is specified as a front side page, the page will be printed on the front side of the paper even if it would normally be printed on the reverse side (the reverse side will be left blank and the page will be printed on the front side of the next sheet of paper).

Example:

When pages 4 and 8 are specified as page settings.



Back is blank

## Windows

(This function can be used when the PCL6 printer driver is used.)

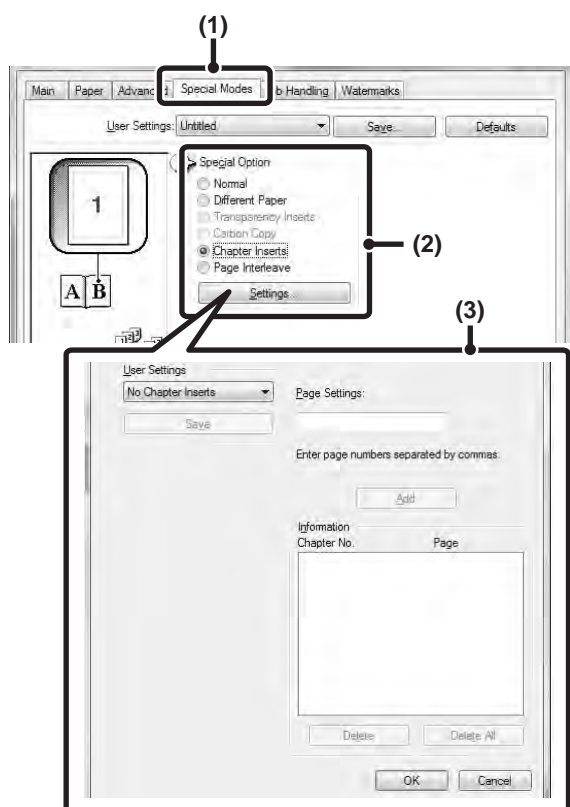

- (1) Click the [Special Modes] tab.
- (2) Select [Chapter Inserts] and click the [Settings] button.
- (3) Select the chapter settings.

Enter the page numbers that are to begin chapters in "Page Settings". Click the [Add] button and your settings will appear in "Information". When you have finished selecting settings, click the [Save] button in "User Settings" to save the settings.

---

---

# CONVENIENT PRINTER FUNCTIONS

## SAVING AND USING PRINT FILES (Retention/Document Filing)

This function is used to store a print job as a file on the machine's hard drive, allowing the job to be printed from the operation panel when needed. The location for storing a file can be selected to prevent the file from being mixed together with files of other users.

When printing from a computer, a password (5 to 8 digits) can be set to maintain the secrecy of information in a stored file.

When a password is set, the password must be entered to print a stored file from the machine.

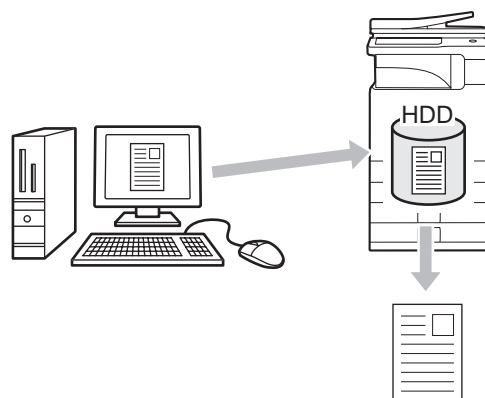

### Hold Only

This setting is used to hold a print job on the machine's hard drive without printing it.

### Hold After Print

This setting is used to hold a print job on the machine's hard drive after it is printed.

### Sample Print

When a print job is sent to the machine, only the first set of copies is printed. After checking the contents of the first set of copies, you can print the remaining sets from the operation panel of the machine. This prevents the occurrence of excessive misprints.

To print files stored on the machine's hard drive, see "[PRINTING A STORED FILE](#)" (page 6-32) in "6. DOCUMENT FILING".

Windows

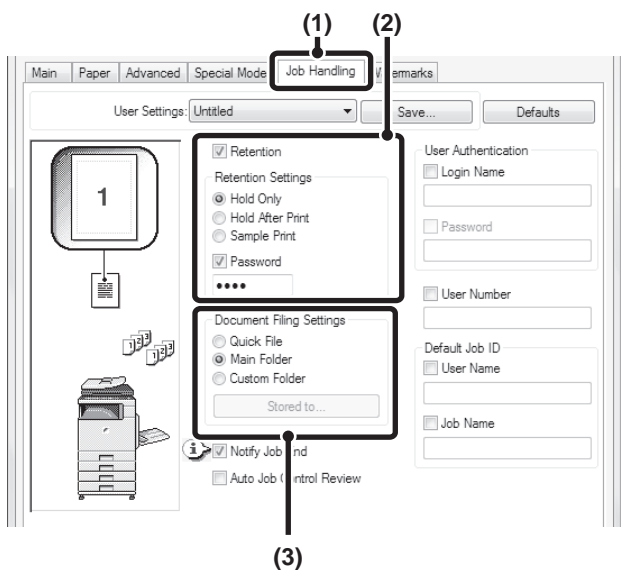

(1) Click the [Job Handling] tab.

(2) Select the retention setting.

Click the [Retention] checkbox . Select the retention method in "Retention Settings". To enter a password (5 to 8 digit number), click the [Password] checkbox .

(3) Select document filing settings.

Select the folder for storing the file in "Document Filing Settings". If you selected [Custom Folder], click the [Stored to] button to select the folder.



- When [Quick File] is selected, "Retention Settings" will be set to [Hold After Print] only.
- When [Quick File] is selected, the password entered in "Retention Settings" is cleared and cannot be used.
- To store a file in a custom folder, the custom folder must first be created using "Document Filing Control" in the system settings (administrator). If a password has been established for a custom folder, enter the "Folder Password" in the folder selection screen.
- When [Retention] has been checked on [Printing Policy] in the [Configuration] tab, the [Retention] checkbox is always checked and you cannot change the checkbox.
- In an IPV6 environment, files can only be stored in the main folder.

## Macintosh

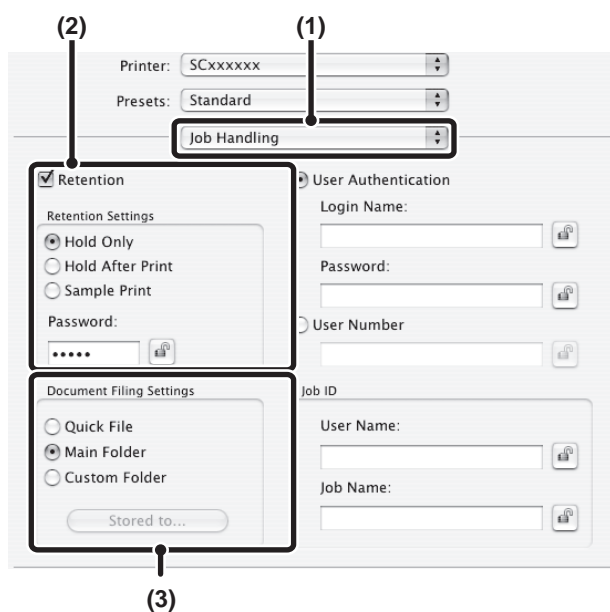

**(1) Select [Job Handling].**

**(2) Select the retention setting.**

Click the [Retention] checkbox . Select the retention method in "Retention Settings". To simplify operation the next time the same password is set, click the (lock) button after entering the password (5 to 8 digit number).

**(3) Select document filing settings.**

Select the folder for storing the file in "Document Filing Settings". If you selected [Custom Folder], click the [Stored to] button to select the folder.



- When [Quick File] is selected, "Retention Settings" will be set to [Hold After Print] only.
- When [Quick File] is selected, the password entered in "Retention Settings" is cleared and cannot be used.
- To store a file in a custom folder, the custom folder must first be created using "Document Filing Control" in the system settings (administrator). If a password has been established for a custom folder, enter the "Folder Password" in the folder selection screen.
- In Mac OS X v10.5 to 10.5.8 and v10.6 to 10.6.2, if you wish to store document filing settings in a custom folder, click the [Custom Folder] tab.
- In Mac OS 9, select [Job Handling] and then select the retention setting. (The document filing function cannot be used.)

## Automatically print all stored data

When user authentication is enabled in the system settings (administrator), all retained (stored) print jobs of a user who logs in can be printed automatically after log in. After all jobs are printed, the files are deleted.

To use the print all function, the following steps are necessary:

- "Automatically print stored jobs after login" must be enabled in the system settings (administrator) of the machine.
- At the time of retention print, in addition to user authentication information, **the user name stored in the machine** must be entered in "User Name" of the job ID in the printer driver.
  - ☞ Windows: [PRINTING WHEN THE USER AUTHENTICATION FUNCTION IS ENABLED](#) (page 3-8)
  - ☞ Macintosh: [PRINTING WHEN THE USER AUTHENTICATION FUNCTION IS ENABLED](#) (page 3-22)

**(1) Log into the machine.**

Enter your user number or login name and password in the user authentication screen of the machine.

**(2) Perform print all.**

A confirmation prompt will appear. Touch the [OK] key. The print files stored in the quick file folder, main folder, and custom folder will be printed automatically and then deleted.

Files with a password and files that are protected by the document filing function of the machine will not be printed. Files in a folder (excluding My Folder) that has a password will also not be printed.

**If you do not wish to "print all"...**  
Touch the [Cancel] key in step (2).



# PRINTING WITHOUT THE PRINTER DRIVER

When you do not have the printer driver installed on your computer, or when the software application used to open a file that you wish to print is not available, you can print directly to the machine without using the printer driver. The file types (and corresponding extensions) that can be printed directly are shown below.

File Type	TIFF	JPEG	PCL	PDF/ Encrypted PDF	PS	XPS
Extension	tiff, tif	jpeg, jpg, jpe, jfif	pcl	pdf	ps	xps

-  • To print XPS files, the XPS expansion kit must be installed.
- Depending on the file type, it may not be possible to print some files in the above table.

---



---

## DIRECTLY PRINTING FROM THE MACHINE

A file on an FTP server, in a network folder or in a USB memory device connected to the machine can be selected and printed from the operation panel of the machine without using the printer driver.

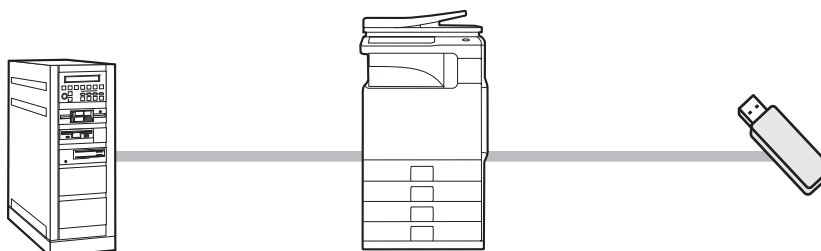

# DIRECTLY PRINTING A FILE ON AN FTP SERVER

When an FTP server is configured in the machine's Web pages, you can specify and print a file on the FTP server from the operation panel of the machine. This saves you the trouble of downloading the file and printing it from a computer. For the procedure for accessing the Web pages, see the Start Guide.

 To configure FTP server settings, click [Application Settings] and then [Setting for Print from the MFP(FTP)] in the Web page menu. (Administrator rights are required.) Up to 20 FTP servers can be configured.

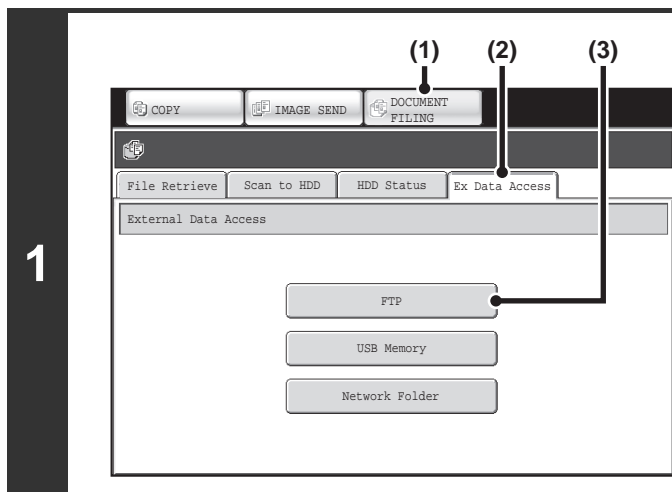

## Access the FTP server.

- (1) Touch the [DOCUMENT FILING] key.
- (2) Touch the [Ex Data Access] tab.
- (3) Touch the [FTP] key.

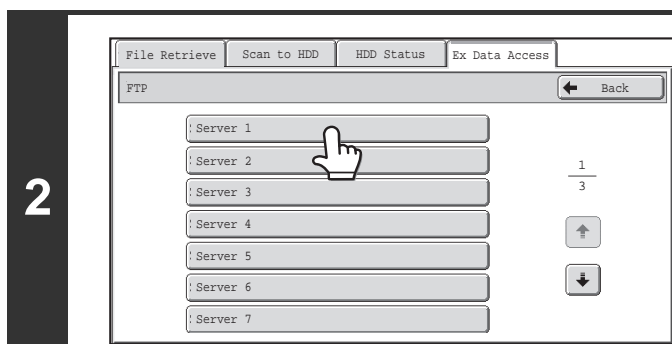

The [FTP] key cannot be touched when any FTP server has not been configured.



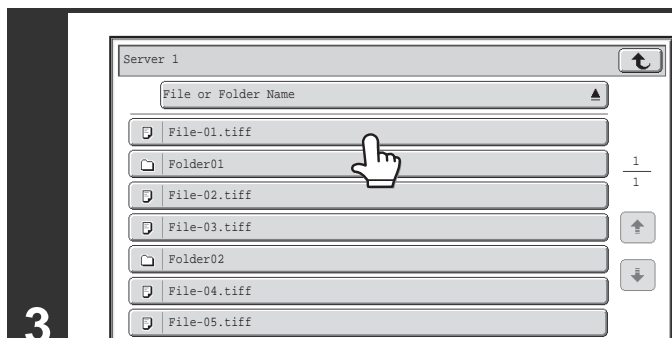

## Touch the key of the FTP server that you wish to access.



## Touch the key of the file that you wish to print.

- The  icon appears to the left of keys of files that can be printed.
- The  icon is displayed to the left of keys of folders on the FTP server. To display the files and folders in a folder, touch the key of the folder.

-  • A total of 100 keys of files and folders can be displayed.
- Touch the  key to move up one folder level.
- When you move down a folder level by touching a folder key, the  key appears in the top right corner of the screen. Touch this key to return to the file or folder name selection screen.
- Touch the [File or Folder Name] key to change the order of the files and folders displayed on the screen. The order switches between ascending order and descending order each time you touch the key.

4

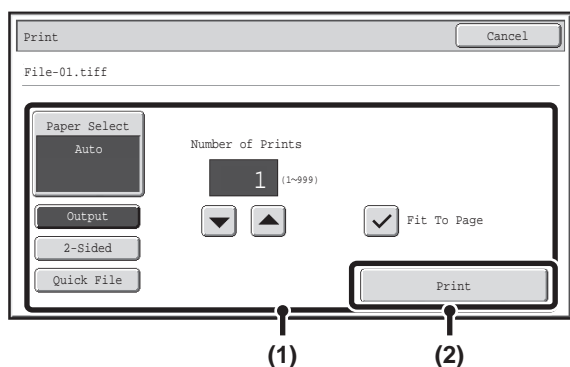

**Print the selected file.**

**(1) Select print conditions.**

If you selected a file (PCL, PS, or XPS) in step 3 that includes print settings, the settings will be applied.

**(2) Touch the [Print] key.**

Printing begins. When the message appears in the touch panel, touch the [OK] key.

When you select a PDF file that has a password, you must enter the password in the job status screen to begin printing. [PRINTING AN ENCRYPTED PDF FILE](#) (page 3-67)

## DIRECTLY PRINTING A FILE IN USB MEMORY

A file in a USB memory device connected to the machine can be printed from the operation panel of the machine without using the printer driver. When the printer driver of the machine is not installed on your computer, you can copy a file into a commercially available USB memory device and connect the device to the machine to print the file directly.

1

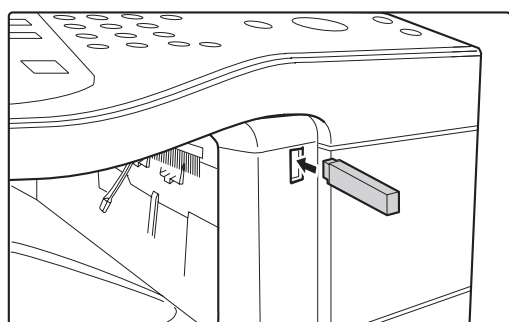

**Connect the USB memory device to the machine.**

Use a FAT32 USB memory with a capacity of no more than 32 GB.

2

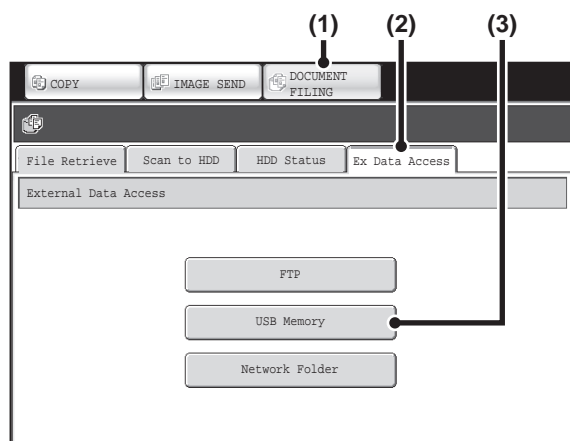

**Access the USB memory device.**

**(1) Touch the [DOCUMENT FILING] key.**

**(2) Touch the [Ex Data Access] tab.**

**(3) Touch the [USB Memory] key.**

3

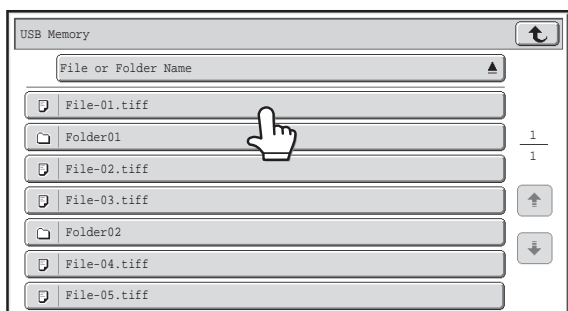

**Touch the key of the file that you wish to print.**

- The icon appears to the left of keys of files that can be printed.
- The icon is displayed to the left of keys of folders in the USB memory. To display the files and folders in a folder, touch the key of the folder.



- A total of 100 keys of files and folders can be displayed.
- Touch the key to move up one folder level.
- When you move down a folder level by touching a folder key, the key appears in the top right corner of the screen. Touch this key to return to the file or folder name selection screen.
- Touch the [File or Folder Name] key to change the order of the files and folders displayed on the screen. The order switches between ascending order and descending order each time you touch the key.

4

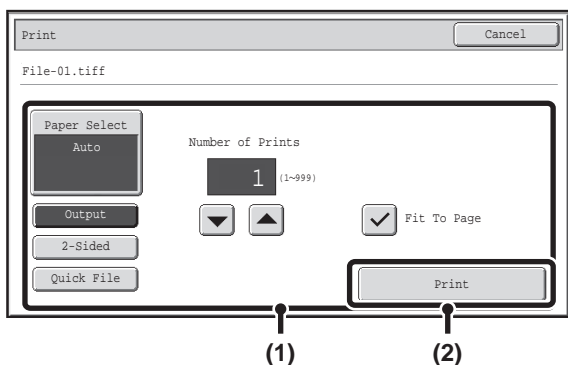

**Print the selected file.**

**(1) Select print conditions.**

If you selected a file (PCL, PS, or XPS) in step 3 that includes print settings, the settings will be applied.

**(2) Touch the [Print] key.**

Printing begins after the selected file is transferred. When the message appears in the touch panel, touch the [OK] key.



**To cancel printing...**

To cancel printing while the file is being transferred, touch the [Cancel] key in the message screen that appears in the touch panel.

5

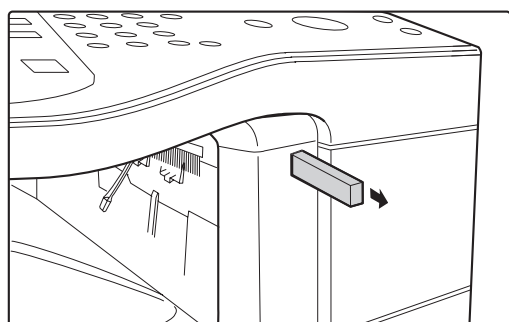

**Remove the USB memory device from the machine.**



When you select a PDF file that has a password, you must enter the password in the job status screen to begin printing.

[PRINTING AN ENCRYPTED PDF FILE](#) (page 3-67)

# DIRECTLY PRINTING A FILE IN A NETWORK FOLDER

You can use the machine's operation panel to select and print a file on a server or in a shared folder of an individual's computer on the same network as the machine.

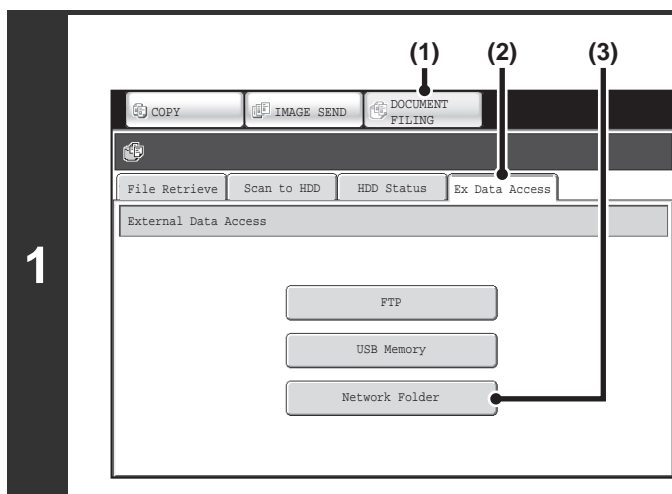

## Access the network.

- (1) Touch the [DOCUMENT FILING] key.
- (2) Touch the [Ex Data Access] tab.
- (3) Touch the [Network Folder] key.

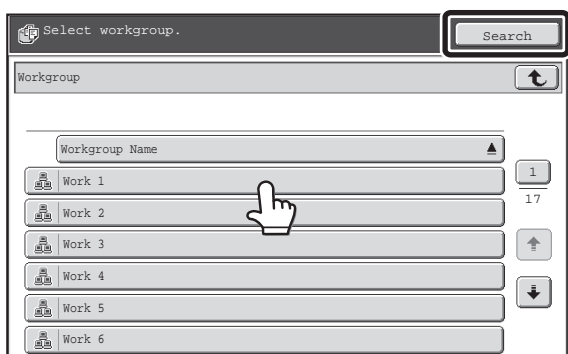

### Access the network folder.

(1) Touch the key of the workgroup that you wish to access.

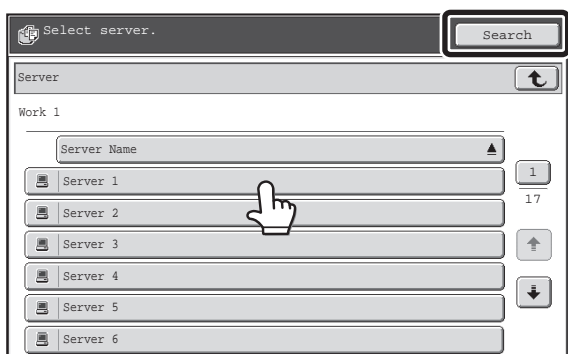

(2) Touch the key of the server or computer that you wish to access.

If a screen appears prompting you to enter a user name and password, check with your server administrator and enter the appropriate user name and password.

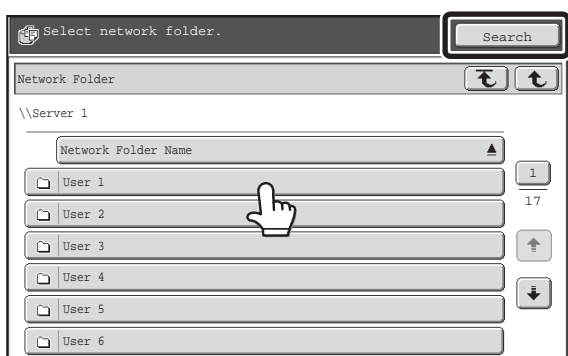

(3) Touch the key of the network folder.



- You can touch the [Search] key and enter a keyword to search for a workgroup, server, or network folder. For the procedure for entering text, see "ENTERING TEXT" (page 1-76) in "1. BEFORE USING THE MACHINE".
- Up to 100 workgroups, 100 servers, and 100 network folders can be displayed.
- Touch the key to move up one folder level.
- To return to the workgroup selection screen, touch the key.
- To change the sorting order of the displayed keys, touch the key that shows or in each screen. The order switches between ascending order and descending order each time you touch the key.
- To go to a particular page, touch the key that shows the current page number and enter the desired page number.

3



**Touch the key of the file that you wish to print.**

- The icon appears to the left of keys of files that can be printed.
- The icon is displayed to the left of keys of folders in the network folder. To display the files and folders in a folder, touch the key of the folder.



- A total of 100 keys of files and folders can be displayed.
- Touch the key to move up one folder level.
- To return to the network folder selection screen, touch the key.
- Touch the [File or Folder Name] key to change the order of the files and folders displayed on the screen. The order switches between ascending order and descending order each time you touch the key.

4

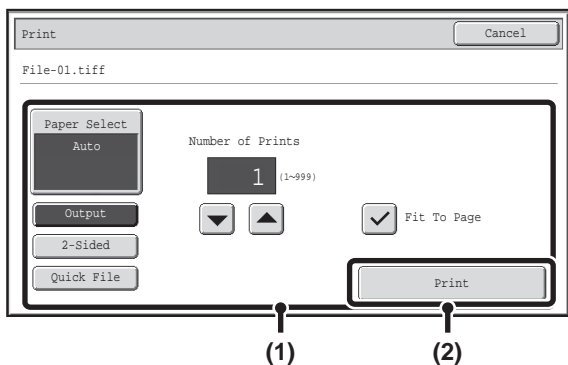

**Print the selected file.**

**(1) Select print conditions.**

If you selected a file (PCL, PS, or XPS) in step 3 that includes print settings, the settings will be applied.

**(2) Touch the [Print] key.**

Printing begins after the selected file is transferred. When the message appears in the touch panel, touch the [OK] key.



When you select a PDF file that has a password, you must enter the password in the job status screen to begin printing.

[PRINTING AN ENCRYPTED PDF FILE](#) (page 3-67)

---

---

# DIRECTLY PRINTING FROM A COMPUTER

Settings can be configured in the Web pages of the machine to enable direct printing from a computer without using the printer driver. For the procedure for accessing the Web pages, see the Start Guide.

## SUBMIT PRINT JOB

You can specify a file to be printed directly without using the printer driver.

In addition to a file on your computer, this procedure can be used to print any file that can be accessed from your computer, such as a file on another computer connected to the same network.

To directly print a file on a computer, click [Document Operations] and then [Submit Print Job] in the Web page menu.

## FTP PRINT

You can print a file from your computer by simply dragging and dropping the file onto the FTP server of the machine.

### • Configuring settings

To enable FTP Print, click [Application Settings] and then [Setting for Print from the PC] in the Web page menu, and configure the port number. (Administrator rights are required.)

### • Performing FTP Print

Type "ftp://" and then the IP address of the machine in the address bar of your computer's Web browser as shown below.

#### (Example)

ftp://192.168.1.28

Drag and drop the file that you wish to print onto the "lp" folder that appears in your Web browser. The file will automatically begin printing.



- If you printed a file (PCL, PS, or XPS) that includes print settings, the settings will be applied.
- When user authentication is enabled in the system settings (administrator) of the machine, the print function may be restricted. For more information, ask your administrator.



# E-MAIL PRINT

An e-mail account can be configured in the machine to have the machine periodically check your mail server and automatically print received e-mail attachments without using the printer driver.

## • Configuring settings

To use E-mail Print, you must first configure an e-mail account in the machine. To configure an account, click [Application Settings] and then [E-mail Print Settings] in the Web page menu. (Administrator rights are required.) For the procedure for accessing the Web pages, see the Start Guide.

## • Using E-mail Print

To print a file using E-mail Print, use your e-mail program on your computer to send the file as an attachment to the machine's e-mail address.

Control commands can be entered in the message of the e-mail to specify the number of copies and print format. Commands are entered in the format "command name=value".

As an example, the control commands include the following:

Function	Command name	Values
Copies	COPIES	1-999
Staples*1	STAPLEOPTION	NONE, ONE
Output	COLLATE	OFF, ON
2-sided print	DUPLEX	OFF, TOP, LEFT, RIGHT
Account number*2	ACCOUNTNUMBER	Number (5 to 8 digits)
File type	LANGUAGE	PCL, PCLXL, POSTSCRIPT, PDF, TIFF, JPG, XPS
Paper	PAPER	Name of available paper (LETTER, A4, etc.)
Document Filing	FILE	OFF, ON
	FOLDERNAME	Maximum of 28 characters
Quick File	QUICKFILE	OFF, ON
Fit to page	FITIMAGETOPAGE	OFF, ON

**Example**

```
COPIES=2
DUPLEX=LEFT
ACCOUNTNUMBER=11111
PAPER=LETTER
```

\*1 Only effective when a finisher is installed.

\*2 Can be omitted except when authentication is by user number.



- Enter the commands in Plain Text format. If entered in Rich Text format (HTML), the commands will have no effect.
- To receive a list of the control commands, enter the command "Config" in the e-mail message.
- If nothing is entered in the body text (message) of the e-mail, printing will take place according to the "Printer Default Settings" in the system settings. If you printed a file (PCL, PS, or XPS) that includes print settings, the settings will be applied.
- Only enter a "File type" when you are specifying a page-description language. Normally there is no need to enter a file type.

# CHECKING THE PRINT STATUS

## JOB STATUS SCREEN

The job status screen is displayed when the [JOB STATUS] key on the operation panel is pressed. The job status screen shows the status of jobs by mode. When the [JOB STATUS] key is pressed, the job status screen of the mode that was being used before the key was pressed appears.

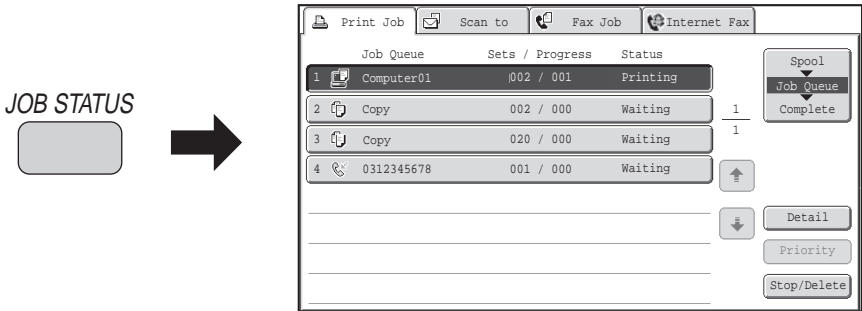

The job status display (A) is in the lower left corner of the touch panel. The job status display can be touched to display the job status screen. You can check the first four print jobs in the print queue (the job in progress and reserved jobs) in the job status display (B).

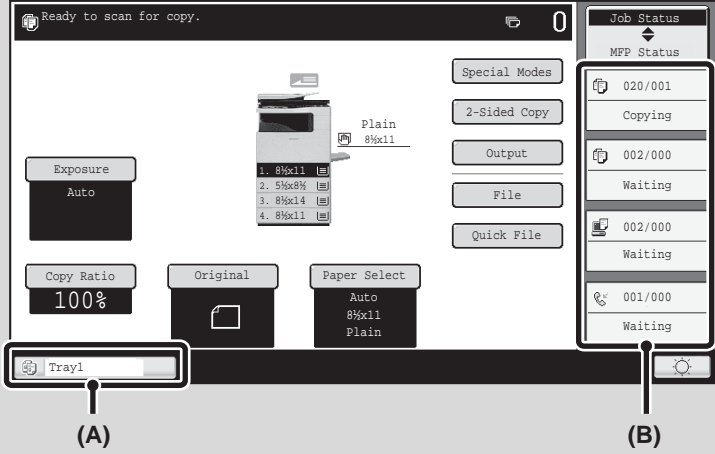

# SPOOL SCREEN/JOB QUEUE SCREEN/COMPLETED JOB SCREEN

The job status screen consists of the job queue screen that shows copy and print jobs waiting to be printed and the job currently in progress, the completed job screen that shows jobs that have been completed, and the spool screen that shows print jobs that have been spooled and encrypted PDF jobs that are waiting for a password to be entered.

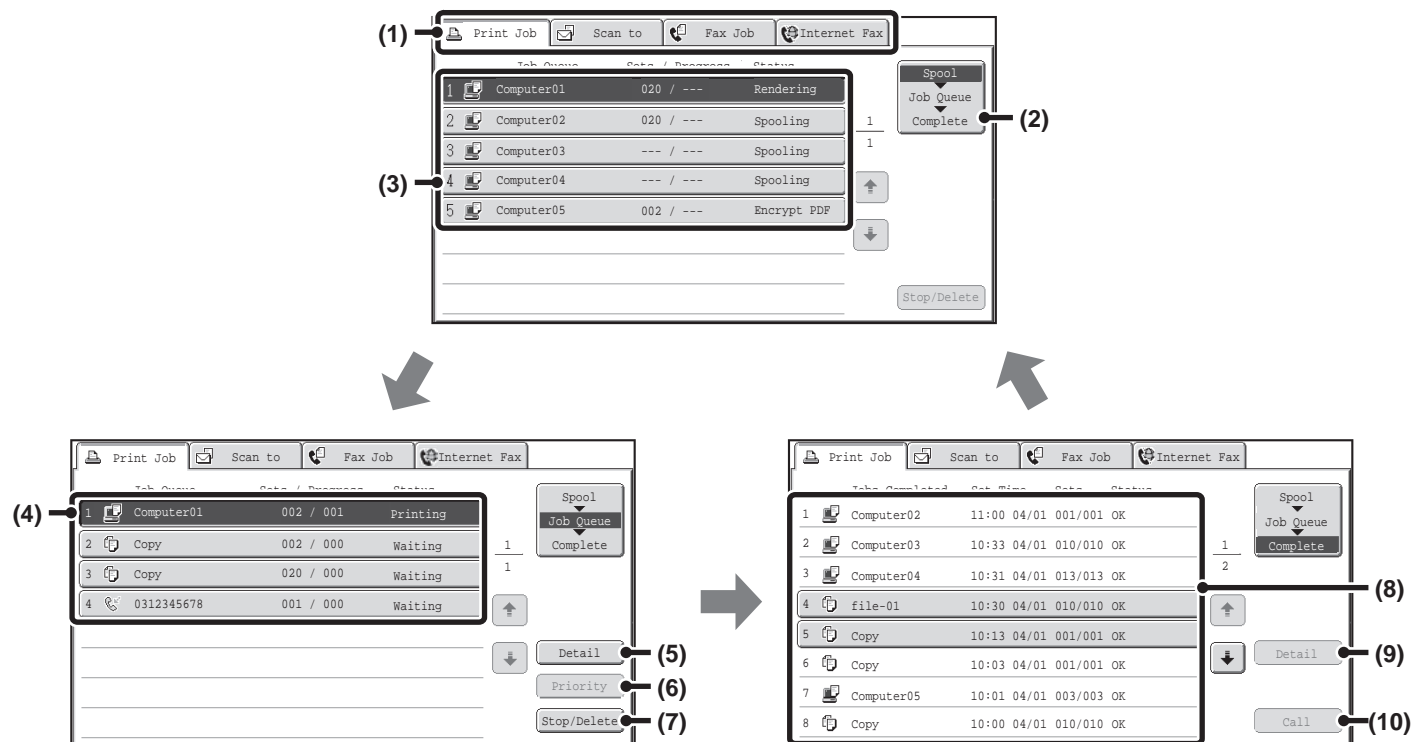

**(1) Mode select tabs**

Use these tabs to select the mode that is shown in the job status screen. The status of print jobs can be checked by touching the [Print Job] tab.

**(2) Job status screen selector key**

Touch this key to switch through the job queue screen, the completed jobs screen, and the spool screen.

**(3) Job list (spool screen)**

Spooled print jobs and encrypted PDF print jobs that require a password to be entered are displayed.

**(4) Job list (job queue screen)**

Jobs waiting to be printed appear in the job queue as keys. The jobs are printed in order from the top of the queue. Each job key shows information on the job and the current status of the job.

**(5) [Detail] key (job queue screen)**

Touch this key to display detailed information on a job.

**(6) [Priority] key**

Touch this key to give priority to a selected job.

**(7) [Stop/Delete] key**

Touch this key to stop or delete a selected job.

**(8) Job list (completed jobs screen)**

This shows up to 99 completed jobs. The result (status) of each completed job is shown.

**(9) [Detail] key (completed jobs screen)**

When a job is shown as a key in the job list, the [Detail] key can be touched to show detailed information on the job.

**(10) [Call] key**

Touch this key to retrieve and use a print job stored using the document filing function.

## Job key display

Each job key shows the position of the job in the job queue and the current status of the job.

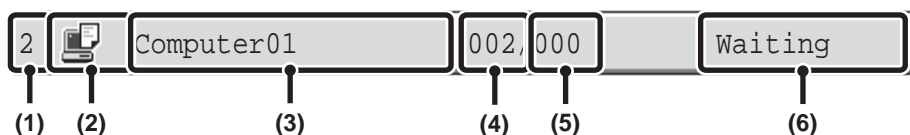

**(1) Indicates the number (position) of the job in the job queue.**

When the job currently being printed is finished, the job moves up one position in the job queue. This number does not appear in keys in the completed jobs screen.

**(2) Mode icon**

The  icon appears when the job is a print job.

**(3) User name**

The computer login name of the user will appear in the print job. A "User Name" can be entered in the printer driver to display the name of the user who executed the job.

**(4) Number of sets entered**

This shows the number of sets specified.

**(5) Number of completed sets**

This shows the number of sets completed. "000" appears while the job is waiting in the job queue.

**(6) Status**

Shows the job status.

Message	Status
"Printing"	Printing is in progress.
"Waiting"	The job is waiting to be executed.
"Toner Empty"	The toner cartridge is out of toner. Replace the toner cartridge with a new cartridge.
"Paper Empty"	The paper used for the job has run out. Add paper or change to a different paper tray.
"Limit"	The printing page limit has been exceeded. Check with the administrator of the machine.
"Error"	An error occurred while the job was being executed. Clear the error condition.
"Rendering"	Analyzing print data.
"Spooling"	Print data is being received or a job is waiting for analysis after being spooled.
"Encrypt PDF"	Upon analysis, if a spooled job is found to be an encrypted PDF, it changes to the password entry wait state.

# PRINTING AN ENCRYPTED PDF FILE

Encrypted PDF is used to protect a PDF file by requiring the entry of a password to print or edit the file. To directly print an encrypted PDF file on an FTP server or in a USB memory device, etc. connected to the machine, follow the steps below to enter the password and begin printing.

1

*JOB STATUS*

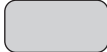

**Press the [JOB STATUS] key.**

2

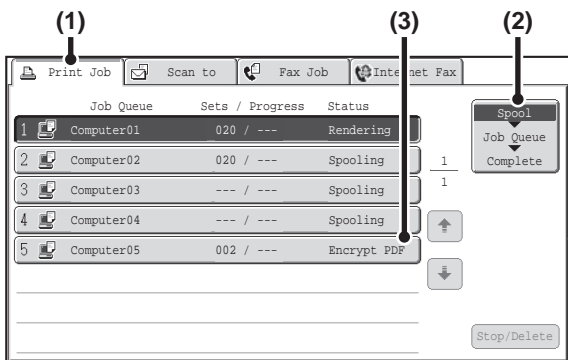

**Select the encrypted PDF print job.**

(1) Touch the [Print Job] tab.

(2) Change the print job status mode to [Spool].  
Touch this key to change modes. The selected mode will be highlighted.

(3) Touch the print job key of the PDF file that has the password.

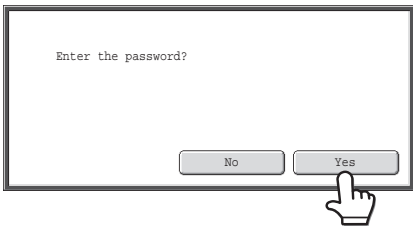

3



**Touch the [Yes] key.**

A text entry screen appears. Enter the password (32 characters or less) and touch the [OK] key. The print job is released and moved to the [Job Queue].

 When both a master password and a user password (which is used to open the file) have been set, enter the master password.

-  • To print an encrypted PDF file using the printer driver, enter the password when opening the file on your computer.
-  • Printing is not possible if you do not know the password for an encrypted PDF file. To delete a spooled print job, touch the [No] key in the screen of step 3 and touch the [Stop/Delete] key.
-  • Encrypted PDF versions that can be directly printed are 1.6 (Adobe® Acrobat® 7.0) and earlier.

# GIVING A PRINT JOB PRIORITY/CANCELING A PRINT JOB

## GIVING A PRINT JOB PRIORITY

When the machine is busy copying or printing a received fax or other job, you can give priority to a print job that is waiting to be printed and print it ahead of the other jobs.

1

JOB STATUS

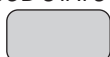

Press the [JOB STATUS] key.

2

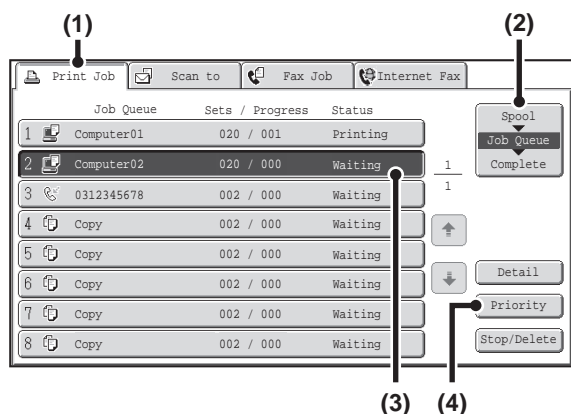

Give the desired job priority.

- (1) Touch the [Print Job] tab.
- (2) Change the print job status mode to [Job Queue].  
Touch this key to change modes. The selected mode will be highlighted.
- (3) Touch the key of the print job to which you want to give priority.
- (4) Touch the [Priority] key.  
The job being printed stops and the job selected in (3) is printed.



To check print information on the selected job, touch the [Detail] key.

# CANCELING A PRINT JOB

A job being printed, a job waiting to be printed, or a spooled job can be canceled.

1

JOB STATUS



Press the [JOB STATUS] key.

2

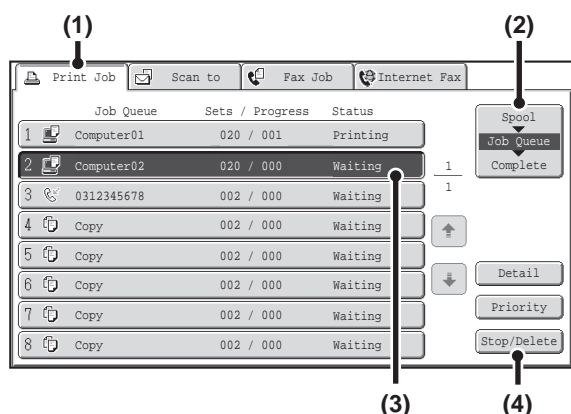

## Cancel the job.

- (1) Touch the [Print Job] tab.
- (2) Change the print job status mode to [Spool] or [Job Queue].  
Touch this key to change modes. The selected mode will be highlighted.
- (3) Touch the key of the print job that you wish to cancel.
- (4) Touch the [Stop/Delete] key.
- (5) A message appears to confirm the cancellation. Touch the [Yes] key.

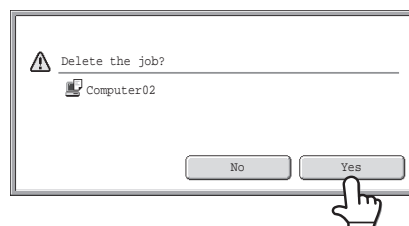

The selected job key is deleted and printing is canceled.

It is also possible to cancel printing with the [STOP] key (⏹) on the operation panel. When the [STOP] key (⏹) is pressed, a message will appear asking you if you want to cancel the job.

**If you do not want to cancel the selected print job...**  
Touch the [No] key in step (5).

# CHANGING TO ANOTHER PAPER SIZE AND PRINTING WHEN PAPER RUNS OUT

If printing stops because the machine ran out of paper, or if the size of paper specified in the printer driver is not loaded in the machine, a message will appear in the touch panel. Printing will begin automatically when the [OK] key is touched and paper is loaded in the machine. If you wish to print on paper in another tray because the desired size of paper is not immediately available, follow the steps below.

1

*JOB STATUS*



**Press the [JOB STATUS] key.**

2

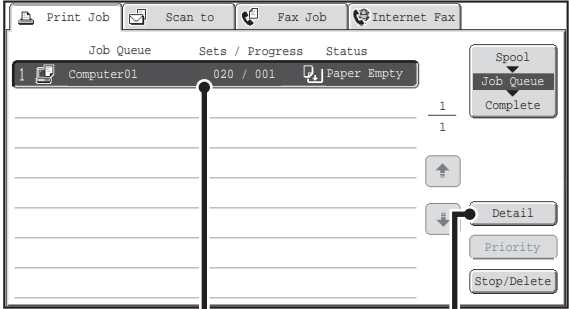

**Display details on the print job for which there is no paper.**

- (1) Touch the key of the job for which "Paper Empty" appeared.
- (2) Touch the [Detail] key.

3

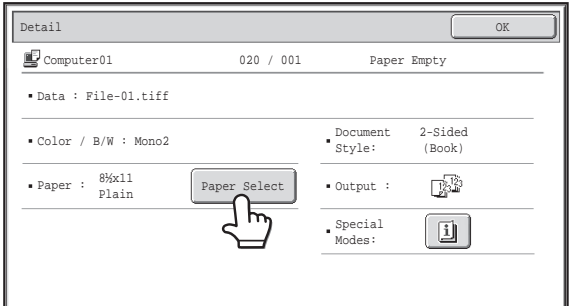

**Touch the [Paper Select] key.**

4

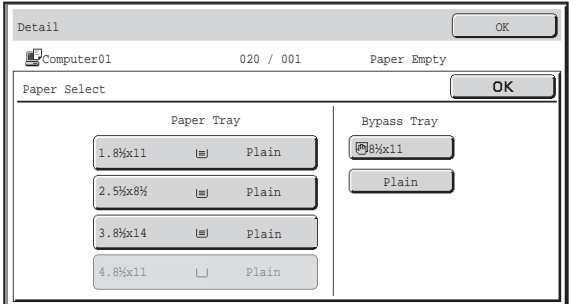

**Touch the key of the tray that has the paper you wish to use.**

Printing begins.

 If you changed to a different paper size, printing may not take place correctly; for example part of the text or image may run off the paper.



# APPENDIX

## PRINTER DRIVER SPECIFICATION LIST

Available functions and output results may vary depending on the type of printer driver being used.

Function		PCL6	PCL5e	PS	Windows PPD*1	Macintosh PPD*1	
Frequently used functions	Copies	1-999	1-999	1-999	1-999	1-999	
	Orientation	Yes	Yes	Yes	Yes	Yes	
	N-Up	Number of pages	2,4,6,8,9,16	2,4,6,8,9,16	2,4,6,8,9,16	2,4,6,9,16	2,4,6,9,16
		Order	Selectable	Selectable	Selectable	Selectable	Selectable
		Border	On/Off	On/Off	On/Off	Yes	Selectable
	2-Sided Print	Yes	Yes	Yes	Yes	Yes	
	Fit To Page	Yes	Yes	Yes	No	Yes*2	
	Binding Edge	Selectable	Selectable	Selectable	No	Yes	
Staple*5	Yes	Yes	Yes	Yes	Yes		
Paper	Paper Size	Yes	Yes	Yes	Yes	Yes	
	Custom Paper	8 size	8 size	8 size	Yes	Yes	
	Paper Selection	Yes	Yes	Yes	Yes	Yes	
	Output tray	Yes	Yes	Yes	Yes	Yes	
Convenient printer functions	Pamphlet	Yes	Yes	Yes	Yes	Yes	
	Margin Shift	0 inch to 1.2 inch	0 inch to 1.2 inch	0 inch to 1.2 inch	Yes	Yes	
	Poster Printing	Yes	No	Yes	No	No	
	Rotate 180 degrees	Yes	Yes	Yes	Yes	Yes	
	Zoom/XY-Zoom	Yes*4	Yes*4	Yes	Yes*4	Yes*4	
	Line Width Settings	Yes	No	No	No	No	
	Mirror Image	No	No	Yes	Yes	Yes*5	
Special functions	Different Paper	Yes	Yes	Yes	No	Yes*6, 7	
	Transparency Inserts	Yes	Yes	Yes	No	Yes	
	Carbon Copy	Yes	Yes	Yes	No	No	
	Chapter Inserts	Yes	No	No	No	No	
	Page Interleave	Yes	No	No	No	No	
	Retention	Yes	Yes	Yes	No	Yes	
	Document Filing	Yes	Yes	Yes	No	Yes*8	
Image adjusting function	Image Adjustment	Yes	Yes	No	No	No	
	Text To Black/ Vector To Black	Yes	Yes	Yes	No	No	

Function		PCL6	PCL5e	PS	Windows PPD*1	Macintosh PPD*1
Functions to combine text and images	Watermark	Yes	Yes	Yes	Yes	Yes
	Image Stamp	Yes	No	Yes	No	No
	Overlay	Yes	Yes	Yes	No	No
Image Quality	Print Mode	Normal/ High Quality/ Fine	No	Normal/ High Quality/ Fine	Normal/ High Quality/ Fine	Normal/ High Quality/ Fine
	Graphics Mode Selection	Yes	Yes	No	No	No
	Toner Save*9	Yes	No	Yes	Yes	Yes
Font	Resident font	80 fonts	80 fonts	136 fonts	136 fonts	35 fonts
	Selectable download font	bitmap, TrueType, Graphics	bitmap, TrueType, Graphics	bitmap, TrueType, Type1	bitmap, TrueType, Type1	No*10
Other functions	Auto Configuration	Yes	Yes	Yes	No	Yes*11
	User Authentication	Yes	Yes	Yes	No	Yes

\*1 The specifications of each function in Windows PPD and Macintosh PPD vary depending on the operating system version and the software application.

\*2 Only Mac OS X v10.4.11, v10.5 to 10.5.8 and v10.6 to 10.6.2 can be used.

\*3 Can be used when a finisher is installed.

\*4 The horizontal and vertical proportion cannot be set separately.

\*5 Only Mac OS 9.0 to 9.2.2 can be used.

\*6 Only covers can be inserted.

\*7 Cannot be used in Mac OS X v10.2.8 or v10.3.9.

\*8 Cannot be used in Mac OS 9.0 to 9.2.2.

\*9 This setting may not operate in some software applications and operating systems.

\*10 True Type and Type1 can be selected in some versions of LaserWriter.

\*11 Cannot be used in Mac OS X v10.2.8.

# PRINTER SPECIFICATIONS

<b>Type</b>	Built-in	
<b>Continuous printing speed</b>	40 pages/min (When printing same document continuously on 8-1/2"x11" (A4) plain paper in non-offset mode, excluding processing time.)	
<b>Printing resolution</b>	600x600 dpi / 1200x1200 dpi	
<b>Printer driver type</b>	PCL5e, PCL6, PostScript 3 compatible*1, XPS*3	
<b>Supported protocols</b>	TCP/IP, IPX/SPX, NetBEUI, EtherTalk*1	
<b>Supported client PC operating systems</b>	See "VERIFYING SYSTEM REQUIREMENTS" in the Start Guide.	
<b>Fonts</b>	PCL5e, PCL6	80 European fonts, 28 barcode fonts*2, 1 bitmap font
	PostScript 3 compatible*1	136 European fonts
<b>Interface port</b>	LAN connectivity: 10Base-T / 100Base-TX / 1000Base-T USB connectivity: Supports USB 2.0 (Hi speed)	
<b>Memory</b>	Standard system memory: 512 MB Expansion memory: 1GB*4	
<b>Print area</b>	Entire page excluding margin of 1/6" (4.2mm) at each edge. The actual print area may vary depending on the printer driver and the software application.	

\*1 When the machine is used as a PostScript printer.

\*2 Barcode font kit is required.

\*3 When the XPS expansion kit is installed.

\*4 Required when there is insufficient memory to handle certain print data. Must be used when the XPS expansion kit is installed.

# CHAPTER 4

# FACSIMILE

This chapter provides detailed explanations of the procedures for using the fax function.

To use the fax function, the facsimile expansion kit must be installed.

## BEFORE USING THE MACHINE AS A FAX

<b>PREPARATIONS FOR FAX</b> .....	<b>4-4</b>
• CONNECTION TO THE TELEPHONE LINE .....	4-4
• SETTING THE TELEPHONE LINE TYPE .....	4-5
• MAKE SURE THE MAIN POWER SWITCH IS IN THE "ON" POSITION .....	4-5
• CHECKING THE DATE AND TIME .....	4-6
• STORING THE SENDER FAX NUMBER .....	4-6
<b>BASE SCREEN OF FAX MODE</b> .....	<b>4-7</b>
• BASE SCREEN OF FAX MODE .....	4-8
• ADDRESS BOOK SCREEN .....	4-11
• CHANGING THE DISPLAY OF ONE-TOUCH KEYS IN THE ADDRESS BOOK SCREEN .....	4-12
<b>FAX TRANSMISSION SEQUENCE</b> .....	<b>4-14</b>

## ENTERING DESTINATIONS

<b>ENTERING A FAX NUMBER WITH THE NUMERIC KEYS</b> .....	<b>4-16</b>
<b>RETRIEVING A FAX NUMBER FROM THE ADDRESS BOOK</b> .....	<b>4-17</b>
• RETRIEVING A STORED DESTINATION .....	4-18
• CHECKING AND DELETING ENTERED DESTINATIONS .....	4-19
<b>USING A SEARCH NUMBER TO RETRIEVE A DESTINATION</b> .....	<b>4-20</b>
<b>RETRIEVING A DESTINATION FROM A GLOBAL ADDRESS BOOK</b> .....	<b>4-21</b>
<b>USING THE RESEND FUNCTION</b> .....	<b>4-23</b>
<b>CHAIN DIALING</b> .....	<b>4-24</b>

## BASIC TRANSMISSION METHODS

<b>TRANSMISSION METHODS</b> .....	<b>4-25</b>
• PLACEMENT ORIENTATION OF THE ORIGINAL .....	4-28
• WHEN THE LINE IS BUSY .....	4-28
• WHEN A COMMUNICATION ERROR OCCURS .....	4-28
• FAX DESTINATION CONFIRMATION MODE .....	4-29
<b>USING THE AUTOMATIC DOCUMENT FEEDER FOR TRANSMISSION</b> .....	<b>4-30</b>
• USING THE AUTOMATIC DOCUMENT FEEDER TO SEND A FAX IN DIRECT TRANSMISSION MODE .....	4-32
<b>USING THE DOCUMENT GLASS FOR TRANSMISSION</b> .....	<b>4-34</b>
• USING THE DOCUMENT GLASS TO SEND A FAX IN DIRECT TRANSMISSION MODE .....	4-36
<b>TRANSMISSION USING THE SPEAKER</b> .....	<b>4-38</b>
<b>SENDING THE SAME FAX TO MULTIPLE DESTINATIONS (Broadcast Transmission)</b> .....	<b>4-39</b>
<b>SENDING A FAX DIRECTLY FROM A COMPUTER (PC-Fax)</b> .....	<b>4-44</b>
<b>IMAGE SETTINGS</b> .....	<b>4-45</b>
• AUTOMATICALLY SCANNING BOTH SIDES OF AN ORIGINAL (2-Sided Original) .....	4-46
• SPECIFYING THE SCAN SIZE AND SEND SIZE .....	4-47
• CHANGING THE EXPOSURE .....	4-56
• CHANGING THE RESOLUTION .....	4-57
<b>CHECKING THE IMAGE TO BE TRANSMITTED (Preview)</b> .....	<b>4-58</b>
• PREVIEW CHECK SCREEN .....	4-59



**FAX RECEPTION**

<b>RECEIVING FAXES</b> .....	4-60
• RECEIVING A FAX .....	4-61
• RECEIVING A FAX MANUALLY .....	4-62
<b>PRINTING A PASSWORD-PROTECTED FAX (Hold Setting For Received Data Print)</b> .....	4-63
<b>CHECKING THE IMAGE BEFORE PRINTING</b> ...	4-64
• IMAGE CHECK SCREEN .....	4-65
<b>FORWARDING RECEIVED FAXES (Fax Data Forward)</b> .....	4-66
<b>FORWARDING RECEIVED FAXES TO A NETWORK ADDRESS (Inbound Routing Settings)</b> .....	4-67
• CONFIGURING INBOUND ROUTING SETTINGS .....	4-67

<b>SPECIAL MODES</b> .....	4-71
<b>STORING FAX OPERATIONS (Program)</b> .....	4-73
<b>ERASING PERIPHERAL SHADOWS ON THE IMAGE (Erase)</b> .....	4-75
<b>SENDING A FAX AT A SPECIFIED TIME (Timer)</b> .....	4-77
<b>SENDING BOTH SIDES OF A CARD AS A SINGLE PAGE (Card Shot)</b> .....	4-79
<b>SENDING A LARGE NUMBER OF PAGES (Job Build)</b> .....	4-82
<b>FAXING THIN ORIGINALS (Slow Scan Mode)</b> ...	4-84
<b>CHECKING THE NUMBER OF SCANNED ORIGINAL SHEETS BEFORE TRANSMISSION (Original Count)</b> .....	4-86
<b>SENDING BUSINESS CARDS (Business Card Scan)</b> .....	4-88
<b>CHANGING THE PRINT SETTINGS FOR THE TRANSACTION REPORT (Transaction Report)</b> .....	4-89
<b>ADDING YOUR SENDER INFORMATION TO FAXES (Own number sending)</b> .....	4-91
• TEMPORARILY CHANGING THE SENDER INFORMATION (Own Name Select) .....	4-92
<b>CALLING A FAX MACHINE AND INITIATING RECEPTION (Polling)</b> .....	4-93
• INITIATING POLLING RECEPTION MANUALLY .....	4-95

<b>SENDING A FAX WHEN ANOTHER MACHINE POLLS YOUR MACHINE (Polling Memory)</b> .....	4-96
• RESTRICTING POLLING ACCESS (Polling security) .....	4-96
• SCANNING A DOCUMENT INTO POLLING MEMORY .....	4-97
• CHECKING THE DOCUMENT IN THE PUBLIC BOX .....	4-99
• DELETING A DOCUMENT FROM THE PUBLIC BOX .....	4-100

**PERFORMING F-CODE COMMUNICATION**

<b>F-CODE COMMUNICATION</b> .....	4-101
• HOW F-CODES WORK .....	4-101
• CREATING MEMORY BOXES IN THE MACHINE FOR F-CODE COMMUNICATION .....	4-102
• F-CODE DIALING .....	4-102
<b>CONFIDENTIAL COMMUNICATION USING F-CODES</b> .....	4-103
• F-CODE CONFIDENTIAL TRANSMISSION .....	4-104
• CHECKING FAXES RECEIVED BY F-CODE CONFIDENTIAL RECEPTION ...	4-105
<b>POLLING RECEPTION USING F-CODES</b> .....	4-107
<b>POLLING MEMORY TRANSMISSION USING F-CODES</b> .....	4-109
• SCANNING A DOCUMENT INTO A MEMORY BOX FOR F-CODE POLLING TRANSMISSION .....	4-109
• CHECKING THE DOCUMENT IN THE F-CODE MEMORY POLLING BOX .....	4-112
• DELETING A DOCUMENT STORED FOR F-CODE POLLING TRANSMISSION .....	4-113
<b>RELAY REQUEST TRANSMISSION USING F-CODES</b> .....	4-114
<b>RELAY BROADCAST TRANSMISSION USING F-CODES</b> .....	4-116



**USING AN EXTENSION PHONE**

**CONNECTING AND USING AN EXISTING PHONE (Extension Phone Connection) . . . . . 4-117**

- RECEIVING A FAX AFTER ANSWERING A CALL ON THE EXTENSION PHONE (Remote Reception) . . . . . 4-118
- MAKING AND RECEIVING PHONE CALLS . . . . . 4-118

**CHECKING THE STATUS OF FAX JOBS**

**JOB STATUS SCREEN . . . . . 4-119**

- JOB QUEUE SCREEN AND COMPLETED JOB SCREEN. . . . . 4-120
- OPERATION WHEN A JOB IN THE JOB QUEUE IS COMPLETED. . . . . 4-123
- CHECKING A RESERVED JOB OR THE JOB IN PROGRESS. . . . . 4-124
- CHECKING COMPLETED JOBS. . . . . 4-125

**CANCELING A FAX IN PROGRESS OR A RESERVED FAX . . . . . 4-126**

**GIVING PRIORITY TO A RESERVED FAX JOB. . . . . 4-127**

**CHECKING THE ACTIVITY LOG (Image Sending Activity Report) . . . . . 4-128**

- IMAGE SENDING ACTIVITY REPORT . . . . . 4-128
- INFORMATION APPEARING IN THE RESULT COLUMN. . . . . 4-129

**FACSIMILE SPECIFICATIONS . . . . . 4-130**

# BEFORE USING THE MACHINE AS A FAX

This section provides information that you should know before using the machine as a fax machine.

---

---

## PREPARATIONS FOR FAX

To use the machine as a fax, the telephone line must be connected and the type of line must be set.

### CONNECTION TO THE TELEPHONE LINE

Be sure to use the provided telephone line cord to connect the machine to the wall telephone jack. Connect the end of the line cord that has the core to the "LINE" jack on the machine. Insert the other end (the end without the core) into a telephone line jack.

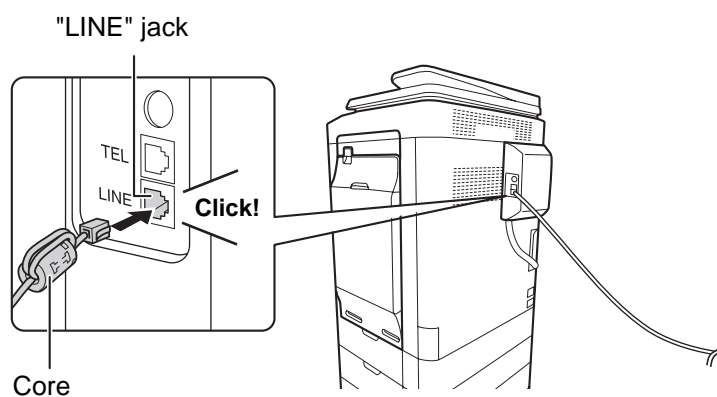

Insert the end of the cord with the core into the "LINE" jack.

## SETTING THE TELEPHONE LINE TYPE

The machine's dial mode setting must be set to the type of telephone line you are using.

If the setting is not correct, dialing will not be possible.

Touch the [Auto Select] key in "Dial Mode Setting" in the system settings (administrator). The machine will automatically set the dial mode to the type of line you are using.

You can also set the "Dial Mode Setting" manually.



After setting the dial mode, do not change the setting unless you have a specific reason for changing it.

## MAKE SURE THE MAIN POWER SWITCH IS IN THE "ON" POSITION

When the main power indicator on the operation panel is lit, the main power is on.

If the main power indicator light is not lit, the main power is "off". Switch the main power switch to the "on" position and press the [POWER] key (⏻) on the operation panel.

If the fax function will be used, and in particular if reception or timer transmission will take place at night, always keep the main power switch in the "on" position.



When the [POWER SAVE] key (⏻) indicator light is blinking, the machine is in auto power shut-off mode. If the [POWER SAVE] key (⏻) is pressed when the indicator is blinking, the indicator will turn off and the machine will return to the ready state after a brief interval.

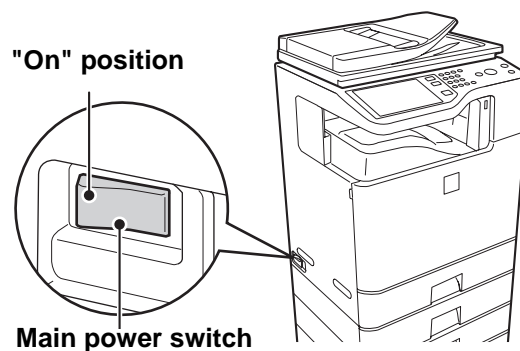
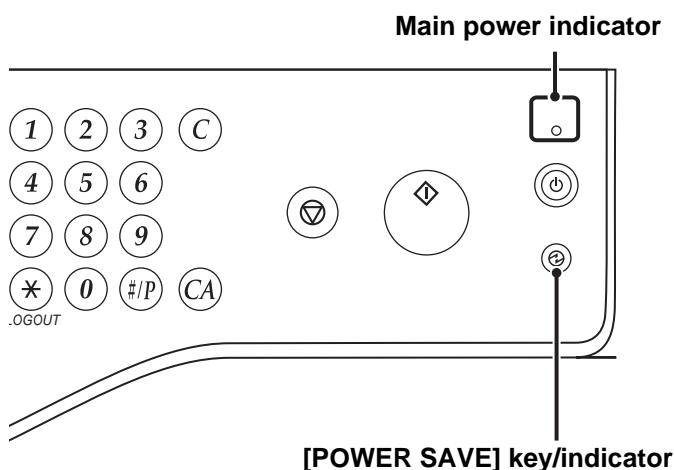



## CHECKING THE DATE AND TIME

Verify that the correct date and time are set in the machine.

The date and time are set in the system settings of the machine. When the [SYSTEM SETTINGS] key is pressed, the system settings menu screen appears on the touch panel. Select [Default Settings], [Clock], and [Clock Adjust], and set the year, month, day, hour, and minute.

 If "Disabling of Clock Adjustment" has been enabled in the system settings (administrator), the date and time cannot be set.

## STORING THE SENDER FAX NUMBER

Store the user name and fax number in "Sender Data Registration".

Be sure to configure this information, as it is required for communication.

 **System Settings (Administrator): Sender Data Registration**  
Use this setting to program the sender name and sender fax number.

# BASE SCREEN OF FAX MODE

To use the fax function, select settings and operations in the base screen of fax mode. To display the base screen of fax mode, touch the [IMAGE SEND] key and then touch the [Fax] tab.

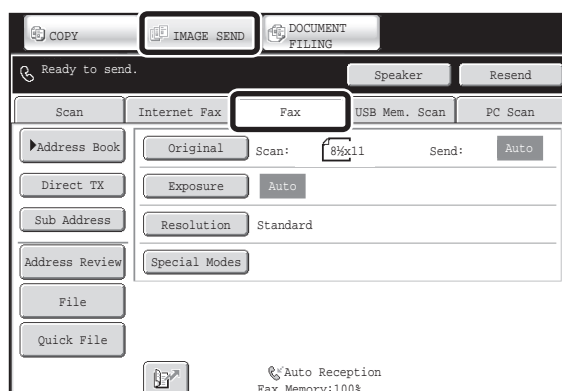

This screen only appears when the fax function and Internet fax function have been installed. The contents of the screen will vary depending on the devices that are installed.

Each of the other modes that can be displayed by touching the [IMAGE SEND] key (scan, Internet fax, USB memory, PC scan and data entry modes) also have base screens.

Transmission destinations can be stored in one-touch keys in the address book and retrieved from the address book screen when you need to use them. The address book is shared by fax mode, scan mode, Internet fax mode and data entry mode.

To display the address book screen, touch the [Address Book] key in the base screen. To display the base screen, touch the [Condition Settings] key in the address book screen. This chapter refers to the base screen of fax mode as the "base screen".

## Base screen of fax mode

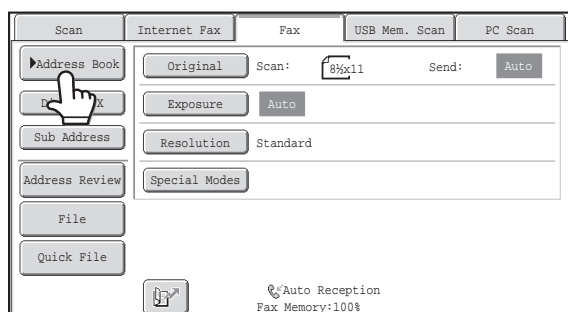

## Address book screen

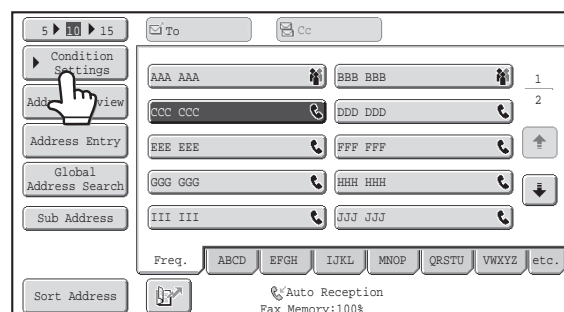

The procedures in this chapter begin from the base screen of fax mode.



### System Settings (Administrator): Default Display Settings

One of the following screens can be selected for the initial screen that appears when the [IMAGE SEND] key is touched.

- Base screen of each mode (scan, Internet fax, fax, or data entry mode)
- Address book screen

# BASE SCREEN OF FAX MODE

This screen is used to select settings and operations in fax mode.

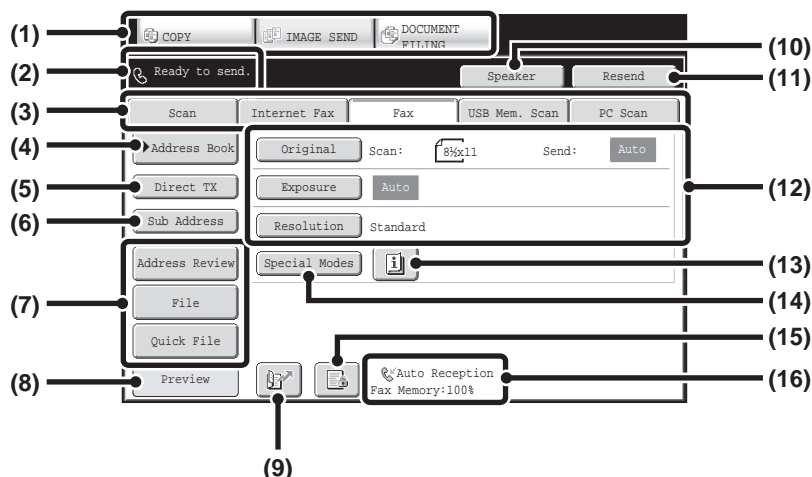

## (1) Mode select keys

Use these keys to switch between copy, image send, and document filing modes.

To switch to fax mode, touch the [IMAGE SEND] key.

## (2) This shows various messages and the destinations that have been entered.

The  icon on the left indicates fax mode.

## (3) Send mode tabs

Use these keys to change the mode of the image send function.

Tabs of modes that cannot be used because the appropriate options are not installed do not appear.

If the [Fax] tab does not appear, touch the  tab to move the screen.

[BASE SCREEN OF FAX MODE](#) (page 4-7)

## (4) [Address Book] key

Touch this key to dial using a one-touch key or group key. When the key is touched, the address book screen appears.

[RETRIEVING A FAX NUMBER FROM THE ADDRESS BOOK](#) (page 4-17)

## (5) [Direct TX] key

Touch this key to send a fax by direct transmission. When the [Direct TX] key is not highlighted, normal transmission (memory TX mode) is selected.

[To fax a large number of sheet originals, use the automatic document feeder.](#) (page 4-25)

[If you wish to send a fax ahead of other previously reserved fax transmissions, use direct transmission mode.](#) (page 4-27)

## (6) [Sub Address] key

Touch this key to enter a sub-address and passcode for F-code transmission.

[F-CODE DIALING](#) (page 4-102)

## (7) Customized keys

The keys that appear here can be changed to show settings or functions that you prefer.

[Customizing displayed keys](#) (page 4-9)

## (8) [Preview] key\*1

Touch to check the image that will be sent in the touch panel before transmission.

[CHECKING THE IMAGE TO BE TRANSMITTED \(Preview\)](#) (page 4-58)

## (9) key

Touch this key to dial a fax destination using a search number.

[USING A SEARCH NUMBER TO RETRIEVE A DESTINATION](#) (page 4-20)

## (10) [Speaker] key / [Pause] key / [Space] key

Touch this key to dial using the speaker.

When entering a fax number to be dialed, the key changes to the [Pause] key. When entering a sub-address, the key changes to the [Space] key.

[TRANSMISSION USING THE SPEAKER](#) (page 4-38)

## (11) [Resend] key / [Next Address] key

Touch this key to redial a fax number. When entering a fax number to be dialed, this key changes to the [Next Address] key.

[USING THE RESEND FUNCTION](#) (page 4-23)

## (12) Image settings

Touch this key to select the image settings (original size, exposure, resolution).

[IMAGE SETTINGS](#) (page 4-45)

## (13) key

This key appears when a special mode or 2-sided scanning is selected. Touch the key to display the selected special modes.



[Checking what special modes are selected](#) (page 4-9)

**(14) [Special Modes] key**

Touch this key to use a special mode.  
 ⓘ [SPECIAL MODES](#) (page 4-71)

**(15) [Print] / [Image] / [Fax] key**

When "Hold Setting for Received Data Print" or "Received Data Image Check Setting" is enabled in the system settings (administrator), this will appear when a fax is received.

-  : Only "Hold Setting for Received Data Print" is enabled
-  : Only "Received Data Image Check Setting" is enabled
-  : Both settings are enabled

ⓘ [PRINTING A PASSWORD-PROTECTED FAX \(Hold Setting For Received Data Print\)](#) (page 4-63)

ⓘ [CHECKING THE IMAGE BEFORE PRINTING](#) (page 4-64)

**(16) This shows the currently selected fax reception mode and the amount of free memory remaining.**

If the remaining amount of fax memory becomes low, faxes can no longer be received. Print or delete received data in memory to increase the remaining amount of memory.

ⓘ [RECEIVING FAXES](#) (page 4-60)

\*1 MX-B402SC Only

## Customizing displayed keys

Special mode keys and other keys can be displayed in the base screen. You can assign frequently used functions to these keys to access the functions with a single touch. To change the function that is assigned to a key, use "Customize Key Setting" in the Web pages. The following keys appear by factory default:

- **[Address Review] key**

Touch this to view a list of the destinations that have been selected in the address book and the numbers that have been directly entered with the numeric keys. This is the same key as the [Address Review] key in the address book screen.

- **[File] key, [Quick File] key**

Touch either key to use Quick File or File in document filing mode.

**Example: When "Erase", "Job Build", and "Slow Scan Mode" are assigned to the customized keys.**

These 3 keys can be changed as desired.

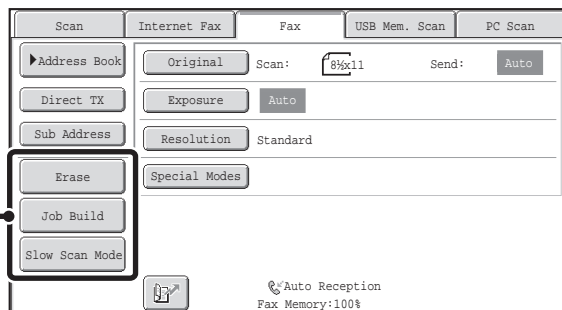

 Displaying a program key in the base screen will enable you to call up the program by simply touching the key.  
 ⓘ [STORING FAX OPERATIONS \(Program\)](#) (page 4-73)

---

 **System Settings (Administrator): Customize Key Setting**  
 Registration is performed in [System Settings] - [Operation Settings] - "Customize Key Setting" in the Web page menu.

## Checking what special modes are selected

The  key appears in the base screen when a special mode or 2-sided scanning is selected.

The  key can be touched to display the selected special modes. To close the screen, touch the [OK] key.

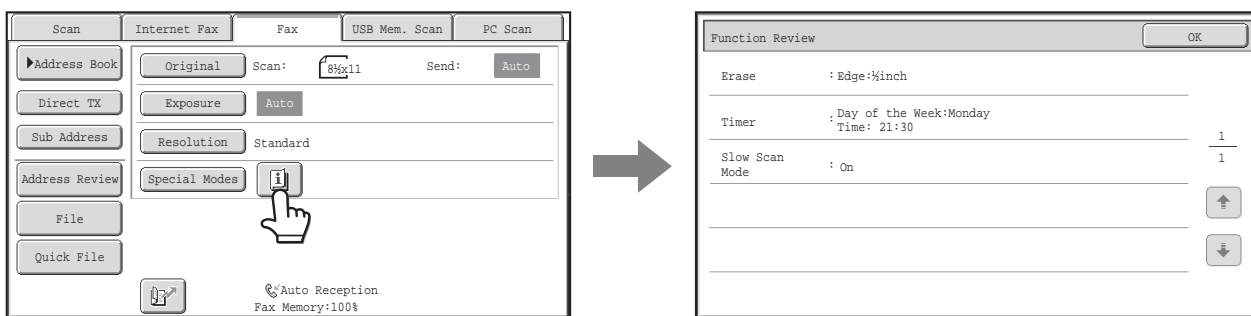

 The special mode settings cannot be changed from the function review screen. To change a setting, touch the [OK] key to close the function review screen and then touch the [Special Modes] key and select the setting that you wish to change.

# ADDRESS BOOK SCREEN

This screen is used to select a destination from the list of stored destinations.

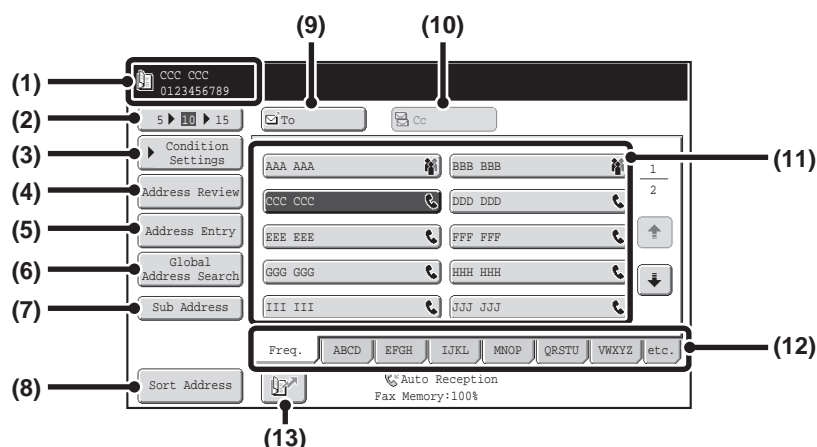

(1) This shows the destination that has been selected.

(2) **Number of displayed items selector key**

Touch to change the number of destinations (one-touch keys) displayed in the address book screen. Select 5, 10, or 15 destinations.

(3) **[Condition Settings] key**

Touch this key to select transmission settings and operations. When the key is touched, the base screen appears.

➤ [BASE SCREEN OF FAX MODE](#) (page 4-8)

(4) **[Address Review] key**

Touch this key to view a list of the selected destinations. The selected destinations can be changed.

➤ [CHECKING AND DELETING ENTERED DESTINATIONS](#) (page 4-19)

(5) **[Address Entry] key**

Not used in fax mode.

(6) **[Global Address Search] key**

When the use of a LDAP server has been enabled in the machine's Web page, a fax number can be obtained from a global address book.

➤ [RETRIEVING A DESTINATION FROM A GLOBAL ADDRESS BOOK](#) (page 4-21)

(7) **[Sub Address] key**

Touch this key to enter a sub-address and passcode for F-code transmission.

➤ [F-CODE DIALING](#) (page 4-102)

(8) **[Sort Address] key**

Touch this key to change the index tabs to custom indexes or to display one-touch keys by send mode.

➤ [CHANGING THE DISPLAY OF ONE-TOUCH KEYS IN THE ADDRESS BOOK SCREEN](#) (page 4-12)

(9) **[To] key**

Touch this key to enter a selected destination (one-touch key).

➤ [RETRIEVING A STORED DESTINATION](#) (page 4-18)

(10) **[Cc] key**

Not used in fax mode.

(11) **One-touch key display**

This shows the one-touch keys of the destinations that have been stored in the address book. This chapter refers to keys in which single destinations and groups are stored as one touch keys. Keys that have fax numbers stored are indicated by .

➤ [RETRIEVING A STORED DESTINATION](#) (page 4-18)

(12) **Index tabs**

Touch this to change indexes.

➤ [RETRIEVING A STORED DESTINATION](#) (page 4-18)

(13) ** key**

Touch this key to retrieve a destination using a search number.

➤ [USING A SEARCH NUMBER TO RETRIEVE A DESTINATION](#) (page 4-20)

 When using the network scanner function or the Internet fax function, a different icon will appear in the one-touch key display if a non-fax destination (address) is stored.

 [RETRIEVING A FAX NUMBER FROM THE ADDRESS BOOK](#) (page 4-17)



• **System Settings: Address Book** (page 7-17)

This is used to store fax numbers in one-touch keys.

• **System Settings (Administrator): The Number of Direct Address Keys Displayed Setting**

This is used to change the default setting for the number of one-touch keys displayed in the address book screen.

• **System Settings (Administrator): Default Display Settings**

One of the following screens can be selected for the initial screen that appears when the [IMAGE SEND] key is touched.

- Base screen of each mode (scan, Internet fax, fax, or data entry mode)
- Address book screen

• **System Settings (Administrator): Address Book Default Selection**

The following settings are available for the method of sorting the addresses that appear in the address book.

- Index type (alphabetical, custom)
- Address type (all, group, E-mail, FTP/Desktop, Network Folder, Internet fax, fax)

## CHANGING THE DISPLAY OF ONE-TOUCH KEYS IN THE ADDRESS BOOK SCREEN

You can show only destinations of a specific transmission mode in the address book screen, or change the displayed index tabs from the alphabetical tabs to the custom tabs. The procedure for selecting destinations does not change.

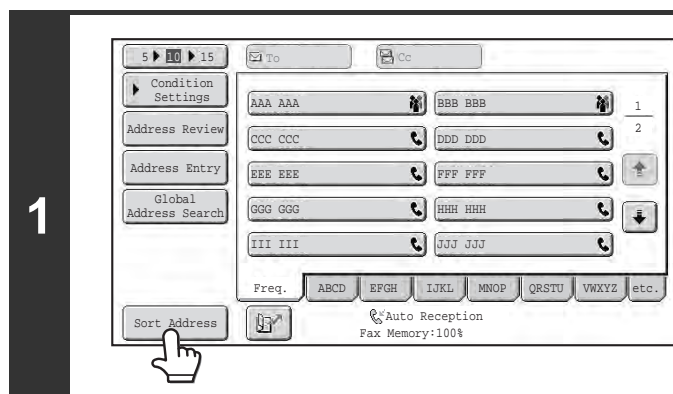

Touch the [Sort Address] key.

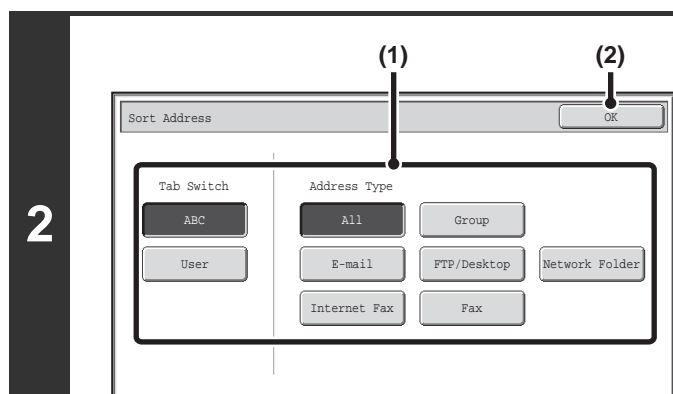

Change the display mode.

(1) Touch the key of the mode or tab that you wish to display.

- To show only the one-touch keys of a particular send mode, touch the desired mode key under "Address Type".
- To change the index tabs to the custom indexes, touch the [User] key under "Tab Switch".

(2) Touch the [OK] key.

## Index display

Indexes make it easy to search for a destination (one-touch key). The destinations are displayed separately using alphabetical search characters and index numbers. To display a stored destination, touch the appropriate index tab. It is convenient to store frequently used destinations in the [Freq.] index. Specify that a destination be displayed in the [Freq.] index when you store the destination.

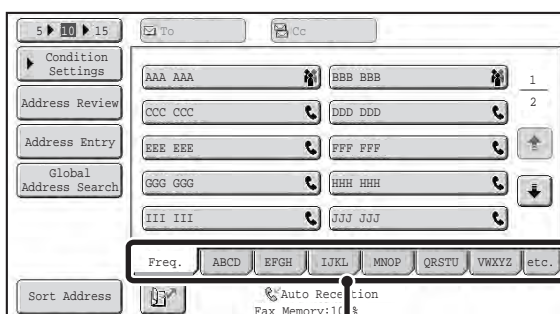

Index tabs

The destinations can be displayed in alphabetical order by their initials.

Each time the displayed index tab is touched, the display order changes in the following order: search numbers (page 4-20), ascending names, descending names, search numbers... When the display order is changed, the display order of the other index tabs also changes.

Ordered by search number (default)



Ascending names



Descending names



Index names can be changed using "Custom Index" in the system settings, allowing you to create groups of one-touch keys that can be easily recognized.



### System Settings: Custom Index (page 7-22)

This is used to store custom index names. The custom index where a one-touch key appears is specified when the transmission destination is stored in the key.

### Narrowing the search letter range

An alphabet tab on an index tab can be touched to display keys to further narrow the search range. For example, when the [ABCD] tab is touched, keys from "A" to "D" appear. If the [B] key is touched, only destinations starting with the letter "B" will appear. To cancel, touch the key again. Note that the search letter range cannot be narrowed on the [Freq.] tab, the [etc.] tab, or on a user index tab.

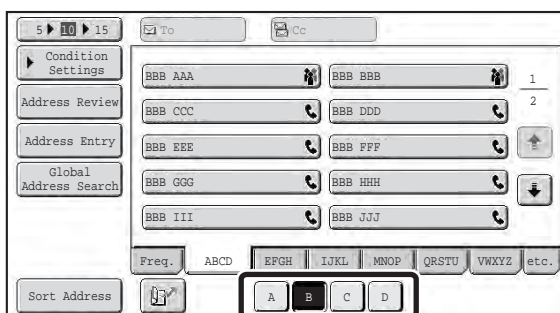



# FAX TRANSMISSION SEQUENCE

This section explains the basic procedure for sending a fax.

## Place the original

Place the original in the document feeder tray of the automatic document feeder, or on the document glass.

 [PLACING THE ORIGINAL](#) (page 1-37)





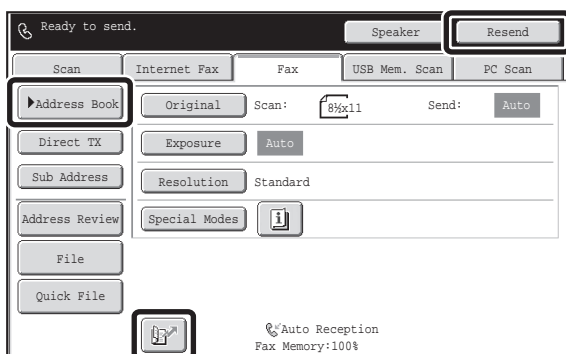

## Enter the destination fax number

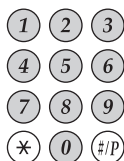

or





- [Address Book] key: Select a destination that is stored in the address book or look up a destination in a global address book.
  -  [RETRIEVING A FAX NUMBER FROM THE ADDRESS BOOK](#) (page 4-17)
-  key: Use a search number to specify a destination stored in the address book.
  -  [USING A SEARCH NUMBER TO RETRIEVE A DESTINATION](#) (page 4-20)
- [Resend] key: Select a fax number from the last eight destinations used for transmission.
  -  [USING THE RESEND FUNCTION](#) (page 4-23)
- Numeric keys: Enter a fax number.
  -  [ENTERING A FAX NUMBER WITH THE NUMERIC KEYS](#) (page 4-16)

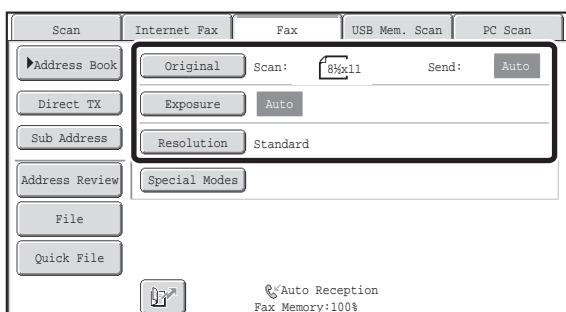

## Select image settings



Select settings for the original to be faxed.

- [Original] key: Use this key to select the original size, the original send size, and 2-sided original scanning.
  -  [SPECIFYING THE SCAN SIZE AND SEND SIZE](#) (page 4-47), [AUTOMATICALLY SCANNING BOTH SIDES OF AN ORIGINAL \(2-Sided Original\)](#) (page 4-46)
- [Exposure] key: Use this key to adjust the exposure of the image.
  -  [CHANGING THE EXPOSURE](#) (page 4-56)
- [Resolution] key: Use this key to adjust the resolution of the image.
  -  [CHANGING THE RESOLUTION](#) (page 4-57)



## Special mode settings

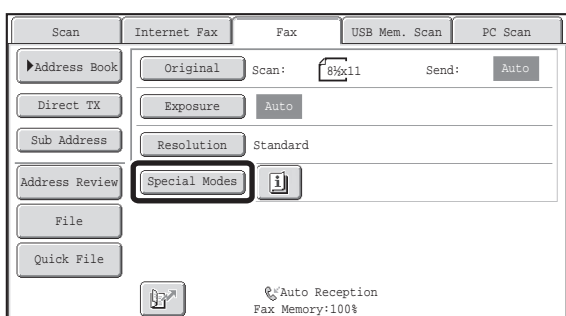

Touch the [Special Modes] key to select special modes such as timer transmission and the erase function.



## Begin transmission

Scan the original and send the fax.

If the original is placed on the document glass, follow these steps to start scanning and transmit:

### When sending a fax normally (memory transmission)

- (1) Press the [START] key.
- (2) When scanning is finished, replace the original with the next original.
- (3) Press the [START] key.
- (4) Repeat steps (2) and (3) until all originals have been scanned.
- (5) Touch the [Read-End] key.

### When sending a fax in direct transmission mode

Multiple originals cannot be scanned in direct transmission mode.  
Press the [START] key to start transmission.



When transmission ends, image settings and convenient special mode settings are cleared.



### To cancel scanning...

Press the [STOP] key (⏏).



### System Settings (Administrator): Default Display Settings

The settings can be kept in effect a fixed period of time after scanning is completed.

# ENTERING DESTINATIONS

This section explains how to enter destination fax numbers.

Destination fax numbers can be entered using the numeric keys, or by retrieving a previously stored fax number using the address book or a search number.

## ENTERING A FAX NUMBER WITH THE NUMERIC KEYS

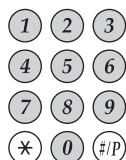

Enter the destination fax number with the numeric keys.



Take care to enter the correct number.



**If an incorrect number is entered...**

Press the [CLEAR] key (C) to clear the number and then enter the correct number.

## Entering a pause between digits of the number

Enter a pause after the number used to dial out from a PBX (for example, after "0"), or after the country code when dialing an international number.

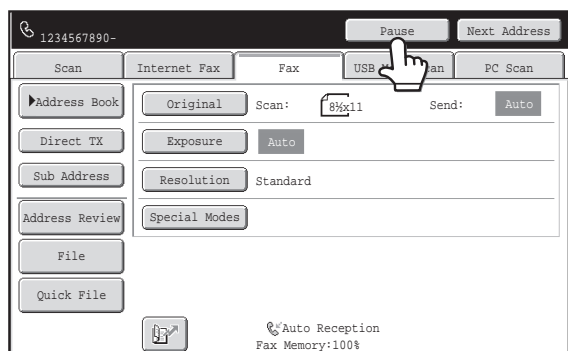

**Touch the [Pause] key.**

A hyphen "-" is entered when the [Pause] key is touched once.



**System Settings (Administrator): Pause Time Setting**

This is used to set the length of pauses. The default setting is 2 seconds.





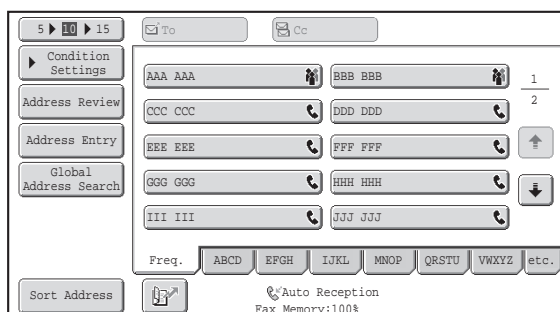

# RETRIEVING A FAX NUMBER FROM THE ADDRESS BOOK

The address book screen shows stored destinations as one-touch keys.

A destination fax number is retrieved by simply touching the one-touch key of that destination. This is called "one-touch dialing". It is also possible to store multiple fax numbers in a one-touch key, allowing you to retrieve all the numbers by simply touching the key. This is called "group dialing". This dialing method is convenient when you wish to send a fax to (or poll) multiple fax destinations.



When destinations of other scan modes are stored in addition to fax destinations, an icon indicating the mode appears together with the name of the destination in each one-touch key.

Icon	Mode
	Fax
	Scan to E-mail
	Internet fax (Direct SMTP)
	Scan to FTP
	Scan to Network Folder
	Scan to Desktop
	Group key with multiple destinations



## System Settings: [Address Book](#) (page 7-17)

This is used to store destinations (names and fax numbers) in the address book.

# RETRIEVING A STORED DESTINATION

A destination fax number is retrieved by simply touching the one-touch key of that destination.

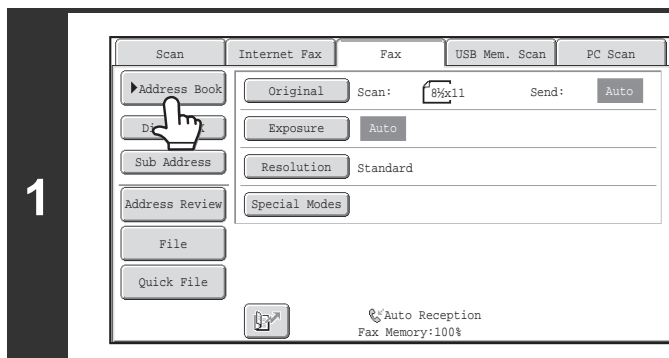

Touch the [Address Book] key.

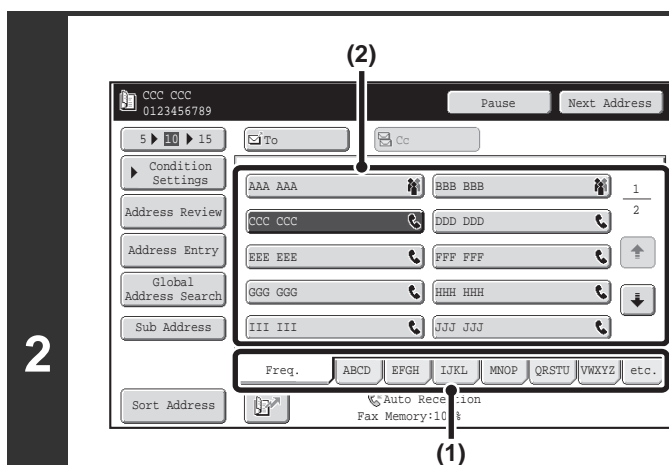

Select the destination.

- (1) Touch the index tab where the destination is stored.
- (2) Touch the one-touch key of the desired destination.

If you select an incorrect destination, touch the key again to cancel the selection.



- Frequently used destinations can be displayed in the [Freq.] index. Specify that a destination be displayed in the [Freq.] index when you store the destination.
- **To continue specifying other destinations...**  
Touch the [Next Address] key and repeat (1) and (2) of this step.



- **System Settings (Administrator): Must Input Next Address Key at Broadcast Setting**  
This setting determines whether or not the [Next Address] key can be omitted before specifying the next destination. Factory default setting: The [Next Address] key can be omitted.
- **System Settings (Administrator): Disable Switching of Display Order**  
This is used to disable switching of the order of display of the one-touch keys in the address book screen. The currently selected display order will be the order that is used after this setting is enabled.

# CHECKING AND DELETING ENTERED DESTINATIONS

When multiple destinations have been entered, you can display and check the destinations. You can also delete a destination (cancel selection of the destination).

1

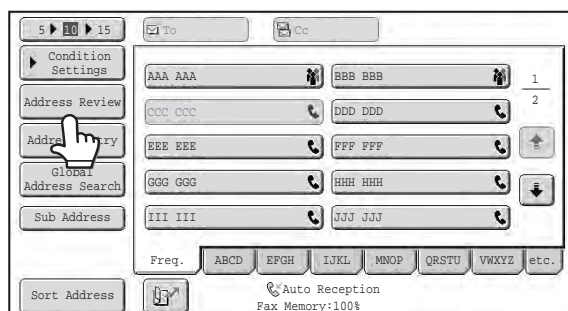

Touch the [Address Review] key.

2

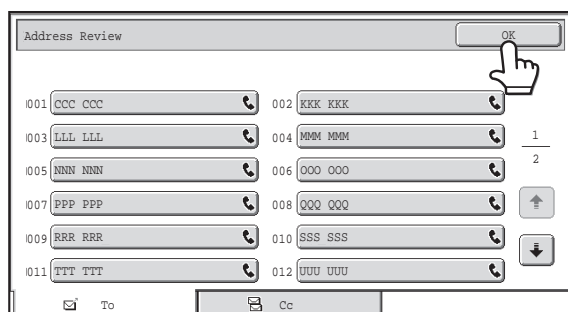

Check the destinations and then touch the [OK] key.



## To delete a destination...

Touch the one-touch key of the destination that you wish to delete. A message will appear to confirm the deletion. Touch the [Yes] key. Touch the [Detail] key to check the specified destination type and name.

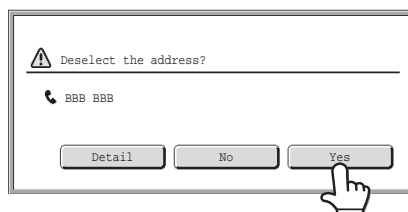



# USING A SEARCH NUMBER TO RETRIEVE A DESTINATION

A destination stored in the address book can be retrieved using the  key. This can be done in the base screen of any of the modes or in the address book screen.

1

Scan	Internet Fax	Fax	USB Mem. Scan	PC Scan
▶Address Book	Original	Scan: 8% x11	Send: Auto	
Direct TX	Exposure	Auto		
Sub Address	Resolution	Standard		
Address Review	Special Modes			
File				
Quick File				

 Auto Reception  
Fax Memory:100%

Touch the  key.

2

1	2	3
4	5	6
7	8	9
*	0	#/P

**Enter the 3-digit search number of the address with the numeric keys.**

When the 3-digit search number is entered, the stored address is retrieved and specified as a destination.

---

2



- The search number is programmed when the destination is stored in the address book.
- If you do not know the search number, print the one-touch address list using "Sending Address List" in the system settings.
- When entering search numbers such as "001" and "011", "0" can be omitted. For example, to enter "001", enter "1" and touch the  key or the [Next Address] key.

2



**If an incorrect search number is entered...**

Press the [CLEAR] key () to clear the number and enter the correct number.

# RETRIEVING A DESTINATION FROM A GLOBAL ADDRESS BOOK

If a LDAP server is stored in the Web pages, you can look up a destination fax number in a global address book.

1

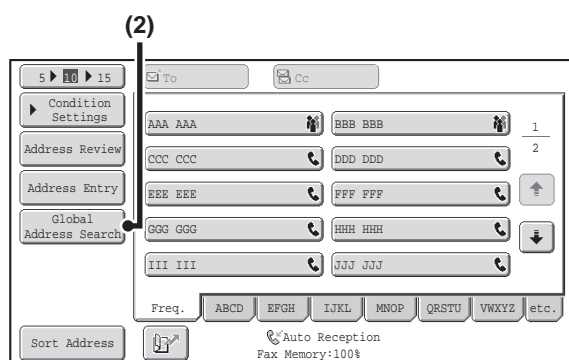

Open the global address search screen.

(1) Touch the [Address Book] key in the base screen.

For the [Address Book] key, see "BASE SCREEN OF FAX MODE" (page 4-8).

(2) Touch the [Global Address Search] key.

2

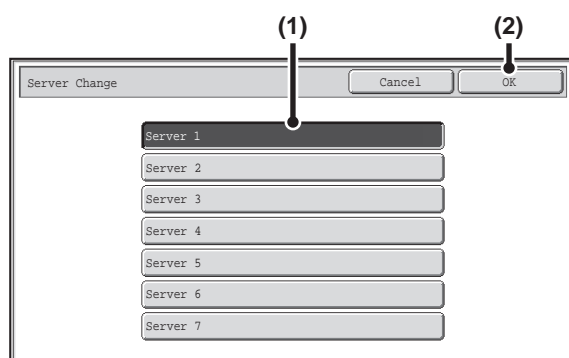

Search for the destination.

If only one LDAP server has been stored, (1) and (2) are not necessary. Go directly to (3). If an authentication screen for the LDAP server appears, enter your user name and password.

(1) Touch the key of the LDAP server that you wish to use.

If an authentication screen for the LDAP server appears, enter your user name and password.

(2) Touch the [OK] key.

(3) Search for the destination in the search screen.

Enter search characters for the destination and touch the [Search] key. The search results will appear after a brief interval.

For the procedure for entering text, see "ENTERING TEXT" (page 1-76) in "1. BEFORE USING THE MACHINE".



## How to search

Enter a maximum of 64 characters for the search characters. The system will look for names starting with the entered letters.

An asterisk \* can be used as follows:

XXX\*: Names beginning with "XXX".

\*XXX: Names that end with "XXX".

\*XXX\*: Names that include "XXX".

AA\*XX: Names that start with "AA" and end with "XX".



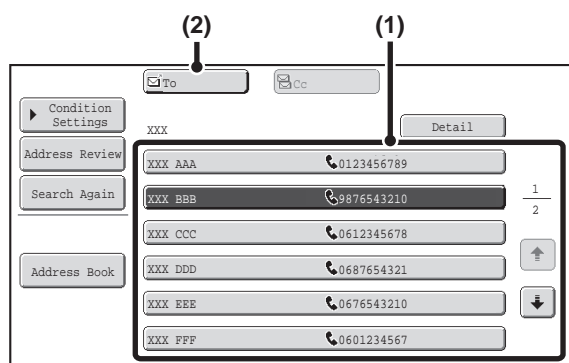

## Select the destination.

### (1) Touch the key of the desired destination.

If no names are found that match the search letters, a message will appear. Touch the [OK] key to close the message and touch the [Search Again] key to search again.

### (2) Touch the [To] key.

This enters the selected destination.

If you wish to select another destination, repeat steps (1) and (2) above.



- If 30 or more matches are found, a message will appear in the screen. Touch the [OK] key to close the message. A maximum of 300 search results are displayed. If the desired destination was not found, touch the [Search Again] key to add more search letters.
- **To check the information stored in a destination...**  
Touch the key of the destination and then touch the [Detail] key. The information stored for the selected destination will appear. Check the information and then touch the [OK] key to return to the search results screen.
- **If a screen for selecting the item to be used appears...**  
If the selected destination includes an E-mail address or other address in addition to the fax number or telephone number, you will need to select which item you wish to use. Touch the [Fax] key to retrieve the fax number.

## Storing a destination from a global address book in the machine's address book

A destination from a global address book can be stored in the machine's address book as a one-touch key. Touch the [Detail] key in the search results screen of the global address book (the screen of step 3 above) to display information on the selected destination. Touch the [Register] key in the detailed information screen and then touch the item to be used (the [Fax] key in this case). The following screen will appear.

The information stored in the global address book is automatically entered. (The settings can be changed if needed. For detailed information on each item, see "Address Control" (page 7-17) in "7. SYSTEM SETTINGS".) However, configure the items below manually. To complete the storing procedure, touch the [Exit] key.

- [Initial] key: Touch this key to enter the initials that determine where the destination will appear in the alphabetical index and the order of one-touch key display. Enter up to 10 characters for the initials.
- [Index] key: Touch this key to select the custom index in which the address will appear. You can also select whether or not the destination will be included on the [Freq.] tab of the address book.
- [Mode] key: Touch this key to configure the "Transmission Speed" and "International Correspondence Mode" settings. These settings have already been configured, however, if the destination is an international destination, or if you find that communication errors frequently occur when communicating with that destination, you can try changing the settings.

# USING THE RESEND FUNCTION

The destinations of the most recent 8 transmissions by fax, Scan to E-mail, and/or Internet fax are stored. One of these can be selected to resend to that destination.

1

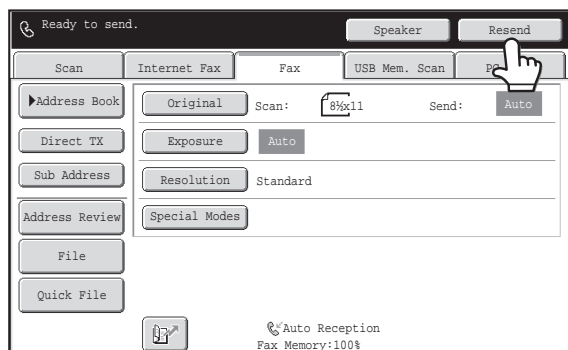

Touch the [Resend] key.

2

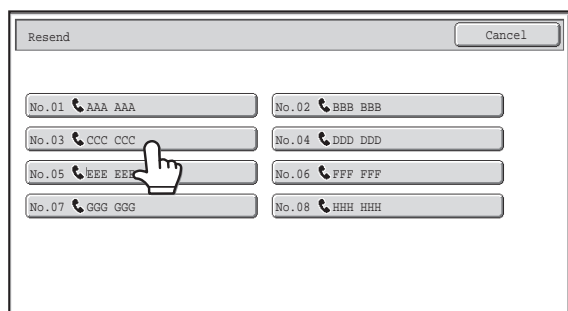

Touch the key of the fax destination that you wish to redial.

The last 8 transmission destinations appear.



- If numeric keys were pressed during the previous transmission, the [Resend] key may not dial the correct number.
- The fax addresses below are not stored as addresses for which resend is possible.
  - A one-touch key in which multiple destinations are stored (group key)
  - Broadcast destinations
  - Destinations transmitted to using a program



#### System Settings (Administrator): Disable [Resend] on Fax/Image Send Mode

This prohibits use of the resend function. When this setting is enabled, the [Resend] key cannot be used in the base screen of image send mode.

# CHAIN DIALING

Number sequences entered with the numeric keys and/or one-touch keys can be linked together with pauses and dialed as a single number.

Use chain dialing to dial a long number (such as an international number) when the country code and/or area code are stored separately in one-touch keys.

## Example: Using chain dialing to dial an international number

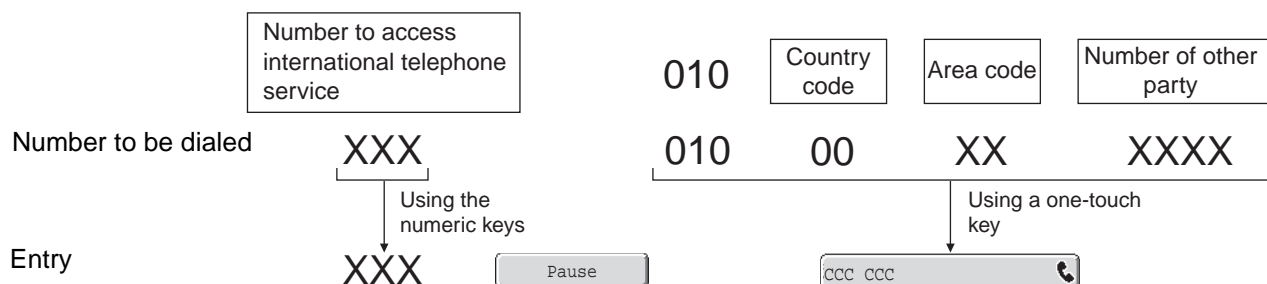

### System Settings (Administrator): Pause Time Setting

This is used to set the length of pauses. The default setting is 2 seconds.

# BASIC TRANSMISSION METHODS

This section explains the basic procedures for sending a fax.

---

---

## TRANSMISSION METHODS

The methods that can be used to send a fax from the machine are explained below. Select the method that best suits your needs.

### To fax a large number of sheet originals, use the automatic document feeder.

The originals will be scanned into memory and then transmitted (memory transmission).

When memory transmission is selected and multiple originals are placed in the automatic document feeder (and the line is free), transmission will begin as soon as the first page is scanned and will take place while the remaining pages are being scanned (Quick Online transmission).

If transmission cannot begin immediately because the line is in use, all pages will be scanned into memory and the transmission will be reserved.

☞ [USING THE AUTOMATIC DOCUMENT FEEDER FOR TRANSMISSION](#) (page 4-30)

When a fax transmission or reception is already in progress, the following procedure can be performed to reserve a transmission job. To check reserved transmission jobs, display the job status screen.

☞ [CHECKING THE STATUS OF FAX JOBS](#) (page 4-119)

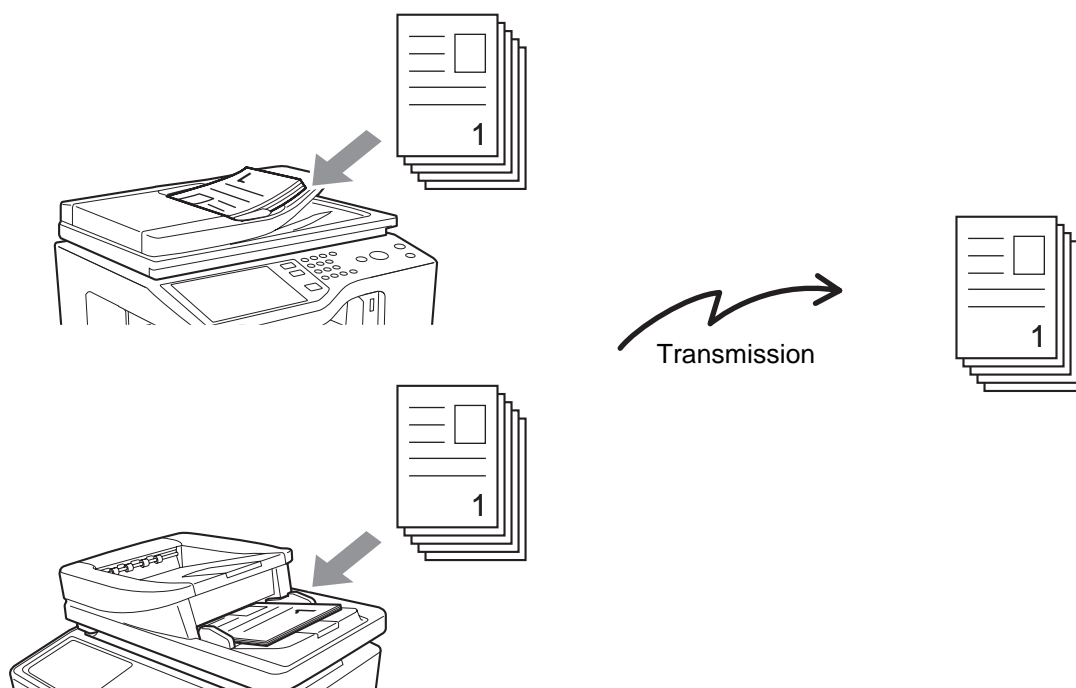

- If memory becomes full while the first original page is being scanned, transmission will stop.
- In the following situations, the transmission will be automatically reserved (memory transmission)
  - When the line is busy or a communication error occurs and automatic resending is enabled.
    - ☞ [WHEN THE LINE IS BUSY](#) (page 4-28), [WHEN A COMMUNICATION ERROR OCCURS](#) (page 4-28)
  - The machine is already using the line to send or receive a fax.
  - Another fax transmission was reserved ahead of your fax.
  - One of the following functions is being used for transmission:
    - Broadcast transmission, F-code transmission, timer transmission, Card Shot, Job Build, Business Card Scan
  - The document glass is being used (except when the speaker is being used to dial).
- Up to 94 transmission jobs can be reserved.
- When the transmission is finished, the scanned original pages are cleared from memory. However, when the document filing function is used, the transmitted fax is stored.

 **System Settings (Administrator): Quick On Line Sending**  
 This is used to disable Quick Online transmission. In this case, fax transmissions will be sent by memory transmission (reserved and then transmitted).

## To fax thick originals or pages of a book, use the document glass.

☞ [USING THE DOCUMENT GLASS FOR TRANSMISSION](#) (page 4-34)

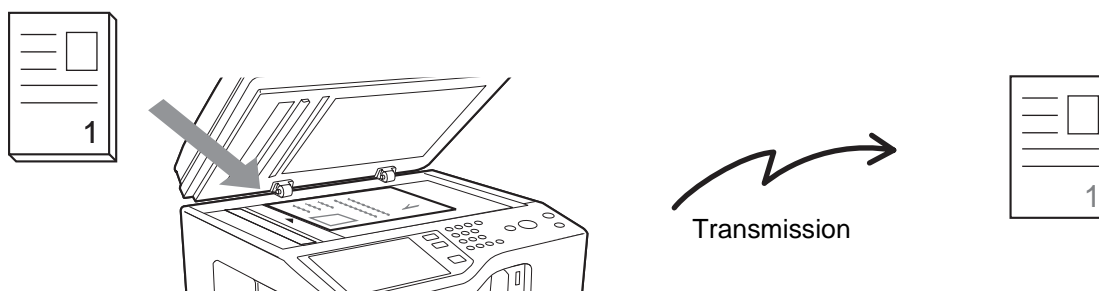

 When the document glass is being used for a transmission, Quick Online transmission will not operate.

## If you wish to send a fax ahead of other previously reserved fax transmissions, use direct transmission mode.

The original is transmitted directly to the receiving fax machine without being scanned into memory.

When direct transmission mode is used, transmission will begin as soon as the transmission in progress is completed (ahead of any previously reserved transmissions).

To send a fax by direct transmission, touch the [Direct TX] key in the base screen.

 [USING THE AUTOMATIC DOCUMENT FEEDER TO SEND A FAX IN DIRECT TRANSMISSION MODE](#) (page 4-32)

 [USING THE DOCUMENT GLASS TO SEND A FAX IN DIRECT TRANSMISSION MODE](#) (page 4-36)

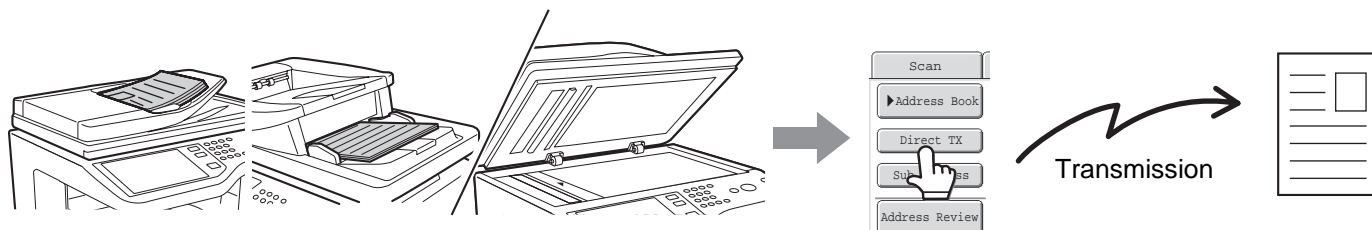

- When transmission in direct transmission mode ends, the mode automatically changes back to memory transmission mode.
- When the document glass is used, multiple original pages cannot be scanned.

## PLACEMENT ORIENTATION OF THE ORIGINAL

A 5-1/2" x 8-1/2"(A5) or B5 size original in landscape orientation will be rotated 90 degrees and transmitted as a 5-1/2" x 8-1/2"(A5) or B5 image in portrait orientation.

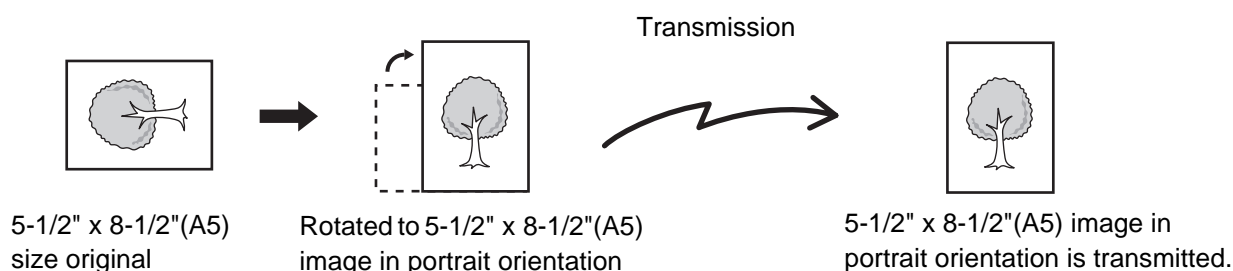

### System Settings (Administrator): Rotation Sending Setting

The factory default setting is rotate before transmission. If this setting is disabled, the original will be transmitted in the orientation in which it is placed.

## WHEN THE LINE IS BUSY

If the line is busy when you send a fax, transmission will be re-attempted automatically after a preset interval. This function only operates in memory transmission mode. In direct transmission mode or manual transmission mode, the transmission will be canceled. Wait briefly and then try sending the fax again.



### To cancel transmission...

Cancel the transmission from the job status screen.

[CANCELING A FAX IN PROGRESS OR A RESERVED FAX](#) (page 4-126)



### System Settings (Administrator): Recall in Case of Line Busy

This is used to set the number of recall attempts and the interval between attempts when the connection cannot be established because the line is busy. The factory default setting is 2 attempts at an interval of 3 minutes.

## WHEN A COMMUNICATION ERROR OCCURS

If a communication error occurs or the other fax machine does not answer the call within a preset period of time, transmission will be re-attempted automatically after a preset interval. This function only operates in memory transmission mode.



### To cancel transmission...

Cancel the transmission from the job status screen.

[CANCELING A FAX IN PROGRESS OR A RESERVED FAX](#) (page 4-126)



### System Settings (Administrator): Recall in Case of Communication Error

This is used to set the number of recall attempts and the interval between attempts when a transmission fails due to an error. The factory default setting is attempt at an interval of 3 minutes.

## FAX DESTINATION CONFIRMATION MODE

The fax destination confirmation mode displays a destination confirmation message when a fax transmission is performed to prevent accidental transmission to the wrong destination. This function is enabled in the system settings (administrator). When the function is enabled, a message will appear to confirm the destination when the [START] key is pressed to begin fax transmission.

The message that appears will vary depending on the method used to specify the destination.

### Destination specified by one-touch key/search number

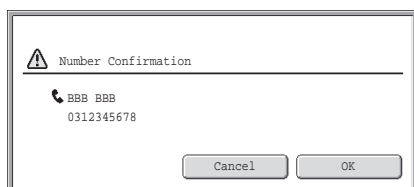

Make sure that the destination indicated in the message is correct and touch the [OK] key. Scanning will begin. If the destination is not correct, touch the [Cancel] key and select the destination again.

### Destination specified by the numeric keys, [Resend] key, or [Global Address Search] key

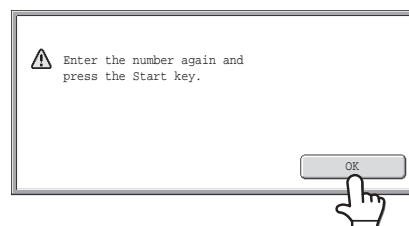

Touch the [OK] key, re-enter the destination with the numeric keys, and press the [START] key.

If the re-entered destination is correct, scanning will begin.

If the re-entered destination is not correct, a message will appear. Touch the [OK] key and re-enter the destination. If an incorrect number is entered for confirmation 3 times in a row, the screen will revert to the base screen.

- Even if a one-touch key or search number was used to specify the destination, if the [Sub Address] key is used to enter a sub-address and passcode, the fax number must be re-entered during confirmation. After re-entering the fax number, touch the [Sub Address] key and enter the sub-address and passcode.
- If chain dialing was used, touch the [Pause] key to enter "-" during confirmation.

## Functions that cannot be used

When the fax destination confirmation function is enabled, only one destination is allowed, and thus the following functions cannot be used.

### • Broadcast transmission to multiple destinations including fax destinations

Group keys and program keys that contain multiple fax destinations cannot be used. After one destination is specified, specification of a destination by search number is no longer possible, and keys such as another one-touch key, the [Next Address] key, the [Address Entry] key, and the [Global Address Search] key cannot be selected.

### • Transmission using the speaker key

A destination cannot be specified after the [Speaker] key is pressed.



### System Settings (Administrator): Fax Dest. Confirmation Mode

This setting is used to have a destination confirmation message appear when a fax is sent.



# USING THE AUTOMATIC DOCUMENT FEEDER FOR TRANSMISSION

This section explains how to use the automatic document feeder to send a fax.

## MX-B402:

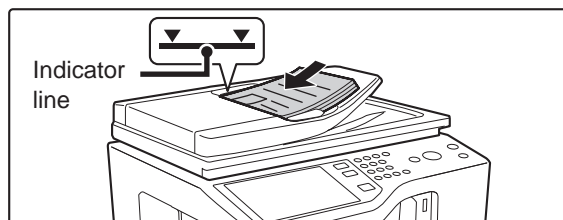

**Place the originals face up in the document feeder tray with the edges aligned evenly.**

Insert the originals all the way into the document feeder tray. Multiple originals can be placed in the document feeder tray. The stack of originals must not be higher than the indicator line on the tray. When the original is a different size than the size setting, set the original size.

➤ [SPECIFYING THE SCAN SIZE AND SEND SIZE](#) (page 4-47)

## MX-B402SC:

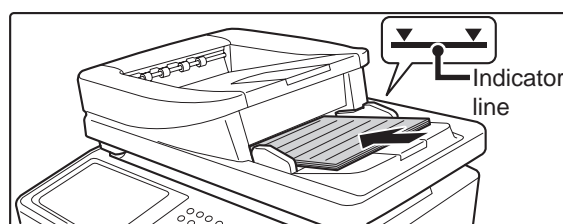

1

When sending a multi-page fax, the automatic document feeder and the document glass cannot both be used to scan the original pages.

**Enter the destination fax number.**

**(1) Touch the [Address Book] key in the base screen.**

For the [Address Book] key, see "[BASE SCREEN OF FAX MODE](#)" (page 4-8).

**(2) Touch the one-touch key of the desired destination.**

2

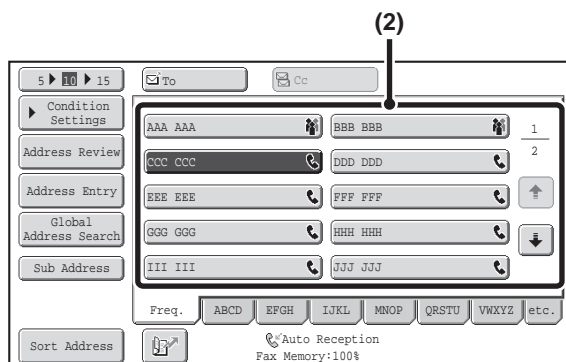

In addition to specification by one-touch key, a destination can also be specified using a search number. You can also directly enter a fax number with the numeric keys or look up a destination in a global address book. For more information, see "[ENTERING DESTINATIONS](#)" (page 4-16).

**Press the [START] key.**

Scanning begins.

When scanning is completed, the machine sounds a beep.

3

When scanning is completed, "Job stored." will be displayed together with a job control number. This number can be used to locate the job in the Transaction Report or in the Image Sending Activity Report.



- If a fax is being received when the transmission operation is performed, the transmission will be reserved and transmitted after fax reception is completed.
- If the memory becomes full while the originals are being scanned, a message will appear and scanning will stop. If Quick Online transmission is taking place, the originals that were scanned will be transmitted. If Quick Online is not enabled, the transmission will be canceled.

**System Settings (Administrator): Scan Complete Sound Setting**

The scan complete sound can be selected.

**To cancel scanning...**

Press the [STOP] key (⏹) to cancel the operation.

# USING THE AUTOMATIC DOCUMENT FEEDER TO SEND A FAX IN DIRECT TRANSMISSION MODE

MX-B402:

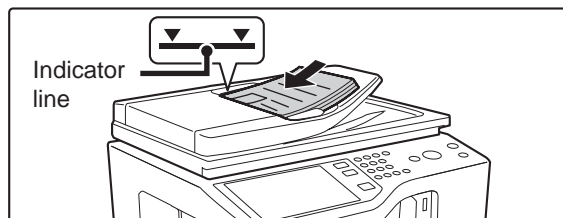

MX-B402SC:

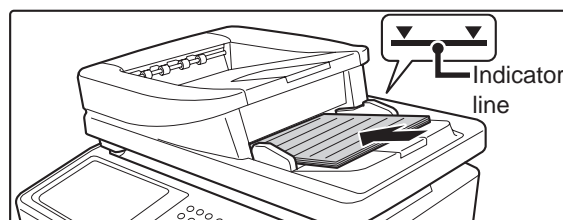

Place the originals face up in the document feeder tray with the edges aligned evenly.

Insert the originals all the way into the document feeder tray. Multiple originals can be placed in the document feeder tray. The stack of originals must not be higher than the indicator line on the tray.

When the original is a different size than the size setting, set the original size.

☞ [SPECIFYING THE SCAN SIZE AND SEND SIZE](#) (page 4-47)

1

Enter the destination fax number.

(1) Touch the [Address Book] key in the base screen.

For the [Address Book] key, see "[BASE SCREEN OF FAX MODE](#)" (page 4-8).

(2) Touch the one-touch key of the desired destination.

(3) Touch the [Condition Settings] key.

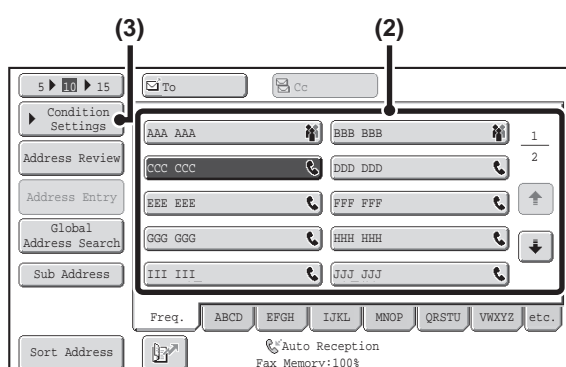

2



- Only one destination can be entered. A one-touch key in which multiple destinations are stored (group key) cannot be used.
- In addition to specification by one-touch key, a destination can also be specified using a search number. You can also directly enter a fax number with the numeric keys or look up a destination in a global address book. For more information, see "[ENTERING DESTINATIONS](#)" (page 4-16).

3

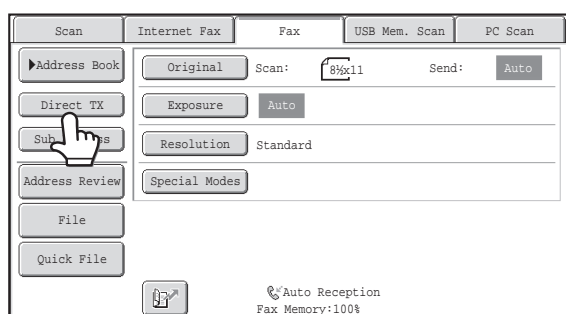

Touch the [Direct TX] key.

## 4

**Press the [START] key.**

Transmission begins.

**To cancel transmission...**

While "Dialing. Press [▽] to cancel." appears or while the fax is being transmitted, press the [STOP] key (Ⓢ).



- The following functions cannot be used with direct transmission:  
Program, Timer Transmission, Card Shot, Job Build, Polling Memory, File, Quick File, Memory Box, 2-Sided Original Scanning, Global Address Search
- Resending will not take place when a direct transmission is not successful due to a communication error or other reason.
- If a fax transmission is already in progress when the direct transmission operation is performed, the direct transmission will wait until the previous transmission is finished. When the previous transmission is completed, the direct transmission will begin. While the direct transmission is waiting, the [JOB STATUS] key can be pressed to display the job status screen. No other operations are possible.  
 [CHECKING THE STATUS OF FAX JOBS](#) (page 4-119)

# USING THE DOCUMENT GLASS FOR TRANSMISSION

To fax a thick original or other original that cannot be fed through the automatic document feeder, open the automatic document feeder and place the original on the document glass.

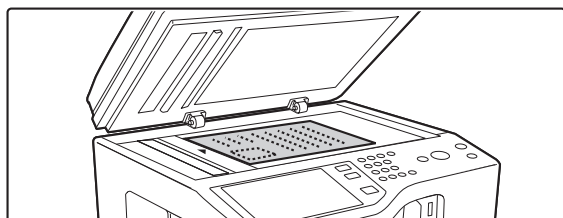

Open the automatic document feeder, place the original face down on the document glass, and then gently close the automatic document feeder.

Document glass scale

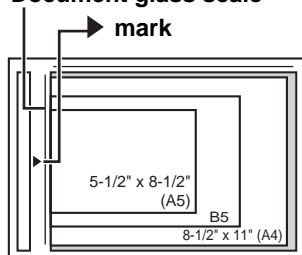

- Align the middle of the original with the tip of the ► mark at the middle of the scale on the left side of the document glass.
- Place the original in the appropriate position for its size as shown above.
- When the original is a different size than the size setting, set the original size.
  - ▶ [SPECIFYING THE SCAN SIZE AND SEND SIZE](#) (page 4-47)

1



- When faxing a multi-page original, scan each page in order starting from the first page.
- When sending a multi-page fax, the automatic document feeder and the document glass cannot both be used to scan the original pages.

2

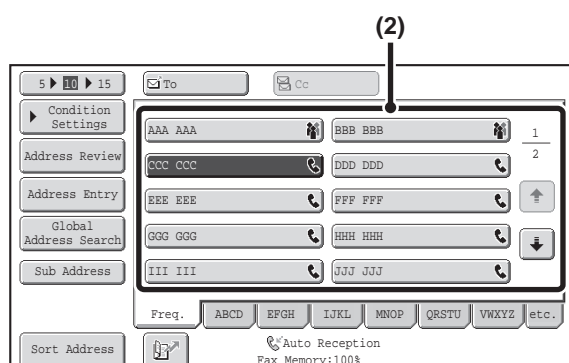

Enter the destination fax number.

- (1) Touch the [Address Book] key in the base screen.  
For the [Address Book] key, see "[BASE SCREEN OF FAX MODE](#)" (page 4-8).
- (2) Touch the one-touch key of the desired destination.



In addition to specification by one-touch key, a destination can also be specified using a search number. You can also directly enter a fax number with the numeric keys or look up a destination in a global address book. For more information, see "[ENTERING DESTINATIONS](#)" (page 4-16).

**3 Press the [START] key.**

Scanning begins.

**4 If you have another page to scan, change pages and then press the [START] key.**

Repeat until all originals have been scanned.

-  If no action is taken for one minute, scanning automatically ends and the transmission is reserved.

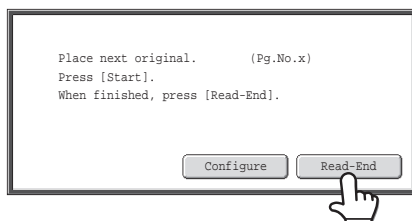
**Touch the [Read-End] key.**

A beep sounds.

Open the automatic document feeder and remove the original.

**5**  • When scanning is completed, "Job stored." will be displayed together with a job control number.

This number can be used to locate the job in the Transaction Report or in the Image Sending Activity Report.

- If no action is taken for one minute after the confirmation screen appears, scanning automatically ends and the transmission is reserved.
- The [Configure] key can be touched to change the exposure, resolution, scan size, and send size for each original page scanned. However, when "Card Shot" is selected in the special modes, only the exposure can be changed, and this can only be done when scanning each even page number of the original pages.

 **To cancel transmission...**Press the [STOP] key () before the [Read-End] key is touched.

-  • If a fax is being received when the transmission operation is performed, the transmission will be reserved and transmission will take place after fax reception is completed.
- If the memory becomes full while the originals are being scanned, a message will appear and transmission will be canceled.

# USING THE DOCUMENT GLASS TO SEND A FAX IN DIRECT TRANSMISSION MODE

When sending a fax from the document glass in direct transmission mode, only one page can be transmitted.

1

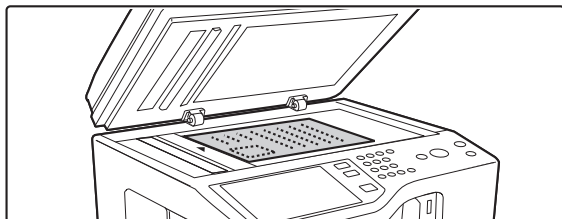

Open the automatic document feeder, place the original face down on the document glass, and then gently close the automatic document feeder.

Document glass scale

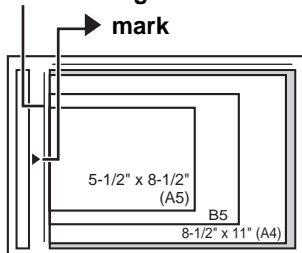

- Align the middle of the original with the tip of the ► mark at the middle of the scale on the left side of the document glass.
- Place the original in the appropriate position for its size as shown above.
- When the original is a different size than the size setting, set the original size.  
 ⓘ [SPECIFYING THE SCAN SIZE AND SEND SIZE](#) (page 4-47)



Do not place any objects under the original size detector. Closing the automatic document feeder with an object underneath may damage the original size detector plate and prevent correct detection of the document size.

2

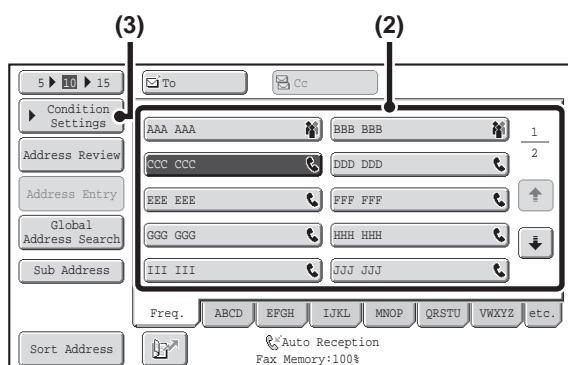

Enter the destination fax number.

- (1) Touch the [Address Book] key in the base screen.

For the [Address Book] key, see "[BASE SCREEN OF FAX MODE](#)" (page 4-8).

- (2) Touch the one-touch key of the desired destination.

- (3) Touch the [Condition Settings] key.



- Only one destination can be entered. A one-touch key in which multiple destinations are stored (group key) cannot be used.
- In addition to specification by one-touch key, a destination can also be specified using a search number. You can also directly enter a fax number with the numeric keys or look up a destination in a global address book. For more information, see "[ENTERING DESTINATIONS](#)" (page 4-16).

3

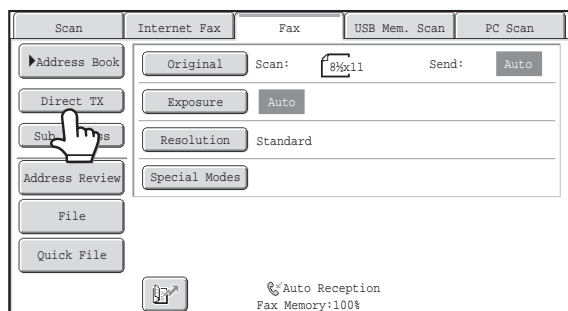

Touch the [Direct TX] key.

4

### Press the [START] key.

Transmission begins.



#### To cancel transmission...

While "Dialing. Press [STOP] to cancel" appears in the display, press the [STOP] key (⏏).



- The following functions cannot be used with direct transmission:  
Program, Timer Transmission, Card Shot, Job Build, Polling Memory, File, Quick File, Memory Box, 2-Sided Original Scanning, Global Address Search
- Resending will not take place when a direct transmission is not successful due to a communication error or other reason.
- If a fax transmission is already in progress when the direct transmission operation is performed, the direct transmission will wait until the previous transmission is finished. When the previous transmission is completed, the direct transmission will begin. While the direct transmission is waiting, the [JOB STATUS] key can be pressed to display the job status screen. No other operations are possible.  
 ⓘ [CHECKING THE STATUS OF FAX JOBS](#) (page 4-119)



# TRANSMISSION USING THE SPEAKER

When the speaker is used to dial, the fax is sent after the number is dialed and the connection is established. If a person answers, you will be able to hear his or her voice, but you will not be able to speak.

## 1 Place the original.

Place the original face up in the document feeder tray, or face down on the document glass.

☞ [PLACING THE ORIGINAL](#) (page 1-37)

When the document glass is used, only one page can be transmitted.

When the original is a different size than the size setting, set the original size.

☞ [SPECIFYING THE SCAN SIZE AND SEND SIZE](#) (page 4-47)

## 2 Enter the destination fax number.

### (1) Touch the [Speaker] key.

You will hear the dial tone through the machine's speaker.

### (2) Touch the [Address Book] key in the base screen.

For the [Address Book] key, see "[BASE SCREEN OF FAX MODE](#)" (page 4-8).

### (3) Touch the one-touch key of the desired destination.

A group key cannot be used.

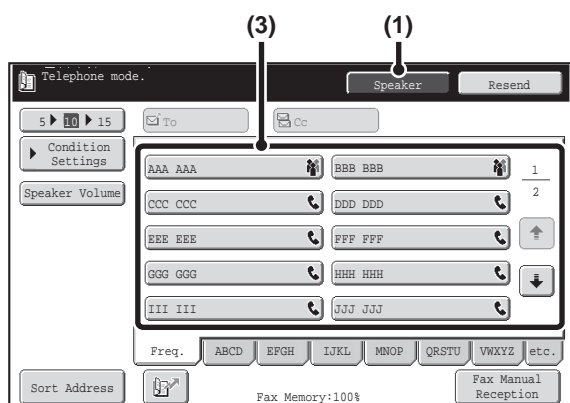

- In addition to specification by one-touch key, a destination can also be specified using a search number. You can also directly enter a fax number with the numeric keys or look up a destination in a global address book. For more information, see "[ENTERING DESTINATIONS](#)" (page 4-16).
- After touching the [Speaker] key, you can touch the [Speaker Volume] key to adjust the volume of the speaker. The speaker volume changes each time the [Speaker Volume] key is touched. Adjust the volume to the desired level.

## 3 Wait until the connection is made and then press the [START] key.

Transmission begins.

### To cancel transmission...

Touch the [Speaker] key before the [START] key is pressed. The line will be disconnected and transmission will stop.

- When the speaker is used, transmission takes place without scanning the original into memory.
- A destination that includes a F-code (sub-address and passcode) cannot be used.
- A one-touch key that has multiple destinations or has a non-fax destination cannot be used.

### System Settings (Administrator): Speaker Settings

The default volume level of the speaker can be changed in the "Speaker Settings".

# SENDING THE SAME FAX TO MULTIPLE DESTINATIONS (Broadcast Transmission)

This function is convenient when you need to send the same fax to multiple destinations, such as sending a report to branch offices in different regions. You can transmit to as many as 500 destinations in one broadcast operation.

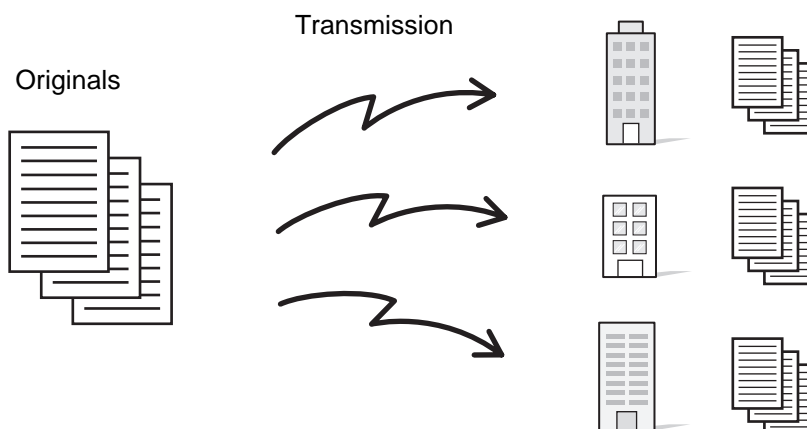

It is convenient to store destinations to which you frequently send faxes by broadcast transmission in group keys. Group dialing allows you to retrieve multiple fax numbers stored in a one-touch key by simply pressing the one-touch key. To store group keys, see "[Address Control](#)" (page 7-17) in "7. SYSTEM SETTINGS".

When a group key is used to dial, the number of fax numbers that are dialed is the number of destinations that are stored in the group key. When a group key that has 10 destinations is used, 10 fax numbers are dialed.

## 1 Place the original.

Place the original face up in the document feeder tray, or face down on the document glass.

☞ [PLACING THE ORIGINAL](#) (page 1-37)

When the original is a different size than the size setting, set the original size.

☞ [SPECIFYING THE SCAN SIZE AND SEND SIZE](#) (page 4-47)

### Enter the destination fax number.

(1) Touch the [Address Book] key in the base screen.

For the [Address Book] key, see "BASE SCREEN OF FAX MODE" (page 4-8).

(2) Touch the one-touch key of the desired destination.

(3) Repeat step (2) until all destinations are selected.

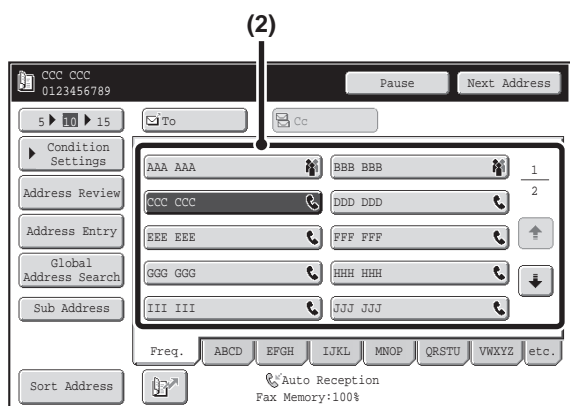

- In addition to specification by one-touch key, a destination can also be specified using a search number. You can also directly enter a fax number with the numeric keys or look up a destination in a global address book. For more information, see "ENTERING DESTINATIONS" (page 4-16).
- It is convenient to use a group key to enter the destinations.
- After entering a destination with the numeric keys, if you wish to enter another destination with the numeric keys, touch the [Next Address] key before entering the next destination. The [Next Address] key can be omitted before or after a destination entered using a one-touch key. However, if "Must Input Next Address Key at Broadcast Setting" is enabled in the system settings (administrator), the [Next Address] key must be touched before entering the next destination.

2

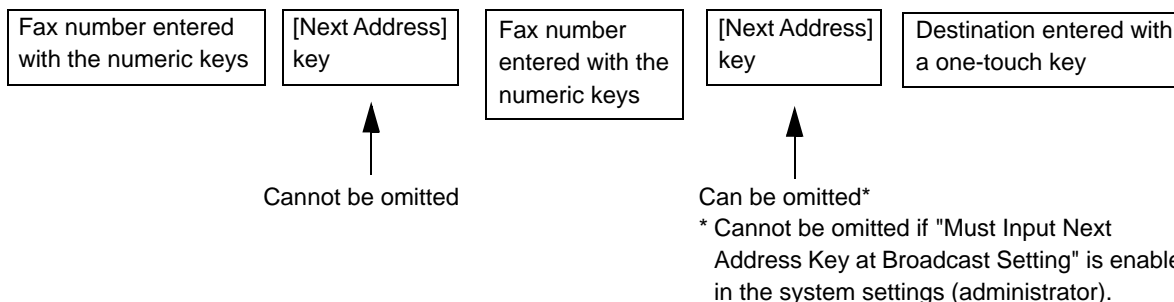

#### System Settings (Administrator): Must Input Next Address Key at Broadcast Setting

This setting is used to prohibit omission of the [Next Address] key when entering destinations for broadcast transmissions.

### Touch the [Address Review] key.

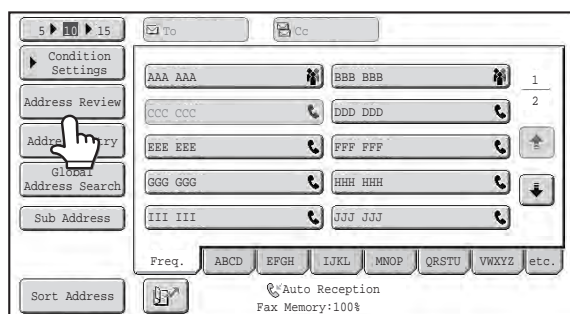

3

4

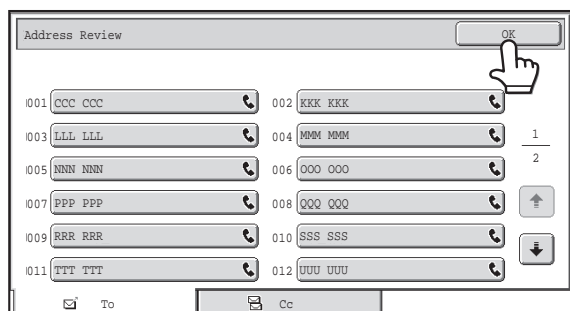

Check the destinations and then touch the [OK] key.



#### To cancel a specified destination...

Touch the key of the destination that you wish to cancel. A message will appear to confirm the deletion. Touch the [Yes] key.

[CHECKING AND DELETING ENTERED DESTINATIONS](#) (page 4-19)

5

### Press the [START] key.

Scanning begins.

- If you inserted the original pages in the document feeder tray, all pages are scanned. A beep will sound to indicate that scanning is finished.
- If you are scanning the original on the document glass, scan each page one page at a time. When scanning finishes, place the next original and press the [START] key. Repeat until all pages have been scanned and then touch the [Read-End] key. A beep will sound to indicate that scanning is finished.



#### To cancel scanning...

Press the [STOP] key (⏹).



- A broadcast transmission takes place by memory transmission only.
- A broadcast transmission can be used in combination with the timer transmission function to transmit at night or any other desired time. A broadcast transmission can also be used in combination with other convenient functions.
- The broadcast transmission can include Scan to E-mail and Internet fax destinations. In this case, the image sent to the Scan to E-mail and Internet fax destinations will be black and white.

## Resending to unsuccessful broadcast transmission destinations

The results of a completed broadcast transmission can be checked in the job status screen. If transmission to any of the destinations failed, resend the fax to those destinations.

1

**JOB STATUS**

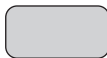

**Press the [JOB STATUS] key.**

2

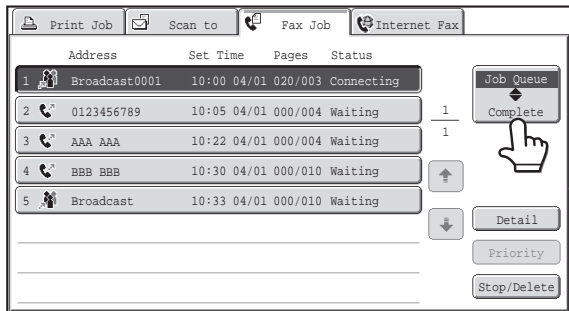

Address	Set Time	Pages	Status
1 Broadcast0001	10:00 04/01 020/003	Connecting	
2 0123456789	10:05 04/01 000/004	Waiting	1
3 AAA AAA	10:22 04/01 000/004	Waiting	1
4 BBB BBB	10:30 04/01 000/010	Waiting	
5 Broadcast	10:33 04/01 000/010	Waiting	

**Touch the [Complete] key.**

If the job status screen of fax mode does not appear, touch the [Fax Job] tab.

 If the broadcast transmission included destinations of different modes, the same broadcast transmission key will appear in each of those modes.

3

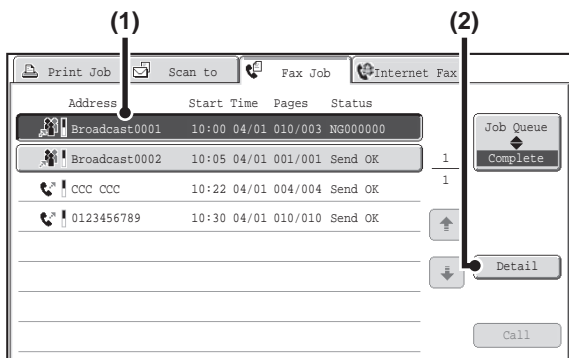

Address	Start Time	Pages	Status
1 Broadcast0001	10:00 04/01 010/003	NG000000	
2 Broadcast0002	10:05 04/01 001/001	Send OK	1
3 CCC CCC	10:22 04/01 004/004	Send OK	1
4 0123456789	10:30 04/01 010/010	Send OK	

**Display details on the broadcast transmission.**

(1) Touch the key of the completed broadcast transmission.

(2) Touch the [Detail] key.

 "Broadcastxxxx" will appear as the destination of the broadcast job key. The job control number that appeared in the touch panel when scanning ended appears in "xxxx".

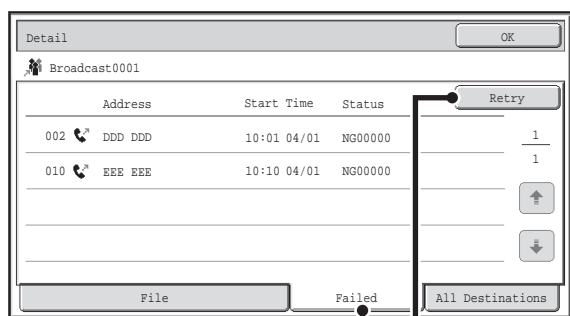

(1) (2)

**Resend to unsuccessful destinations.**

- (1) Touch the [Failed] tab.
- (2) Touch the [Retry] key.

4



- The procedure after the [Retry] key is touched varies depending on whether or not the document filing function was used.

**Not using document filing**

You will return to the base screen with the unsuccessful destinations entered. Place the original and perform the broadcast transmission operation.

**Using document filing**

The document filing operation selection screen will appear with the unsuccessful destinations entered. Perform the document filing resend procedure. (There is no need to rescan the original.)

If the job was stored in a confidential folder or was stored as confidential file, a password entry screen will appear after you touch the [Retry] key. Enter the password.

- If the [All Destinations] key is touched in (1), all destinations will be displayed. The [Retry] key that appears in the screen can be touched to resend to all destinations.

---

---

# SENDING A FAX DIRECTLY FROM A COMPUTER (PC-Fax)

A document in a computer can be transmitted via the machine as a fax. Faxes are sent using the PC-Fax function in the same way as documents are printed. Select the PC-Fax driver as the printer driver on your computer and then select the Print command in the software application. Image data for transmission will be created and sent as a fax.

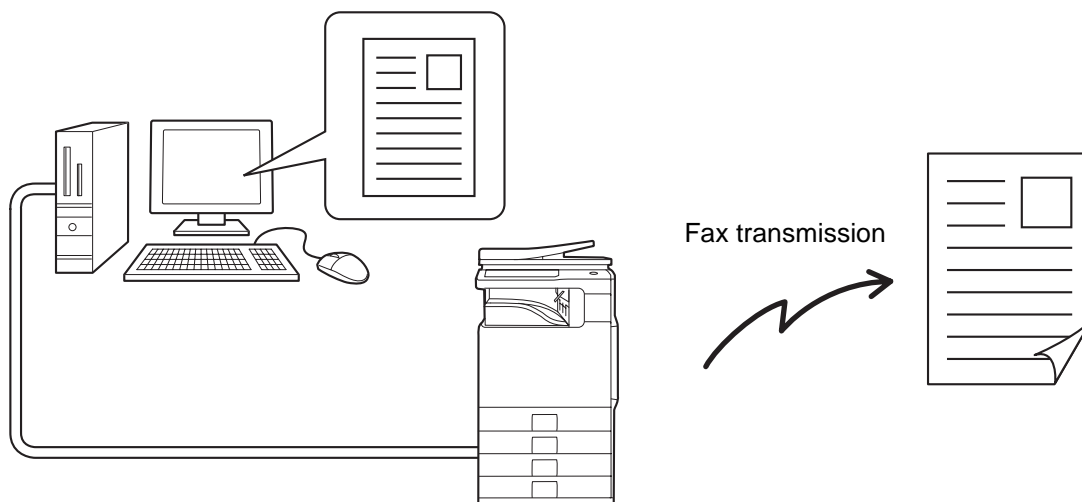

For more information on using PC-Fax, see the Help file for the PC-Fax driver.



- To use the PC-Fax function, the PC-Fax driver must be installed. For more information, see the Start Guide.
- This function can only be used on a Windows® computer.
- This function can only be used for transmission. Faxes cannot be received to your computer.

# IMAGE SETTINGS

Settings for scanning the original are selected in the base screen of each mode. The current state of each setting appears to the right of the key used to select the setting.

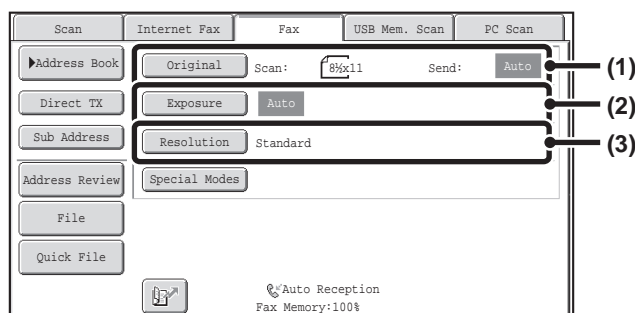

## (1) [Original] key

Touch this key to set the scan size, send size, and orientation of the original, and select 2-sided scanning settings.

[AUTOMATICALLY SCANNING BOTH SIDES OF AN ORIGINAL \(2-Sided Original\)](#) (page 4-46),  
[SPECIFYING THE SCAN SIZE AND SEND SIZE](#) (page 4-47)

## (2) [Exposure] key

Touch this key to select the exposure for scanning.

[CHANGING THE EXPOSURE](#) (page 4-56)

## (3) [Resolution] key

Touch this key to select the scanning resolution.

[CHANGING THE RESOLUTION](#) (page 4-57)



# AUTOMATICALLY SCANNING BOTH SIDES OF AN ORIGINAL (2-Sided Original)

The automatic document feeder will automatically scan both sides of the document.

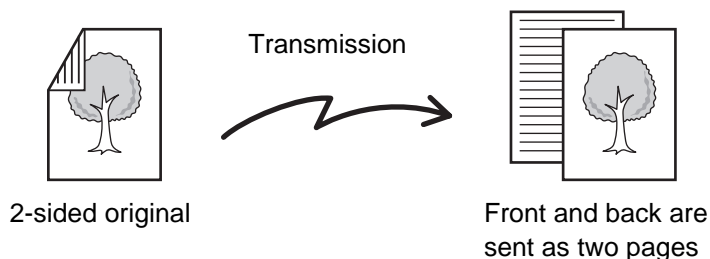

1

## Touch the [Original] key.

[IMAGE SETTINGS](#) (page 4-45)

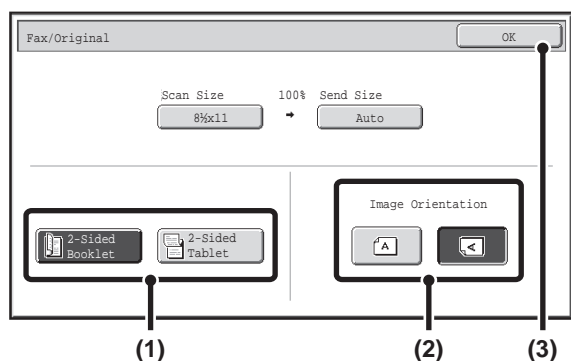

Specify the binding style of the 2-sided original (book or tablet) and the orientation in which the original is placed.

- (1) Touch the [2-Sided Booklet] key or the [2-Sided Tablet] key.

A book and a tablet are bound as shown below.

Booklet



Tablet



- (2) Touch the appropriate [Image Orientation] key.  
If the wrong orientation is selected here, the image may not be sent properly.
- (3) Touch the [OK] key.

2



To cancel 2-sided scanning, touch the highlighted key so that it is no longer highlighted.



- 2-sided scanning automatically turns off after the transmission operation is completed.
- 2-sided scanning is not possible when direct transmission or speaker transmission is performed.

## SPECIFYING THE SCAN SIZE AND SEND SIZE

When the original is placed, the original size and the send size set in the system settings appear in the base screen as the original size and send size.

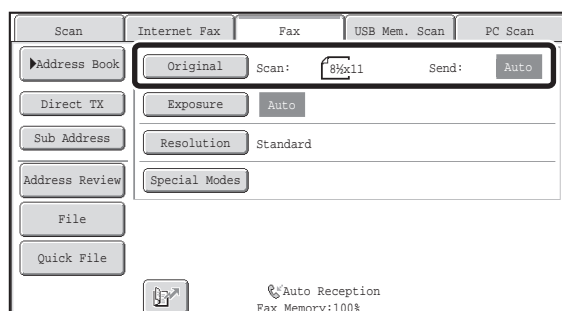

In the above screen, the scan size (the original size) is 8-1/2" x 11" (A4) and the send size is auto. If, for example, the scan size were 8-1/2" x 11" (A4) and the send size were 5-1/2" x 8-1/2" (B5), the image would be reduced before transmission.

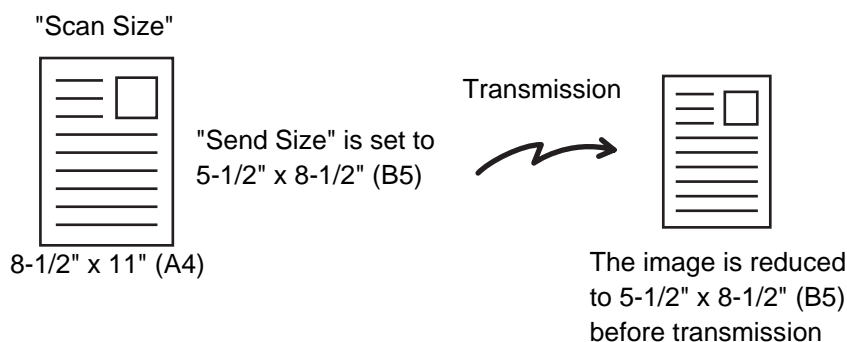

If the size of the placed original is different from the displayed original size, specify the original size.

- [Specifying the original scan size \(by paper size\)](#) (page 4-48)
- [Specifying the original scan size \(by numerical values\)](#) (page 4-51)



- **System Settings (Administrator): Default Original Size Settings**

Set this if you frequently use a particular original size. The set size will appear in the [Original] key. When this setting is configured, changing the original size can be omitted.

- **System settings (Administrator): Setting of Default Original Exit Place (MX-B402SC Only)**

When the automatic document feeder is used, the original's default output destination can be set to the upper exit or the heavy exit. (Except when "Size Input" or "Card Size" is selected for the original size.)

## Specifying the original scan size (by paper size)

If the size of the placed original is different from the displayed original size or you wish to change the original size, you must touch the [Original] key and directly specify the original size. Place the original in the document feeder tray or on the document glass and follow the steps below.

**1**

### Touch the [Original] key.

The original size set in the system settings appears to the right of the [Original] key.

🔗 [IMAGE SETTINGS](#) (page 4-45)

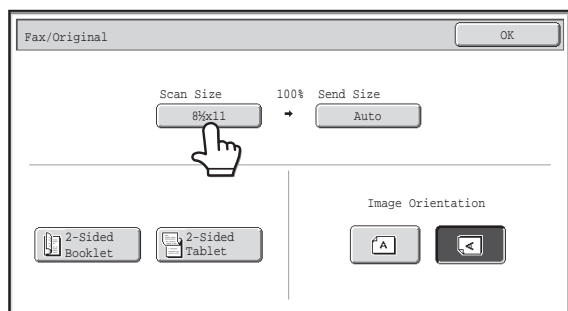
**2**

### Touch the [Scan Size] key.

**MX-B402:**

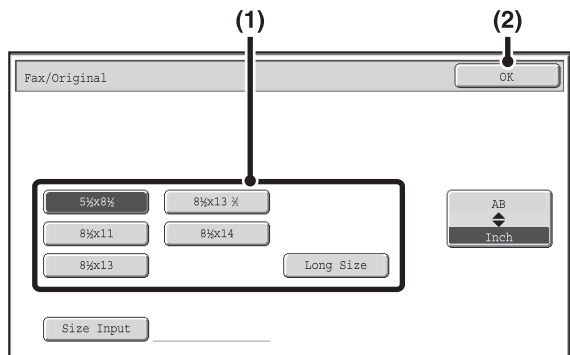

**Specify the scan size.**

- (1) Touch the appropriate original size key.
- (2) Touch the [OK] key.

**MX-B402SC:**

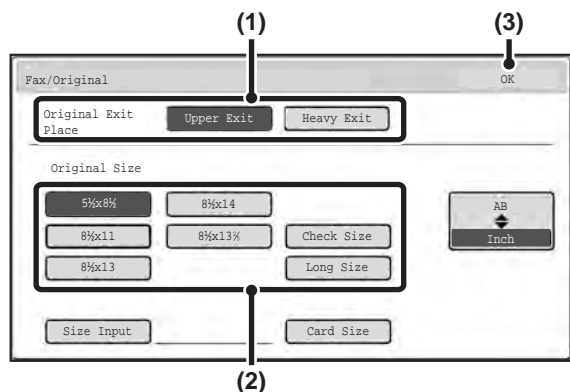

**Specify the scan size.**

- (1) Touch the original output destination.
- (2) Touch the appropriate original size key.
- (3) Touch the [OK] key.



- If you are sending a long original, touch the [Long Size] key. Use the automatic document feeder to scan a long original. The maximum length that can be scanned is 19-5/8" (500 mm) (the maximum height is 8-1/2" (216 mm)).
- To specify an AB size for the scan size, touch the [AB ⇄ Inch] key to highlight the [AB] side and then specify the scan size.

**MX-B402SC Only**

- In the situations below, the original exit place is fixed to the heavy exit.
  - When "Card Size" is selected
  - When the original guide is set to 2 7/8" (74 mm) or lower (Except when "Check Size" is selected)
  - When the automatic document feeder is scanning an original with an X (horizontal) value of 4 1/8" (105 mm) or less
- When "Card Size" is selected, you cannot copy if the original guide is set to 2 7/8" (74 mm) or higher.

4

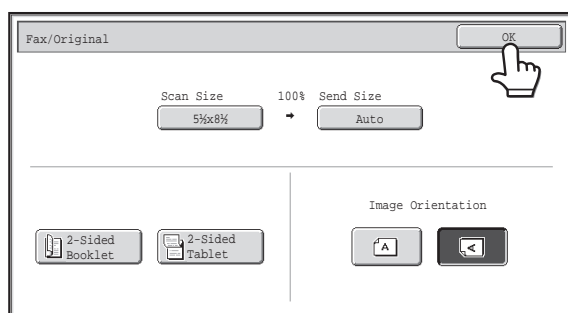

Touch the [OK] key.



When [Long Size] is selected, the 2-sided scanning setting and send size cannot be changed.

## Specifying the original scan size (by numerical values)

When scanning a non-standard size original such as a postcard or card, follow these steps to specify the original size.

1

### Touch the [Original] key.

The original size set in the system settings appears to the right of the [Original] key.

📖 [IMAGE SETTINGS](#) (page 4-45)

2

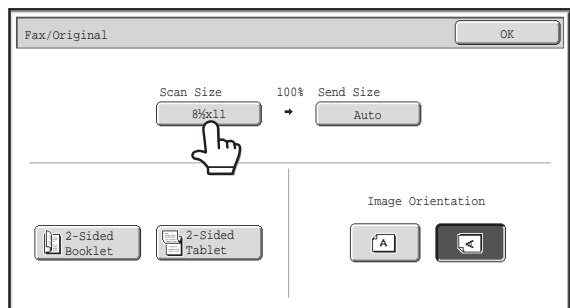

### Touch the [Scan Size] key.

3

**MX-B402:**

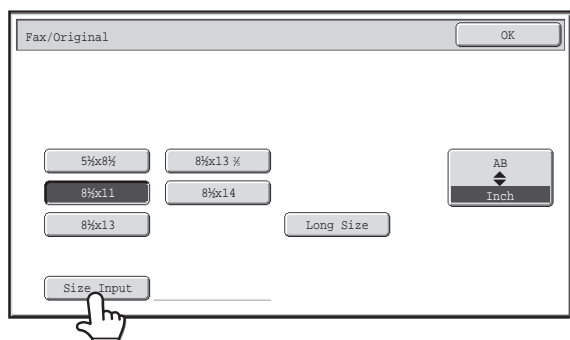

### Touch the [Size Input] key.

**MX-B402SC:**

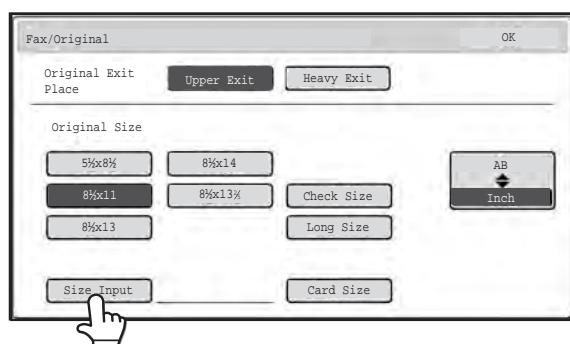

If the [Card Size] key is touched, "X86 Y54" is set in [Size Input]. (MX-B402SC)

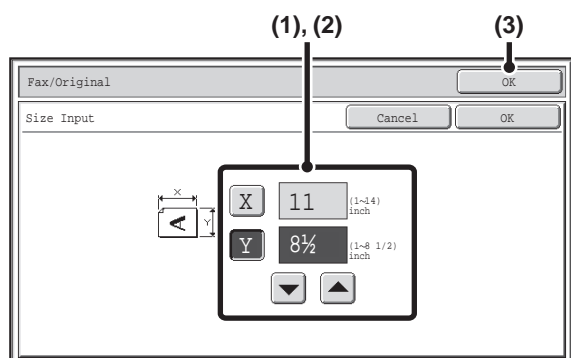

## Enter the scan size.

### (1) Enter the X (horizontal) dimension of the original.

With the [X] key highlighted, enter the X (horizontal) dimension of the original with the  $\blacktriangledown$   $\blacktriangle$  keys. When the document glass is used, enter a number from 1" to 11-5/8" (25 mm to 297 mm).

#### MX-B402:

When the automatic document feeder is used, enter a number from 3-1/2" to 14" (89 mm to 356 mm).

When a number which is from 5-3/8" (139 mm) and less is entered in 2-Sided scanning setting, an original cannot be scanned.

If the horizontal dimension of the original is less than 3-1/2" (89 mm), use the document glass.

#### MX-B402SC:

When the automatic document feeder is used, enter a number from 3-1/4" to 14" (85 mm to 356 mm).

When a number which is from 3-1/8" (84 mm) and less is entered in 2-Sided scanning setting, an original cannot be scanned.

If the horizontal dimension of the original is less than 3-1/4" (85 mm), use the document glass.

### (2) Enter the Y (vertical) dimension of the original.

Touch the [Y] key and enter the Y (vertical) dimension of the original with the  $\blacktriangledown$   $\blacktriangle$  keys. When the document glass is used, enter a number from 1" to 8-1/2" (25 mm to 216 mm).

#### MX-B402:

When the automatic document feeder is used, enter a number from 4" to 8-1/2" (100 mm to 216 mm).

If the vertical dimension of the original is less than 4" (100 mm), use the document glass.

#### MX-B402SC:

When the automatic document feeder is used, enter a number from 2" to 8-1/2" (51 mm to 216 mm).

If the vertical dimension of the original is less than 2" (51 mm), use the document glass.

### (3) Touch the [OK] key.

To complete the setting and return to the screen of step 3, touch the [OK] key next to the [Cancel] key.



#### MX-B402:

- When a number from 11-3/4" to 14" (298 mm to 356 mm) to the X (horizontal) dimension and a number from 1" to 3-7/8" (25 mm to 99 mm) to the Y (vertical) dimension are entered at the same time, an original cannot be scanned.

#### MX-B402SC:

- When a number from 11-3/4" to 14" (298 mm to 356 mm) to the X (horizontal) dimension and a number from 1" to 1-7/8" (25 mm to 50 mm) to the Y (vertical) dimension are entered at the same time, an original cannot be scanned.
- When the X (horizontal) value is set to 4 1/8" (105 mm) or lower and the Y (vertical) value is set to 2 7/8" (74 mm) or lower, "Card Size" is automatically selected and the original exit place is fixed to the heavy exit.

5

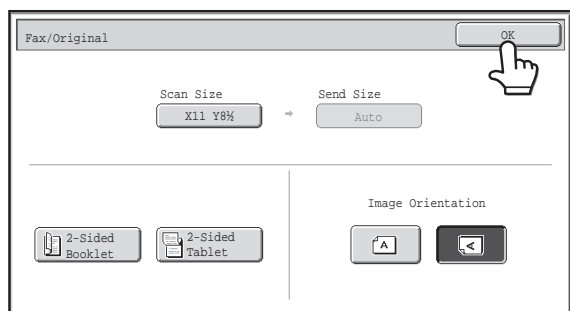

### Touch the [OK] key.

The specified size appears in the [Scan Size] key.

- When the scan size is specified by numerical values, the send size cannot be specified.
- When the automatic document feeder is used, an original longer than 11-5/8" (297 mm) can be scanned (maximum width 19-5/8" (500 mm)). In this case, touch the [Long Size] key in the screen of step 3.
  - [Specifying the original scan size \(by paper size\)](#) (page 4-48)



## Specifying the send size of the original

Specify the send size as a paper size. If a send size bigger than the scan size is selected, the image will be enlarged. If a send size smaller than the scan size is selected, the image will be reduced.

 The send size cannot be specified when [Long Size] is selected for the scan size, or when the scan size is specified by numerical values.

### 1 Touch the [Original] key.

 [IMAGE SETTINGS](#) (page 4-45)

### 2

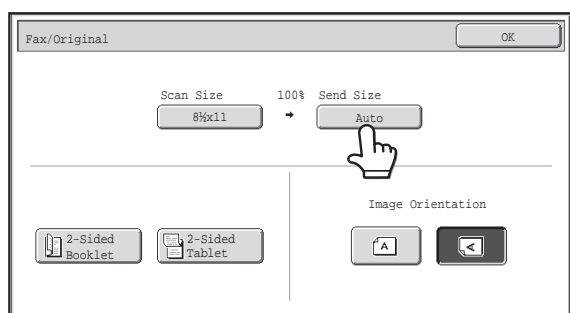

Touch the [Send Size] key.

### 3

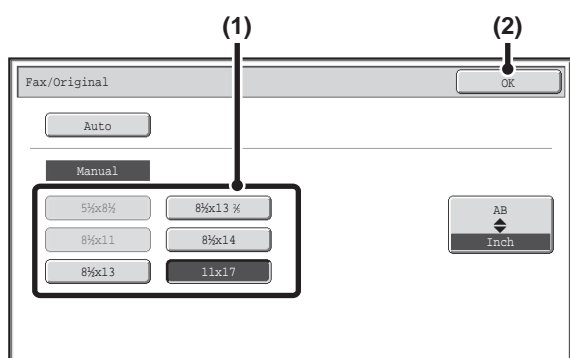

Specify the send size.

- (1) Touch the desired send size key.
- (2) Touch the [OK] key.

-  Depending on the "Scan Size" setting, it may not be possible to select some sizes for the "Send Size". Size keys that cannot be specified for the "Send Size" are grayed out to prevent selection.
- To specify an AB size for the send size, touch the [AB  $\blacklozenge$  Inch] key to highlight the [AB] side and then specify the send size.

4

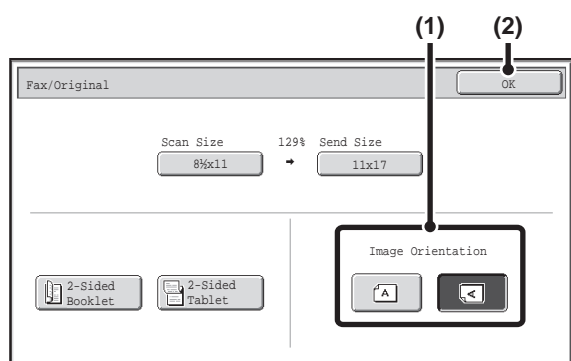

**Specify the orientation in which the original is placed.**

**(1) Touch the appropriate [Image Orientation] key.**

If the wrong orientation is selected here, the image may not be sent properly when using enlargement/reduction.

**(2) Touch the [OK] key.**



The ratio used for reduction or enlargement of the original will appear between the "Scan Size" and the "Send Size".

# CHANGING THE EXPOSURE

The exposure can be changed to match the darkness of the original. Refer to the following tables to select appropriate settings.

## Exposure settings





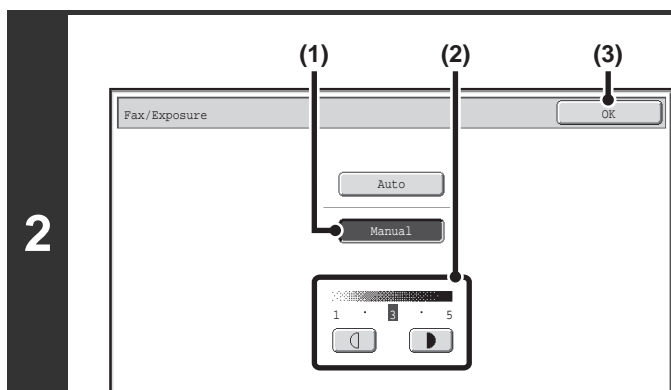

Exposure		When to select
Auto		This setting automatically adjusts the exposure for light and dark parts of the original.
Manual	1-2	Select this setting when the original consists of dark text.
	3	Select this setting for a normal original (neither dark nor light).
	4-5	Select this setting when the original consists of faint text.

### 1 Touch the [Exposure] key.

- 1** The current exposure setting appears to the right of the [Exposure] key.  
 ➤ [IMAGE SETTINGS](#) (page 4-45)



### Select the exposure.

- (1) Touch the [Manual] key.**
- (2) Adjust the exposure with the   keys.**  
 When the exposure is set to [Auto], the   keys cannot be used.  
 The exposure darkens when the  key is touched, and lightens when the  key is touched.  
 To return to auto exposure adjustment, touch the [Auto] key.
- (3) Touch the [OK] key.**

 When using the document glass to scan multiple original pages, the exposure setting can be changed each time you change pages. When using the automatic document feeder, the exposure setting cannot be changed once scanning has begun. (However, when "Job Build" in the special modes is used, the exposure can be changed each time a new set of originals is inserted.)

 **System Settings (Administrator): Default Exposure Settings**  
 This is used to change the default exposure setting.

# CHANGING THE RESOLUTION

The resolution can be selected to match the characteristics of the original, such as text or photo, the size of the text, and the darkness of the image.

Refer to the following tables to select appropriate settings.

## Resolution settings

Resolution	When to select
Standard	Select this setting when your original consists of normal-sized text (like the text in this manual).
Fine	Select this setting when your original has small text or diagrams with fine lines. The original will be scanned at twice the resolution of the [Standard] setting.
Super Fine	Select this setting when your original has intricate pictures or diagrams. A higher-quality image will be produced than with the [Fine] setting.
Ultra Fine	Select this setting when your original has intricate pictures or diagrams. This setting gives the best image quality. However, transmission will take longer than with the other settings.
Half Tone	Select this setting when your original is a photograph or has gradations of color (such as a color original). This setting will produce a clearer image than [Fine], [Super Fine], or [Ultra Fine] used alone. Halftone cannot be selected when [Standard] is used.

1

### Touch the [Resolution] key.

The current resolution setting appears to the right of the [Resolution] key.

 [IMAGE SETTINGS](#) (page 4-45)

2

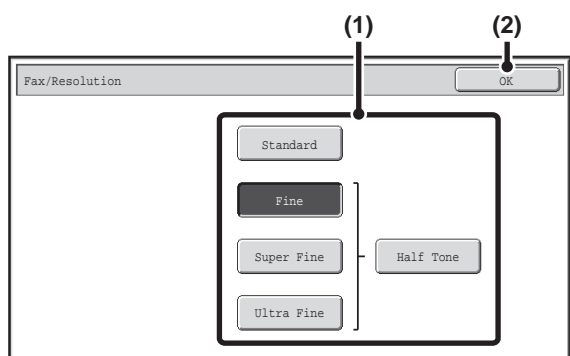

### Select the resolution.

(1) Touch the key of the desired resolution.

(2) Touch the [OK] key.



When [Fine], [Super Fine], or [Ultra Fine] is selected, the [Half Tone] key can be touched to select halftone.



- When using the document glass to scan multiple original pages, the resolution setting can be changed each time you change pages. When using the automatic document feeder, the resolution setting cannot be changed once scanning has begun. (However, when "Job Build" in the special modes is used, the resolution can be changed each time a new set of originals is inserted.)
- When a fax is sent at [Ultra Fine], [Super Fine], or [Fine] resolution, a lower resolution will be used if the receiving machine does not have that resolution.



#### System Settings (Administrator): Initial Resolution Setting

This is used to change the default resolution setting.

# CHECKING THE IMAGE TO BE TRANSMITTED (Preview)

## MX-B402SC

If you touch the [Preview] key before scanning the original, you can check the scanned image in the touch panel before sending the image.

\* The factory default setting is disabled.

 Depending on the size of the transmission data, part of the preview image may not appear in the preview screen in the touch panel.

### 1

## Place the original.

Place the original face up in the document feeder tray, or face down on the document glass.

### 2

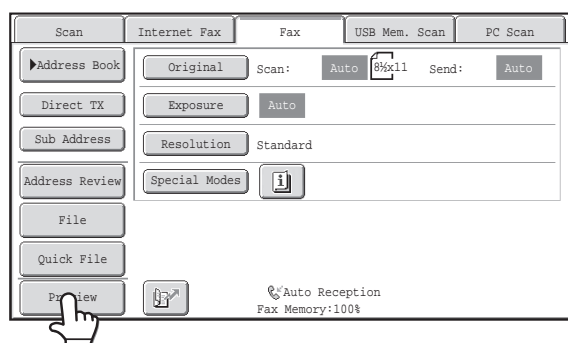

Touch the [Preview] key to highlight it.

### 3

## Select transmission settings and press the [START] key.

"Originals are being read" appears while the originals are being scanned, and when scanning is finished, the preview screen appears on the touch panel. Transmission will not take place until you touch the [Start Sending] key in the preview screen.

### 4

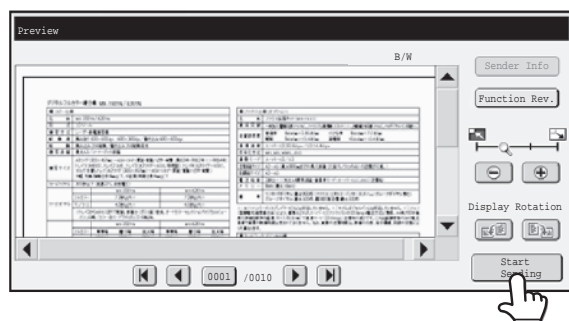

Check the preview image and then touch the [Start Sending] key.

Transmission begins.

For information on the preview screen, see "[PREVIEW CHECK SCREEN](#)" (page 4-59).

 **System settings (administrator): Default Preview**  
You can specify whether or not the [Preview] key function will be enabled in the base screens of the image send modes and in the address book.

# PREVIEW CHECK SCREEN

This section explains the preview check screen.

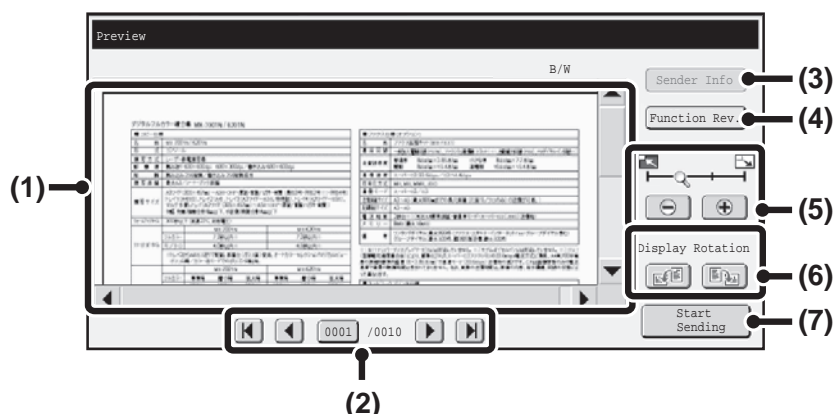

## (1) Preview image

A preview of the scanned original appears.  
If the image is cut off, use the scroll bars at the right and bottom of the screen to scroll the image. Touch a bar and slide it to scroll. (You can also touch the keys to scroll.)

## (2) Change page keys

When there are multiple pages, use these keys to change pages.

- keys: Go to the first or the last page.
- keys: Go to the previous page or the next page.
- Page number display:  
This shows the total number of pages and the current page number. You can touch the current page number key and enter a number with the numeric keys to go to that page number.

## (3) [Sender Info] key

Touch to display the sender information for fax own number.  
This key can only be touched when the entire preview image is displayed in the preview screen.

## (4) [Function Rev.] key

Touch to check special mode settings or scan settings for two-sided originals.

## (5) Display zoom key

Use this to set the zoom ratio of the displayed image. Changes from the left in the order "Full Page", "Twice", "4 Times", "8 Times". The setting applies to all pages in the file, not just the displayed page.

## (6) "Display Rotation" key

This rotates the image right or left by 90 degrees. The rotation applies to all pages in the file, not just the displayed page.

## (7) [Start Sending] key

Touch to begin transmission.



- A preview image is an image for display on the touch panel. It will differ from the actual send result.
- The preview image reflects certain scanning and special mode settings. Settings reflected in the preview image are as follows:  
Scanning settings: Original  
Special modes: Erase, Card Shot

# FAX RECEPTION



This section explains the basic procedures for receiving faxes.

## RECEIVING FAXES

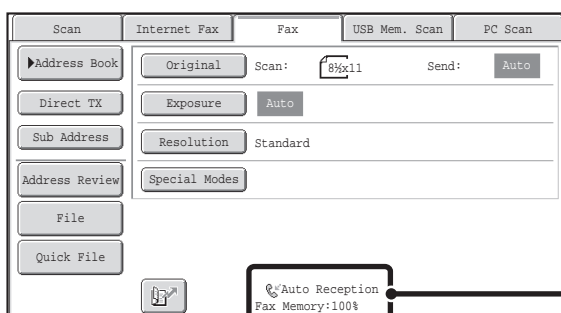
When the reception mode is set to "Auto Reception", the machine will receive and print faxes automatically. The fax reception mode is displayed in the base screen.



This shows the current fax reception mode and the amount of free memory remaining.

- 
 • When fax reception is in progress, it is possible to reserve a transmission by performing the transmission in memory transmission mode.  
 ➤ [TRANSMISSION METHODS](#) (page 4-25)
- When a fax smaller than 8-1/2" x 11" (A4) size is received, the size of the paper used for printing will vary depending on the orientation (vertical or horizontal) in which the sender placed the original.
- 
 • **System Settings: Receive Setting** (page 7-106)  
 This is used to change the fax reception mode. "Auto Reception" should normally be used. Select "Manual Reception" when an extension phone is connected to the machine.
- **System Settings (Administrator): Allow/Reject Number Setting**  
 You can store numbers and specify whether or not reception is allowed from those numbers.

# RECEIVING A FAX

When a fax is transmitted to the machine, the machine automatically receives and prints the fax.

1

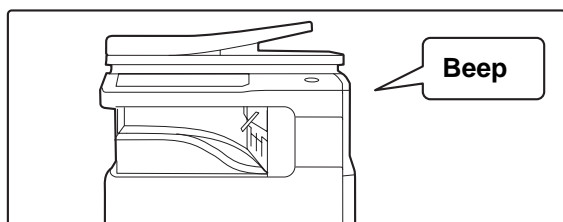

## The machine rings and fax reception begins automatically.

A beep sounds when reception ends.



- **System Settings (Administrator): Speaker Settings**

This is used to change the volume and tone of the reception beep.

- **System Settings (Administrator): Number of Calls in Auto Reception**

This is used to change the number of rings on which fax reception begins automatically. To receive faxes without the machine ringing, select "0" rings.

2

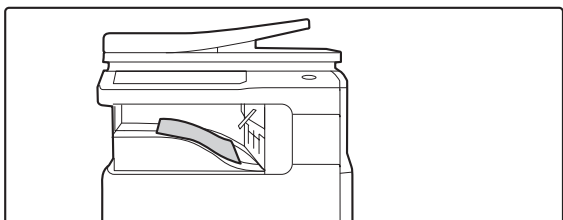

## The fax is automatically printed.



- **If a password entry screen appears...**

A password must be entered to print the received fax. When the correct password is entered, the received fax is printed.

➤ [PRINTING A PASSWORD-PROTECTED FAX \(Hold Setting For Received Data Print\)](#) (page 4-63)

- **Stapling (when a finisher is installed) can be selected.**

When printing received data, you can specify the number of copies and staple settings.



- If printing of a copy job or print job is in progress when a fax is received, the fax will not be printed until the previously reserved job is completed.
- Received faxes will not be printed when the machine cannot print due to an error condition such as out of paper, out of toner, or a paper misfeed. The faxes will be printed automatically when the error condition is cleared. (If the machine ran out of paper, touch the [OK] key in the touch panel after loading paper.)
- When received faxes cannot be printed, the faxes can be forwarded to another fax machine.  
➤ [FORWARDING RECEIVED FAXES \(Fax Data Forward\)](#) (page 4-66)
- If stapling is enabled when a finisher is installed, stapling will take place at the position indicated below on the paper.

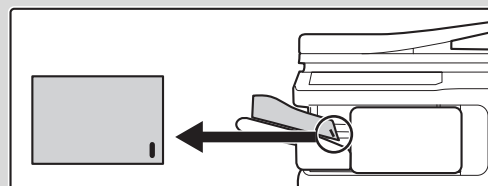

- **System Settings (Administrator): Duplex Reception Setting**

This is used to have received faxes printed on both sides of the paper.

- **System Settings (Administrator): Receiving Date & Time Print**

Use this to select whether or not the date and time of reception is added when a received image is printed.



## RECEIVING A FAX MANUALLY

A fax can be received manually using the touch panel. While the machine rings, touch the [Speaker] key in the base screen and then touch the [Fax Manual Reception] key that appears.

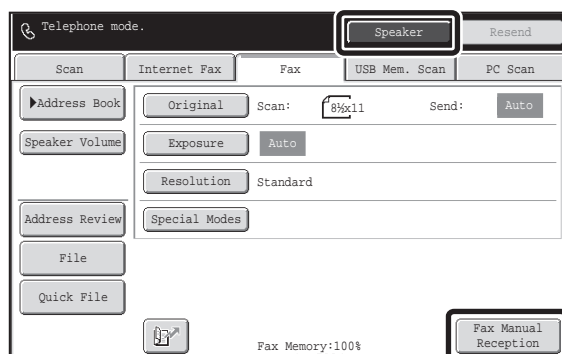



- When a call is answered by touching the [Speaker] key, you will be able to hear the other party, however, you will not be able to speak.
- Even when you use an extension phone to answer a call, you can touch the [Fax Manual Reception] key in the touch panel to begin fax reception. You can also use the extension phone to begin fax reception.
  - [RECEIVING A FAX AFTER ANSWERING A CALL ON THE EXTENSION PHONE \(Remote Reception\)](#) (page 4-118)

# PRINTING A PASSWORD-PROTECTED FAX (Hold Setting For Received Data Print)

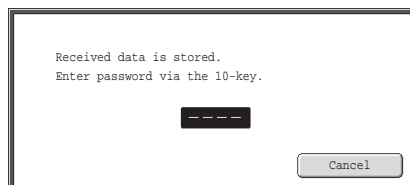

"Hold Setting for Received Data Print" can be enabled in the system settings (administrator) to have faxes received to memory without being printed. To print the faxes, a password must be entered. When this function is used, a password entry screen appears in the touch panel when a fax is received.



When the previously programmed 4-digit password is entered with the numeric keys, printing begins.

The [Cancel] key can be touched to close the password entry screen. If this is done, the data in memory key (  ) will blink in the touch panel. The password entry screen will reappear when you touch the blinking key (  ) or change modes.

When "Received Data Image Check Setting" is enabled in the system settings (administrator), a password can be entered to display the received data list screen. If you wish to check an image before printing it, continue from step 1 on the next page.

-  • The received faxes will be retained in memory regardless of whether they were received automatically or manually.
-  • If "Fax Data Receive/Forward" is executed in the system settings to forward received faxes to another machine, faxes retained in memory will also be forwarded. At that time, the same password entry screen as for printing will appear. Forwarding will not take place unless the password is entered.

-  **System Settings (Administrator): Hold Setting for Received Data Print**  
Enable this setting to have received faxes retained in memory until a password is entered. This setting is also used to program the password.

# CHECKING THE IMAGE BEFORE PRINTING

When "Received Data Image Check Setting" is enabled\* in the system settings (administrator), you can check a received image in the touch panel before printing it out. When this function is enabled, follow the steps below to print a received image.

\* The factory default setting is disabled.

1

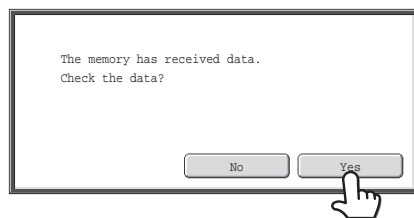

**When an image is received, a confirmation prompt will appear. Touch the [Yes] key.**

If this message appears while you are configuring settings of any type and you touch the [Yes] key, the settings that you are configuring will be cancelled. If this message appears in another mode, you will return to the base screen of image send mode after checking the image.

2

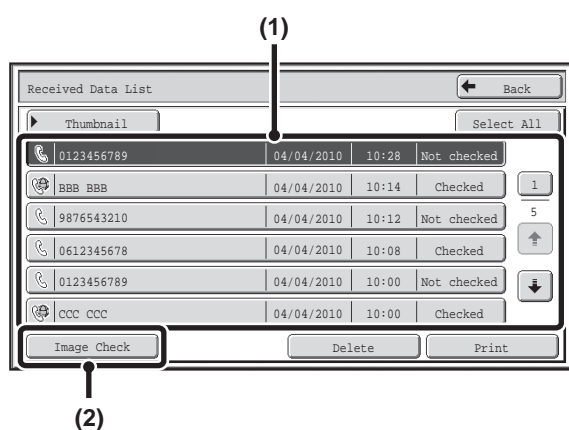

**Select the received image**

**(1) Touch the key of the received image that you want to check.**

Multiple received images can be checked.

**(2) Touch the [Image Check] key.**

- To show thumbnails of the received images, touch the [Thumbnail] key.
- To delete an image that has been selected, touch the [Delete] key. To print an image that has been selected, touch the [Print] key.

3

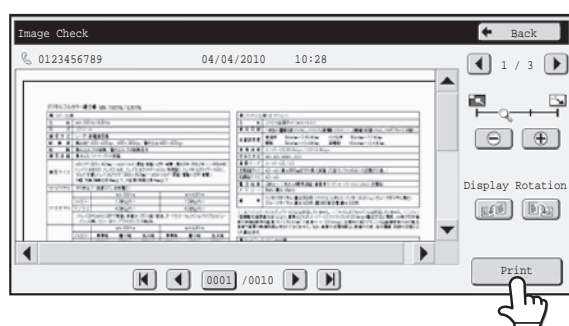

**Check the received image and then touch the [Print] key.**

Printing begins.

For information on the image check screen, see "IMAGE CHECK SCREEN" (page 4-65).

 If the screen of step 1 appears when you are configuring settings in the setting screens of any of the modes, the configured settings will be cancelled if you view the image. After viewing the image, you will return to the base screen of image send mode, regardless of which mode you were in previously.

 **System Settings (Administrator): Received Data Image Check Setting**  
Use this to specify whether or not a received fax can be viewed before it is printed.

# IMAGE CHECK SCREEN

This section explains the image check screen.

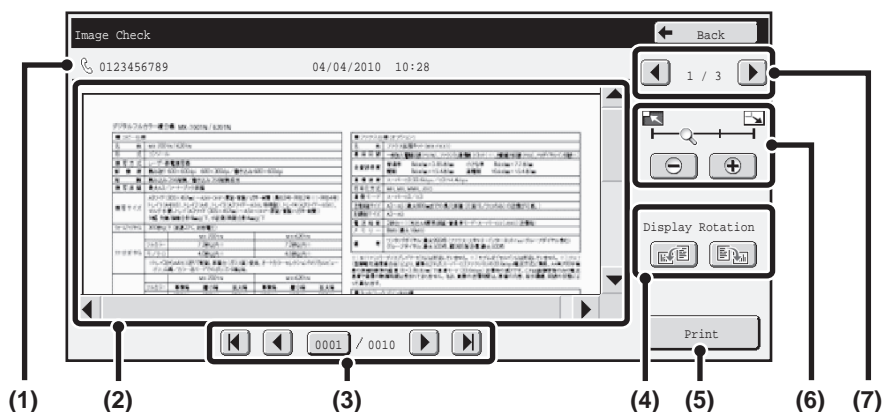

## (1) Information display

This shows information on the displayed image.

## (2) Preview image

An image of the selected received image appears. If the image is cut off, use the scroll bars at the right and bottom of the screen to scroll the image. Touch a bar and slide it to scroll. (You can also touch the keys to scroll.)

## (3) Change page keys

When there are multiple pages, use these keys to change pages.

- keys: Go to the first or the last page.
- keys: Go to the previous page or the next page.
- Page number display: This shows the total number of pages and the current page number. You can touch the current page number key and enter a number with the numeric keys to go to that page number.

## (4) "Display Rotation" key

This key rotates the image right or left by 90 degrees. The rotation applies to all pages in the file, not just the displayed page.

## (5) [Print] key

Touch this key to start printing.

## (6) Display zoom key

Use this key to set the zoom ratio of the displayed image. The setting applies to all pages in the file, not just the displayed page.

## (7) Image select key

When multiple images are selected for preview display, use this key to change the displayed images.



A preview image is an image for display on the touch panel. It will differ from the actual print result.



# FORWARDING RECEIVED FAXES (Fax Data Forward)

When the machine cannot print because it is out of paper or out of toner, received faxes can be forwarded to another previously programmed fax machine.

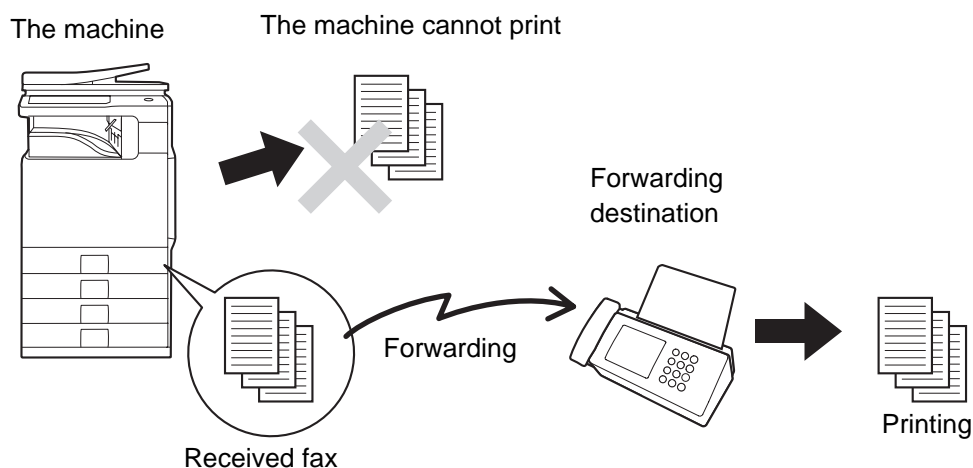
This function is convenient in an office or work area that has two or more telephone lines and another fax machine is connected to a different line than the machine.



Forwarding of received faxes is executed in the system settings of the machine. Press the [SYSTEM SETTINGS] key on the operation panel to display the system setting menu screen in the touch panel. Select [Fax Data Receive/Forward] - [Fax Settings], and then touch the key that executes received fax forwarding.

-  • If some pages of a fax that is being forwarded were successfully printed, only those pages that were not printed will be forwarded.
- A forwarded fax becomes a fax transmission job. If transmission does not take place because the transmission was canceled or an error occurred, the fax will be held in memory until it can be printed.
- Faxes received to a F-code confidential memory box cannot be forwarded.
- If a password entry screen appears after touching the [OK] key, "Hold Setting for Received Data Print" has been enabled. Enter the password with the numeric keys to begin forwarding.  
 [PRINTING A PASSWORD-PROTECTED FAX \(Hold Setting For Received Data Print\)](#) (page 4-63)

-  • **System Settings: Fax Data Receive/Forward (page 7-25)**  
Use this to forward received faxes when the machine is unable to print.
- **System Settings (Administrator): Set the Telephone Number for Data Forwarding**  
This is used to store the forwarding fax number.

# FORWARDING RECEIVED FAXES TO A NETWORK ADDRESS (Inbound Routing Settings)

You can have received faxes automatically forwarded to an e-mail address, file server address, desktop address, or network folder address. This function can be used to forward received faxes to a specified address without printing them.

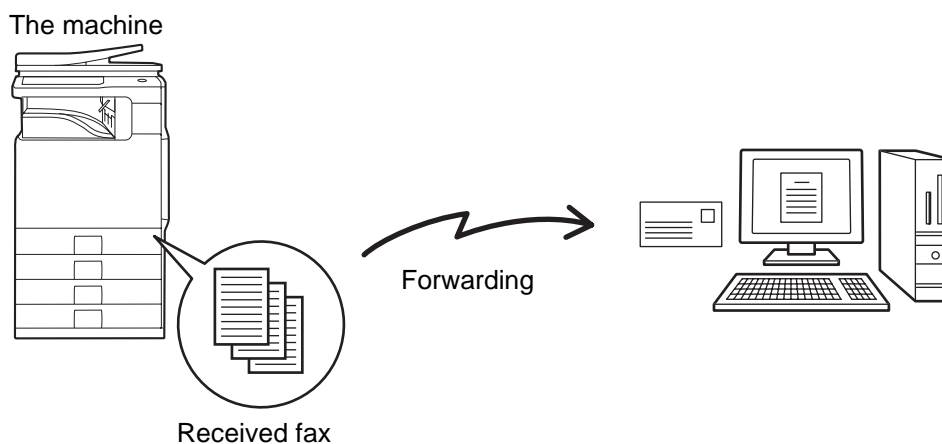

- This function cannot be used for faxes received by confidential reception.
- When faxes forwarded using this function are printed at the forwarding destination, the date and time of reception cannot be printed on the faxes. ("Receiving Date & Time Print" is disabled.)

## CONFIGURING INBOUND ROUTING SETTINGS

All inbound routing settings are configured in the Web pages. For the procedure for accessing the Web pages, see the Start Guide.

The following explanation assumes that the Web pages have been accessed with administrator rights.

To configure inbound routing settings, follow the steps below.

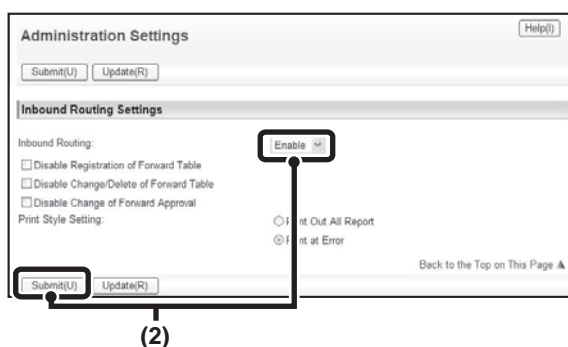

### Enabling the inbound routing function.

- (1) In the Web page menu, click [Application Settings], [Inbound Routing Settings], and then [Administration Settings].
- (2) Select [Enable] in "Inbound Routing" and click the [Submit] button.

Users without administrator rights can be prohibited from storing, editing, and deleting forwarding tables in this screen, and from specifying which table is used. To do so, select the checkboxes below .

- Disable Registration of Forward Table
- Disable Change/Delete of Forward Table
- Disable Change of Forward Approval

When inbound routing is enabled, you can also specify whether or not you wish the machine to print the forwarded faxes.

To have all received faxes printed before being forwarded, select "Print Out All Report" in "Print Style Setting". To have received faxes printed only when an error prevents forwarding, select "Print at Error".

After configuring the settings, be sure to click the [Submit] button.

Sender Number/Address Registration Help()

Address to be Entered:

012345678  
abc@aaa.bbb.ccc

Fax Number:  (Up to 1500 characters)

Internet Fax Address:  (Up to 1500 characters)

[Back to the Top on This Page](#)

(2)

(3)

## Storing sender addresses.

If you wish to have only faxes from specified addresses forwarded, store the desired sender addresses. Sender addresses stored here can be selected from a list when you store a forwarding table.

- (1) Click **[Sender Number/Address Registration]** in the **[Inbound Routing Settings]** menu in the Web page.
- (2) Enter the sender address in "Internet Fax Address" or "Fax Number" as appropriate, and click the **[Add to List]** button.

The entered address will be added to the "Address to be Entered" list.

- Specify whether the address will be directly entered (maximum of 1500 characters) or selected from a global address book by clicking the **[Global Address Search]** button.
- To store multiple addresses, repeat this step.

- (3) When you have finished adding addresses, click the **[Submit]** button.



- A maximum of 500 sender numbers/addresses can be stored.
- To delete an entered address, select the address in "Address to be Entered" and click the **[Delete]** button.

**Table Registration**

Submit(U) Cancel(C)

Table Name: \_\_\_\_\_ (Up 36 characters)

Receive Line Select:  
 Internet Fax  
 Fax

Sender Number/Address Setting:  
 Forward All Received Data  
 Forward Received Data from Below Sender  
 Forward Received Data from Senders except Below

Sender Number/Address: Sender Number/Address to be used in this table.

011112222	011112222
011113333	011113333
022223333	022223333
022224444	022224444
033334444	033334444
033335555	033335555
044445555	044445555
044446666	044446666
ifax@sssss.co.jp	ifax@sssss.co.jp
ifaxaddress@aaaaa.cp.jp	ifaxaddress@aaaaa.cp.jp

Add(Y) Delete(D)

Switch to Single Screen Mode

Forward Destination 1

Forward Condition:  
 Not Forward  
 Always Forward  
 Forward on Selected Day & Time

Day of the Week:  
 Monday  Tuesday  Wednesday  
 Thursday  Friday  Saturday  
 Sunday  
 Select All(S) Clear Checked(Z)

Set Forwarding Time  
 Start Time: 00:00 Hour Minute  
 Completing Time: 00:00 Hour Minute

Format: TIFF(Multi)

Forwarding Destination Settings:  
 Index: All Destina n  
 Display Items: 10

Forward Destination	Name	Type	Address	No.
<input type="checkbox"/>	User A	Internet Fax	tanaka@aaa.bbb.ccc.ddd	2
<input type="checkbox"/>	User B	Mail	suzuki@aaa.bbb.ccc.ddd	3
<input type="checkbox"/>	User C	Internet Fax	wasasa@bbbb	4
<input type="checkbox"/>	User D	Internet Fax	10.20.30.40	5

Total Address: 4  
 Display Previous Page(M) 1/1 Display Next Page(N)

Submit(U) Cancel(C)

## Store a forwarding table.

Follow the steps below to store a forwarding table that combines a specified sender and forwarding address.

(1) Click [Inbound Routing Settings] in the Web page menu and click the [Add] button.

(2) Enter a "Table Name".

(3) Select the line used for reception. (MX-B402SC only)

(4) Select the sender whose faxes will be forwarded.

- To forward all received faxes, select [Forward All Received Data].

### MX-B402

- To forward faxes received from a specific sender only, select [Forward Received Data from Below Sender], select the sender from the list, and then click the [Add] button.

### MX-B402SC

- To forward only data received from specific senders, select [Forward Received Data from Below Sender]. To forward all data except data from specific senders, select [Forward Received Data from Senders except Below]. Select the appropriate senders from the list and click the [Add] button.

(5) Select the forwarding conditions. (MX-B402SC only)

- To always forward received data, select [Always Forward].
- To specify a day and time on which received data will be forwarded, select [Forward on Selected Day & Time] and select the checkbox  of the desired day of the week. To specify a time, select the [Set Forwarding Time] checkbox  and specify the time.

(6) Select the file format.

The format can be set separately for each forwarding address (for each of forwarding addresses 1, 2, and 3 in the table).

(7) Select the forwarding address.

Forwarding addresses can be selected from the machine's address book. (Multiple addresses can be selected.) A maximum of 1000 forwarding addresses can be stored (a combined maximum of 100 file server, desktop, and network folder addresses can be stored).

(8) Click [Submit].



- When selecting senders from the "Sender Number/Address Setting" list, you can use the [Shift] key or the [Ctrl] key on your keyboard to select multiple senders.
- A maximum of 50 forwarding tables can be stored.
- Images sent in TIFF format may not display correctly in some recipient environments. In this event, change the file format to PDF.
- For the MX-B402, If you wish to select a group of addresses for the forwarding destination, you can only select a group that contains e-mail addresses only.
- For the MX-B402SC, up to three forwarding day and time settings can be set for one forwarding table, and a forwarding destination can be set for each set time. To configure these settings, use the forwarding list tabs to access each setting.



(2)

**Inbound Routing Settings**

Submit(L) Update(R) Login(P) Help(O)

Inbound Routing Settings: Enable  
Display Items: 10

Table Name	Forward Condition
<input type="checkbox"/> Table 1	Forward Destination 1 <input type="radio"/> Not Forward <input type="radio"/> Always Forward <input type="radio"/> Forward on Selected Day & Time
	Forward Destination 2 <input type="radio"/> Not Forward <input type="radio"/> Always Forward
	Forward Destination 3 <input type="radio"/> Not Forward <input type="radio"/> Always Forward
<input type="checkbox"/> Table 2	Forward Destination 1 <input type="radio"/> Not Forward <input type="radio"/> Always Forward <input type="radio"/> Forward on Selected Day & Time
	Forward Destination 2 <input type="radio"/> Not Forward <input type="radio"/> Always Forward
<input type="checkbox"/> Table 3	Forward Destination 1 <input type="radio"/> Not Forward <input type="radio"/> Always Forward <input type="radio"/> Forward on Selected Day & Time
	Forward Destination 2 <input type="radio"/> Not Forward <input type="radio"/> Always Forward
	Forward Destination 3 <input type="radio"/> Not Forward <input type="radio"/> Always Forward

Total Table 3  
Previous(M) 1/1 Next(N)  
Select All(S) Clear Checked(Z)  
Delete(O) Add(Y)  
Submit(L) Update(R) Back to the Top on This Page A

(3)

## Specifying forwarding tables to be used.

To use the inbound routing function, enable the forwarding tables that you wish to use from among the stored tables.

(1) Click [Inbound Routing Settings] in the Web page menu.

(2) **MX-B402**

Select the "Forward Activated" checkbox of each forwarding table that you wish to use.

**MX-B402SC**

Select [Always Forward] or [Forward on Selected Day & Time] from the forwarding table.

The forwarding permission settings that appear here are linked to the forwarding conditions set in step 3. If you wish to use different forwarding conditions than those set in step 3, set the forwarding permission settings

(3) Click [Submit].



To delete a forwarding table, click the checkbox next to the table name so that it is selected  and click [Delete].

# SPECIAL MODES

This section explains special modes that can be used for fax transmission.

## SPECIAL MODES

When the [Special Modes] key is touched in the base screen, the special modes menu screen appears. The special modes menu consists of two screens. Touch the  $\downarrow$   $\uparrow$  key to switch between the two screens. When the [OK] key is touched in the special modes screen, the selected settings are entered and the base screen reappears.

### 1st screen

MX-B402:

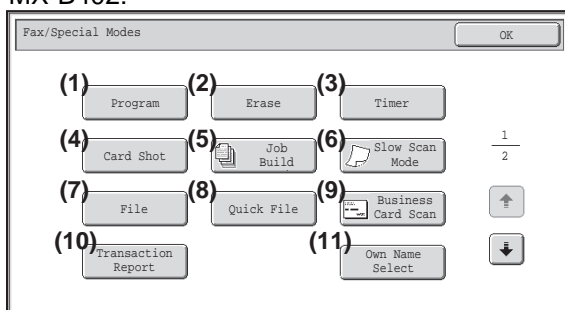

MX-B402SC:

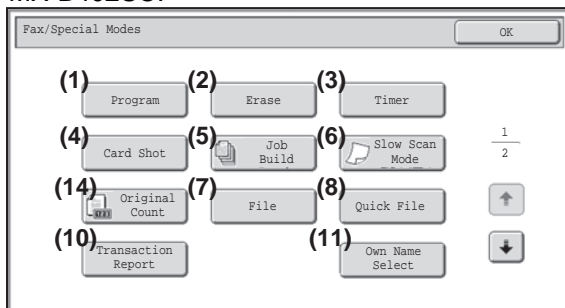

### 2nd screen

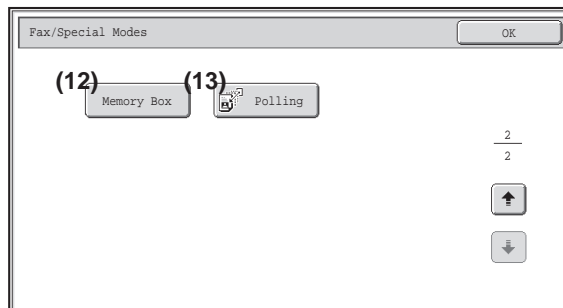
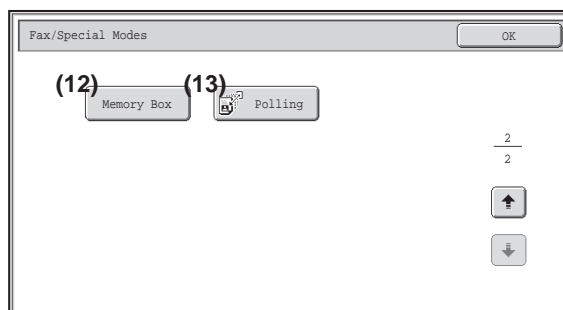

- |   |  |
|---|--|
| <p>(1) <b>[Program] key</b><br/> <a href="#">STORING FAX OPERATIONS (Program)</a> (page 4-73)</p> <p>(2) <b>[Erase] key</b><br/> <a href="#">ERASING PERIPHERAL SHADOWS ON THE IMAGE (Erase)</a> (page 4-75)</p> <p>(3) <b>[Timer] key</b><br/> <a href="#">SENDING A FAX AT A SPECIFIED TIME (Timer)</a> (page 4-77)</p> <p>(4) <b>[Card Shot] key</b><br/> <a href="#">SENDING BOTH SIDES OF A CARD AS A SINGLE PAGE (Card Shot)</a> (page 4-79)</p> <p>(5) <b>[Job Build] key</b><br/> <a href="#">SENDING A LARGE NUMBER OF PAGES (Job Build)</a> (page 4-82)</p> | <p>(6) <b>[Slow Scan Mode] key</b><br/> <a href="#">FAXING THIN ORIGINALS (Slow Scan Mode)</a> (page 4-84)</p> <p>(7) <b>[File] key</b><br/>           Touch this key to use the File function of document filing mode.</p> <p>(8) <b>[Quick File] key</b><br/>           Touch this key to use the Quick File function of document filing mode.</p> <p>(9) <b>[Business Card Scan] key*</b><br/> <a href="#">SENDING BUSINESS CARDS (Business Card Scan)</a> (page 4-88)</p> <p>(10) <b>[Transaction Report] key</b><br/> <a href="#">CHANGING THE PRINT SETTINGS FOR THE TRANSACTION REPORT (Transaction Report)</a> (page 4-89)</p> |
|---|--|

**(11) [Own Name Select] key**

☞ TEMPORARILY CHANGING THE SENDER INFORMATION (Own Name Select) (page 4-92)

**(12) [Memory Box] key**

☞ SENDING A FAX WHEN ANOTHER MACHINE POLLS YOUR MACHINE (Polling Memory) (page 4-96)

\* Only MX-B402

The optional business card feeder must be attached and "Business Card Scan Option" must be enabled in the system settings (administrator).

**(13) [Polling] key**

☞ CALLING A FAX MACHINE AND INITIATING RECEPTION (Polling) (page 4-93)

**(14) [Original Count] key**

☞ CHECKING THE NUMBER OF SCANNED ORIGINAL SHEETS BEFORE TRANSMISSION (Original Count) (page 4-86)

 Special modes can generally be combined with other special modes, however, there are some combinations that are not possible. If a prohibited combination is selected, a message will appear in the touch panel.

## [OK] key and [Cancel] key

In some cases two [OK] keys and one [Cancel] key will appear in the special mode screens. The keys are used as follows:

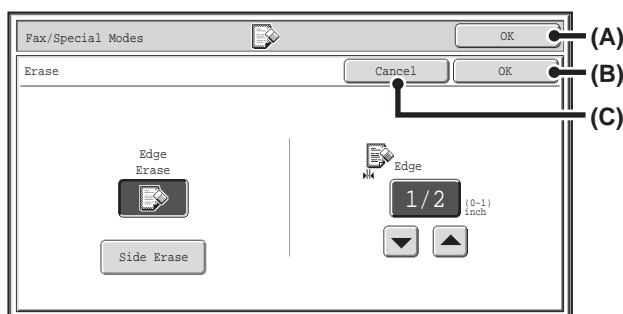

- (A) Enter the selected special mode setting and return to the base screen.
- (B) Enter the selected special mode setting and return to the special modes menu screen. Touch this key when you wish to continue selecting other special mode settings.
- (C) During selection of special mode settings, this key returns you to the special modes menu screen without saving the settings. When settings have been completed, this cancels the settings and returns you to the special modes menu screen.

# STORING FAX OPERATIONS (Program)

A program is a group of transmission settings stored together. When transmission settings are stored in a program, the settings can be retrieved and used for a fax job by means of a simple operation.

For example, suppose that the same 8-1/2" x 11" (A4) size documents are distributed to branch offices in various regions once a month.

(1) The same documents are faxed to each branch office

(2) Smudges on the edges of the documents are erased before transmission

When a job program is not stored	When a job program is stored
<p>Enter the fax numbers of the branch offices.</p> <p style="text-align: center;">↓</p> <p>Select erase settings.</p> <p style="text-align: center;">↓</p> <p>Press the [START] key. The originals are scanned and transmitted.</p>	<p>Retrieve the stored program.</p> <p style="text-align: center;">↓</p> <p>Press the [START] key. The originals are scanned and transmitted.</p>
<p>Considerable time is required to send the documents each month because the above settings must be selected. In addition, mistakes may occasionally be made when selecting the settings, so incorrect transmissions may occur.</p>	<p>When a program is stored, settings are selected with ease by simply pressing the program key. In addition, transmission takes place based on the stored settings so there are no chances for mistakes.</p>



- Programs are stored, edited, and deleted using "Address Control" in the system settings. See "Program" (page 7-23) in "7. SYSTEM SETTINGS".
- Programs can also be stored using the Web pages. Click [Job Programs] and then [Image Send] in the Web page menu.
- The settings stored in a program will be retained even after the program is used for transmission. The same settings can be used repeatedly for transmission.
- The following settings can be stored in programs.
  - Destinations: One-touch keys, group keys, search number
  - Image settings: Original scan size, original orientation, duplex scanning, exposure, resolution
  - Special modes: Polling reception, Erase, Job Build, Slow Scan Mode, Business Card Scan
  - F-code communication: A destination that includes a F-code can be stored to perform a F-code operation.
- Up to 48 programs can be stored.
- Up to 500 destinations can be stored in each program.

## 1 Place the original.

- Place the original in the document feeder tray or on the document glass as appropriate for the functions stored in the program.
- When the original is a different size than the size setting, set the original size.
- ☞ SPECIFYING THE SCAN SIZE AND SEND SIZE (page 4-47)

## 2 Select the special modes.

- (1) Touch the [Special Modes] key.
- (2) Touch the [Program] key.
- ☞ SPECIAL MODES (page 4-71)

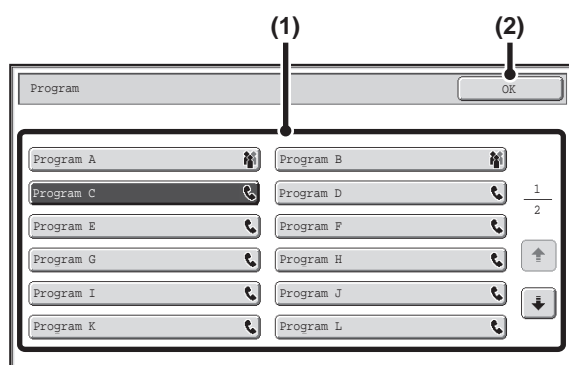

## Retrieve the stored program.

- (1) Touch the desired program key.
- (2) Touch the [OK] key.

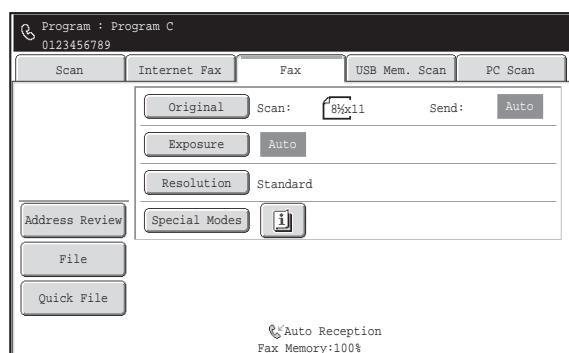

## Select additional settings.

When a program is used, the following settings can be additionally specified:

- Image settings: Original scan size\*, send size
- Special modes: Timer Transmission, Card Shot, File, Quick File, Own Name Select, Transaction Report

\* When stored in the program, this cannot be additionally specified.

- ☞ The screen that appears will vary depending on the destination stored in the program.
- ☞ The mode cannot be changed here.
- ☞ Functions stored in the program cannot be canceled here.

## 5 Press the [START] key.

Scanning begins.

- If you inserted the original pages in the document feeder tray, all pages are scanned. A beep will sound to indicate that scanning is finished.
- If you are scanning the original on the document glass, scan each page one page at a time. When scanning finishes, place the next original and press the [START] key. Repeat until all pages have been scanned and then touch the [Read-End] key. A beep will sound to indicate that scanning is finished.

- ☞ **To cancel scanning...**  
Press the [STOP] key (⏏).

# ERASING PERIPHERAL SHADOWS ON THE IMAGE (Erase)

The erase function is used to erase shadows on images produced when scanning thick originals or books. (This function does not detect shadows and will eliminate everything appearing in the erase area - including shadows, text and images.)

## Scanning a thick book

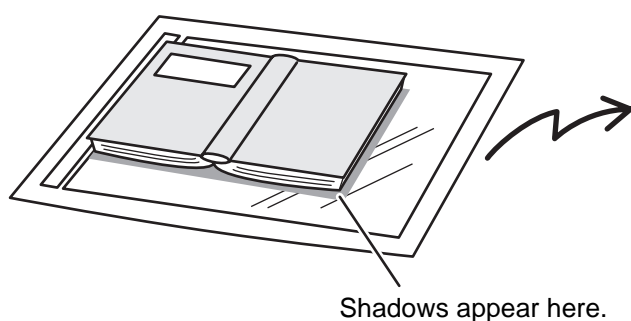

Not using the erase function	Using the erase function
<p>Shadows appear in the image.</p>	<p>No shadows appear.</p>

## Erase modes



### 1 Place the original.

Place the original face up in the document feeder tray, or face down on the document glass.

☞ [PLACING THE ORIGINAL](#) (page 1-37)

When the original is a different size than the size setting, set the original size.

☞ [SPECIFYING THE SCAN SIZE AND SEND SIZE](#) (page 4-47)

### 2 Enter the destination fax number.

☞ [ENTERING DESTINATIONS](#) (page 4-16)

### 3 Select the special modes.

(1) Touch the [Special Modes] key.

(2) Touch the [Erase] key.

☞ [SPECIAL MODES](#) (page 4-71)

## 4

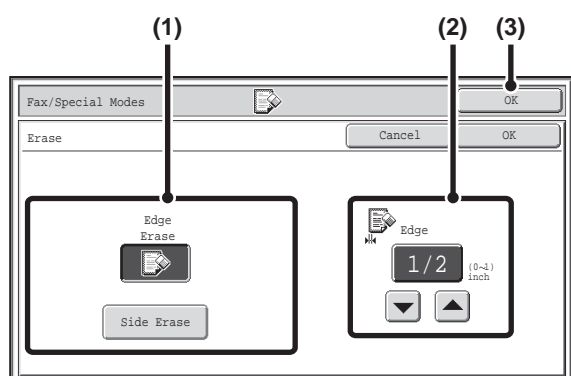

## Select the erase settings.

### (1) Touch the desired erase mode.

Select one of the 2 erase modes.

Touch the [Side Erase] key to open the following screen.

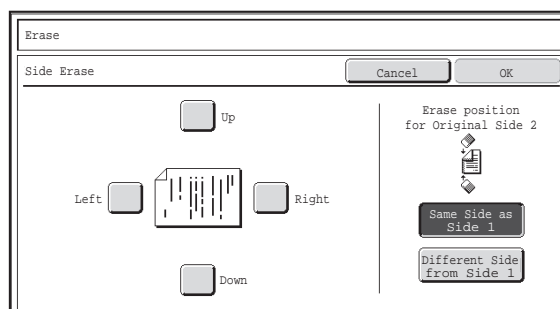

Touch the checkbox of the edge that you wish to erase and make sure that a checkmark (☑) appears.

When performing two-sided scanning, set the erase edge on the reverse side.

- If you touch the [Same Side as Side 1] key, the edge in the same position as on the front side will be erased.
- If you touch the [Different Side from Side 1], the edge in the position opposite to the erased edge on the front side will be erased.

When you have completed the settings, touch the [OK] key.

### (2) Set the erasure width with the keys.

0" to 1" (0 mm to 20 mm) can be entered.

### (3) Touch the [OK] key.

## 5

## Press the [START] key.

Scanning begins.

- If you inserted the original pages in the document feeder tray, all pages are scanned. A beep will sound to indicate that scanning is finished.
- If you are scanning the original on the document glass, scan each page one page at a time.

When scanning finishes, place the next original and press the [START] key. Repeat until all pages have been scanned and then touch the [Read-End] key.

A beep will sound to indicate that scanning is finished.



### To cancel scanning...

Press the [STOP] key (.



When the erase function is used, erase takes place at the edges of the original image. If you also use a reduction or an enlargement setting, the erase width will change according to the selected ratio. For example, if the erase width setting is 1" (20 mm) and the image is reduced to 50%, the erase width will be 1/2" (10 mm).



### To cancel an erase setting...

Touch the [Cancel] key in the screen of step 4.



### System Settings (Administrator): Erase Width Adjustment

The default erase width setting is linked to the copy mode system setting, and can be set from 0" to 1" (0 mm to 20 mm). The factory default setting is 1/2" (10 mm).

# SENDING A FAX AT A SPECIFIED TIME (Timer)

When this function is used, transmission takes place automatically at a specified time.

The timer transmission function makes it easy to perform reserved transmissions, broadcast transmissions and other transmissions at night or other times when phone rates are low.

A timer setting can also be specified for polling reception to receive a fax when you are not present.

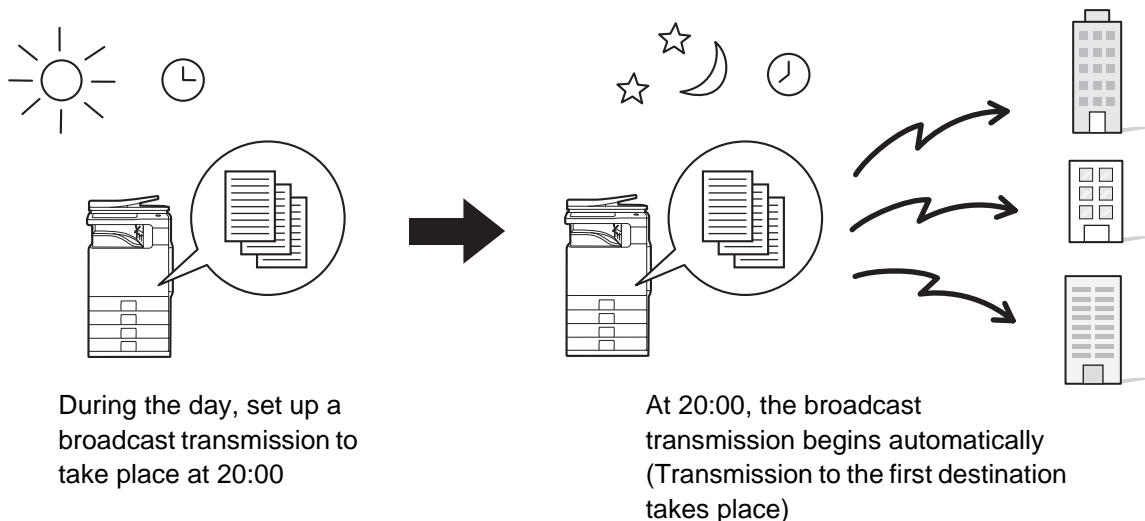

-  When a timer transmission is set, keep the main power switch "on". Transmission will not take place if the main power is turned off at the specified time.
- When performing a timer transmission, you must scan the original into memory when you set up the transmission. It is not possible to leave the document in the auto document feeder or on the document glass and have it scanned at the reserved time of transmission.
- Settings selected for a timer transmission (exposure, resolution, special modes, etc.) are automatically cleared after the transmission is finished. (However, when the document filing function is used, the scanned original and settings are stored on the built-in hard drive.)

## Place the original.

1

Place the original face up in the document feeder tray, or face down on the document glass.

 [PLACING THE ORIGINAL](#) (page 1-37)

When the original is a different size than the size setting, set the original size.

 [SPECIFYING THE SCAN SIZE AND SEND SIZE](#) (page 4-47)

2

## Enter the destination fax number.

 [ENTERING DESTINATIONS](#) (page 4-16)

3

## Select the special modes.

(1) Touch the [Special Modes] key.

(2) Touch the [Timer] key.

 [SPECIAL MODES](#) (page 4-71)



4

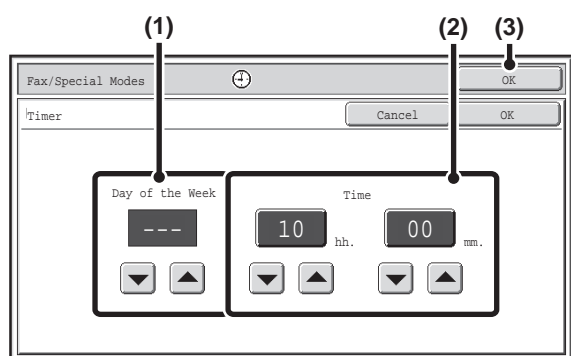

## Set the time with the keys.

### (1) Specify the day.

If you do not wish to specify a day, select [---]. In this case, transmission will begin when the time specified in (2) arrives.

### (2) Specify the time (hour, minute)

Select the time in 24-hour format.

You can also directly touch a numeric display key to change the setting with the numeric keys.

### (3) Touch the [OK] key.



When this screen is opened, the setting will show the current time. If the time is not correct, press the [CLEAR ALL] key (CA) to cancel the operation. Correct the time in the system settings and then perform the timer transmission procedure.

[CHECKING THE DATE AND TIME](#) (page 4-6)

5

## Press the [START] key.

Scanning begins.

- If you inserted the original pages in the document feeder tray, all pages are scanned. A beep will sound to indicate that scanning is finished.
- If you are scanning the original on the document glass, scan each page one page at a time. When scanning finishes, place the next original and press the [START] key. Repeat until all pages have been scanned and then touch the [Read-End] key. A beep will sound to indicate that scanning is finished.



- The time can be specified up to a week in advance.
- Up to 94 timer transmissions can be stored at once.
- Only one timer polling operation can be stored at once. If you wish to poll multiple machines, store a serial polling timer operation.
- If another transmission is in progress when the specified time arrives, the timer operation will begin after that transmission is finished.
- Other operations can be performed after a timer transmission is set up.
- This function cannot be used in direct transmission mode or when the speaker is used to dial.
- If a timer transmission is given priority in the job status screen, the time specification is canceled. The transmission will begin as soon as the job in progress is completed.

[GIVING PRIORITY TO A RESERVED FAX JOB](#) (page 4-127)



### To cancel timer transmission...

Touch the [Cancel] key in the screen of step 4.

# SENDING BOTH SIDES OF A CARD AS A SINGLE PAGE (Card Shot)

This function lets you send the front and reverse sides of a card as a single page, without the need to send each side separately.

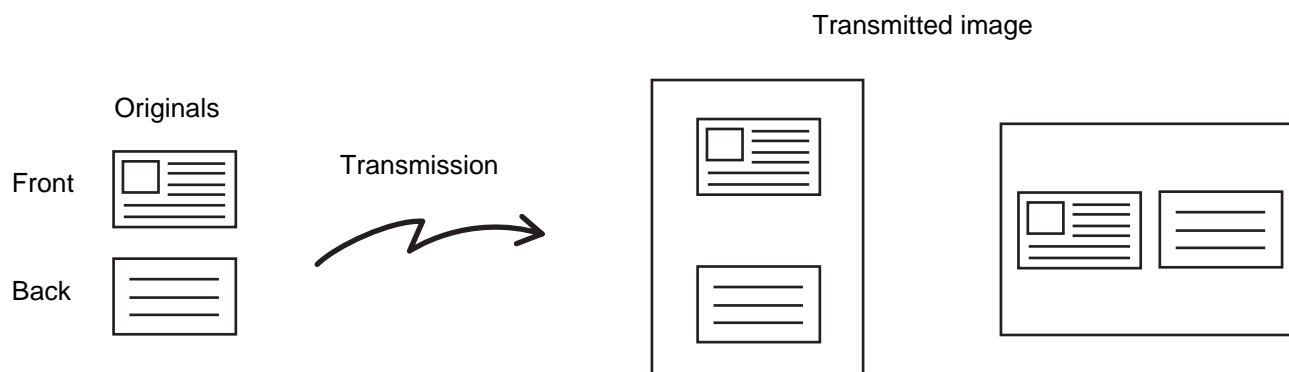

- For the MX-B402, when using card shot, the original must be scanned on the document glass.
- For the MX-B402SC, depending on the card type, some cards cannot be used with the automatic document feeder.

## MX-B402:

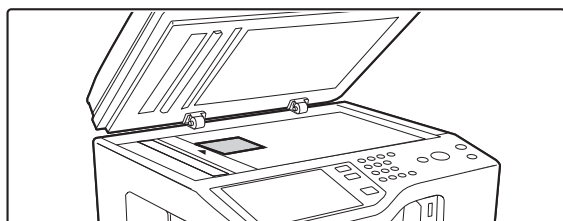

## MX-B402:

Place the original face down on the document glass.

1

## MX-B402SC:

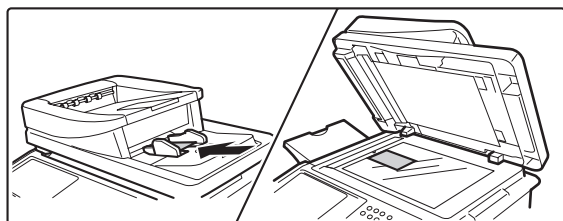

## MX-B402SC:

Place the original face up in the document feeder tray, or face down on the document glass.

When the original is a different size than the size setting, set the original size.

- ☛ [SPECIFYING THE ORIGINAL SCAN SIZE AND SEND SIZE](#) (page 5-56)

2

## Enter the destination fax number.

- ☛ [ENTERING DESTINATIONS](#) (page 4-16)

3

## Select the special modes.

- (1) Touch the [Special Modes] key.
- (2) Touch the [Card Shot] key.

- ☛ [SPECIAL MODES](#) (page 4-71)

4

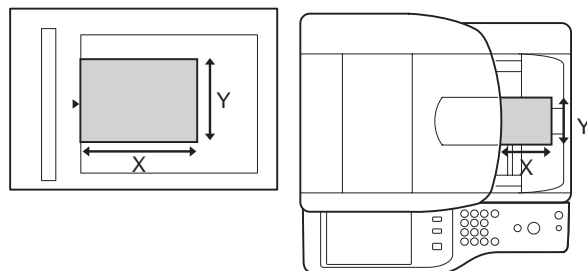
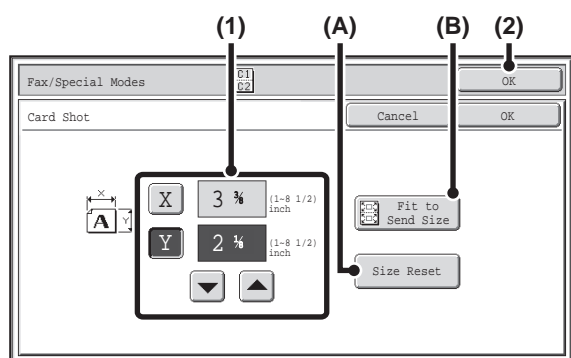

**Specify the original size.**

**(1) Enter the original size.**

- Touch the X (width) numeric value display key and enter the width.
- Touch the Y (height) numeric value display key and enter the height.

- (A) To return the original size to the default size, touch the [Size Reset] key.
- (B) To automatically enlarge or reduce the image size to the send size, touch the [Fit to Send Size] key. Do not touch this key if you wish to scan the original at the original size that you entered.

**(2) Touch the [OK] key.**



- You can also touch the ▲ ▼ keys to change the number.
- The send size is automatically selected based on the original size you entered.
- After selecting Card Shot, you can touch the [Original] key in the base screen to change the original scan size or the send size. In this case, press the [Scan Size] key to display the screen for this procedure. For the procedure for setting the send size, see "[Specifying the send size of the original](#)" (page 4-54).

5

**Press the [START] key to scan the front of the card.**



**To cancel scanning...**  
Press the [STOP] key (⏹).

6

**Turn the card over so that the back is face down, and press the [START] key to scan the back of the card.**



Before scanning the back of the card, you can touch the [Configure] key in the touch panel to change the exposure.



**To cancel scanning...**  
Press the [STOP] key (⏹).

7

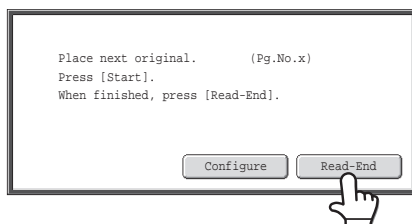

Touch the [Read-End] key.



If you will continue scanning additional cards, you can touch the [Configure] key to change the exposure, resolution, scan size, and send size.



- The ratio cannot be specified and "Rotation Sending Setting" cannot be selected.
- This function cannot be used in direct transmission mode or when the speaker is used to dial.



**To cancel Card Shot...**

Touch the [Cancel] key in the screen of step 4.

# SENDING A LARGE NUMBER OF PAGES (Job Build)

This function lets you separate an original consisting of numerous pages into sets, scan each set using the automatic document feeder, and transmit the pages in a single transmission. Use this function when there are more original pages than can be placed at once in the auto document feeder.

When scanning originals that are separated into sets, scan the set that has the first page first. The settings that you select for the first set can be used for all remaining sets.

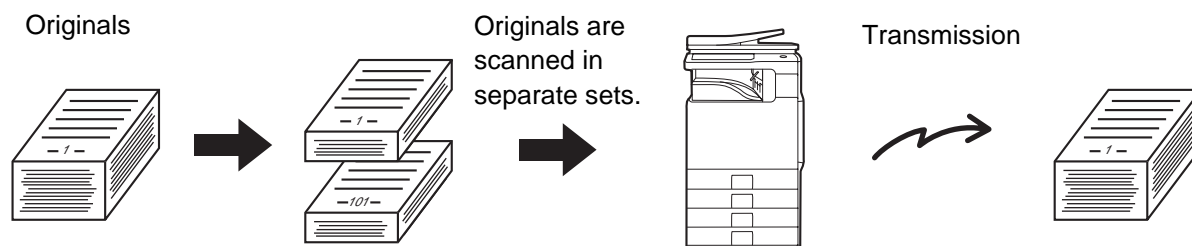

 Up to 999 pages can be scanned. Note that when the memory is being used for other jobs, fewer pages can be scanned.

## MX-B402:

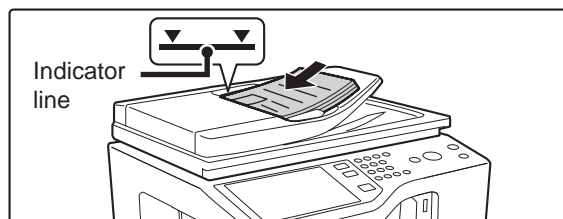

1

## MX-B402SC:

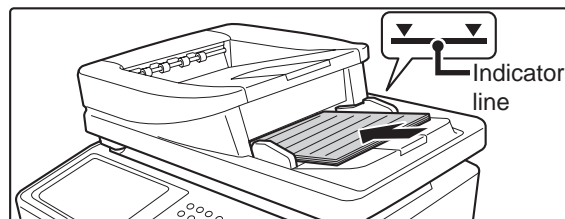

## Insert the originals face up in the document feeder tray.

Insert the originals all the way into the document feeder tray. Multiple originals can be placed in the document feeder tray. The stack of originals must not be higher than the indicator line on the tray.

When the original is a different size than the size setting, set the original size.

 [SPECIFYING THE SCAN SIZE AND SEND SIZE](#) (page 4-47)

2

## Enter the destination fax number.

 [ENTERING DESTINATIONS](#) (page 4-16)

3

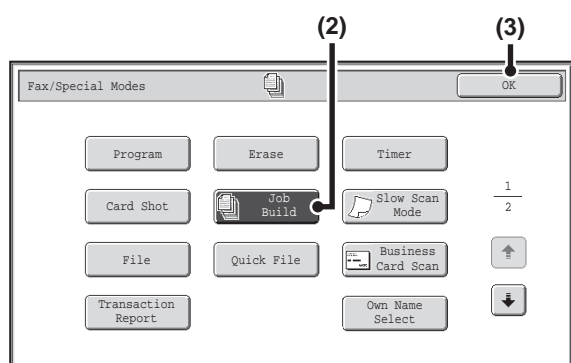

**Select job build mode.**

(1) Touch the [Special Modes] key.  
 ☞ [SPECIAL MODES](#) (page 4-71)

(2) Touch the [Job Build] key so that it is highlighted.

(3) Touch the [OK] key.

4

**Press the [START] key to scan the first set.**

⏪ **To cancel scanning...**  
 Press the [STOP] key (⏹).

5

**Insert the next set of originals and press the [START] key.**

Repeat this step until all originals have been scanned.

⏪ **To cancel scanning...**  
 Press the [STOP] key (⏹). All scanned data will be cleared.

6

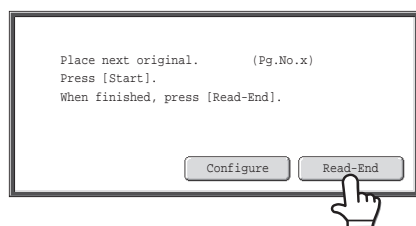

**Touch the [Read-End] key.**

- ✎ • If no action is taken for one minute after the confirmation screen appears, scanning automatically ends and the transmission is reserved.
- ✎ • The [Configure] key can be touched to change the exposure, resolution, scan size, and send size for each original page scanned.



- If the memory becomes full during scanning, a message will appear and the transmission will be canceled.
- This function cannot be used in direct transmission mode or when the speaker is used to dial.



**To cancel Job Build....**  
 Touch the [Job Build] key in the screen of step 3 so that it is not highlighted.

# FAXING THIN ORIGINALS (Slow Scan Mode)

Use this function when you wish to scan thin originals using the automatic document feeder. This function helps prevent thin originals from misfeeding.

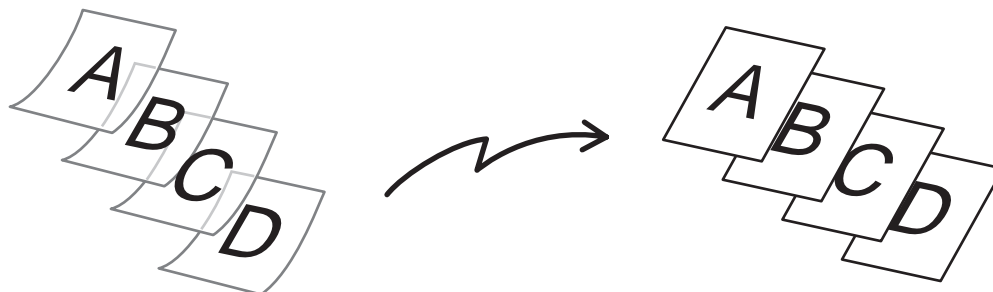

## MX-B402:

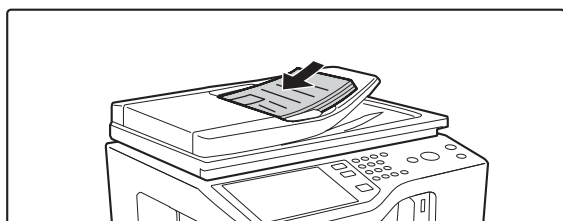

## Insert the originals face up in the document feeder tray.

Adjust the document guides slowly.

When the original is a different size than the size setting, set the original size.

☞ [SPECIFYING THE SCAN SIZE AND SEND SIZE](#) (page 4-47)

## MX-B402SC:

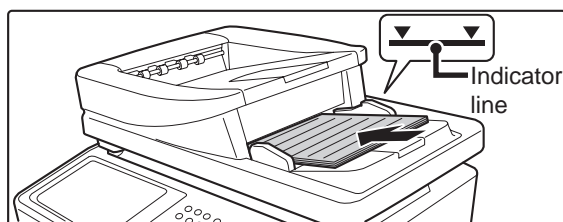

1

✎ If the originals are inserted with too much force, they may crumple and misfeed.

## 2 Enter the destination fax number.

☞ [ENTERING DESTINATIONS](#) (page 4-16)

2

## Select slow scan mode.

(1) Touch the [Special Modes] key.

☞ [SPECIAL MODES](#) (page 4-71)

(2) Touch the [Slow Scan Mode] key so that it is highlighted.

(3) Touch the [OK] key.

3

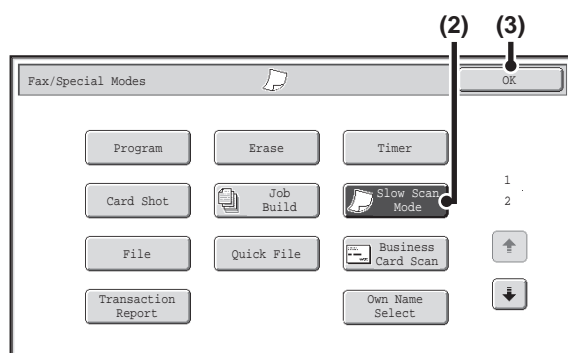

4

**Press the [START] key.**

Scanning begins. A beep will sound to indicate that scanning is finished.

**To cancel scanning...**

Press the [STOP] key (⏹).



When this function is selected, automatic 2-sided scanning is not possible.

**To cancel slow scan mode...**

Touch the [Slow Scan Mode] key in the screen of step 3 so that it is not highlighted.

**System Settings (Administrator): Original Feeding Mode**

This is used to have scanning always take place using slow scan mode.



# CHECKING THE NUMBER OF SCANNED ORIGINAL SHEETS BEFORE TRANSMISSION (Original Count)

**MX-B402SC Only**

The number of scanned original sheets can be counted and displayed before transmission. Checking the number of scanned original sheets before transmission helps prevent transmission mistakes.

**1**

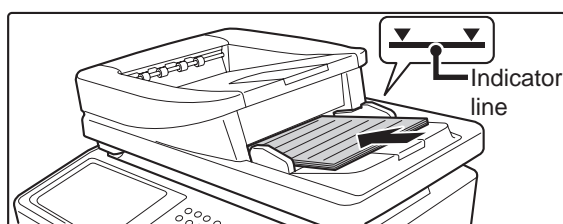

## Insert the originals face up in the document feeder tray.

Insert the originals all the way into the document feeder tray. Multiple originals can be placed in the document feeder tray. The stack of originals must not be higher than the indicator line on the tray.

**2**

## Enter the destination fax number.

[ENTERING DESTINATIONS](#) (page 4-16)

**3**

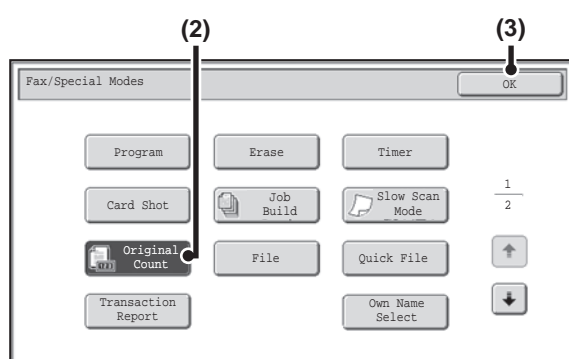

## Select the original count function.

- (1) Touch the [Special Modes] key.
  - [SPECIAL MODES](#) (page 4-71)
- (2) Touch the [Original Count] key so that it is highlighted.
- (3) Touch the [OK] key.

**4**

## Press the [BLACK & WHITE START] key.

Scanning begins.



### To cancel scanning...

Press the [STOP] key () to cancel the operation. All scanned data will be cleared.

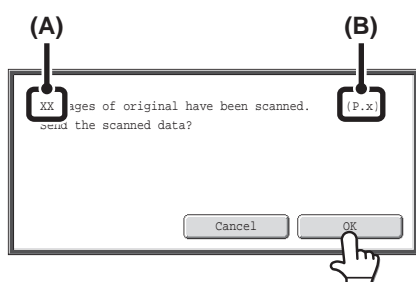

### When scanning ends, check the number of original sheets scanned and touch the [OK] key.

Transmission will begin.

- When Job Build mode is used, the confirmation message will appear after the [Read-End] key is touched.
- The message on the screen shows the number of sheets scanned in (A), and the number of pages (sheet sides) scanned in (B). For example, if both sides of one original sheet are scanned, "1" will appear in (A) and "2" will appear in (B).

- ✎ If this step is not performed for one minute while the above confirmation screen appears, the scanned image and settings will be cleared and the base screen will reappear. Scanning will not be completed automatically and the image will not be reserved for transmission.
- ↶ **If the displayed number of original sheets is different from the actual number of sheets...**  
Touch the [Cancel] key and then touch the [OK] key in the message screen to clear all scanned data. Scan settings and destination settings will not be cleared. Insert the original sheets in the automatic document feeder again and press the [BLACK & WHITE START] key to re-scan.

✎ When original count is enabled, it is enabled in other modes as well.

↶ **To cancel the Original Sheet Count function...**  
Touch the [Original Count] key in the screen of step 3 so that it is no longer highlighted.

⚙ **System Settings (Administrator): Initial Original Count Setting**  
This can be enabled to have the number of original sheets always counted. The setting can be enabled separately for each mode.

# SENDING BUSINESS CARDS (Business Card Scan)

**MX-B402 Only**

Multiple business cards can be scanned and transmitted at once.

To use this function, the business card feeder must be attached to the automatic document feeder and "Business Card Scan" must be enabled in the system settings (administrator). For the attachment procedure, see "[BUSINESS CARD FEEDER](#)" in "BEFORE USING THE MACHINE" (page 1-47).



Depending on the card type, some cards cannot be used with the automatic document feeder.

**1**

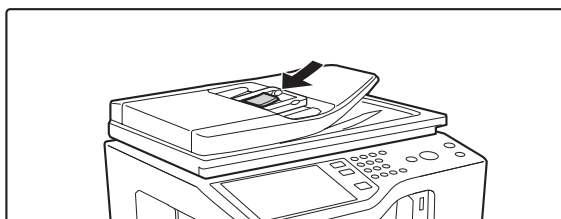

**Load the business cards.**

**2**

**Enter the destination fax number.**

[ENTERING DESTINATIONS](#) (page 4-16)

**3**

**Select the special modes.**

(1) Touch the [Special Modes] key.

(2) Touch the [Business Card Scan] key.

Read the message that appears and then touch the [OK] key.

[SPECIAL MODES](#) (page 4-71)

**4**

**Press the [START] key.**

Scanning begins. A beep will sound to indicate that scanning is finished.



**To cancel scanning...**

Press the [STOP] key ().



This function cannot be used when the scan size is specified by numerical values.



**System Settings (Administrator): Business Card Scan Option**

Specify whether or not the Business Card Scan function is used.

# CHANGING THE PRINT SETTINGS FOR THE TRANSACTION REPORT (Transaction Report)

A transaction report is automatically printed out to alert you when a transmission fails or when a broadcast transmission is performed. The transaction report contains a description of the transmission (date, start time, name of other party, time required, number of pages, result, etc.).

☞ [INFORMATION APPEARING IN THE RESULT COLUMN](#) (page 4-129)

Transaction reports are printed based on conditions set in the system settings; however, you can temporarily select different conditions for a transmission. To change the transaction report print conditions at the time of transmission, follow the steps below.

## 1 Place the original.

- 1 Place the original face up in the document feeder tray, or face down on the document glass.  
When the original is a different size than the size setting, set the original size.  
☞ [SPECIFYING THE SCAN SIZE AND SEND SIZE](#) (page 4-47)

## 2 Enter the destination fax number.

- 2 ☞ [ENTERING DESTINATIONS](#) (page 4-16)

## 3 Select the special modes.

- 3
  - (1) Touch the [Special Modes] key.
  - (2) Touch the [Transaction Report] key.
 ☞ [SPECIAL MODES](#) (page 4-71)

## 4 Select print conditions.

- (1) Select the print conditions.
- (2) Touch the [OK] key.

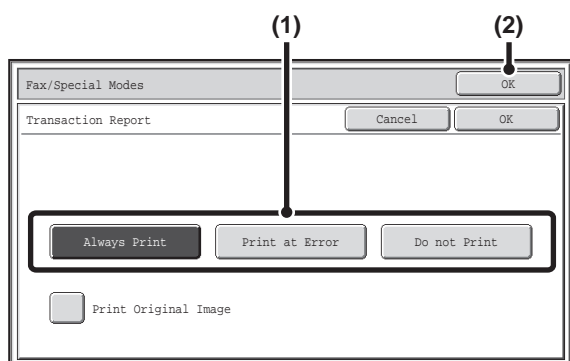

4



- The print conditions for a transaction report are as follows:
  - "Always Print": A transaction report is printed no matter whether the transmission succeeds or fails.
  - "Print at Error": A transaction report is printed when transmission fails.
  - "Do not Print": Do not print a transaction report.
- When the [Print Original Image] checkbox is selected , part of the transmitted original is included on the transaction report.
- Even if the [Print Original Image] checkbox is selected , the original cannot be printed when speaker dialing, direct transmission, polling reception, or F-code transmission is used.

5

**Press the [START] key.**

Scanning begins.

- If you inserted the original pages in the document feeder tray, all pages are scanned.  
A beep will sound to indicate that scanning is finished.
- If you are scanning the original on the document glass, scan each page one page at a time.  
When scanning finishes, place the next original and press the [START] key. Repeat until all pages have been scanned and then touch the [Read-End] key.  
A beep will sound to indicate that scanning is finished.

**To cancel scanning...**Press the [STOP] key () to cancel the operation.

For a broadcast transmission, changes to the transaction report print conditions apply to all destinations.

**To cancel the transaction report setting...**

Touch the [Cancel] key in the screen of step 4.

**• System Settings (Administrator): Transaction Report Print Select Setting**

This is used to set the conditions for printing transaction reports.

The factory default setting is .Single Sending: Print Out All Report//No Printed ReportBroadcasting: /Print Out Error Report Only/No Printed ReportReceiving: Print Out All Report/Print Out Error Report Only/Confidential Reception (fax mode): /No Printed Report**• System Settings (Administrator): Original Print on Transaction Report**

This is used to have part of the transmitted original printed on the transaction report.

# ADDING YOUR SENDER INFORMATION TO FAXES (Own number sending)

Your sender information (date, time, sender name, sender fax number, number of pages) is automatically added to the top of each fax page you transmit.

## Example of the sender information printed

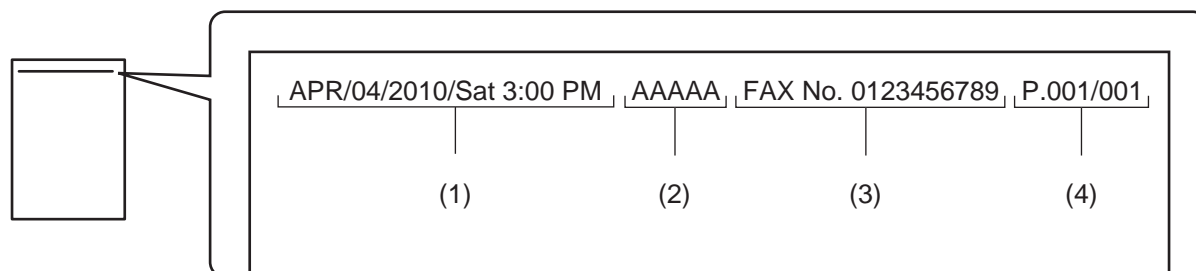

- (1) Date, time: The date and time of transmission.
- (2) Sender name: The sender name programmed in the machine.
- (3) Sender fax number: The sender fax number programmed in the machine.
- (4) Page numbers: Page number / total pages (the total page number is only printed when the fax is sent by memory transmission.)



### Information programmed in Own Number Sending

- Date, time: Adjust the setting in "Clock Adjust" in the system settings.
- Sender name, sender fax number: Program the sender name and fax number in "Sender Data Registration" in the system settings (administrator). If you intend to use own number sending, be sure to configure this information.
- Page numbers: Select whether or not to include page numbers in "Printing Page Number at Receiver" in the system settings (administrator).  
Page numbers appear in the format "page number / total pages". Only the page number is printed when manual transmission or quick online transmission is used.



### System Settings (Administrator): Date/Own Number Print Position Setting

This is used to set the position where the sender information is printed. The sender information can be printed outside the scanned original image or inside the scanned original image.

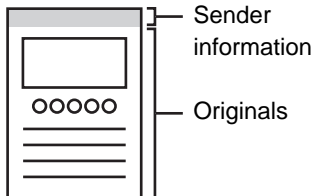
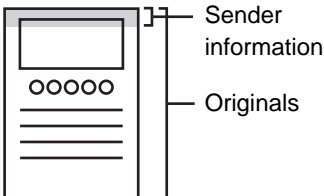
Outside scanned image (factory default setting)	Inside scanned image
 <p>The transmitted image length will be: length of sender information + length of original image. When the fax is printed by the receiving machine, it may be reduced or divided onto two pages.</p>	 <p>The sender information is printed inside the original image, and thus the transmitted image length is the length of the original. Note that the sender information will overlap part of the original image (the overlapped part of the original image will not appear).</p>

# TEMPORARILY CHANGING THE SENDER INFORMATION (Own Name Select)

You can select the sender information printed on a transmitted fax from a list of stored senders.

## Select the special modes.

1

- (1) Touch the [Special Modes] key.
- (2) Touch the [Own Name Select] key.

 [SPECIAL MODES](#) (page 4-71)

2

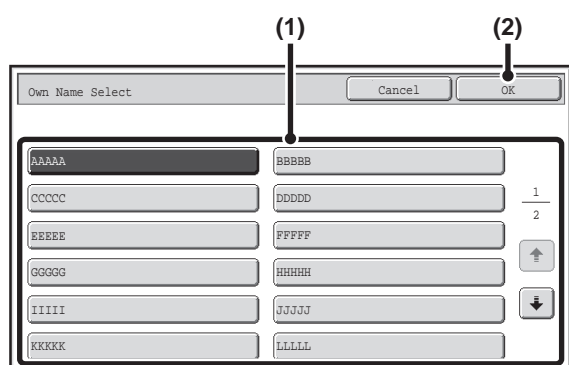

## Select the sender information.

- (1) Touch the desired sender information key.
- (2) Touch the [OK] key.

3

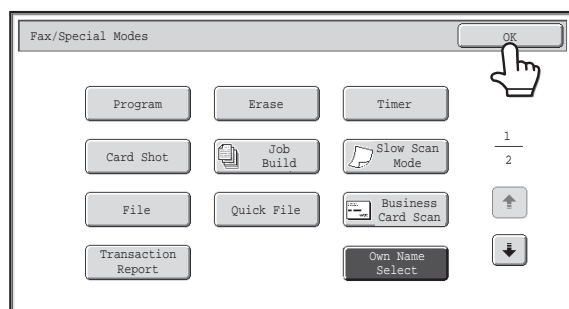

## Touch the [OK] key.



### System Settings (Administrator): Registration of Own Name Select

This is used to store sender information for Own Name Select.

# CALLING A FAX MACHINE AND INITIATING RECEPTION (Polling)

The Polling function allows the receiving machine to call the transmitting machine and initiate reception of a document in that machine.

Because the receiving machine initiates reception of a document, this is called "Polling Reception".

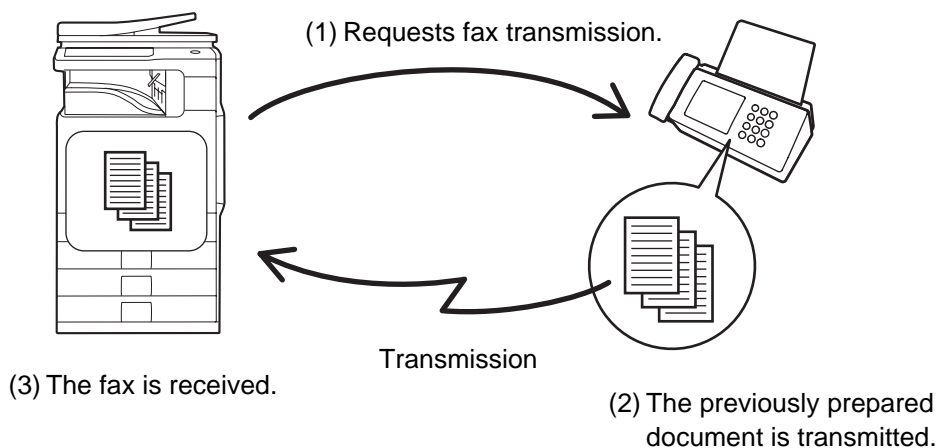

Make sure that an original is not placed in the machine when using the polling reception function.

1

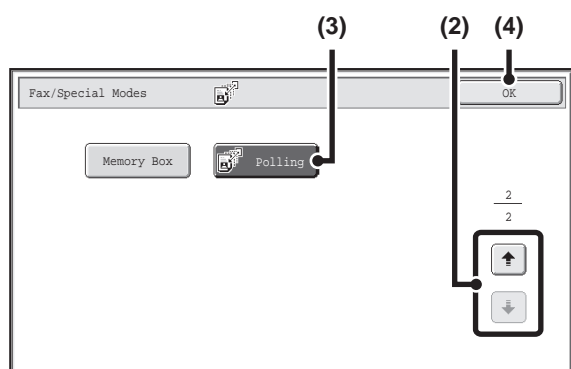

## Select polling reception.

- (1) Touch the [Special Modes] key.  
[SPECIAL MODES](#) (page 4-71)
- (2) Touch the keys to switch through the screens.
- (3) Touch the [Polling] key so that it is highlighted.
- (4) Touch the [OK] key.

2



## Enter the destination fax number.

[ENTERING DESTINATIONS](#) (page 4-16)

- **Multiple fax numbers can be entered.**  
 Polling will take place in the order that the numbers were entered.  
 Polling multiple machines is called "Serial Polling".  
 Up to 500 fax numbers can be entered. In this procedure, one-touch keys that have a sub-address and passcode cannot be used.
- To enter multiple fax numbers, touch the [Next Address] key after entering a fax number and enter the next fax number.



**3****Press the [START] key.**

Your machine will call the other machine and initiate reception of the fax.



- Polling reception can be used in combination with the timer function to poll at any specified time, such as at night or when you are not present (Only one timer polling reception can be set.).
- This function can only be used when the other machine is Super G3 or G3 compatible and has a polling function.
- The receiving machine bears the expense (phone charges) of the polling reception.

**To cancel polling reception...**

Touch the [Polling] key in the screen of step 1 so that it is not highlighted.

# INITIATING POLLING RECEPTION MANUALLY

Use this procedure when you must start polling after listening to a recorded greeting, such as when using a fax information service.



- Make sure that an original is not placed in the machine when using the polling reception function.
- This function cannot be used to poll multiple machines (serial polling).

1

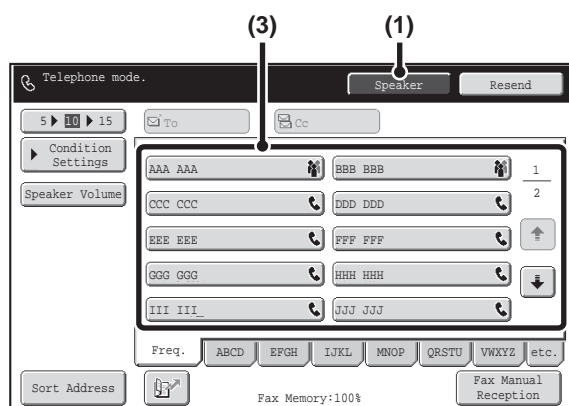

## Enter the destination fax number.

- Touch the [Speaker] key.**  
You will hear the dial tone through the machine's speaker.
- Touch the [Address Book] key in the base screen.**  
For the [Address Book] key, see "[BASE SCREEN OF FAX MODE](#)" (page 4-8).
- Touch the one-touch key of the desired destination.**  
A group key cannot be used.



- In addition to specification by one-touch key, a destination can also be specified using a search number. You can also directly enter a fax number with the numeric keys or look up a destination in a global address book. For more information, see "[ENTERING DESTINATIONS](#)" (page 4-16).
- After touching the [Speaker] key, you can touch the [Speaker Volume] key to adjust the volume of the speaker. The speaker volume changes each time the [Speaker Volume] key is touched. Adjust the volume to the desired level.

2

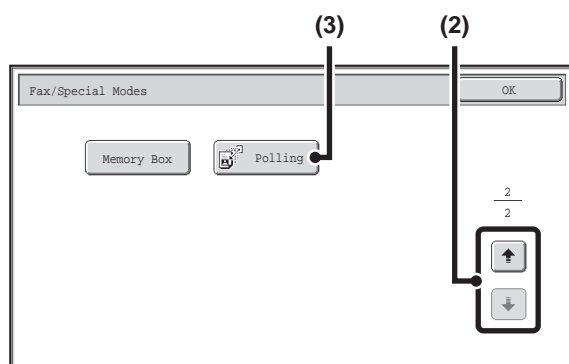

## Receive the fax.

- Touch the [Special Modes] key.**  
 [SPECIAL MODES](#) (page 4-71)
- Touch the keys to switch through the screens.**
- When you hear the fax tone, touch the [Polling] key.**  
The fax is received.



- This function can only be used when the other machine is Super G3 or G3 compatible and has a polling function.
- The receiving machine bears the expense (phone charges) of the polling reception.

# SENDING A FAX WHEN ANOTHER MACHINE POLLS YOUR MACHINE (Polling Memory)

Sending a document that has been scanned into memory when another machine polls your machine is called "Polling Memory".

Prior to polling, the document that will be faxed to the other machine must be scanned into a polling memory box. This function can only be used when the other machine is Super G3 or G3 compatible and has a polling function.

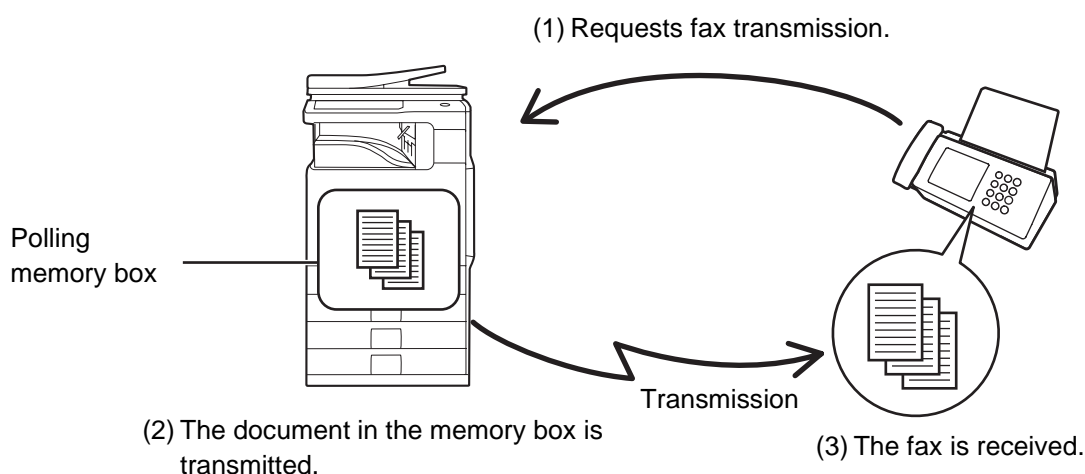

## RESTRICTING POLLING ACCESS (Polling security)

To only allow specified machines to poll your machine, you can restrict polling to machines whose programmed sender fax number matches a fax number stored in your machine as a polling passcode number. This is called "Polling Security".

To use this function, first store polling passcode numbers (the sender fax numbers programmed in the other machines) in the machine's system settings, and then enable polling security.

 Up to 10 fax numbers can be stored as polling passcode numbers.

 **System Settings (Administrator): Fax Polling Security**  
This is used to enable polling security. This is used to store fax numbers as polling passcode numbers.



# SCANNING A DOCUMENT INTO POLLING MEMORY

Follow these steps to scan a document into the memory box for polling transmission (Public Box).

## 1 Place the original.

- 1** Place the original face up in the document feeder tray, or face down on the document glass.  
When the original is a different size than the size setting, set the original size.  
☞ [SPECIFYING THE SCAN SIZE AND SEND SIZE](#) (page 4-47)

## 2 Select the special modes.

- 2**
- (1) Touch the [Special Modes] key.
- (2) Touch the   keys to switch through the screens.
- (3) Touch the [Memory Box] key.  
☞ [SPECIAL MODES](#) (page 4-71)

**3**

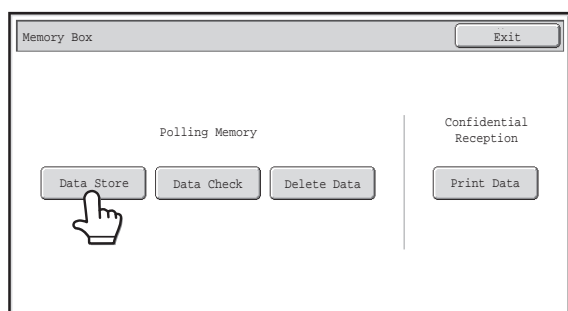

Touch the [Data Store] key.

**4**

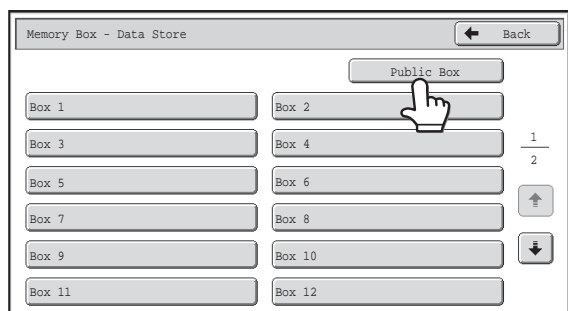

Touch the [Public Box] key.

**5**

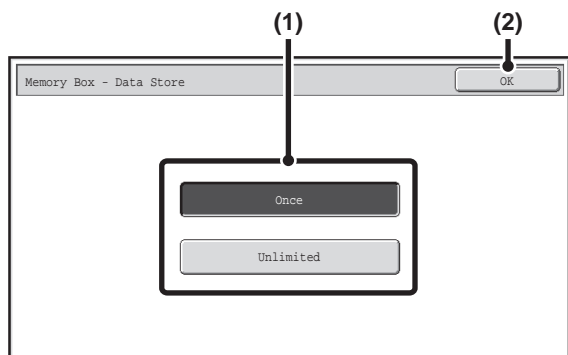

Specify the number of polling times.

- (1) Touch the key for the desired number of times.

Touch the [Once] key if you want the document cleared from memory after it is transmitted. Touch the [Unlimited] key to allow polling an unlimited number of times.

- (2) Touch the [OK] key.

6

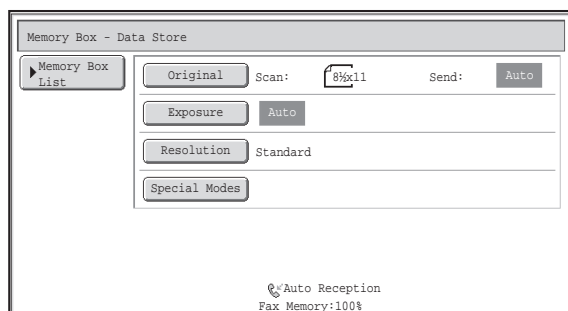

Select image settings and special modes.



- A program, timer setting, transaction report, polling and document filing cannot be selected.
- To return to the screen of step 4, touch the [Memory Box List] key.

7

### Press the [START] key.

Scanning begins.

- If you inserted the original pages in the document feeder tray, all pages are scanned.
  - If you are scanning the original on the document glass, scan each page one page at a time.
- When scanning finishes, place the next original and press the [START] key. Repeat until all pages have been scanned and then touch the [Read-End] key.



#### To cancel scanning...

Press the [STOP] key (⏹) while the original is being scanned.





If another document remains in the memory box (Public Box), the newly scanned document is added to the previous document. In this case, the number of polling times will be the number set for the newly scanned document.

# CHECKING THE DOCUMENT IN THE PUBLIC BOX

You can check the document stored in the machine's public box for memory polling.

## Select the special modes.

1

- (1) Touch the [Special Modes] key.
  - (2) Touch the   keys to switch through the screens.
  - (3) Touch the [Memory Box] key.
-  [SPECIAL MODES](#) (page 4-71)

2

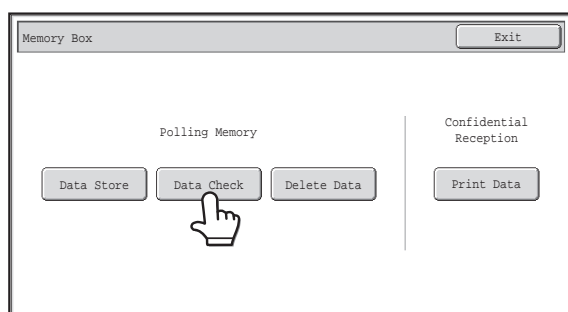

Touch the [Data Check] key.

3

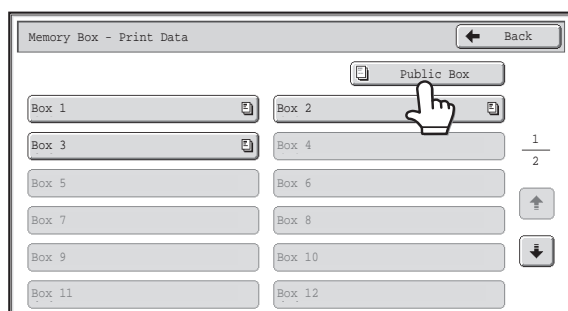

Touch the [Public Box] key.



When nothing is stored in the Public Box, the [Public Box] key will be grayed out.

4

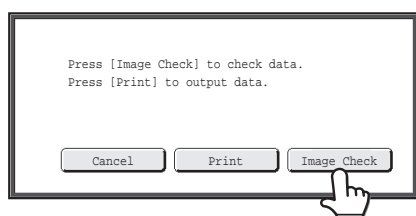

Touch the [Image Check] key.



The content of the document can be viewed in the image check screen. For information on the image check screen, see "[IMAGE CHECK SCREEN](#)" (page 4-65). To print the document, touch the [Print] key.

# DELETING A DOCUMENT FROM THE PUBLIC BOX

Delete a document from the Public Box when it is no longer needed.

## Select the special modes.

1

- (1) Touch the [Special Modes] key.
  - (2) Touch the   keys to switch through the screens.
  - (3) Touch the [Memory Box] key.
-  [SPECIAL MODES](#) (page 4-71)

2

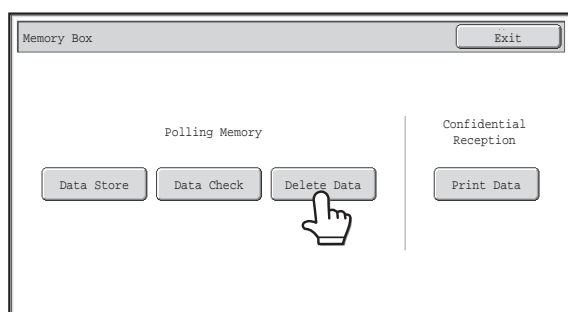

Touch the [Delete Data] key.

3

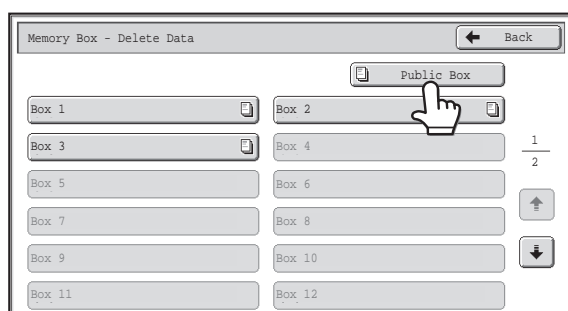

Touch the [Public Box] key.



When nothing is stored in the Public Box, the [Public Box] key will be grayed out.

4

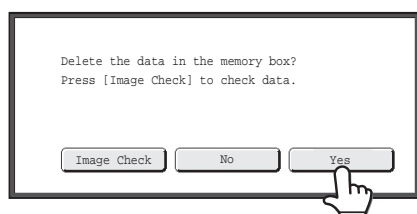

Touch the [Yes] key.

- The document is deleted and you return to the screen of step 3.
- You can touch the [Image Check] key to check the image in the touch panel before deleting it. For information on the image check screen, see "[IMAGE CHECK SCREEN](#)" (page 4-65).



### To cancel the deletion...

Touch the [No] key. You will return to the screen of step 3.

# PERFORMING F-CODE COMMUNICATION

This section explains how to perform F-code communication operations. F-code communication is possible with machines of other manufacturers that also support F-code communication.

## F-CODE COMMUNICATION

Exchange of confidential documents (confidential communication), retrieval (polling) and distribution (polling memory) of information, and distribution of information to multiple destinations (relay broadcast transmission) are possible with other machines that support F-code communication.

A F-code\* is specified in each communication, enabling a higher level of security.

\* F-code is a communication function based on the G3 standard of the ITU-T.

 The ITU-T is a United Nations organization that establishes communications standards. It is a department of the International Telecommunication Union (ITU), which coordinates global telecommunications networks and services.

## HOW F-CODES WORK

A fax that is transmitted with a F-code is received to the memory box in the receiving machine specified by the F-code (sub-address and passcode). If the F-code sent by the transmitting machine does not match the F-code in the receiving machine, reception will not take place.

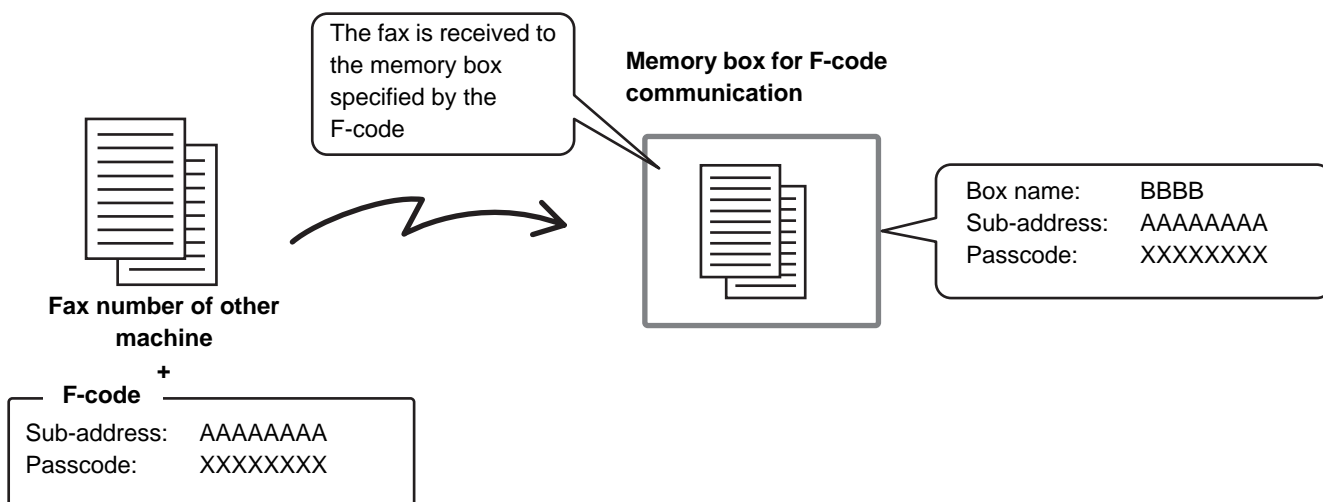

The products of other manufacturers may use different terms for "sub-address" and "passcode". If you need to contact the operator of another machine regarding sub-addresses and passcodes, refer to the terms used by the ITU-T in the table below.

The machine	ITU-T		
	F-code polling memory box	F-code confidential box	F-code relay broadcast memory box
Sub Address	SEP	SUB	SUB
Passcode	PWD	SID	SID

 A F-code consists of a sub-address and passcode, and cannot be longer than 20 digits.



# CREATING MEMORY BOXES IN THE MACHINE FOR F-CODE COMMUNICATION

Before the F-code communication function can be used, special memory boxes must be created using "F-Code Memory Box" in the system settings.

A box name and F-code (sub-address and passcode) are programmed in each box, and a F-code communication function is assigned to each box.

After you have created a memory box, inform the other party of the sub-address and passcode of the box.

## Memory box for F-code communication

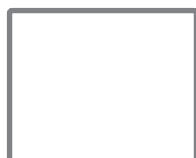

- Box Name
- Sub Address
- Passcode
- End receiving machines (only in a F-code relay broadcast memory box)
- Print PIN (only for F-code confidential reception)

To use the following F-code communication functions, F-code memory boxes must be created in your machine:

F-code confidential reception, F-code polling memory, F-code relay broadcast transmission

To use the following F-code communication functions, F-code memory boxes must be created in the other machine:

F-code confidential transmission, F-code polling reception, F-code relay request transmission



### System Settings: [F-Code Memory Box](#) (page 7-104)

This is used to configure memory boxes for F-code communication.

- Up to 100 memory boxes can be created.
- The memory box name cannot be longer than 18 characters, and the sub-address and passcode cannot be longer than 20 digits.

## F-CODE DIALING

When performing a F-code operation, the F-code (sub-address and passcode) is appended to the fax number that is dialed. Check the F-code (sub-address and passcode) programmed in the memory box in the other machine before you perform a F-code transmission. It is convenient to store a F-code together with the fax number in a one-touch key or group key.

0123456789 / AAAAAAAAA / XXXXXXXX  
 Fax number of other machine \* Sub Address \* Passcode

\* Touch the [Sub Address] key in the screen to enter "/".

When the following F-code functions are used, your machine dials the other machine:

F-code confidential transmission, F-code polling reception, F-code relay request transmission

When the following F-code functions are used, the other machine dials your machine:

F-code confidential reception, F-code polling memory, F-code relay broadcast transmission



- If the destination machine does not have a passcode configured in the F-code, do not enter a passcode when dialing that machine.
- F-code communication cannot be performed when using the speaker or performing manual transmission.



### System Settings: [Address Book](#) (page 7-17)

This is used to store and edit one-touch keys and group keys.

# CONFIDENTIAL COMMUNICATION USING F-CODES

By sending a fax to a F-code memory box (confidential) in the receiving machine (your machine or the other machine), the sender can direct the transmission specifically to the user of the box.

This is convenient for sending sensitive documents that you do not wish people other than the recipient to see, or when the receiving machine is shared by multiple departments.

To print a F-code confidential fax, the print passcode must be entered.

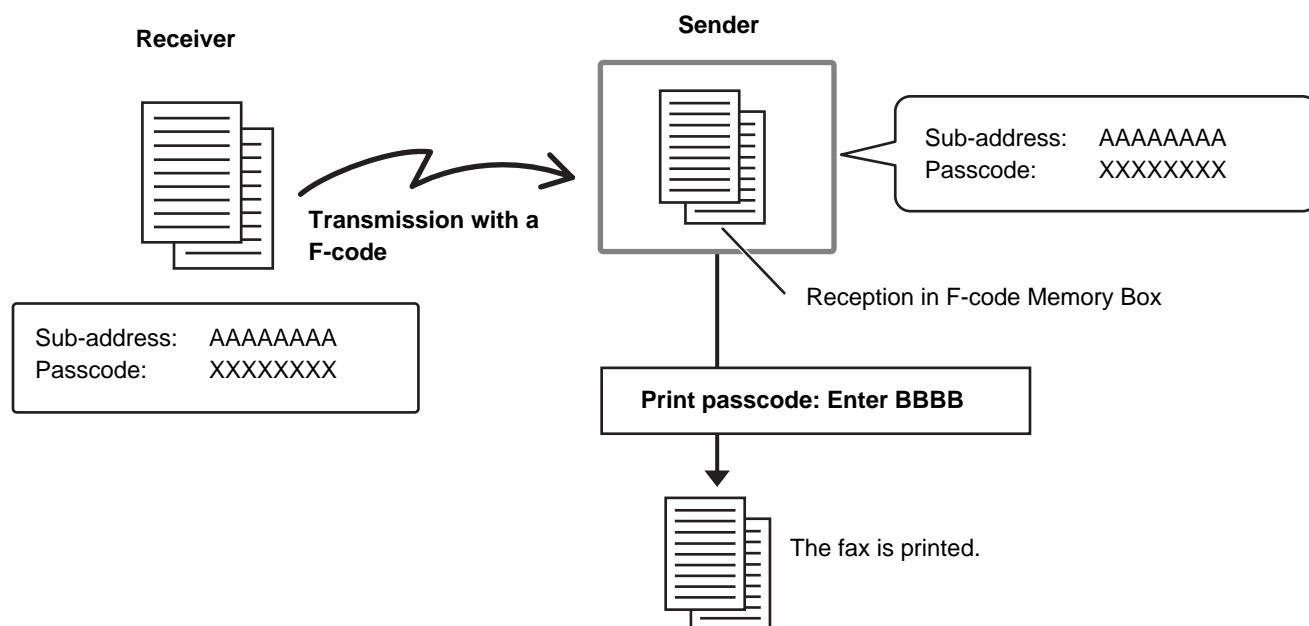

 The F-code (sub-address and passcode) of the memory box to be used should be verified by the sender and the recipient before the fax is sent.

 **System Settings: F-Code Memory Box (page 7-104)**  
This is used to create memory boxes for F-code confidential communication (confidential reception). A memory box name, sub-address, passcode, and print passcode are programmed in each box.

# F-CODE CONFIDENTIAL TRANSMISSION

Follow the steps below to send a confidential fax by adding a F-code to the fax number.

## 1

### Place the original.

Place the original face up in the document feeder tray, or face down on the document glass.

When the original is a different size than the size setting, set the original size.

☞ [SPECIFYING THE SCAN SIZE AND SEND SIZE](#) (page 4-47)

## 2

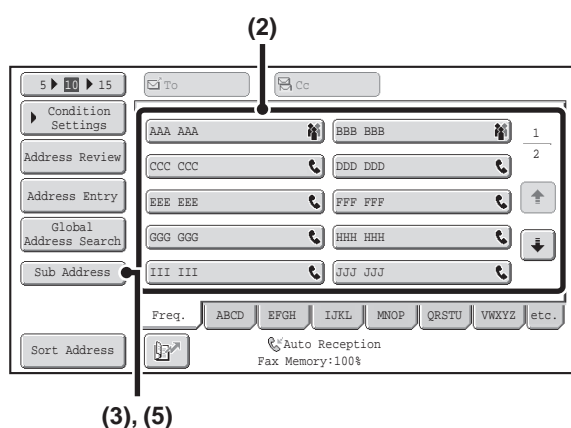

### Enter the destination fax number.

(1) Touch the [Address Book] key in the base screen.

For the [Address Book] key, see "[BASE SCREEN OF FAX MODE](#)" (page 4-8).

(2) Touch the one-touch key of the desired destination.

If the destination is not stored in the address book, enter the fax number with the numeric keys.

If the sub-address and passcode are stored in the one-touch key, the following sub-steps are not necessary. Go to step 3.

(3) Touch the [Sub Address] key.

"/" appears.

(4) Enter the sub-address with the numeric keys.

(5) Touch the [Sub Address] key.

"/" appears.

(6) Enter the passcode with the numeric keys.



If a passcode has been omitted in the memory box of the other machine, (5) and (6) are not necessary.

## 3

### Press the [START] key.

Scanning begins.

- If you inserted the original pages in the document feeder tray, all pages are scanned.

A beep will sound to indicate that scanning is finished.

- If you are scanning the original on the document glass, scan each page one page at a time.

When scanning finishes, place the next original and press the [START] key. Repeat until all pages have been scanned and then touch the [Read-End] key.

A beep will sound to indicate that scanning is finished.



This function can be used in combination with a broadcast transmission or timer transmission. This function can also be stored in a program.

# CHECKING FAXES RECEIVED BY F-CODE CONFIDENTIAL RECEPTION

When a F-code confidential fax is sent to your machine, the fax is received to the memory box specified by the F-code. To check received faxes, enter the print passcode.

1

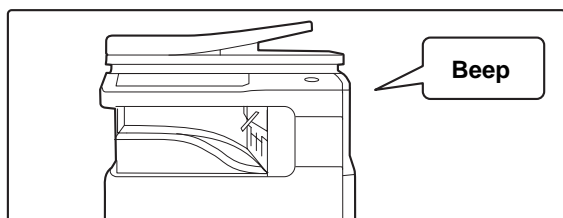

**The machine rings and the fax is received.**

A beep sounds when reception ends.

2

**Select the special modes.**

(1) Touch the [Special Modes] key.

(2) Touch the   keys to switch through the screens.

(3) Touch the [Memory Box] key.

 [SPECIAL MODES](#) (page 4-71)

3

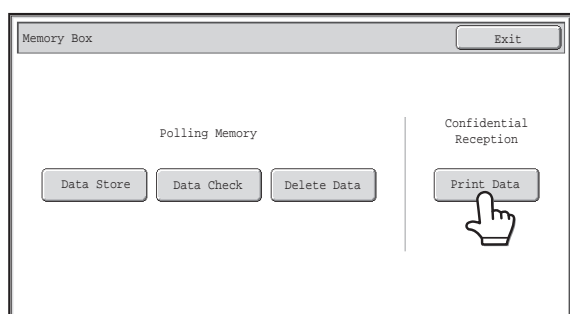

**Touch the [Print Data] key.**

4

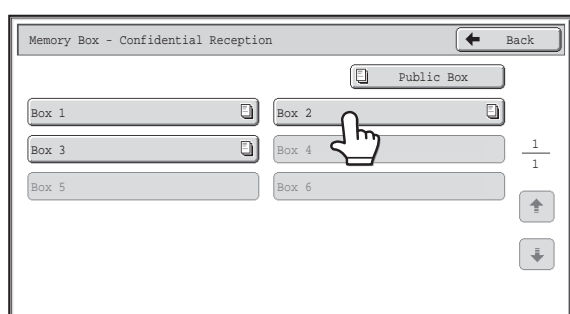

**Touch the key of the memory box containing the confidential fax.**

"" appears in the keys of memory boxes that have received faxes. The keys of memory boxes that have not received faxes are grayed out and cannot be selected.

5

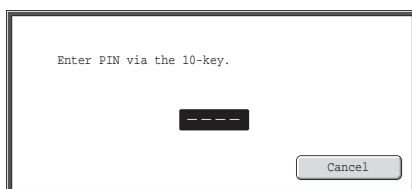

## Enter the print passcode with the numeric keys.

As each digit is entered, "-" changes to "\*".



Take care to enter the correct print passcode. If you make a mistake, a message will appear and you will return to the entry screen. You can touch the [Cancel] key to return to step 4.

6

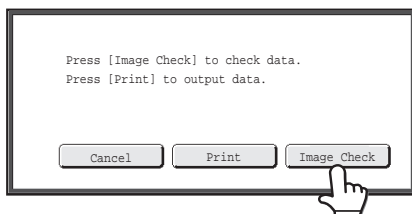

## Touch the [Image Check] key.

The content of the document can be viewed in the image check screen. For information on the image check screen, see "[IMAGE CHECK SCREEN](#)" (page 4-65).

To print the document, touch the [Print] key.



- The confidential fax is automatically given priority in the print job queue.
- The fax is automatically cleared from the memory box after printing.

### • If you forget the print passcode...

There is no way to check a forgotten passcode on the machine. Take care not to forget the passcode. In the event that you forget the passcode or need to verify the passcode, contact your dealer or nearest SHARP Service Department.



### System Settings (Administrator): Transaction Report Print Select Setting

This setting can be used to have a transaction report printed automatically when a F-code confidential fax is received.

# POLLING RECEPTION USING F-CODES

This function enables your machine to call another machine and initiate reception of a fax stored in a F-code memory box (polling memory) in the other machine. During the polling operation, your machine must correctly specify the F-code (sub-address and passcode) configured in the other machine or polling reception will not take place.

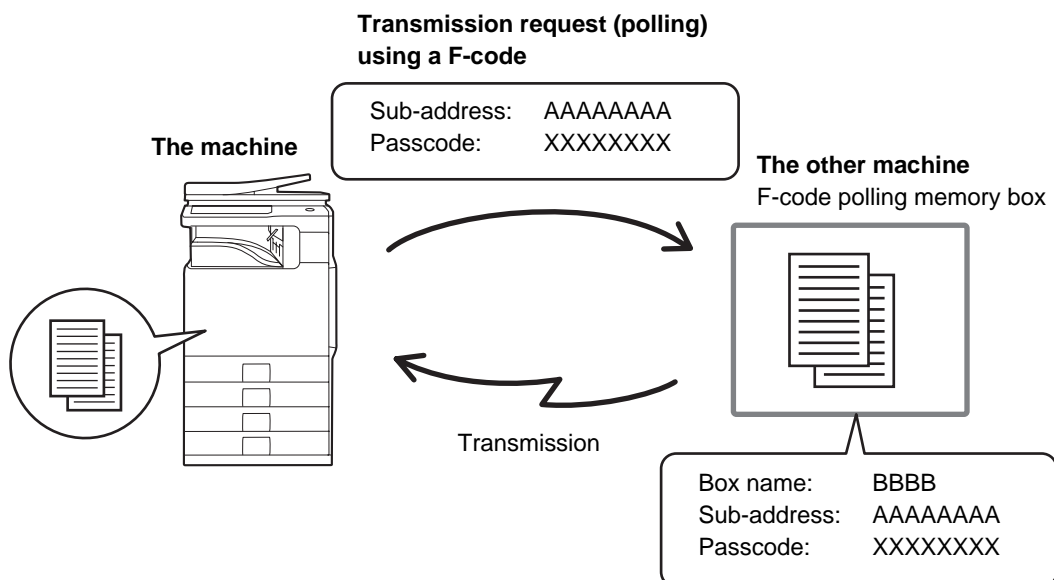

- Verify the F-code (sub-address and passcode) of the memory box in the other machine before you perform F-code polling reception.
- Do not place an original in the automatic document feeder or on the document glass when using this function.
- The receiving machine bears the phone charges of the transmission.

1

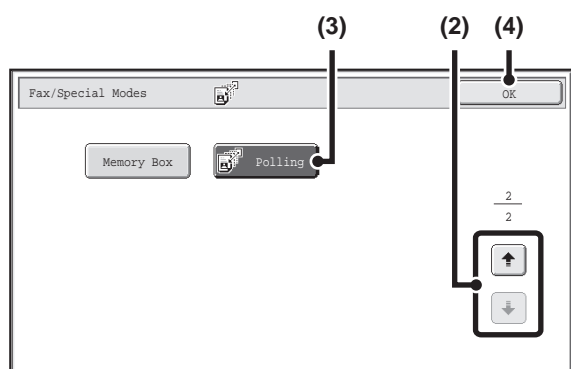

## Select polling.

- (1) Touch the [Special Modes] key.  
 ➔ [SPECIAL MODES](#) (page 4-71)
- (2) Touch the keys to switch through the screens.
- (3) Touch the [Polling] key so that it is highlighted.
- (4) Touch the [OK] key.

## 2

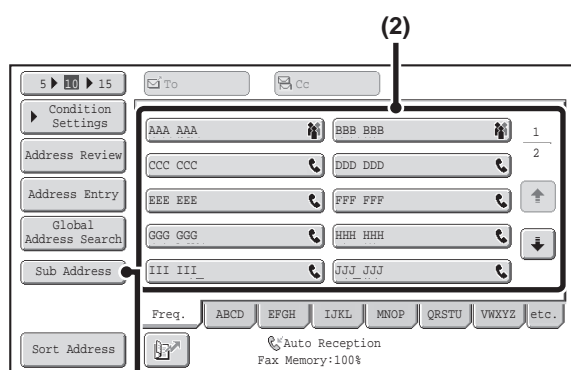

(3), (5)

**Enter the destination fax number.**

- (1) Touch the [Address Book] key in the base screen.**

For the [Address Book] key, see "BASE SCREEN OF FAX MODE" (page 4-8).

- (2) Touch the one-touch key of the desired destination.**

If the destination is not stored in the address book, enter the fax number with the numeric keys.

If the sub-address and passcode are stored in the one-touch key, the following sub-steps are not necessary. Go to step 3.

- (3) Touch the [Sub Address] key.**

"/" appears.

- (4) Enter the sub-address with the numeric keys.**

- (5) Touch the [Sub Address] key.**

"/" appears.

- (6) Enter the passcode with the numeric keys.**



If a passcode has been omitted in the memory box of the other machine, (5) and (6) are not necessary.

## 3

**Press the [START] key.**

Your machine will call the other machine and initiate reception of the fax.



- Polling multiple machines (serial polling) is not possible.
- F-code polling reception can be used in combination with a timer setting. Only one polling reception operation with a timer setting can be stored at a time.  
[SENDING A FAX AT A SPECIFIED TIME \(Timer\)](#) (page 4-77)

**To cancel polling...**

Touch the [Polling] key in the screen of step 1 so that it is not highlighted.

# POLLING MEMORY TRANSMISSION USING F-CODES

When your machine receives a transmission request from another machine, this function sends a fax stored in a F-code memory box (polling memory) in your machine to that machine. The other machine must correctly specify the F-code configured in your machine or transmission will not take place.

The document to be transmitted must be scanned into a F-code polling memory box.

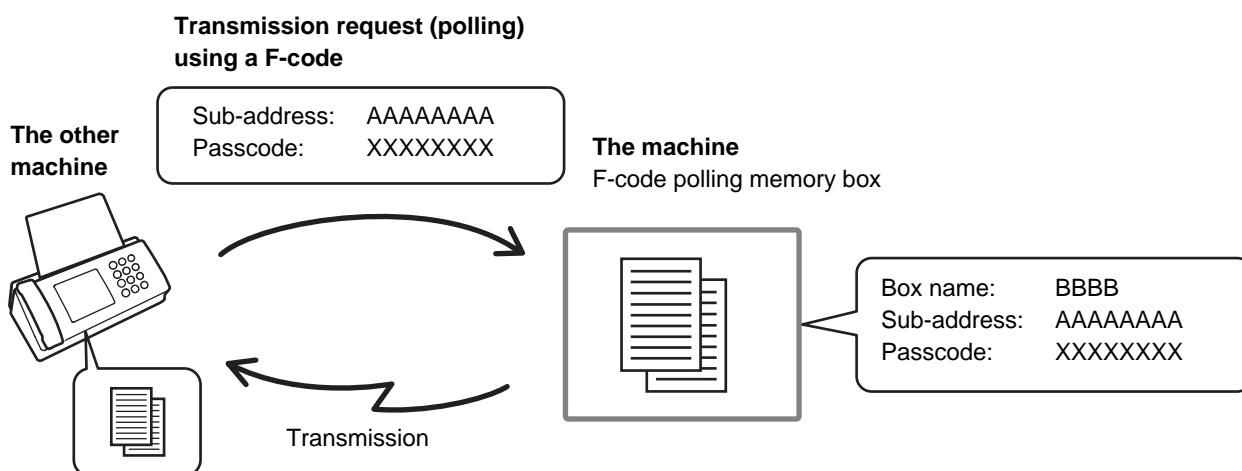

## System Settings: F-Code Memory Box (page 7-104)

This is used to create memory boxes (polling memory) for F-code polling memory transmission. A memory box name, sub-address, and passcode are programmed in each box.

## SCANNING A DOCUMENT INTO A MEMORY BOX FOR F-CODE POLLING TRANSMISSION

Follow these steps to scan a document into a memory box (polling memory) for F-code polling transmission.

### 1

### Place the original.

Place the original face up in the document feeder tray, or face down on the document glass.

When the original is a different size than the size setting, set the original size.

[SPECIFYING THE SCAN SIZE AND SEND SIZE](#) (page 4-47)

### 2

### Select the special modes.

(1) Touch the [Special Modes] key.

(2) Touch the keys to switch through the screens.

(3) Touch the [Memory Box] key.

[SPECIAL MODES](#) (page 4-71)



3

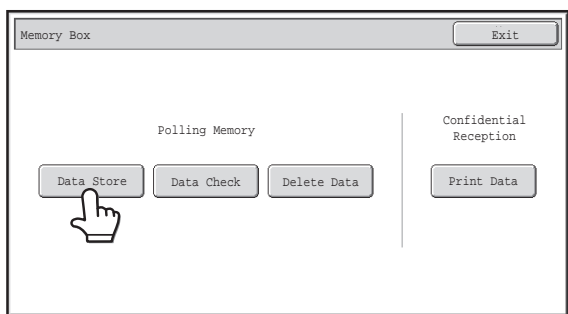

Touch the [Data Store] key.

4

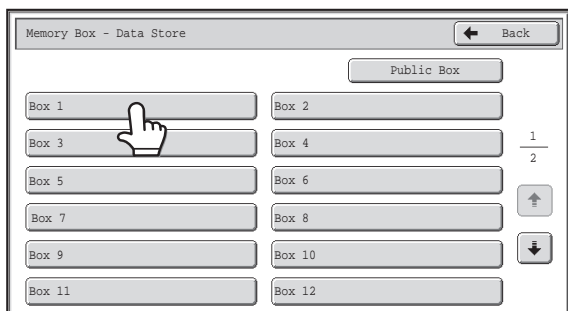

Touch the key of the F-code memory polling box.

5

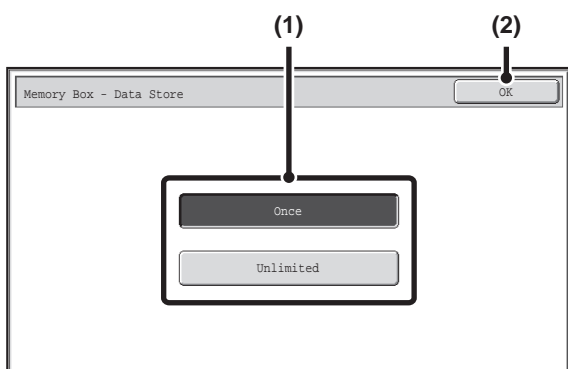

Specify the number of polling times.

(1) Touch the key for the desired number of times.

Touch the [Once] key if you want the document cleared from memory after it is transmitted. Touch the [Unlimited] key to allow polling an unlimited number of times.

(2) Touch the [OK] key.

6

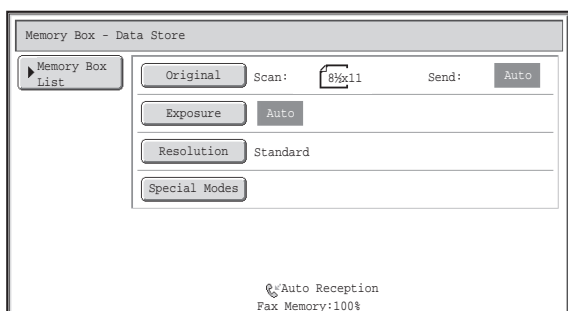

Select image settings and special modes.



- A program, timer setting, transaction report, polling and document filing cannot be selected.
- To return to the screen of step 4, touch the [Memory Box List] key.

## 7

**Press the [START] key.**

Scanning begins.

- If you inserted the original pages in the document feeder tray, all pages are scanned.
- If you are scanning the original on the document glass, scan each page one page at a time.

When scanning finishes, place the next original and press the [START] key. Repeat until all pages have been scanned and then touch the [Read-End] key.

---

**To cancel scanning...**

Press the [STOP] key (⏹) while the original is being scanned.



- If other documents have already been stored in the memory box, the document is added to the previously stored documents.
- The factory default setting for the number of polling times is "Once" (after the document is transmitted to the receiving machine, it is automatically cleared).

# CHECKING THE DOCUMENT IN THE F-CODE MEMORY POLLING BOX



You can check the document stored in the F-code memory polling box.



A document in a memory box cannot be printed while the document is being transmitted.

## Select the special modes.

1

- (1) Touch the [Special Modes] key.
  - (2) Touch the   keys to switch through the screens.
  - (3) Touch the [Memory Box] key.
-  [SPECIAL MODES](#) (page 4-71)

2

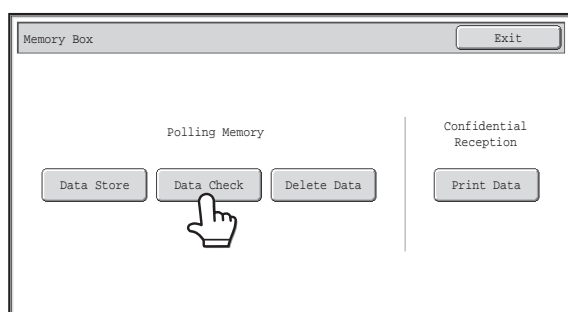

Touch the [Data Check] key.

3

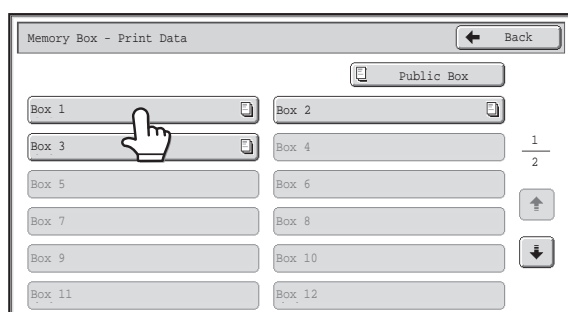

Touch the key of the F-code memory polling box where the document you wish to print is stored.

 appears in keys that have documents stored.

4

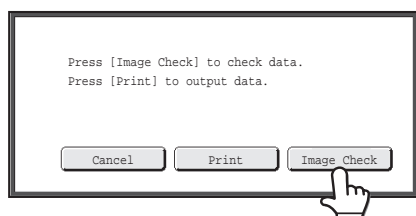

Touch the [Image Check] key.

The content of the document can be viewed in the image check screen. For information on the image check screen, see "[IMAGE CHECK SCREEN](#)" (page 4-65).

To print the document, touch the [Print] key.

# DELETING A DOCUMENT STORED FOR F-CODE POLLING TRANSMISSION



When a document in a F-code memory polling box is no longer needed, follow the steps below to delete it.



A document in a memory box cannot be deleted while the document is being transmitted.

## Select the special modes.

1

- (1) Touch the [Special Modes] key.
  - (2) Touch the   keys to switch through the screens.
  - (3) Touch the [Memory Box] key.
-  [SPECIAL MODES](#) (page 4-71)

2

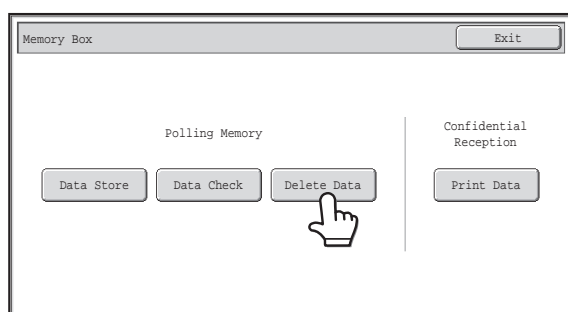

Touch the [Delete Data] key.

3

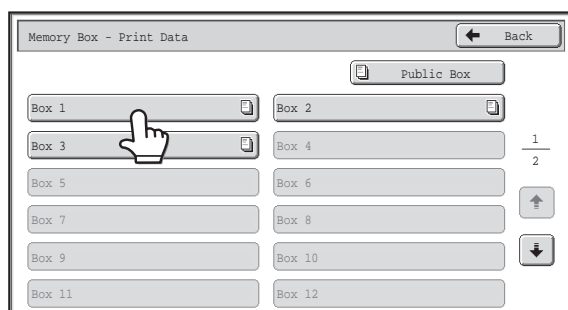

Touch the key of the F-code memory polling box that has the document you wish to delete.

 appears in keys that have documents stored.

4

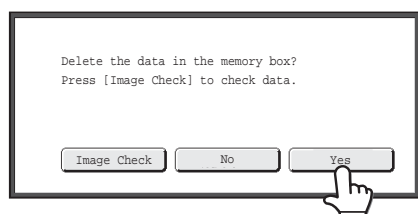

Touch the [Yes] key.

- The document is deleted and you return to the screen of step 3.
- You can touch the [Image Check] key to check the image in the touch panel before deleting it. For information on the image check screen, see "[IMAGE CHECK SCREEN](#)" (page 4-65).



### To cancel the deletion...

Touch the [No] key. You will return to the screen of step 3 without deleting the document.

# RELAY REQUEST TRANSMISSION USING F-CODES

This function is used to send a fax to a F-code relay broadcast memory box in another machine and have that machine relay the fax to multiple end receiving machines.

When the end receiving machines are far from your machine, sending the fax to a relay machine that is close to the end receiving machines can help reduce phone charges. A relay request transmission can be used in combination with the timer transmission function to further reduce phone costs.

🔊 [SENDING A FAX AT A SPECIFIED TIME \(Timer\)](#) (page 4-77)

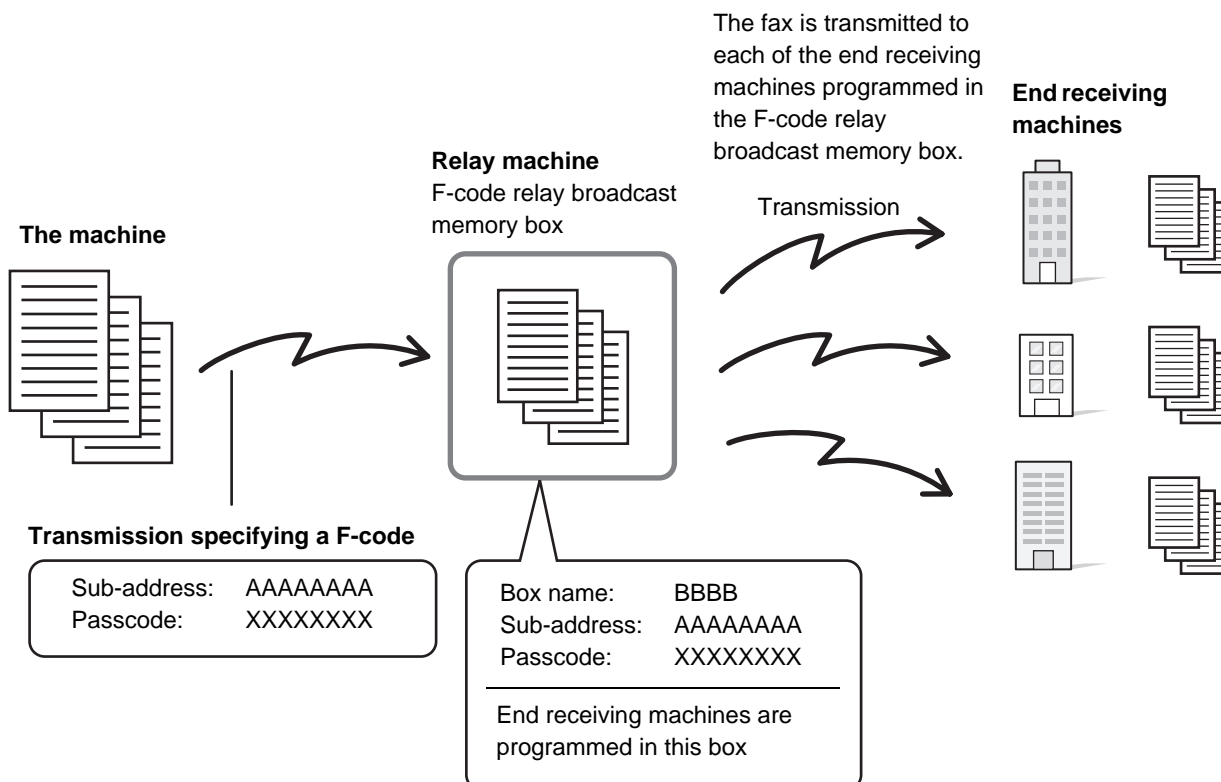

- Verify the F-code (sub-address and passcode) and end receiving machines programmed in the relay broadcast memory box in the relay machine before you perform a F-code relay request transmission.
- Before this function can be used, the end receiving machines must be programmed in the F-code relay broadcast memory box in the relay machine.
- The end receiving machines do not need to support F-code communication.
- This function can be used in combination with a broadcast transmission or timer transmission. A F-code relay request transmission can also be stored in a program.
- Your machine (the machine that requests a relay broadcast transmission) only bears the cost of sending the fax to the relay machine. The relay machine bears the cost of sending the fax to each of the end receiving machines.
- When faxes forwarded using this function are printed at the forwarding destination, the date and time of reception cannot be printed on the faxes. ("Receiving Date & Time Print" is disabled.)



## System Settings: [F-Code Memory Box](#) (page 7-104)

This is used to create memory boxes for F-code relay broadcast transmission.

A memory box name, sub-address, passcode, and end receiving machines are programmed in each box.

## 1 Place the original.

1

Place the original face up in the document feeder tray, or face down on the document glass.

When the original is a different size than the size setting, set the original size.

 [SPECIFYING THE SCAN SIZE AND SEND SIZE](#) (page 4-47)

2

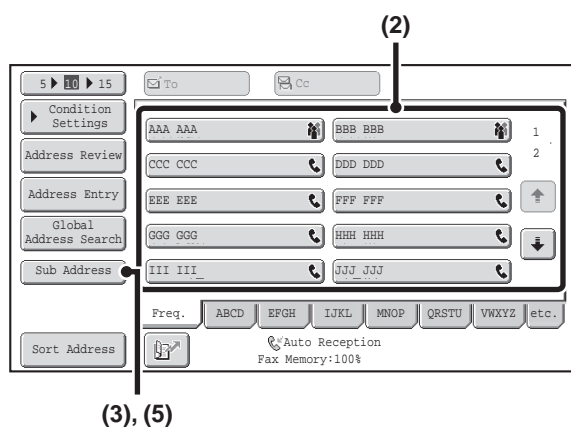

## Enter the destination fax number.

**(1) Touch the [Address Book] key in the base screen.**

For the [Address Book] key, see "[BASE SCREEN OF FAX MODE](#)" (page 4-8).

**(2) Touch the one-touch key of the desired destination.**

If the destination is not stored in the address book, enter the fax number with the numeric keys.

If the sub-address and passcode are stored in the one-touch key, the following sub-steps are not necessary. Go to step 3.

**(3) Touch the [Sub Address] key.**

"/" appears.

**(4) Enter the sub-address with the numeric keys.**

**(5) Touch the [Sub Address] key.**

"/" appears.

**(6) Enter the passcode with the numeric keys.**



If a passcode has been omitted in the memory box of the other machine, (5) and (6) are not necessary.

## 3 Press the [START] key.

3

Scanning begins.

- If you inserted the original pages in the document feeder tray, all pages are scanned. A beep will sound to indicate that scanning is finished.
- If you are scanning the original on the document glass, scan each page one page at a time. When scanning finishes, place the next original and press the [START] key. Repeat until all pages have been scanned and then touch the [Read-End] key. A beep will sound to indicate that scanning is finished.

When the relay machine receives the fax, it will automatically transmit the fax to each of the end receiving machines programmed in the memory box.



### To cancel scanning...

Press the [STOP] key () while the original is being scanned.

# RELAY BROADCAST TRANSMISSION USING F-CODES

When your machine receives a F-code relay request transmission, the fax is received to a F-code relay broadcast memory box in your machine. Your machine then relays the fax to each of the end receiving machines programmed in the memory box. Transmission to the end receiving machines takes place automatically.

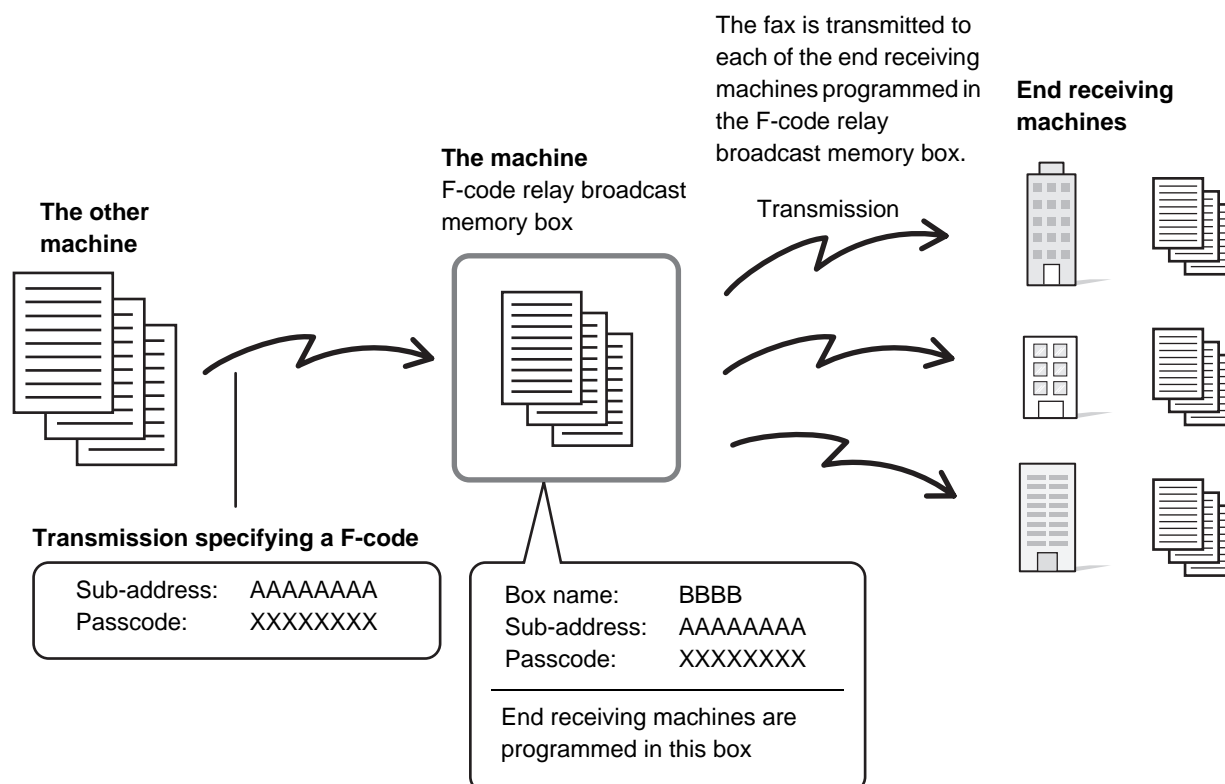

- Prior to the operation, inform the requesting party of the sub-address and passcode of the relay broadcast memory box in your machine.
- Program the end receiving machines in the F-code relay broadcast memory box when you create the box in your machine. [CREATING MEMORY BOXES IN THE MACHINE FOR F-CODE COMMUNICATION](#) (page 4-102)
- The end receiving machines do not need to support F-code communication.
- The machine that requests a relay broadcast transmission only bears the cost of sending the fax to your machine (the relay machine). Your machine bears the cost of sending the fax to each of the end receiving machines.
- When faxes forwarded using this function are printed at the forwarding destination, the date and time of reception cannot be printed on the faxes. ("Receiving Date & Time Print" is disabled.)

# USING AN EXTENSION PHONE

This section explains how to use an extension phone to make voice calls and receive a fax after talking with the other party.

## CONNECTING AND USING AN EXISTING PHONE (Extension Phone Connection)

You can connect an existing extension phone to the machine.

The phone can be used for voice calls and to start fax reception on the machine.

As an example, you can make a phone call using the existing phone, speak to the other party, and then press the [START] key to fax an original that has been placed to that party. You can also press the [START] key when an original is not placed to receive a fax.

Connect the extension phone as shown below.

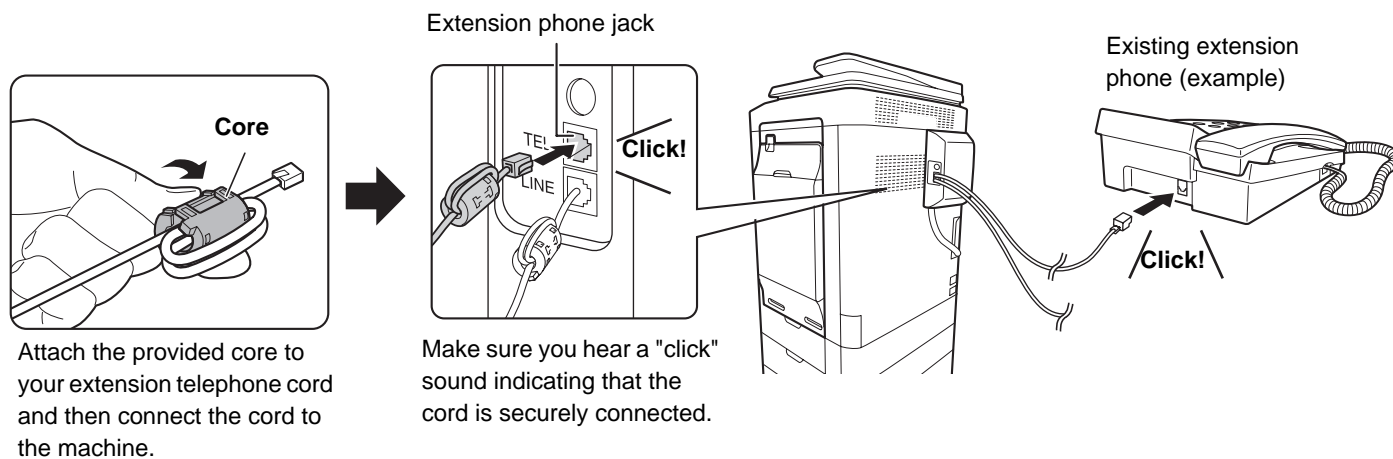

- Connect an extension phone that has a modular jack. Use standard phone line cable to connect the phone. If other than a standard phone line cable is used, the connection may not work correctly.
- If the plug on the telephone line cord does not fit into the jack on your extension phone, contact your dealer or nearest SHARP Service Department.



## RECEIVING A FAX AFTER ANSWERING A CALL ON THE EXTENSION PHONE (Remote Reception)

Follow the steps below if you need to start fax reception after answering a call and speaking on the extension phone. If you are on a pulse-dial (rotary) line, set the extension phone to issue tone signals.

1

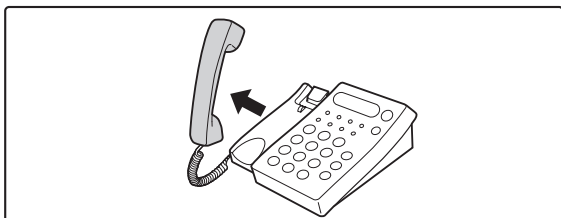

**When you hear ringing, answer the call on the extension phone.**

2

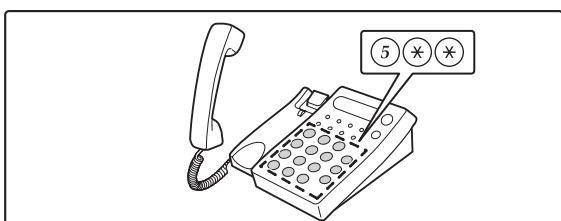

**Signal the machine to start fax reception.**

Press 5 \* \* on the keypad of the extension phone.

3

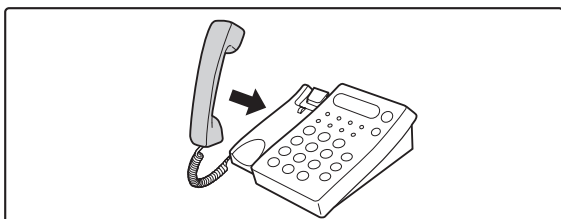

**Replace the extension phone.**

The machine sounds a beep when reception ends.



- **System Settings: [Receive Setting](#) (page 7-106)**

To use remote fax reception, set this setting to "Manual Reception".

- **System Settings (Administrator): [Remote Reception Number Setting](#)**

This is used to change the number used for remote fax reception. The factory default setting is "5".

## MAKING AND RECEIVING PHONE CALLS

You can make and receive normal calls on your extension phone. A phone call can also be made by dialing on the machine.

# CHECKING THE STATUS OF FAX JOBS

This section explains how to check the status of reserved transmission jobs and received faxes.

## JOB STATUS SCREEN

The job status screen is displayed when the [JOB STATUS] key on the operation panel is pressed. The job status screen shows the status of jobs by mode. When the [JOB STATUS] key is pressed, the job status screen of the mode that was being used before the key was pressed appears.

Reserved transmissions and received faxes are referred to as jobs here.

**Example: Pressing the key in fax mode**

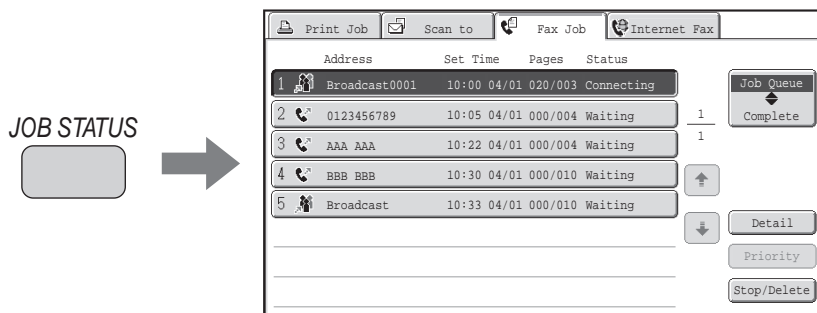

The job status display is in the lower left corner of the touch panel. The job status display can be touched to display the job status screen.

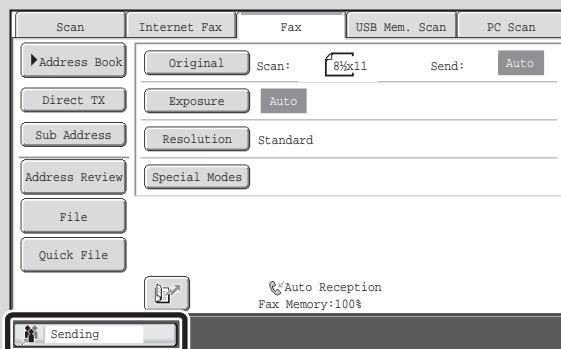

# JOB QUEUE SCREEN AND COMPLETED JOB SCREEN

The job status screen consists of two screens: the job queue screen, which shows reserved jobs and the job currently in progress, and the completed jobs screen. To switch between the two screens, touch the job status screen selector key ((2) below).

Job queue screen

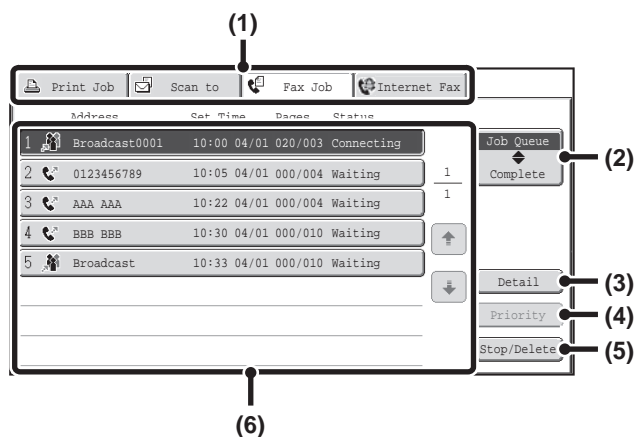

Completed job screen

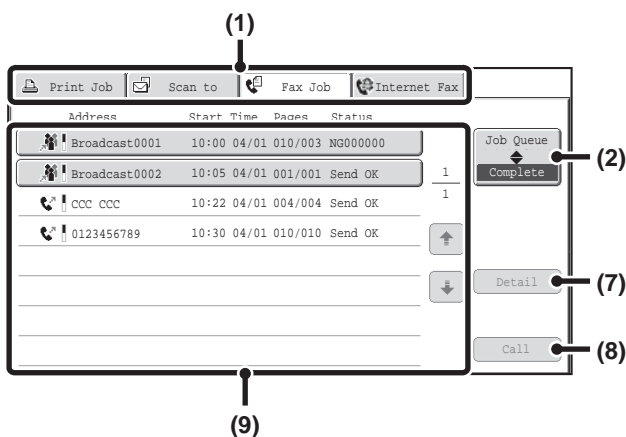

**(1) Mode select tabs**

Use these tabs to select the job status screen of each mode.

**(2) Job status screen selector key**

Touch this key to switch between the job queue screen and the completed jobs screen.

**(3) Job queue screen [Detail] key**

This shows detailed information on a broadcast transmission or serial polling job that is reserved or in progress. Select the key of the desired job in the job queue screen (6) and then touch the [Detail] key.

☞ [CHECKING A RESERVED JOB OR THE JOB IN PROGRESS](#) (page 4-124)

**(4) [Priority] key**

Touch this key to give priority to a selected job.

☞ [GIVING PRIORITY TO A RESERVED FAX JOB](#) (page 4-127)

**(5) [Stop/Delete] key**

Touch this key to stop or delete a selected job.

☞ [CANCELING A FAX IN PROGRESS OR A RESERVED FAX](#) (page 4-126)

**(6) Job queue screen**

Jobs are shown as keys in the order they were reserved. Each key shows information on a job and its current status.

☞ [Job key display](#) (page 4-121)

**(7) Completed jobs screen [Detail] key**

This shows detailed information on the results of completed broadcast transmission jobs, completed serial polling jobs, and completed jobs that used the document filing function. Select the key of the desired job in the completed jobs screen (9) and then touch the [Detail] key.

From the details screen, it is possible to resend the fax to destinations to which transmission was not successful.

☞ [CHECKING COMPLETED JOBS](#) (page 4-125)

**(8) [Call] key**

Touch this key to retrieve and use a transmission or reception job that was stored using the document filing function.

**(9) Completed jobs screen**

This shows up to 99 completed transmission/reception jobs. A description of each job and the result (status) are shown.

Broadcast transmission jobs, serial polling jobs, received fax forwarding jobs, and transmission/reception jobs that used the document filing function are indicated as keys.

## Job key display

The following information is shown in the job queue keys and completed job keys that appear in the job status screen.

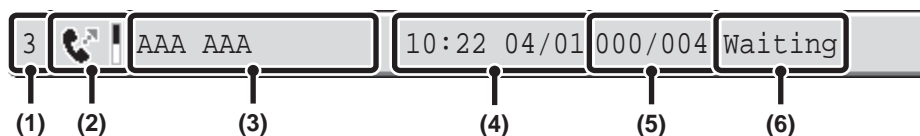

**(1) Indicates the number (position) of the job in the job queue.**

When the job currently being transmitted is finished, each job moves up one position in the job queue. This number does not appear in keys in the completed jobs screen.

**(2) Mode icon**

This indicates the type of job. In the completed jobs screen, a color bar indicating black & white will appear next to the icon. (However, the color bar icon does not appear in the key of a job that used document filing or in the key of a transmission/reception job that was canceled.)

Icon	Job type
	Fax transmission
	Fax reception
	Broadcast transmission, Serial polling or Inbound routing
	PC-Fax transmission

**(3) Name of other party**

For a transmission, the name or fax number of the destination. For a reception, the fax number of the sending party. In the case of a broadcast transmission or serial polling operation, "Broadcast" or "Multi Polling" appears together with a broadcast control number (4-digits).

**(4) Time reserved / Time started**

In the job queue screen, the date and time the job was reserved. In the completed jobs screen, the date and time the job was started.

**(5) Number of pages**

Shows the number of pages transmitted / total number of original pages.

**(6) Status**

Shows the job status.

- Job in progress

Message	Status
"Connecting"	Connecting
"Sending"	Sending
"Receiving"	Receiving
"Tel"	Speaking with the other party using an extension phone
"Stopped"	The job has been stopped.
"Error"	An error occurred while the job was being executed.

- Job waiting to be executed

Message	Status
"Waiting"	The job is waiting to be executed.
"Retry Mode"	The job is being re-attempted due to a communication error or other problem.
The day and time are displayed.	Timer transmission job (the specified time is displayed)

- Completed job

Message	Status
"Send OK"	Transmission completed.
"In Memory"	Reception completed but the fax has not been printed.
"Received"	A received fax has been printed or deleted in the check image screen.
"Forward OK"	The received fax has been forwarded.
"Stopped"	The job was stopped.
"Number of successful transmission destinations / Total destinations OK"	Completion of a broadcast transmission, serial polling or inbound routing operation. If transmission to 3 destinations was successful out of a total of 5, "003/005" will appear.
"No response"	An error occurred because there was no response from the destination.
"Busy"	An error occurred because the other party was busy.
"Reject Reception"	A fax was sent from a party that has been blocked by the anti junk fax function.
"NGxxxxxx"	Transmission/reception was not successful because a communication error occurred (a 6-digit error code appears in xxxxxx.)
"Error"	An error occurred while the job was being executed.

# OPERATION WHEN A JOB IN THE JOB QUEUE IS COMPLETED

When a normal transmission job is completed, it moves to the completed jobs screen and "Send OK" appears in the status column.

Received faxes, timer transmission jobs, retry jobs, and forwarding jobs are handled in the job status screen as explained below.

## Fax reception jobs

While a fax is being received, "Receiving" appears in the job queue screen.

When reception is completed, the job moves to the completed jobs screen and "In Memory" appears.

After the fax is printed, the status changes to "Printed".

## Timer transmission jobs

A timer transmission job appears at the bottom of the job queue screen until the specified time arrives.

When the specified time arrives, the job is executed. If another job is in progress, the timer job is started when the other job is completed.

## Retry jobs

A retry job appears at the bottom of the job queue screen. When the set retry interval elapses, the job is executed. If there are jobs reserved ahead of the retry job, the retry job is reserved at the bottom of the job queue and executed when its turn arrives.

## Fax reception jobs when Inbound Routing is enabled

When Inbound Routing is enabled in the Web pages, fax reception jobs are handled as follows depending on the print setting.

 [FORWARDING RECEIVED FAXES TO A NETWORK ADDRESS \(Inbound Routing Settings\)](#) (page 4-67)

- **Received fax is not printed**

"Receiving" appears in the job queue screen while the fax is being received. When reception is completed, the job moves to the job queue of the job status screen of scan mode.

- **Received fax is printed**

When reception is completed, the job moves to the completed jobs screen and "In Memory" appears. After the fax is printed, "Printed" appears. In addition, the job is added to the job queue of the job status screen of scan mode. When forwarding is finished, "Forward OK" appears.

## CHECKING A RESERVED JOB OR THE JOB IN PROGRESS

The detailed contents of a broadcast transmission or serial polling job can be displayed. Select (touch) the key of the job that you wish to check and touch the [Detail] key. The job details screen will appear (see below).

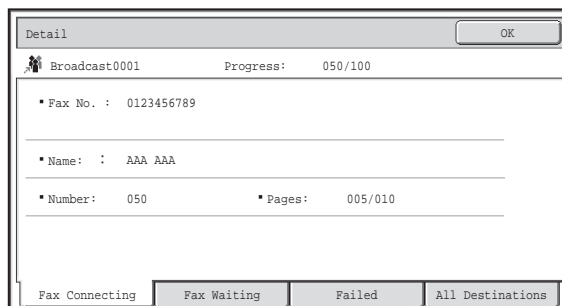

The job name and progress (number of completed destinations / total destinations) appear at the top of the screen. Touch a tab to display the information that appears on that tab. The following information appears on each tab.

Tab name	Information displayed
Fax Connecting	Information on the current destination appears. Fax No.: The fax number of the destination. Name: The name of the destination. Number: The broadcast control number (3-digits). Pages: Number of pages completed / total number of pages
Fax Waiting	This shows information on the destinations that are waiting. A broadcast control number (3-digits) appears in front of each destination. Address: The name of the other destination. Status: The status of communication.
Failed	This shows information on destinations for which communication failed. A broadcast control number (3-digits) appears in front of each destination. Address: The name or fax number of each destination. Start Time: The time when communication began. Status: The status of communication.
All Destinations	This shows all destinations specified in the job. A broadcast control number (3-digits) appears in front of each destination. Address: The name or fax number of the destination. Start time: The time at which communication began. Status: The status of communication.

## CHECKING COMPLETED JOBS

You can check a list of the destinations, the destinations for which transmission failed, and other detailed information on completed broadcast transmission jobs, received fax forwarding jobs, serial polling jobs, and jobs that used document filing. Touch the key of the desired job in the completed jobs screen and touch the [Detail] key. The job detail screen (see below) will appear.

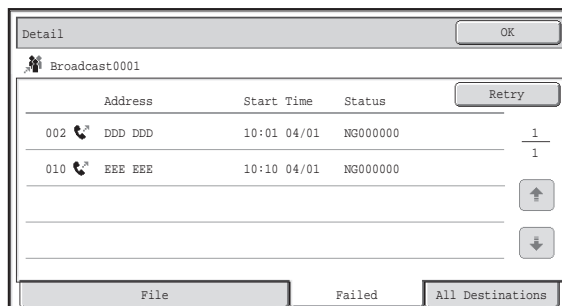

The job name appears at the top of the job detail screen.

To view details on the job, touch one of the tabs. The following information appears on each tab.

Tab name	Information displayed
File	Information on a transmission/reception that used document filing. To retrieve the file and use it, touch the [Call] key.
Failed	This shows information on destinations for which communication failed. A broadcast control number (3-digits) appears in front of each destination. Address: The name or fax number of each destination. Start time: Time at which communication began. Status: Description of failure (error) The [Retry] key can be touched to re-attempt transmission to that destination.*
All Destinations	Shows all addresses specified in the job. A broadcast control number (3-digits) appears in front of each destination. Address: The name or fax number of each destination. Start time: Time at which communication began. Status: Communication result The [Retry] key can be touched to transmit to all destinations again.*

\* Recalling is not possible for a broadcast transmission that includes a Scan to FTP address, Scan to Network Folder address, or Scan to Desktop address.



# CANCELING A FAX IN PROGRESS OR A RESERVED FAX

Follow the steps below to cancel a fax transmission that is in progress or a reserved fax job.

1

JOB STATUS



Press the [JOB STATUS] key.

2

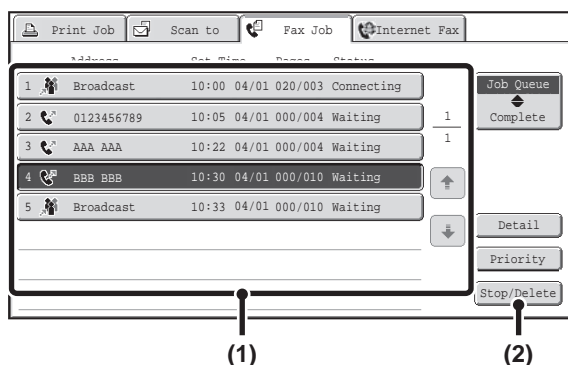

Select the fax job that you wish to cancel.

- (1) Touch the key of the fax job to be canceled.
- (2) Touch the [Stop/Delete] key.

3

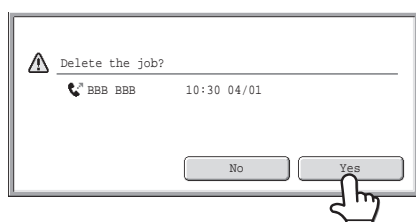

Touch the [Yes] key.



If you do not wish to cancel the selected fax job...  
Touch the [NO] key.



Printing of received faxes and forwarding jobs set using "Inbound Routing Settings" cannot be canceled.

 [FORWARDING RECEIVED FAXES TO A NETWORK ADDRESS \(Inbound Routing Settings\)](#) (page 4-67)

# GIVING PRIORITY TO A RESERVED FAX JOB

When multiple jobs are waiting to be transmitted, the jobs are normally transmitted in the order they were reserved. If you need to give priority to a job and send it ahead of the other jobs, follow the steps below.

1

JOB STATUS



Press the [JOB STATUS] key.

2

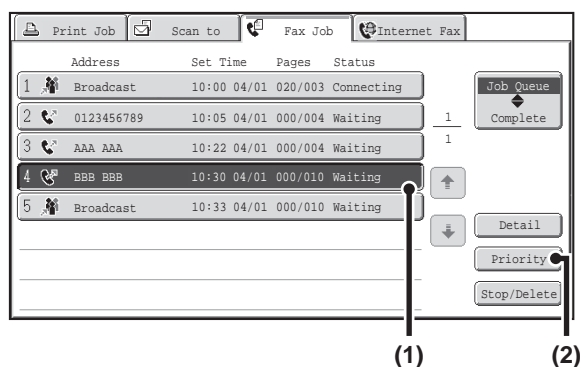

Select the fax job to which you wish to give priority.

(1) Touch the key of the desired job.

(2) Touch the [Priority] key.

The selected job moves up to the position immediately following the job in progress. The job will be executed when the job in progress is completed.



If the job in progress is a broadcast transmission job or a serial polling job, the priority job will be transmitted between destinations of the broadcast transmission or serial polling job. However, if the priority job is a broadcast transmission job or a serial polling job, it will be executed after the current job is completed.

---

---

# CHECKING THE ACTIVITY LOG (Image Sending Activity Report)

## IMAGE SENDING ACTIVITY REPORT

You can have the machine print a log of recent image sending activity (date, name of other party, time required, result, etc.). The Image Sending Activity Report contains useful information such as the types of errors that occurred.

The most recent 200 transactions are included in the report.

You can have the machine print the Image Sending Activity Report each time the number of transactions reaches 201, or at a specified time (once a day only).

 The contents of the Image Sending Activity Report are erased when the report is printed, and thus it cannot be reprinted.

 **System Settings (Administrator): Activity Report Print Select Setting**  
This is used to set the conditions for printing activity reports. The factory default setting is not to print.  
The Image Sending Activity Report can be set to print each time the number of transactions reaches 201, or at a specified time (once a day only).

## INFORMATION APPEARING IN THE RESULT COLUMN

Error types and other information are printed in the result column of transaction and activity reports. When a transaction report or activity report is printed, check the result of the transaction in the result column and take action as needed.

### Examples of messages that are printed in the result column

Message	Explanation
OK	The transaction was completed normally.
G3	Communication took place in G3 mode.
ECM	Communication took place in G3 ECM mode.
SG3	Communication took place in Super G3 mode.
Forwarding	The received data was forwarded.
NO RESPONSE	No response from the receiving party.
BUSY	Transmission was not possible because the other party was already using the line.
CANCEL	The transmission was canceled while in progress.
MEMORY OVER	The memory became full during quick on-line transmission.
MEM.FULL	The memory became full during reception.
LENGTH OVER	The transmitted fax was over 1.5 m (59") long and therefore could not be received.
ORIGINAL ERROR	Direct transmission or manual transmission was not successful because a misfeed occurred.
PASS# NG	The connection was broken because the polling passcode was not correct.
NO RX POLL	The machine that was polled does not have a polling function.
RX POLL FAIL	The other machine refused the polling operation, or your machine broke the connection when polled because no data was in memory.
NO F-CODE POLL	The other machine refused a F-code polling operation, or your machine broke the connection when polled because no data was in its F-code memory polling box.
RX POLL# NG	The connection was broken because the sub-address for F-code polling memory was not valid.
F POLL PASS# NG	The connection was broken because the passcode for F-code polling memory was not valid.
BOX NO. NG	Your machine broke the connection because the specified sub-address for a F-code memory box does not exist.
F PASS# NG	Your machine broke the connection because the other machine sent an incorrect passcode for F-code communication.
RX NO F-CODE POLL	F-code polling was attempted, however, the other machine did not have a F-code polling memory box.
NO F FUNC	F-code communication was attempted, however, the other machine does not support F-code communication.
NO F-CODE	F-code communication was refused by the other machine because of an incorrect sub-address or other reason.
M. BOX: [xxxxxx] *****	Data was received to a confidential or relay broadcast memory box, or data was sent from a memory polling box. The name of the memory box appears in [xxxxxx], and the type of F-code operation (relay request reception, polling memory transmission, or confidential reception) appears in *****.
FAIL xx (xxxx)	The transaction failed due to a communication error. First 2 digits of communication error number: Error code from 00 to 99. Last 4 digits of communication error number: Code for use by service technicians.
REJECTED	A fax was sent from a party from which reception is blocked.

# FACSIMILE SPECIFICATIONS

<b>Applicable telephone line</b>	Public switched telephone network, PBX	
<b>Scanning resolution (supports ITU-T standards)</b>	8 x 3.85 lines/mm (Standard), 8 x 7.7 lines/mm (Fine, Fine-Halftone), 8 x 15.4 lines/mm (Super Fine, Super Fine - Halftone), 16 x 15.4 lines/mm (Ultra Fine, Ultra Fine - Halftone)	
<b>Transmission speed</b>	33.6 kbps down to 2.4 kbps Automatic fallback	
<b>Compression method</b>	MH / MR / MMR / JBIG	
<b>Transmission modes</b>	Super G3, G3 (the machine can only send faxes to and receive faxes from machines that support G3 or Super G3)	
<b>Input document size</b>	Inch sizes: 8-1/2" x 14", 8-1/2" x 13-2/5", 8-1/2" x 13", 8-1/2" x 11", 5-1/2" x 8-1/2" AB sizes: A4, B5, A5, 216 mm x 330 mm, 216 mm x 340 mm, 216 mm x 343 mm, 16K Long originals (max. width 8-1/2" (216 mm) x max. length 19-5/8" (500 mm) can be transmitted using the automatic document feeder. Scanning one side is possible.)	
<b>Paper sizes</b>	8-1/2" x 14", 8-1/2" x 13-2/5", 8-1/2" x 13", 8-1/2" x 11", 5-1/2" x 8-1/2" (A4, B5, A5)	
<b>Transmission time *1</b>	Approx. 2 seconds (Super G3 mode/33.6 kbps, JBIG) Approx. 6 seconds (G3 ECM mode/14.4 kbps)	
<b>Remarks</b>	Extension telephone connection	Possible (1 telephone)
	Number of one-touch keys for storing destinations*2	Maximum number of keys: 999
	Number of destinations that can be stored in a group (1 key)*2	Maximum number of destinations in one group (1 key): 500
	Timer transmission	Yes
	Program function	Yes (48 programs)
	F-code transmission	Supported (SUB/SEP (sub-address) and SID/PWD (passcode) signals can be transmitted / received)
	Image memory	8 MB standard

\*1 Transmission speed is for an 8-1/2" x 11" or A4 document with approximately 700 characters at standard resolution (8 x 3.85 lines/mm) sent in high speed mode (33.6 kbps (JBIG) or 14.4 kbps). This is only the time required to transmit the image information; the time required to send protocol signals is not included. Actual transmission times will vary depending on the contents of the document, the receiving machine type, and telephone line conditions.

\*2 Total number of all destinations (Scan to E-mail, Scan to FTP, Scan to Desktop, Scan to Network folder, Internet Fax, Fax and Group)

# CHAPTER 5

# SCANNER/INTERNET FAX

This chapter provides detailed explanations of the procedures for using the scanner function and the Internet fax function.

To use the Internet fax function, the internet fax function must be available.

**USB memory mode can be used without installing a peripheral device.**

## BEFORE USING THE MACHINE AS A NETWORK SCANNER

### NETWORK SCANNER FUNCTION . . . . . 5-3

### PREPARATIONS FOR USE AS A NETWORK SCANNER . . . . . 5-5

- MAKE SURE THE MAIN POWER SWITCH IS IN THE "ON" POSITION . . . . . 5-5
- CHECKING THE DATE AND TIME . . . . . 5-5
- STORING SENDER INFORMATION . . . . . 5-5
- SETTINGS REQUIRED IN THE WEB PAGES . . . . . 5-6
- STORING DESTINATION ADDRESSES FOR EACH SCAN MODE IN THE ADDRESS BOOK . . . . . 5-6
- STORING A DESTINATION FOR SCAN TO DESKTOP . . . . . 5-7
- BEFORE SENDING TO A DIRECT SMTP ADDRESS . . . . . 5-8

### BASE SCREEN . . . . . 5-9

- ADDRESS BOOK SCREEN . . . . . 5-13
- CHANGING THE DISPLAY OF ONE-TOUCH KEYS IN THE ADDRESS BOOK SCREEN . . . . . 5-14

### SCAN SEND SEQUENCE . . . . . 5-16

## ENTERING DESTINATIONS

### RETRIEVING A DESTINATION FROM THE ADDRESS BOOK . . . . . 5-18

- RETRIEVING A DESTINATION . . . . . 5-19
- CHECKING AND DELETING THE SELECTED DESTINATIONS . . . . . 5-20

### USING A SEARCH NUMBER TO RETRIEVE A DESTINATION . . . . . 5-21

### ENTERING AN ADDRESS MANUALLY . . . . . 5-22

- SPECIFYING A NETWORK FOLDER . . . . . 5-23

### RETRIEVING A DESTINATION FROM A GLOBAL ADDRESS BOOK . . . . . 5-25

### USING THE RESEND FUNCTION . . . . . 5-27

## TRANSMITTING AN IMAGE

### SENDING AN IMAGE IN SCAN MODE . . . . . 5-28

- CHANGING THE SUBJECT, FILE NAME, REPLY-TO, AND BODY TEXT . . . . . 5-33

### SENDING AN IMAGE IN USB MEMORY MODE . . . . . 5-36

- ENTERING A FILE NAME . . . . . 5-41

### SENDING A FAX IN INTERNET FAX MODE . . . . . 5-42

- CHANGING THE SUBJECT, FILE NAME, AND BODY TEXT . . . . . 5-45

### SENDING THE SAME IMAGE TO MULTIPLE DESTINATIONS (Broadcast Transmission) . . . . . 5-48

- BROADCAST TRANSMISSIONS THAT INCLUDE INTERNET FAX DESTINATIONS . . . . . 5-51

### SENDING AN INTERNET FAX FROM A COMPUTER (PC-I-Fax) . . . . . 5-53

### IMAGE SETTINGS . . . . . 5-54

- AUTOMATICALLY SCANNING BOTH SIDES OF AN ORIGINAL (2-Sided Original) . . . . . 5-55
- SPECIFYING THE ORIGINAL SCAN SIZE AND SEND SIZE . . . . . 5-56
- CHANGING THE EXPOSURE AND ORIGINAL IMAGE TYPE . . . . . 5-64
- CHANGING THE RESOLUTION . . . . . 5-66
- CHANGING THE FILE FORMAT . . . . . 5-67
- CHANGING THE COLOR MODE . . . . . 5-71

### CHECKING THE IMAGE TO BE TRANSMITTED (Preview) . . . . . 5-72

- PREVIEW CHECK SCREEN . . . . . 5-73



**SPECIAL MODES**

**SPECIAL MODES** ..... 5-74

**STORING SCAN OPERATIONS (Programs)** .... 5-76

**ERASING PERIPHERAL SHADOWS ON THE IMAGE (Erase)** ..... 5-78

**SENDING AN IMAGE AT A SPECIFIED TIME (Timer Transmission)** ..... 5-81

**SCANNING BOTH SIDES OF A CARD ONTO A SINGLE PAGE (Card Shot)** ..... 5-83

**SCANNING MANY ORIGINALS AT ONCE (Job Build)** ..... 5-86

**SCANNING THIN ORIGINALS (Slow Scan Mode)** ..... 5-88

**CHECKING THE NUMBER OF SCANNED ORIGINAL SHEETS BEFORE TRANSMISSION (Original Count)** ..... 5-90

**ELIMINATING BLANK PAGES FROM A TRANSMISSION (Blank Page Skip)** ..... 5-92

**SCANNING BUSINESS CARDS (Business Card Scan)** ..... 5-94

**SCAN THE ORIGINAL DELETING THE COLORED PORTIONS (Drop Out Color)** ..... 5-95

**WHITENING FAINT COLORS IN THE IMAGE (Suppress Background)** ..... 5-97

**CHANGING THE PRINT SETTINGS FOR THE TRANSACTION REPORT (Transaction Report)**... 5-99

**CHECKING THE STATUS OF TRANSMISSION/RECEPTION JOBS**

**JOB STATUS SCREEN** ..... 5-101

- **JOB QUEUE SCREEN AND COMPLETED JOB SCREEN** ..... 5-102
- **OPERATION WHEN A JOB IN THE JOB QUEUE IS COMPLETED** ..... 5-105
- **CHECKING COMPLETED JOBS** ..... 5-106

**STOPPING A SCAN JOB BEING TRANSMITTED OR WAITING TO BE TRANSMITTED** ..... 5-107

**GIVING PRIORITY TO A SCAN TRANSMISSION JOB** ..... 5-108

**CHECKING THE INTERNET FAX ACTIVITY LOG (Image Sending Activity Report)** ..... 5-109

- **IMAGE SENDING ACTIVITY REPORT** .... 5-109
- **INFORMATION APPEARING IN THE RESULT COLUMN** ..... 5-109

**INTERNET FAX RECEPTION FUNCTIONS**

**RECEIVING AN INTERNET FAX** ..... 5-110

- **MANUALLY RECEIVING INTERNET FAXES** ..... 5-111

**PRINTING A PASSWORD-PROTECTED FAX (Hold Setting For Received Data Print)** ..... 5-112

**CHECKING THE IMAGE BEFORE PRINTING** .. 5-113

- **IMAGE CHECK SCREEN** ..... 5-114

**FORWARDING RECEIVED INTERNET FAXES TO A NETWORK ADDRESS (Inbound Routing Settings)** ..... 5-115

- **CONFIGURING INBOUND ROUTING SETTINGS** ..... 5-115

**SCANNING FROM A COMPUTER (PC Scan Mode)**

**BASIC SCANNING PROCEDURE** ..... 5-119

**METADATA DELIVERY**

**METADATA DELIVERY (Data Entry)** ..... 5-124

**PREPARATIONS FOR METADATA TRANSMISSION** ..... 5-125

- **SETTINGS REQUIRED IN THE WEB PAGES** ..... 5-125
- **METADATA TRANSMISSION FOR SCAN TO DESKTOP** ..... 5-125

**TRANSMITTING METADATA** ..... 5-126

- **METADATA FIELDS** ..... 5-128

**NETWORK SCANNER / INTERNET FAX\*1 SPECIFICATIONS** ..... 5-129

**PULL SCAN FUNCTION (TWAIN) SPECIFICATIONS** ..... 5-130

# BEFORE USING THE MACHINE AS A NETWORK SCANNER

This section provides information that you should know before using the machine as a network scanner.

## NETWORK SCANNER FUNCTION

The network scanner function of the machine can be used to scan an original, create an image file, and send the file over a network to a computer, FTP server, or other destination. Scanning is also possible from your computer using a TWAIN-compliant application.

The network scanner function provides the following scanning modes.

### Scan modes

 [SENDING AN IMAGE IN SCAN MODE](#) (page 5-28)

#### Scan to E-mail

The scanned file is sent to an e-mail address.



#### Scan to FTP

The scanned file is sent to a specified directory of a FTP server. When the file is sent, it is also possible to send an e-mail to a previously stored e-mail address to inform the recipient of the location of the file. (This is called "Scan to FTP (Hyperlink)".)



#### Scan to Desktop

The scanned file is sent to a specified folder on your computer. To use Scan to Desktop, software must be installed from the "Sharpdesk/Network Scanner Utilities" CD-ROM that accompanies the machine. For the system requirements of the software, see the manual (PDF format) or the Readme file on the CD-ROM. For the procedures for installing the software, see the "Sharpdesk Installation Guide".



#### Scan to Network Folder

The scanned file is sent to a shared folder on a Windows computer on the same network as the machine.





## USB memory mode

 [SENDING AN IMAGE IN USB MEMORY MODE](#) (page 5-36)

### USB Memory Scan

The scanned file is sent to and stored in a USB memory device connected to the machine.



## Internet fax mode

To use the Internet fax function, the Internet fax expansion kit must be installed.

 [SENDING A FAX IN INTERNET FAX MODE](#) (page 5-42)

### Internet fax transmission

The scanned file is sent as an Internet fax. Reception of Internet faxes is also possible. The machine supports Direct SMTP, which lets you directly send Internet faxes within your company without using a mail server.

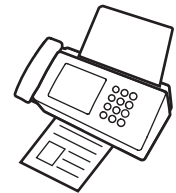

## PC scan mode

 [SCANNING FROM A COMPUTER \(PC Scan Mode\)](#) (page 5-119)

### PC Scan

A TWAIN-compliant application on a computer connected to the same network as the machine is used to scan a document or image.

To use PC Scan, the scanner driver must be installed from the "Software CD-ROM" that accompanies the machine.

Operating systems that can be used are Windows 2000/XP/Server 2003/Vista/Server 2008/7.



## Data entry mode

The application integration module is required to use the metadata transmission function.

 [METADATA DELIVERY](#) (page 5-124)

### Metadata delivery

The application integration module can be combined with the network scanner function to append a metadata\* file to a scanned image file. (This is called metadata delivery.)

Information entered using the touch panel or automatically generated by the machine can be sent to a directory on a FTP server or an application on a computer as a metadata file in XML format.

\* Metadata is information about a file, how it is to be processed, and its relation to other objects.

# PREPARATIONS FOR USE AS A NETWORK SCANNER

## MAKE SURE THE MAIN POWER SWITCH IS IN THE "ON" POSITION

The main power is "on" when the main power indicator on the right side of the operation panel is lit.

If the main power indicator is not lit, the main power is "off". Switch the main power switch to the "on" position and press the [POWER] key (⏻) on the operation panel.

If the Internet fax function will be used, and in particular if reception or timer transmission will take place at night, always keep the main power switch in the "on" position.

 When the [POWER SAVE] key (Ⓜ) indicator light is blinking, the machine is in auto power shut-off mode. If the [POWER SAVE] key (Ⓜ) is pressed when the indicator is blinking, the indicator will turn off and the machine will return to the ready state after a brief interval.

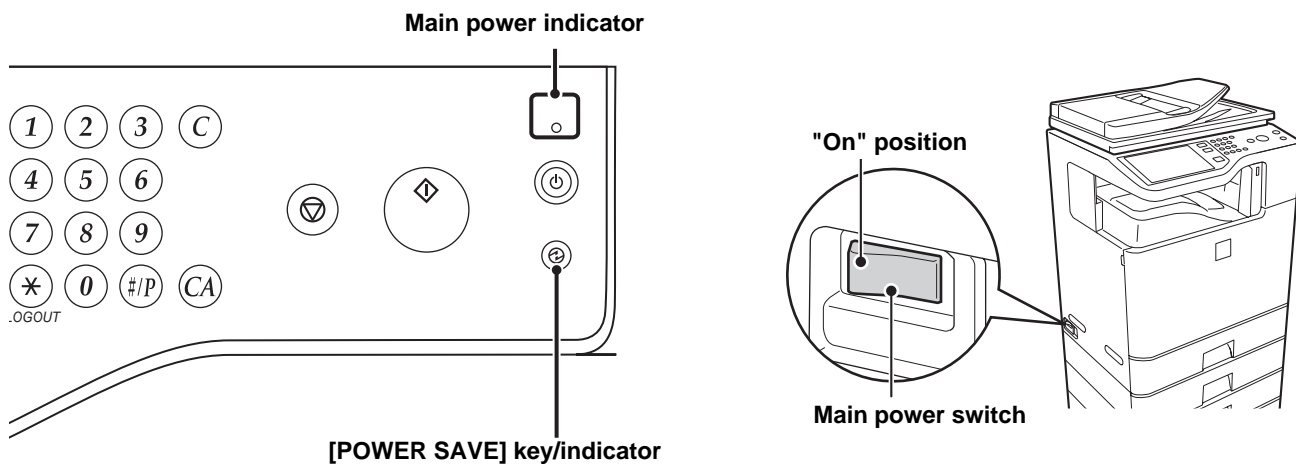

## CHECKING THE DATE AND TIME

Verify that the correct date and time are set in the machine.

The date and time are set in the system settings of the machine. When the [SYSTEM SETTINGS] key is pressed, the system settings menu screen appears on the touch panel. Select [Default Settings], [Clock], and [Clock Adjust], and set the year, month, day, hour, and minute.

 If "Disabling of Clock Adjustment" has been enabled in the system settings (administrator), the date and time cannot be set.

## STORING SENDER INFORMATION

Be sure to configure this information, as it is required for communication.

### Before using Scan to E-mail

Store a default sender name in "Sender Name" and a reply e-mail address in "Reply E-mail Address". These will be used when a sender is not selected.

 **System Settings (Administrator): Default Sender Set**  
This is used to store the sender name and e-mail address that is used when a sender is not selected.

### Before using Internet fax

Store a sender name in "Sender Name" and a sender Internet fax address in "Own Address".

 **System Settings (Administrator): Sender Data Registration**  
Use this setting to program the sender name and sender address.

## SETTINGS REQUIRED IN THE WEB PAGES

To use scan mode and Internet fax mode, the basic network scanner settings, server settings such as SMTP and DNS server settings, and sender addresses must be configured in the Web pages.

- **Server settings**

To configure server settings, click [Network Settings] and then [Services Settings] in the Web page menu. (Administrator rights are required.)

- **Basic network scanner settings**

To configure network scanner settings, click [Application Settings] and then [Network Scanner Settings] in the Web page menu. (Administrator rights are required.)

- **Internet fax settings**

To configure the network scanner settings, click [Application Settings] and then [Internet Fax Settings] in the Web page menu. (Administrator rights are required.)

## STORING DESTINATION ADDRESSES FOR EACH SCAN MODE IN THE ADDRESS BOOK

To use Scan to FTP, Scan to Desktop, and Scan to Network Folder, destinations must be stored in the address book. Although destinations for Scan to E-mail and Internet fax do not need to be stored in the address book (they can be entered directly or looked up in a global address book at the time of transmission), storing these types of destinations in the address book makes it easy to select them. Store each type of destination as explained below.

### Types of transmission in scanner mode

- Scan to FTP: Click [Address Book] in the Web page menu and then click the [Add] button. Select [FTP] in [Address Type] and store an address.
- Scan to Network Folder: Click [Address Book] in the Web page menu and then click the [Add] button. Select [Network Folder] in [Address Type] and store an address.
- Scan to E-mail: Click [Address Book] in the Web page menu and then click the [Add] button. Select [E-mail] in [Address Type] and store an address. Addresses can also be stored in the system settings.
- Scan to Desktop: See "[STORING A DESTINATION FOR SCAN TO DESKTOP](#)" (page 5-7). Scan to Desktop destinations can also be stored in the Web pages. Click [Address Book] in the Web page menu and then click the [Add] button. Select [Desktop] in [Address Type] and store an address.



A total of 999 addresses can be stored. Among these, a combined maximum of 200 Scan to Network Folder, Scan to FTP, and Scan to Desktop addresses can be stored.

### Transmission in Internet fax mode:

Click [Address Book] in the Web page menu and then click the [Add] button. Select [Internet Fax] or [Direct SMTP] for the [Address Type], and store the address. Addresses can also be stored in the system settings.



### System Settings: [Address Book](#) (page 7-17)

This is used to store destination addresses for Scan to E-mail and Internet fax.

# STORING A DESTINATION FOR SCAN TO DESKTOP

To store your computer in the machine as a destination for Scan to Desktop, Network Scanner Tool must be installed from the "Sharpdesk/Network Scanner Utilities" CD-ROM that accompanies the machine. To scan an image to your computer, Network Scanner Tool must be running on your computer.

## INSTALLING NETWORK SCANNER TOOL

To install Network Scanner Tool, see the "Sharpdesk Installation Guide" that accompanies the machine. When a standard installation is performed, Network Scanner Tool is installed with Sharpdesk.

When you restart your computer after installing Network Scanner Tool, the Setup Wizard will start automatically. Follow this wizard to set up Network Scanner Tool. This will store your computer in the machine as a destination for Scan to Desktop. The stored destination will be displayed as a one-touch key in the address book screen.

The following window appears while Network Scanner Tool is being set up. The item selected in "My Profiles" (C) will be the name of the one-touch key.

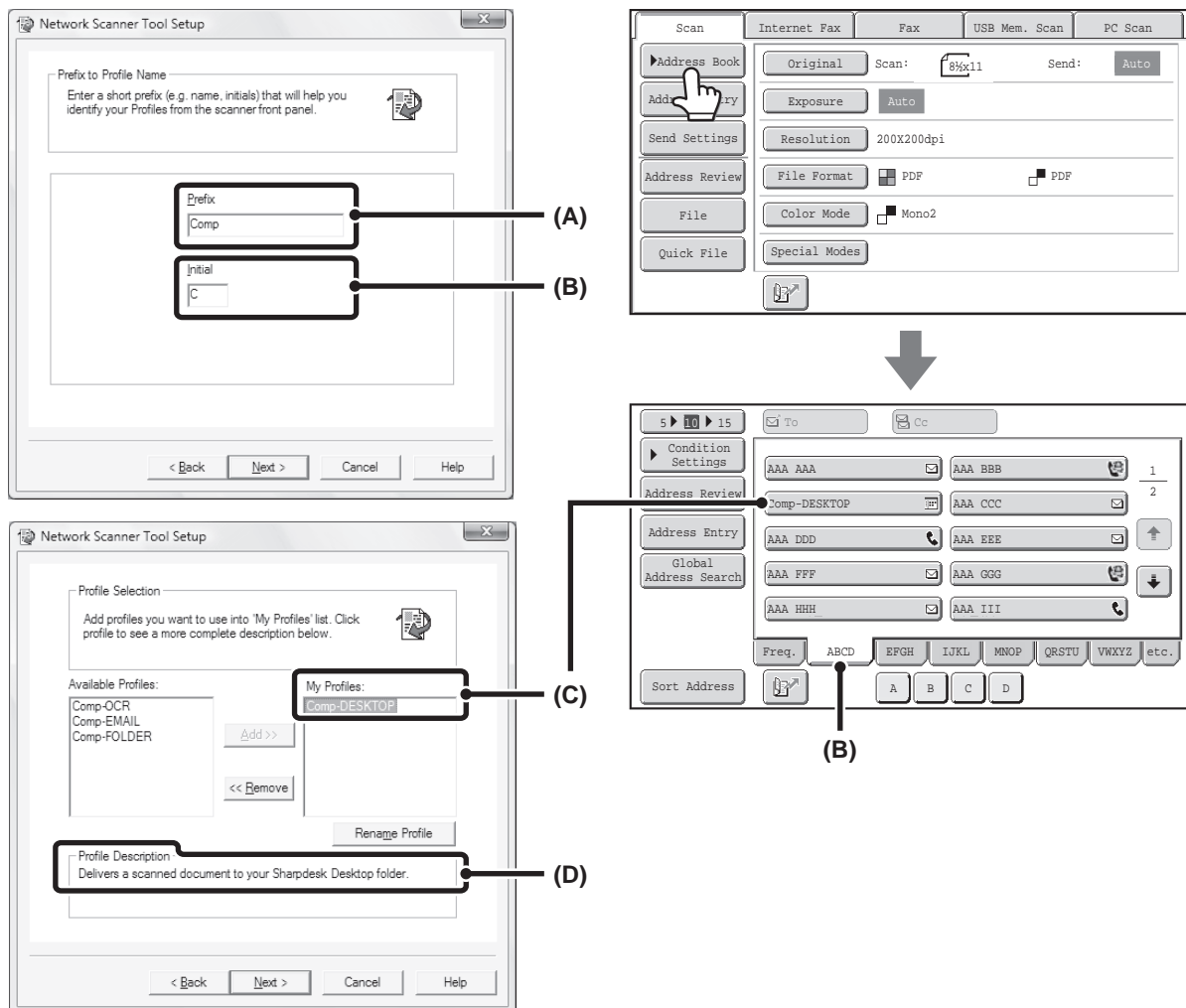

The profile name is determined by the combination of the text entered in "Prefix" (A) and the profile\*.

The one-touch key is assigned to an index tab in the address book screen based on the text entered in "Initial" (B).

\* This defines how an image sent to your computer is processed. For more information, see profile explanation (D).

## ADDING DESTINATIONS

For the number of computers that can be stored in the machine as destinations of Scan to Desktop, see the number of licenses indicated in the "Sharpdesk Installation Guide". To store more destinations, a license kit is required. Store Scan to Desktop destinations by installing Network Scanner Tool on each computer.

## BEFORE SENDING TO A DIRECT SMTP ADDRESS

The machine supports Direct SMTP, which lets you directly send Internet faxes within your company without using a mail server. For the procedure for storing a Direct SMTP address in the address book, see "[STORING DESTINATION ADDRESSES FOR EACH SCAN MODE IN THE ADDRESS BOOK](#)" (page 5-6). Stored Direct SMTP addresses are included in the address book for Internet fax mode.

### If the destination is busy

If the destination is busy, the machine will wait briefly and then automatically resend.



#### To cancel transmission...

Cancel the transmission from the job status screen.

[STOPPING A SCAN JOB BEING TRANSMITTED OR WAITING TO BE TRANSMITTED](#) (page 5-107)



#### System Settings (Administrator): Recall in Case of Line Busy

This is used to set the number of recall attempts and the interval between attempts when the connection cannot be established because the line is busy. The factory default setting is 2 attempts at an interval of 3 minutes.

### When a communication error occurs

If a communication error occurs or the other fax machine does not answer the call within a preset period of time, transmission will be re-attempted automatically after a preset interval.



#### To cancel transmission...

Cancel the transmission from the job status screen.

[STOPPING A SCAN JOB BEING TRANSMITTED OR WAITING TO BE TRANSMITTED](#) (page 5-107)



#### System Settings (Administrator): Recall in Case of Communication Error

This is used to set the number of recall attempts and the interval between attempts when a transmission fails due to an error. The factory default setting is attempt at an interval of 3 minutes.

# BASE SCREEN

Scan mode, USB memory mode, Internet fax mode, and PC scan mode are used by selecting operations and settings in the base screens of those modes. To display the base screen of a mode, touch the [IMAGE SEND] key in the touch panel and then touch the tab of the mode that you wish to use.

Base screen of scan mode

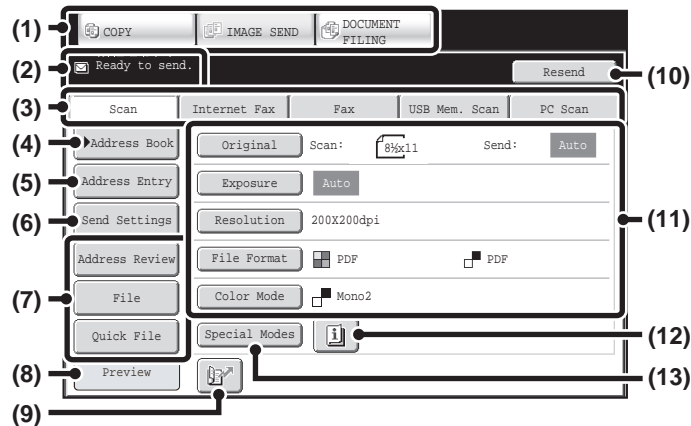

Base screen of USB memory mode

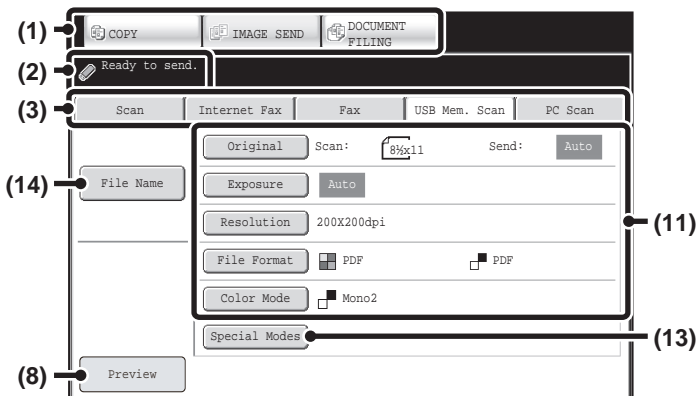

Base screen of Internet fax mode

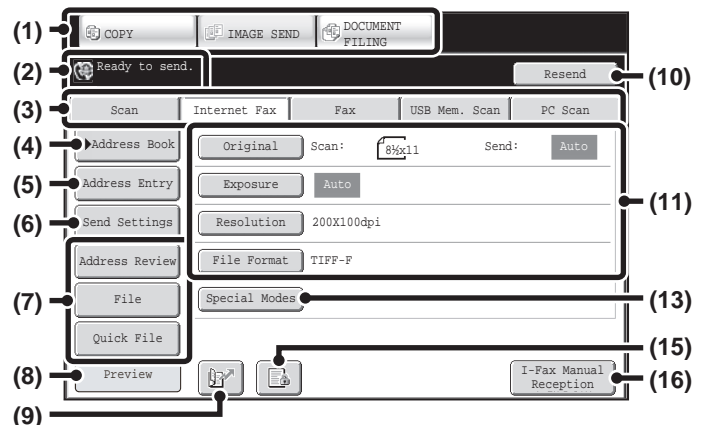

## (1) Mode select keys

Use these keys to switch between copy, image send, and document filing modes.



To use scan mode, USB memory mode, Internet fax mode, PC scan mode, or data entry mode, touch the [IMAGE SEND] key.

## (2) Various messages are displayed here.

The icon of the selected mode appears on the left.

## (3) Send mode tabs

Touch one of these tabs to change the image send mode.

Tabs of modes that cannot be used because the corresponding options are not installed do not appear. If the [USB Mem. Scan] and [PC Scan] tabs do not appear, touch the  tab to move the screen. If the [Scan], [Internet Fax], [Fax], and [Data Entry] tabs do not appear, touch the  tab to move the screen.

The [Data Entry] tab appears when the application integration module is installed. For information on

metadata delivery using the [Data Entry] tab, see "METADATA DELIVERY" (page 5-124).

## (4) [Address Book] key

Touch this key to use a one-touch key or a group key. When the key is touched, the address book screen appears.

 [RETRIEVING A DESTINATION FROM THE ADDRESS BOOK](#) (page 5-18)

## (5) [Address Entry] key

Touch this key to manually enter a destination address instead of using a one-touch key.

 [ENTERING AN ADDRESS MANUALLY](#) (page 5-22)

## (6) [Send Settings] key

Touch this key to select or enter the subject, file name, sender name, or body text, which has been previously stored in the Web page.

Scan modes:

 [CHANGING THE SUBJECT, FILE NAME, REPLY-TO, AND BODY TEXT](#) (page 5-33)

Internet fax mode:

 [CHANGING THE SUBJECT, FILE NAME, AND BODY TEXT](#) (page 5-45)

**(7) Customized keys**

The keys that appear here can be changed to show the settings or functions that you prefer.

☞ [Customizing displayed keys](#) (page 5-12)

**(8) [Preview] key \*1**

Touch to check the image that will be sent in the touch panel before transmission.

☞ [CHECKING THE IMAGE TO BE TRANSMITTED \(Preview\)](#) (page 5-72)

**(9)  key**

Touch this key to specify a destination using a search number\*.

\* 3-digit number assigned to a destination when it is stored.

☞ [USING A SEARCH NUMBER TO RETRIEVE A DESTINATION](#) (page 5-21)

**(10) [Resend] key/[Next Address] key**

The destinations of the most recent 8 transmissions by Scan to E-mail, fax and/or Internet fax are stored. Touch this key to select one of these destinations. After a destination is selected, this key changes to the [Next Address] key.

☞ [USING THE RESEND FUNCTION](#) (page 5-27)

☞ [RETRIEVING A DESTINATION](#) (page 5-19)

**(11) Image settings**

Touch this key to select the image settings (original size, exposure, resolution, file format, and color mode).

☞ [IMAGE SETTINGS](#) (page 5-54)

**(12)  key**

This key appears when a special mode or 2-sided scanning is selected. Touch the key to display the selected special modes.

☞ [Checking what special modes are selected](#) (page 5-12)

**(13) [Special Modes] key**

Touch this key to use a special mode.

☞ [SPECIAL MODES](#) (page 5-74)

**(14) [File Name] key**

Touch this key to enter a file name when storing a file to USB memory.

☞ [ENTERING A FILE NAME](#) (page 5-41)

**(15)  /  /  key**

When "Hold Setting for Received Data Print" or "Received Data Image Check Setting" is enabled in the system settings (administrator), this will appear when an Internet fax is received.

 : Only "Hold Setting for Received Data Print" is enabled

 : Only "Received Data Image Check Setting" is enabled

 : Both settings are enabled

☞ [PRINTING A PASSWORD-PROTECTED FAX \(Hold Setting For Received Data Print\)](#) (page 5-112)

☞ [CHECKING THE IMAGE BEFORE PRINTING](#) (page 5-113)

**(16) [I-Fax Manual Reception] key**

Touch this key to receive an Internet fax manually.

☞ [MANUALLY RECEIVING INTERNET FAXES](#) (page 5-111)

\*1 MX-B402SC Only

When sending an image, you can retrieve and use a stored transmission destination from the address book screen. The address book screen is shared by scan mode, Internet fax mode, fax mode and data entry mode.

Touch the [Address Book] key in the base screen to switch to the address book screen. Touch the [Condition Settings] key in the address book screen to switch to the base screen.

**Base screen of scan mode**

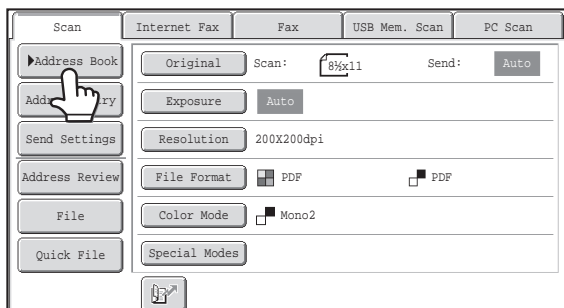

**Address book screen**

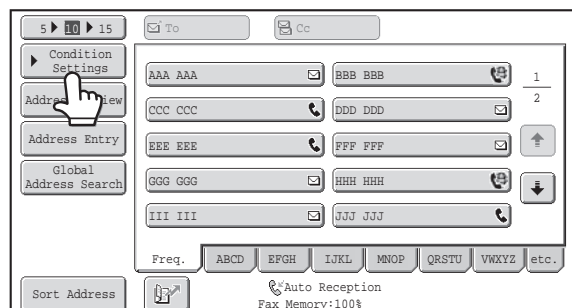

- This chapter uses the base screen of scan mode as an example when operations common to all modes are explained.
- The procedures in this chapter assume that the base screen of scan mode appears when the [IMAGE SEND] key is touched.

**System Settings (Administrator): Default Display Settings**

One of the following screens can be selected for the initial screen that appears when the [IMAGE SEND] key is touched.

- Base screen of each mode (scan, Internet fax, fax, or data entry mode)
- Address book screen



## Customizing displayed keys

Special mode keys and other keys can be displayed in the base screen. Set these keys to functions that you frequently use to access the functions with a single touch. The customized keys are configured using "Customize Key Setting" in the Web pages. The following keys appear by factory default:

- **[Address Review] key**

Touch this key to display a list of the destinations that have been selected in the address book. This is the same key as the [Address Review] key in the address book screen.

- **[File] key, [Quick File] key**

Touch either of these keys to use the File function or Quick File function of document filing mode.

### In USB memory mode...

Customized keys do not initially appear, however, up to three keys can be added.

### Example: When "Erase", "Job Build", and "Slow Scan Mode" are assigned to the customized keys

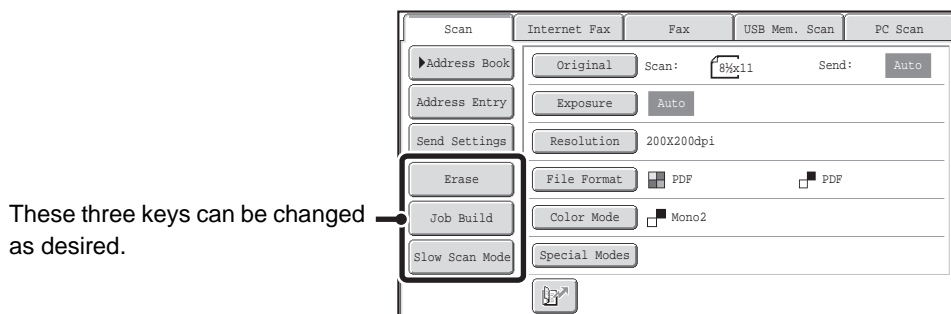

These three keys can be changed as desired.



- Displaying a program key in the base screen will enable you to retrieve the program by simply touching the key. [STORING SCAN OPERATIONS \(Programs\)](#) (page 5-76)
- The functions that can be selected for the customized keys vary depending on the mode.



#### System Settings (Administrator): Customize Key Setting

Registration is performed in [System Settings] - [Operation Settings] - "Customize Key Setting" in the Web page menu.

## Checking what special modes are selected

The key appears in the base screen when a special mode or 2-sided scanning is selected.

The key can be touched to display the selected special modes. To close the screen, touch the [OK] key.

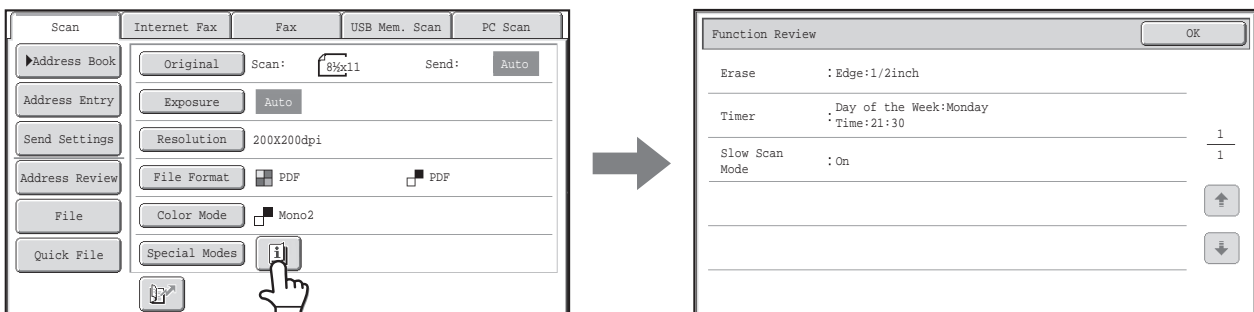

The special mode settings cannot be changed from the review screen. To change a setting, touch the [OK] key to close the review screen and then touch the [Special Modes] key and select the setting that you wish to change.

# ADDRESS BOOK SCREEN

This screen is used to select transmission destinations.

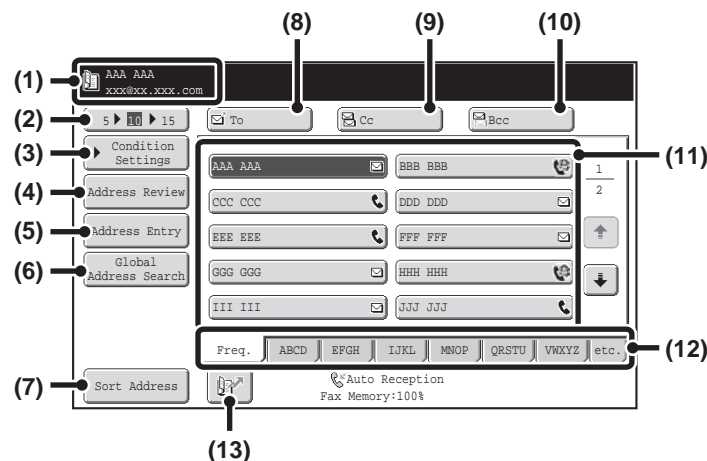

- (1) **This shows the selected destination.**
- (2) **Number of displayed items selector key**  
Touch this key to change the number of destinations (one-touch keys) displayed in the address book screen. Select 5, 10, or 15 keys.
- (3) **[Condition Settings] key**  
Touch this key to select transmission settings. When the key is touched, the base screen appears.  
➤ [BASE SCREEN](#) (page 5-9)
- (4) **[Address Review] key**  
Touch this key to view a list of the selected destinations. Destination selections can be changed.  
➤ [CHECKING AND DELETING THE SELECTED DESTINATIONS](#) (page 5-20)
- (5) **[Address Entry] key**  
Touch this key to manually enter a destination address instead of using a one-touch key.  
➤ [ENTERING AN ADDRESS MANUALLY](#) (page 5-22)
- (6) **[Global Address Search] key**  
When the use of a LDAP server has been enabled in the machine's Web pages, a transmission address can be obtained from a global address book.  
➤ [RETRIEVING A DESTINATION FROM A GLOBAL ADDRESS BOOK](#) (page 5-25)
- (7) **[Sort Address] key**  
Touch this key to change the index tabs to custom indexes or to display one-touch keys by send mode.  
➤ [CHANGING THE DISPLAY OF ONE-TOUCH KEYS IN THE ADDRESS BOOK SCREEN](#) (page 5-14)
- (8) **[To] key**  
Touch this key to enter the selected destination (one-touch key).  
➤ [RETRIEVING A DESTINATION](#) (page 5-19)
- (9) **[Cc] key**  
When using Scan to E-mail, touch the [Cc] key when you wish to send a "Carbon copy" of the e-mail to an additional destination.
- (10) **[Bcc] key**  
When using Scan to E-mail, touch the [Bcc] key when you wish to send a "Blind carbon copy" of the e-mail to an additional destination.  
When an address is specified as a Bcc recipient, other recipients will not know that the address is a recipient. This key only appears when Bcc has been enabled using "Bcc Setting" in the system settings (administrator).
- (11) **One-touch key display**  
The destinations (one-touch keys) stored in each index are displayed. This chapter refers to keys in which destinations and groups are stored as one-touch keys.  
➤ [RETRIEVING A DESTINATION](#) (page 5-19)
- (12) **Index tabs**  
Touch this to change the displayed index tab.  
➤ [Index display](#) (page 5-15)
- (13) **Search key**  
Touch this key to specify a destination using a search number\*.  
\* A 3-digit number assigned to a one-touch key or group key when it is stored.  
➤ [USING A SEARCH NUMBER TO RETRIEVE A DESTINATION](#) (page 5-21)

- Icons appear in the one-touch keys in the address book to indicate which mode is used for transmission.
  - [RETRIEVING A DESTINATION FROM THE ADDRESS BOOK](#) (page 5-18)
- For information on storing addresses in the address book, see "[STORING DESTINATION ADDRESSES FOR EACH SCAN MODE IN THE ADDRESS BOOK](#)" (page 5-6).
- For information on storing destinations for Scan to Desktop, see "[STORING A DESTINATION FOR SCAN TO DESKTOP](#)" (page 5-7).

- **System Settings: Address Book** (page 7-17)  
This is used to store Scan to E-mail and Internet fax addresses in one-touch keys.
- **System Settings (Administrator): The Number of Direct Address Keys Displayed Setting**  
This is used to change the default setting for the number of one-touch keys displayed in the address book screen.
- **System Settings (Administrator): Bcc Setting**  
This setting enables or disables Bcc delivery. When enabled, the [Bcc] key appears in the address book screen.
- **System Settings (Administrator): Default Display Settings**  
One of the following screens can be selected for the initial screen that appears when the [IMAGE SEND] key is touched.
  - Base screen of each mode (scan, Internet fax, fax, or data entry mode)
  - Address book screen
- **System Settings (Administrator): Address Book Default Selection**  
The following settings are available for the method of sorting the addresses that appear in the address book.
  - Index type (alphabetical, custom)
  - Address type (all, group, E-mail, FTP/Desktop, Network Folder, Internet fax, fax)

## CHANGING THE DISPLAY OF ONE-TOUCH KEYS IN THE ADDRESS BOOK SCREEN

You can show destinations of only a specific transmission mode in the address book screen, or change the displayed index tabs from the alphabetical tabs to the custom tabs. The procedure for selecting destinations does not change.

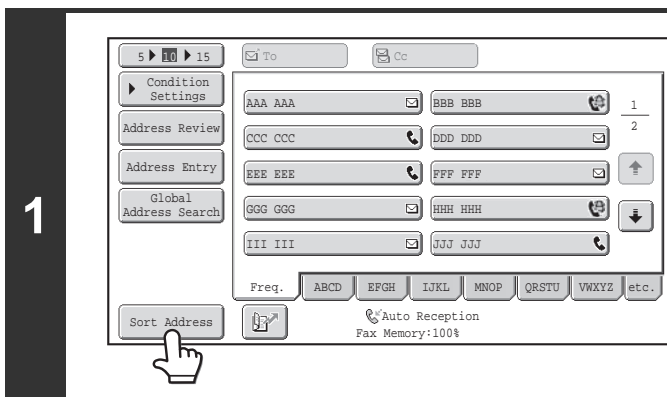

Touch the [Sort Address] key.

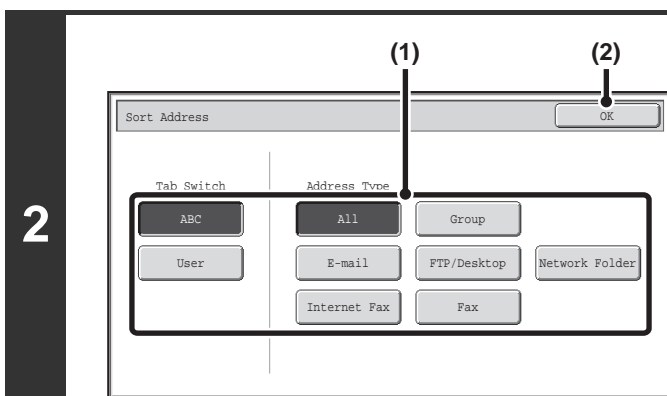

Change the display mode.

(1) Touch the key of the mode or tab that you wish to display.

- To show only the one-touch keys of a particular send mode, touch the desired mode key under "Address Type".
- To change the index tabs to the custom indexes, touch the [User] key under "Tab Switch".

(2) Touch the [OK] key.

## Index display

Indexes make it easy to search for a destination (one-touch key). The destinations are displayed separately using alphabetical search characters and index numbers. To display a stored destination, touch the appropriate index tab. It is convenient to store frequently used destinations in the [Freq.] index. Specify that a destination be displayed in the [Freq.] index when you store the destination.

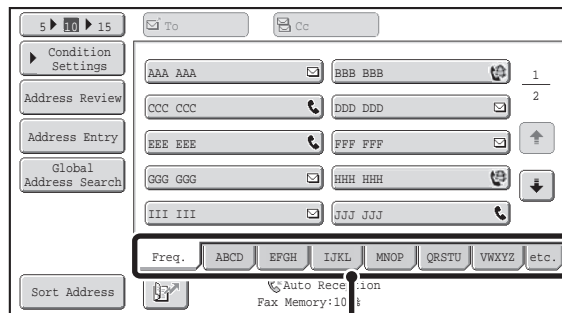

Index tabs

The destinations can also be displayed in alphabetical order by initial. Each time the displayed index tab is touched, the display order changes in the following order: search numbers (page 5-21), ascending names, descending names. When the display order is changed, the display order of the other index tabs also changes.

Ordered by search number (default)



Ascending names



Descending names



Index names can be changed using "Custom Index" in the system settings, allowing you to create groups of one-touch keys that can be easily recognized.



### System Settings: Custom Index (page 7-22)

This setting is used to store custom index names. The custom index where a one-touch key appears is specified when the transmission destination is stored in the key.

## Narrowing the search letter range

An alphabet tab on an index tab can be touched to display keys to further narrow the search range. For example, when the [ABCD] tab is touched, keys from "A" to "D" appear. If the [B] key is touched, only destinations starting with the letter "B" will appear. To cancel, touch the key again. Note that the search letter range cannot be narrowed on the [Freq.] tab, the [etc.] tab, or on a user index tab.

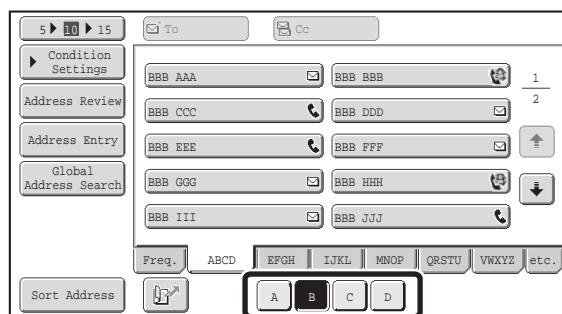

# SCAN SEND SEQUENCE

This section explains the basic procedure for scanning and transmission. Select settings in the order shown below to ensure smooth transmission.

For the detailed procedures for selecting the settings, see the explanation of each setting in this chapter.

## Place the original

Place the original in the document feeder tray of the automatic document feeder, or on the document glass.

- ☞ [PLACING THE ORIGINAL](#) (page 1-37)
- ☞ [SENDING AN IMAGE IN SCAN MODE](#) (page 5-28)
- ☞ [SENDING AN IMAGE IN USB MEMORY MODE](#) (page 5-36)
- ☞ [SENDING A FAX IN INTERNET FAX MODE](#) (page 5-42)



## Enter the destination

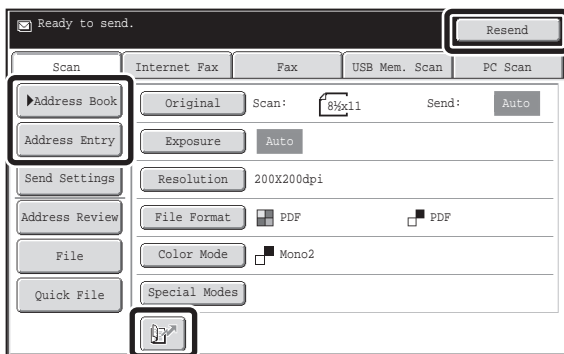

Specify the destination of the scan transmission.

- [Address Book] key:
  - ☞ [RETRIEVING A DESTINATION FROM THE ADDRESS BOOK](#) (page 5-18)
  - ☞ [RETRIEVING A DESTINATION FROM A GLOBAL ADDRESS BOOK](#) (page 5-25)
- [Address Entry] key:
  - ☞ [ENTERING AN ADDRESS MANUALLY](#) (page 5-22)
- [File] key:
  - ☞ [USING A SEARCH NUMBER TO RETRIEVE A DESTINATION](#) (page 5-21)
- [Resend] key:
  - ☞ [USING THE RESEND FUNCTION](#) (page 5-27)



## Select settings

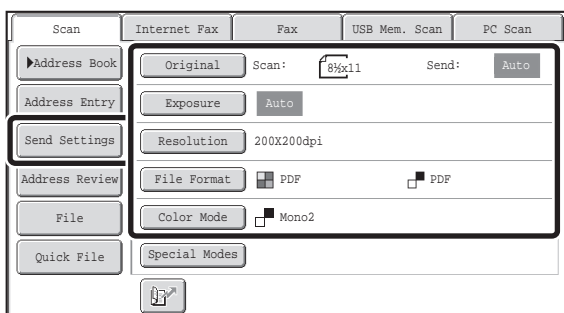

Settings can be selected for scanning the original.

- Original (2-sided original, scan size, send size)
- Exposure • Resolution • File Format • Color Mode
  - ☞ [IMAGE SETTINGS](#) (page 5-54)
- Send Settings (File Name)
  - ☞ [CHANGING THE SUBJECT, FILE NAME, REPLY-TO, AND BODY TEXT](#) (page 5-33)
- Scan mode, Data entry mode:
  - ☞ [CHANGING THE SUBJECT, FILE NAME, REPLY-TO, AND BODY TEXT](#) (page 5-33)
- USB memory mode:
  - ☞ [ENTERING A FILE NAME](#) (page 5-41)
- Internet fax mode:
  - ☞ [CHANGING THE SUBJECT, FILE NAME, AND BODY TEXT](#) (page 5-45)



## Special mode settings

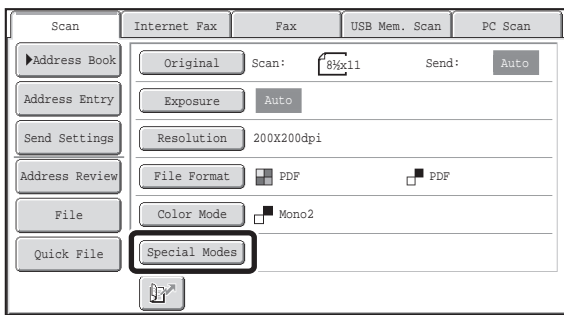

Special modes can be selected.

**SPECIAL MODES** (page 5-74)



## Start scanning and transmission

Start scanning and transmission.

If the original is placed on the document glass, follow these steps to start scanning and transmission:

- (1) Press the [START] key.
- (2) When scanning is finished, replace the original with the next original.
- (3) Press the [START] key.
- (4) Repeat (2) and (3) until all originals have been scanned.
- (5) Touch the [Read-End] key.



After the original is scanned, the settings revert to the default settings.



### To cancel scanning...

Press the [STOP] key ( ) to cancel the operation.



### System Settings (Administrator): Default Display Settings

The settings can be kept in effect a fixed period of time after scanning is completed.

# ENTERING DESTINATIONS





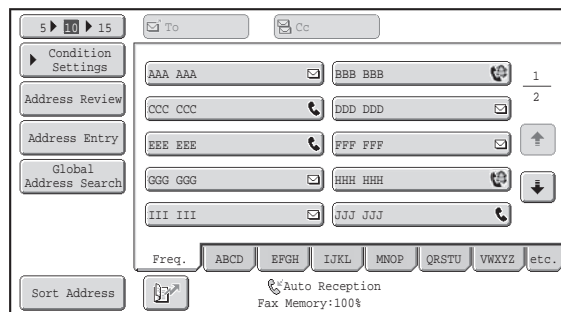

This section explains how to specify destination addresses, including selecting an address from the address book and retrieving an address by entering a search number.



## RETRIEVING A DESTINATION FROM THE ADDRESS BOOK

The address book screen shows stored destinations as one-touch keys. The destinations are displayed in order by search number.



The address book screen shows the destinations of all modes of the image send function. Each one-touch key shows the name of the destination and an icon indicating the mode to be used.

Icon	Mode
	Fax
	Scan to E-mail
	Internet fax (Direct SMTP)
	Scan to FTP
	Scan to Network Folder
	Scan to Desktop
	Group key with multiple destinations

-  For information on storing addresses in the address book, see "[STORING DESTINATION ADDRESSES FOR EACH SCAN MODE IN THE ADDRESS BOOK](#)" (page 5-6).
-  For information on storing destinations for Scan to Desktop, see "[STORING A DESTINATION FOR SCAN TO DESKTOP](#)" (page 5-7).

 **System Settings: Address Book (page 7-17)**  
This is used to store Scan to E-mail and Internet fax addresses in one-touch keys.

# RETRIEVING A DESTINATION

A destination is retrieved by selecting its one-touch key.

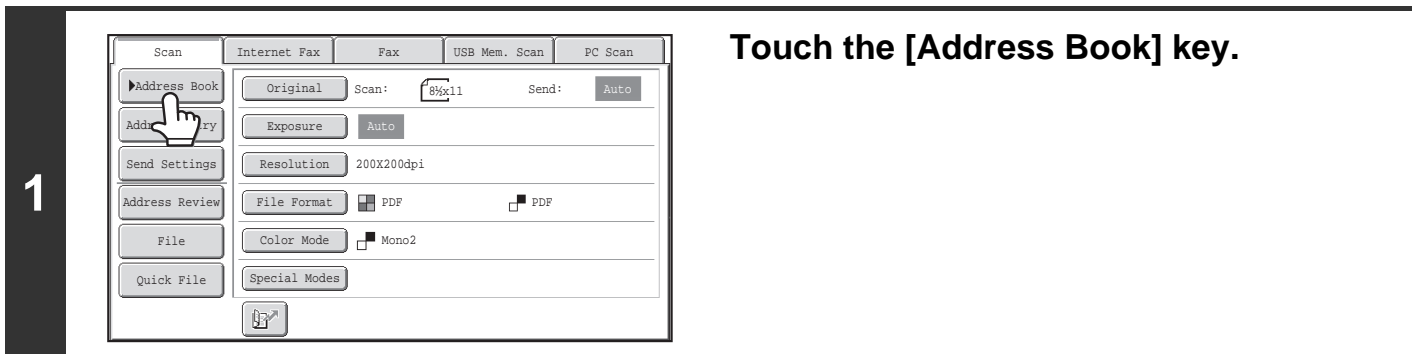

Touch the [Address Book] key.

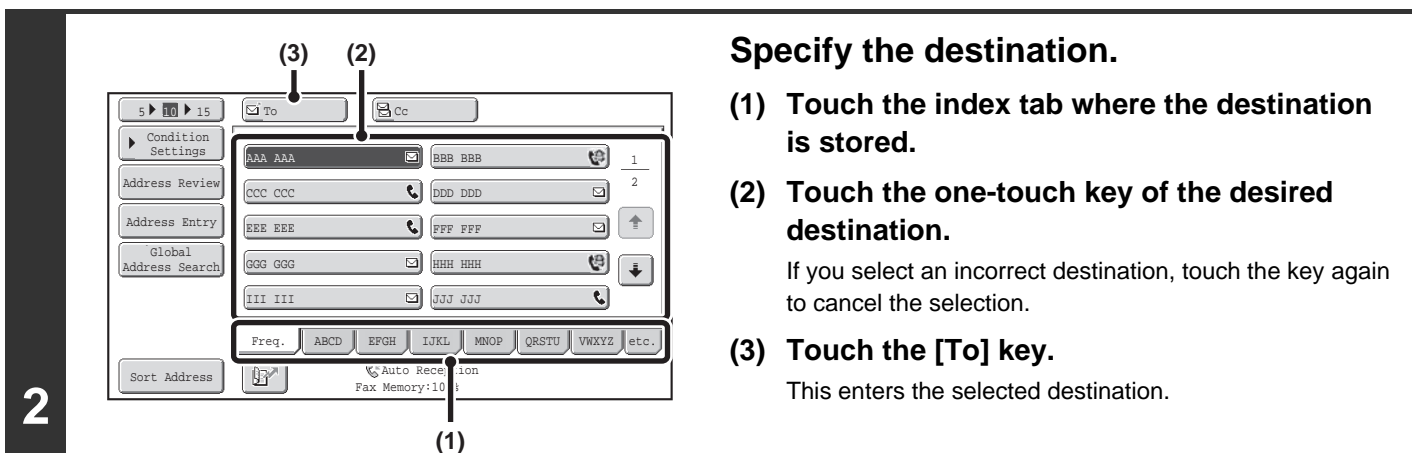

Specify the destination.

(1) Touch the index tab where the destination is stored.

(2) Touch the one-touch key of the desired destination.

If you select an incorrect destination, touch the key again to cancel the selection.

(3) Touch the [To] key.

This enters the selected destination.



- It is convenient to store frequently used destinations in the [Freq.] index. Specify that a destination be displayed in the [Freq.] index when you store the destination.

- To continue specifying other destinations...**

It is possible to specify multiple scan mode (Scan to E-mail, Scan to FTP, Scan to Desktop, Scan to Network Folder), Internet fax, and fax mode destinations when performing a broadcast transmission (maximum of 500 destinations). To specify multiple destinations, repeat (1) through (3) of this step.

When performing Scan to E-mail, you can select a one-touch key and then touch the [Cc] key or the [Bcc] key to send Cc or Bcc copies of the e-mail.



- System Settings (Administrator): Bcc Setting**

This setting enables or disables Bcc delivery. When enabled, the [Bcc] key appears in the address book screen.

- System Settings (Administrator): Must Input Next Address Key at Broadcast Setting**

This setting determines whether or not the [Next Address] key can be omitted before specifying the next destination. Factory default setting: the [Next Address] key can be omitted.

- System Settings (Administrator): Disable Switching of Display Order**

This is used to disable switching of the order of display of the one-touch keys in the address book screen. The currently selected display order will be the order that is used after this setting is enabled.



# CHECKING AND DELETING THE SELECTED DESTINATIONS

When multiple destinations have been selected, you can display and check the destinations. You can also delete a destination from the list (cancel selection of the destination).

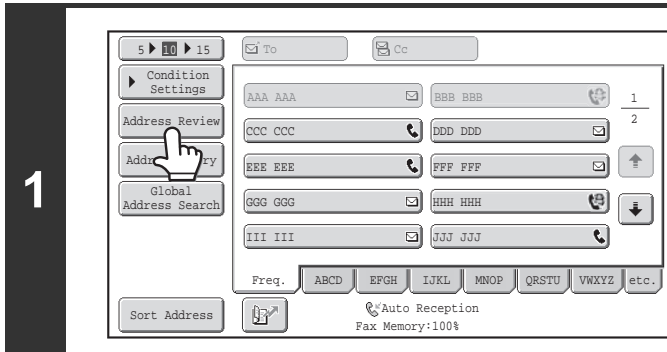

Touch the [Address Review] key.

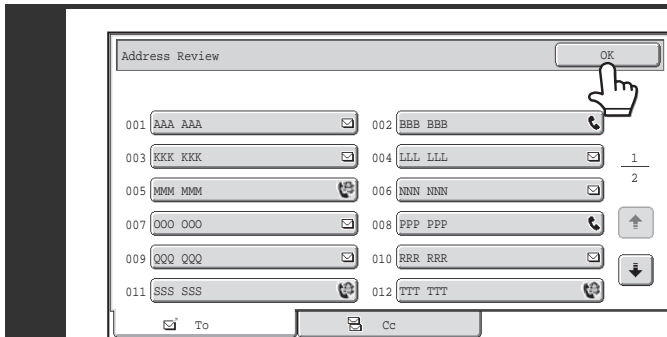

Check the destinations and then touch the [OK] key.

**2** To check Cc or Bcc destinations, touch the corresponding tab.

**To cancel selection of a destination...**  
Touch the one-touch key of the destination that you wish to cancel. A message will appear to confirm the deletion. Touch the [Yes] key. Touch the [Detail] key to check the specified destination type and name.

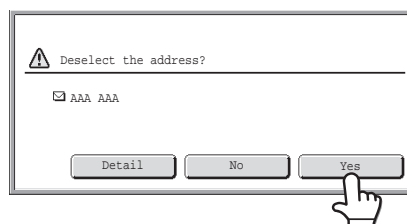

# USING A SEARCH NUMBER TO RETRIEVE A DESTINATION

A destination stored in the address book can be retrieved using the  key. This can be done in the base screen of any of the modes or in the address book screen.

Scan
Internet Fax
Fax
USB Mem. Scan
PC Scan

▶Address Book

Address Entry

Send Settings

Address Review

File

Quick File

Original Scan: 8% Send: Auto

Exposure Auto

Resolution 200X200dpi

File Format  PDF  PDF

Color Mode  Mono2

Special Modes



**Touch the  key.**



1	2	3
4	5	6
7	8	9
* (X)	0	#/P

**Enter the 3-digit search number of the address with the numeric keys.**

When the 3-digit search number is entered, the stored address is retrieved and specified as a destination.

---

2

-  • The search number is programmed when the destination is stored in the address book.
- If you do not know the search number, print the one-touch address list using "Sending Address List" in the system settings.
- When entering search numbers such as "001" and "011", "0" can be omitted. For example to enter "001", enter "1" and touch the  key or the [Next Address] key.

** If an incorrect search number is entered...**

Press the [CLEAR] key (C) to clear the number and enter the correct number.

# ENTERING AN ADDRESS MANUALLY

Scan to E-mail, Internet fax and data entry mode addresses can be manually entered.

1

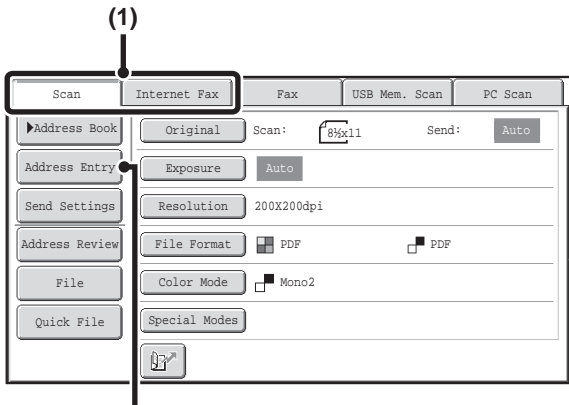

**Display the address input screen.**

(1) Touch the tab of the mode that you wish to use.

(2) Touch the [Address Entry] key.

2

**Scan mode**

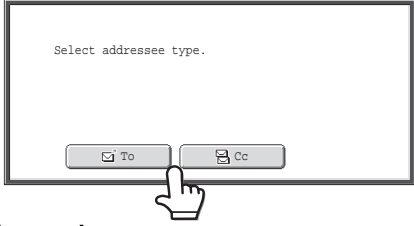

**Internet fax mode**

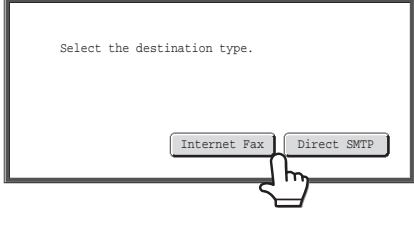

**Enter the destination address.**

(1) If you are in scan mode, touch the key of the desired delivery method.

- Normally the [To] key is touched. This specifies that the entered e-mail address will be a recipient.
- If Internet fax mode is selected, touch the [Internet Fax] key or the [Direct SMTP] key.

(2) Enter the destination address in the text entry screen that appears.

Enter the destination address and touch the [OK] key. For the procedure for entering text, see "[ENTERING TEXT](#)" (page 1-76) in "1. BEFORE USING THE MACHINE".

- If you wish the destination to be a Cc destination, touch the [Cc] key.
- The [Bcc] key only appears when Bcc has been enabled using "Bcc Setting" in the system settings (administrator). If you wish the destination to be a Bcc destination, touch the [Bcc] key.
- When Internet fax mode is selected, the base screen appears after the destination address is entered. However, if "I-Fax Reception Report On/Off Setting" is enabled in the system settings (administrator), the reception report request screen will appear. If you wish to receive a report, touch the [Yes] key. If not, touch the [No] key. (When Direct SMTP is used, transmission confirmation is not performed.)

- **System Settings (Administrator): I-Fax Reception Report On/Off Setting**  
This setting is used to request a reception report when an Internet fax is sent. When the destination is specified by directly entering the address, a message will appear asking you if you wish to receive a report. (When Direct SMTP is used, transmission confirmation is not performed.)
- **System Settings (Administrator): Bcc Setting**  
This setting enables or disables Bcc delivery. When enabled, the [Bcc] key appears in the address book screen and the delivery type selection screen.

# SPECIFYING A NETWORK FOLDER

A network folder on a server or computer connected to the same network as the machine can be directly specified. Select [Direct SMTP] in step 2 on the previous page and follow the steps below.

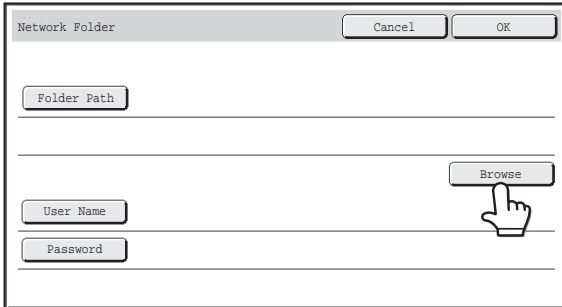
**1**

## Touch the [Browse] key.

- To directly enter a folder, touch the [Folder Path] key. A text entry screen will appear.
- If a user name and password are required, check with the administrator of the server and enter the user name and password.



For the procedure for entering text, see "ENTERING TEXT" (page 1-76) in "1. BEFORE USING THE MACHINE".

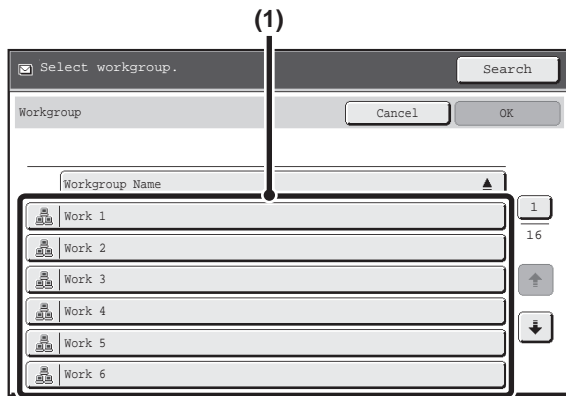

## Access the network folder.

- (1) Touch the key of the workgroup that you wish to access.

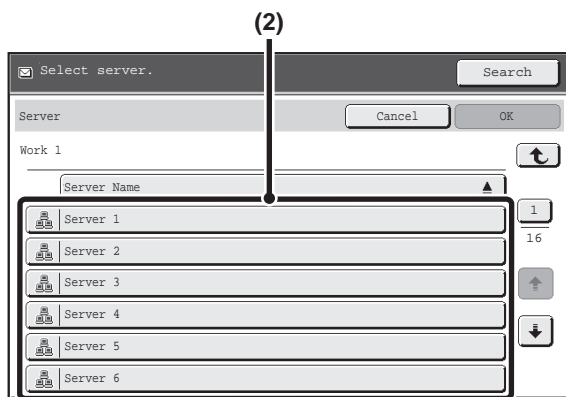

- (2) Touch the key of the server or computer that you wish to access.

If a screen appears prompting you to enter a user name and password, check with your server administrator and enter the appropriate user name and password.

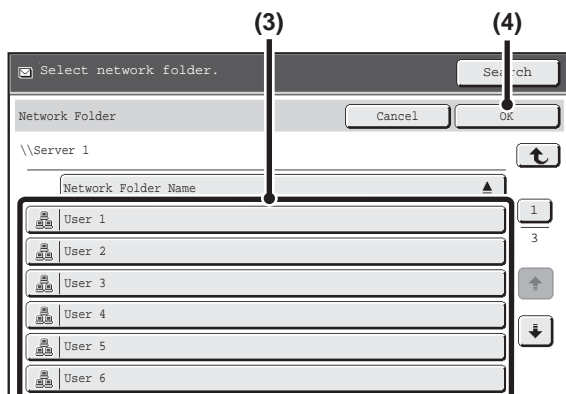





- (3) Touch the key of the network folder.

- (4) Touch the [OK] key.

You will return to the screen of step 1. Touch the [OK] key again to enter the folder.



- You can touch the [Search] key and enter a keyword to search for a workgroup, server, or network folder. For the procedure for entering text, see "ENTERING TEXT" (page 1-76) in "1. BEFORE USING THE MACHINE".
- Up to 100 workgroups, 100 servers, and 100 network folders can be displayed.
- To move up one level, touch the  key.
- The [Cancel] key can be pressed to return to the screen of step 1.
- To change the sorting order of the displayed keys, touch the key that shows  or  in each screen. The order switches between ascending order and descending order each time you touch the key.
- To go to a particular page, touch the  key that shows the current page number and enter the desired page number.

# RETRIEVING A DESTINATION FROM A GLOBAL ADDRESS BOOK

When a LDAP server is configured in the Web pages, you can look up an address in a global address book and retrieve the address for Scan to E-mail or Internet fax transmission (excluding Direct SMTP addresses).

1

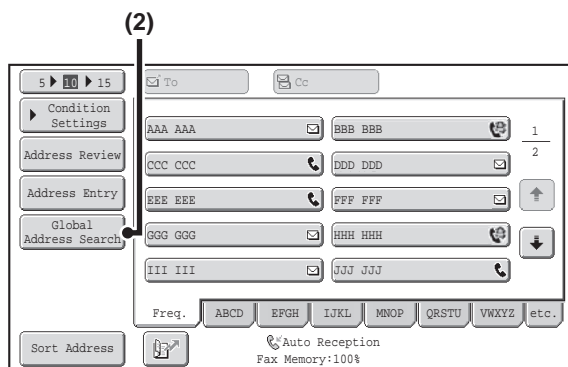

## Open the global address search screen.

### (1) Touch the [Address Book] key in the base screen.

For the [Address Book] key, see "BASE SCREEN" (page 5-9).

### (2) Touch the [Global Address Search] key.

2

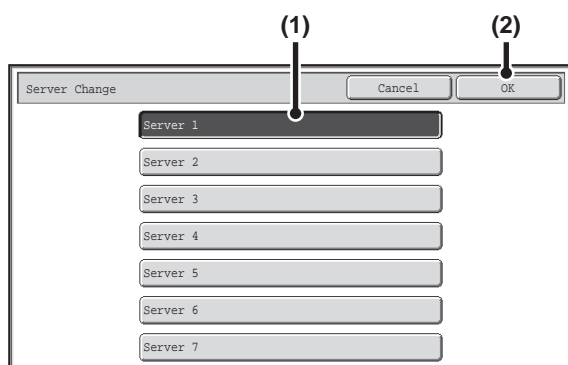

## Search for the destination.

If only one LDAP server has been stored, (1) and (2) are not necessary. Go directly to (3). If an authentication screen for the LDAP server appears, enter your user name and password.

### (1) Touch the key of the LDAP server that you wish to use.

If an authentication screen for the LDAP server appears, enter your user name and password.

### (2) Touch the [OK] key.

### (3) Search for the destination in the search screen.

Enter search characters for the destination and touch the [Search] key. The search results will appear after a brief interval.

For the procedure for entering text, see "ENTERING TEXT" (page 1-76) in "1. BEFORE USING THE MACHINE".



#### How to search

Enter the search characters (maximum of 64 characters). The system will look for names starting with the entered letters.

An asterisk \* can be used as follows:

XXX\*: Names beginning with "XXX".

\*XXX: Names that end with "XXX".

\*XXX\*: Names that include "XXX".

AA\*XX: Names that start with "AA" and end with "XX".

3

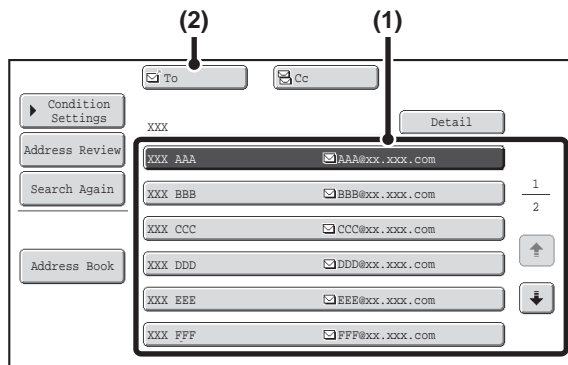

## Select the destination.

### (1) Touch the key of the desired destination.

If no names are found that match the search characters, a message will appear. Touch the [OK] key to close the message and touch the [Search Again] key to search again.

### (2) Touch the [To] key.

This enters the selected destination.

If you wish to enter another destination, repeat (1) and (2) of this step.



- If 30 or more matches are found, a message will appear in the screen. Touch the [OK] key to close the message. Up to 300 matches can appear. If no names are found that match the search letters, touch the [Search Again] key to search again using more search letters.
- **To check the information stored in a destination...**  
Touch the key of the destination and then touch the [Detail] key. The information stored for the selected destination will appear. Check the information and then touch the [OK] key to return to the search results screen.
- **If a screen for selecting the item to be used appears...**  
If the selected destination includes a fax number, telephone number, or other contact information in addition to the e-mail address or Internet fax address, you will need to select which item you wish to use. Touch the [E-mail] key or the [Internet Fax] key to retrieve the address for Scan to E-mail or Internet fax transmission.

## Storing a destination from a global address book in the machine's address book

A destination address obtained from a global address book can be stored as a destination (one-touch key) in the address book of the machine.

Touch the [Detail] key in the search results screen of the global address book (the screen of step 3 above) to display information on the selected destination. Touch the [Register] key in the detailed information screen and then touch the item to be used (the [E-mail] key or the [Internet Fax] key). The following screens will appear.

### E-mail address registration screen

Direct Address / Individual		Exit
<input checked="" type="checkbox"/> E-mail	<input type="checkbox"/> Internet Fax	<input type="checkbox"/> Fax
Search Number	001	
Name	AAA AAA	
Initial	A	Index User 1
Address	AAA@xx.xxx.com	
Key Name	AAA AAA	
File Format	Color/Grayscale : PDF/Medium	
	B/W	: PDF/MMR(G4)

### Internet fax address registration screen

Direct Address / Individual		Exit
<input type="checkbox"/> E-mail	<input checked="" type="checkbox"/> Internet Fax	<input type="checkbox"/> Fax
Search Number	001	
Name	AAA AAA	
Initial	A	Index User 1
Address	AAA@xx.xxx.com	
Key Name	AAA AAA	
Compression	MH (G3)	
I-Fax Report	Off	

The information stored in the global address book is automatically entered. (The settings can be changed if needed. For detailed information on each item, see "Address Control" (page 7-17) in "7. SYSTEM SETTINGS".) However, configure the items below manually. To complete the storing procedure, touch the [Exit] key.

- [Initial] key: Touch this key to enter the initials that determine where the destination will appear in the alphabetical index and the order of one-touch key display. Enter up to 10 characters for the initials.
- [Index] key: Touch this key to select the custom index in which the address will appear. You can also select whether or not the destination will be included on the [Freq.] tab of the address book.
- [File Format] key: Set the format for Scan to E-mail. Default format settings have already been configured; however, selecting format settings when you store a destination saves you the trouble of selecting the settings each time you transmit to that destination.
- [Compression] key: Touch this key to set the compression mode when sending an Internet fax.
- [I-Fax Report] key: Touch this key to request a reception report when sending an Internet fax.

# USING THE RESEND FUNCTION

The destinations of the most recent 8 transmissions by Scan to E-mail, Internet fax (including Direct SMTP addresses) and/or fax are stored. One of these can be selected to resend to that destination.

1

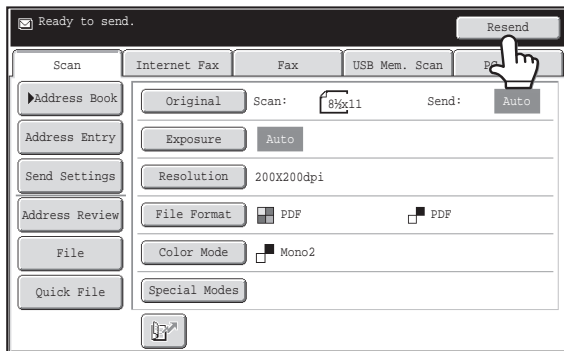

Touch the [Resend] key.

2

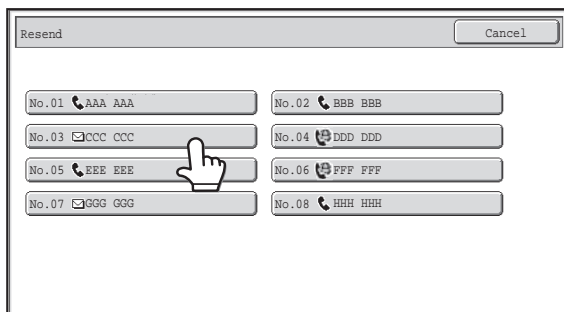

Touch the key of the desired address.

The last 8 addresses used for transmission are displayed.



- When the [Resend] key is touched and a destination selected, the mode of the selected destination is automatically selected.
- The following types of addresses are not stored for resending.
  - A one-touch key in which multiple destinations are stored (group key).
  - Scan to FTP, Scan to Desktop, and Scan to Network Folder addresses.
  - Broadcasting destinations
  - Addresses used only for BCC delivery
  - Destinations transmitted to using a program



#### System Settings (Administrator): Disable [Resend] on Fax/Image Send Mode

This prohibits use of the resend function. When this setting is enabled, the [Resend] key cannot be used in the base screen of image send mode.



# TRANSMITTING AN IMAGE

---

---

## SENDING AN IMAGE IN SCAN MODE

This section explains the basic procedure for transmission in scan mode (Scan to E-mail, Scan to FTP, Scan to Desktop, and Scan to Network Folder).



When a default address is configured in "Default Address Setting" in the system settings (administrator), the mode cannot be changed, the destination cannot be changed, and destinations cannot be added. If you wish to change the mode or destination, touch the [Cancel] key in the touch panel and then follow the procedure below.

# Place the original.

[PLACING THE ORIGINAL](#) (page 1-37)

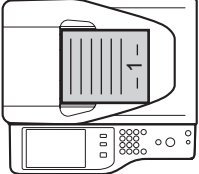
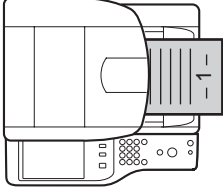
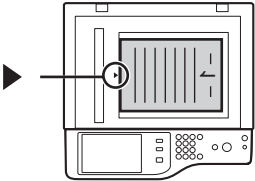
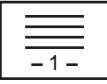
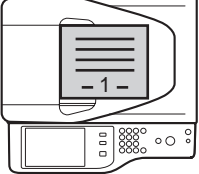
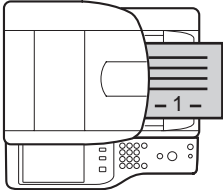
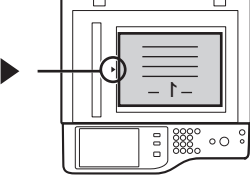

- When placing the originals, orient them as shown below.

<p><b>Originals</b></p>	<p><b>Document feeder tray</b> Place the original face up.</p>	<p><b>Document glass</b> Place the original face down with the middle aligned with the tip of the ► mark at the middle of the scale on the left side of the document glass.</p>
<p>Portrait orientation*</p> 	<p><b>MX-B402</b></p>  <p><b>MX-B402SC</b></p> 	
<p>Landscape orientation</p> 	<p><b>MX-B402</b></p>  <p><b>MX-B402SC</b></p> 	

\* To place a large portrait-oriented original, place it as shown above in "Landscape orientation" and specify the placement orientation in step 3.

- Originals cannot be scanned in succession from both the automatic document feeder and the document glass and sent in a single transmission.

2

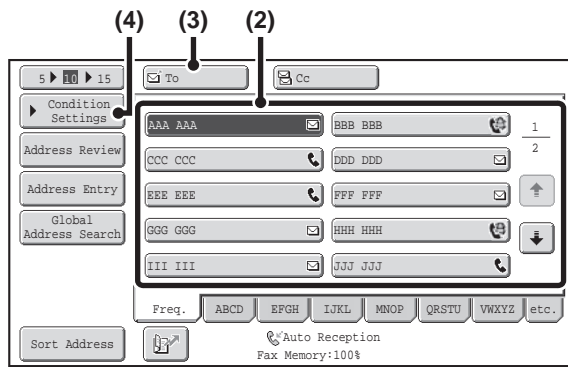

### Specify the destination.

(1) Touch the [Address Book] key in the base screen.

For the [Address Book] key, see "BASE SCREEN" (page 5-9).

(2) Touch the one-touch key of the desired destination.

The icon on the key indicates the type of destination stored in the key.

- : Scan to E-mail
- : Scan to FTP
- : Scan to Network Folder
- : Scan to Desktop

(3) Touch the [To] key.

The destination is specified.

(4) Touch the [Condition Settings] key.



- After a one-touch key is touched, if the screen is changed without touching the [To] key, the destination is automatically specified.
- When performing Scan to E-mail, you can also send Cc or Bcc copies to other destinations. Touch the desired destination and then touch the [Cc] key or the [Bcc] key.
- Multiple destinations can be specified. To specify multiple destinations, repeat steps (2) and (3).
- You can also select multiple one-touch keys and then touch the [To] key (or the [Cc] or [Bcc] key) to specify all selected keys at once.
- In addition to specification by a one-touch key, a destination can also be specified by a search number. For a Scan to E-mail destination, you can enter an address manually or retrieve an address from a global address book. For more information, see "ENTERING DESTINATIONS" (page 5-18).



#### System Settings (Administrator): Bcc Setting

This setting enables or disables Bcc delivery. When enabled, the [Bcc] key appears in the address book screen.

3

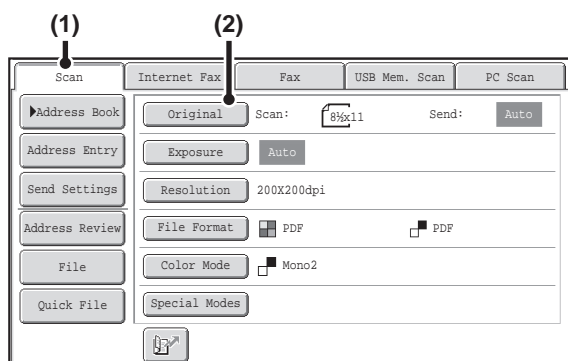

### Switch to scan mode and display the image settings screen.

(1) Touch the [Scan] tab.

(2) Touch the [Original] key.



The current settings for [Original], [Exposure], [Resolution], [File Format], and [Color Mode] are indicated at the right of each key. To change a setting, touch the appropriate key.

- **AUTOMATICALLY SCANNING BOTH SIDES OF AN ORIGINAL (2-Sided Original)** (page 5-55), **SPECIFYING THE ORIGINAL SCAN SIZE AND SEND SIZE** (page 5-56), **CHANGING THE EXPOSURE AND ORIGINAL IMAGE TYPE** (page 5-64), **CHANGING THE RESOLUTION** (page 5-66), **CHANGING THE FILE FORMAT** (page 5-67), **CHANGING THE COLOR MODE** (page 5-71), **SPECIAL MODES** (page 5-74)

4

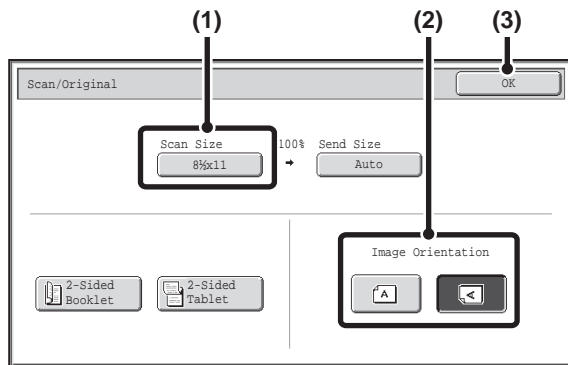

## Check the original scan size and placement orientation.

To make sure that the original is scanned in the correct orientation (the orientation in which the top edge of the original appears at the top of the display), check the size and orientation of the original placed in step 1.

### (1) Check the scan size.

Check if the size of the placed original is displayed. If the displayed size is different from the size of the placed original, set the original size.

☞ [SPECIFYING THE ORIGINAL SCAN SIZE AND SEND SIZE](#) (page 5-56)

### (2) Touch the appropriate orientation key.

If the top edge of the original is up, touch the key. If the top edge of the original is to the left, touch the key.

### (3) Touch the [OK] key.

You will return to the screen of step 2.



- The placement orientation of the original is initially set to . If you placed the original with the top edge to the left, this step is not necessary.
- The original size set in the system settings appears as the original size.

5

## Press the [START] key.

Scanning begins.

- If the original is placed on the document glass, the [Read-End] key appears in the touch panel. If the original is only one page, go to step 7. To scan more pages, go to the next step.
- If the original was inserted in the document feeder tray, a beep will sound when scanning is completed and transmission will take place.



- If the color mode is set to [Auto], the color used in the original is automatically detected and scanning takes place in full color, grayscale, or Mono2.
- If the file type is [Encrypt PDF], a password entry screen will appear when the [START] key is pressed.

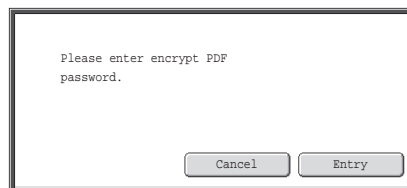

Touch the [Entry] key to open the keyboard screen, enter a password (maximum of 32 characters), and touch the [OK] key. The recipient must use the password entered here to open the encrypted PDF file.

To cancel encrypted PDF, touch the [Cancel] key. The format settings screen will appear to let you change the file type. Select a new file type and press the [START] key to begin transmission.

6

## If the original was placed on the document glass, replace it with the next original and press the [START] key.

Repeat until all originals have been scanned.

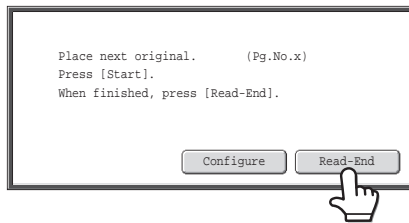

## Touch the [Read-End] key.

A beep will sound to indicate that the operation is completed. Open the automatic document feeder and remove the original.



- If no action is taken for one minute after the confirmation screen appears, scanning automatically ends and the transmission is reserved.
- The [Configure] key can be touched to change the exposure, resolution, scan size, and send size for each original page scanned. However, when "Card Shot" is selected in the special modes, only the exposure can be changed when scanning an even-numbered original page.



- When all originals have been scanned, "Job stored." will be displayed together with a job control number. This number can be used to locate the job in the Transaction Report or in the Image Sending Activity Report. If the job is a broadcast transmission, this number will also appear in the key of the job in the job status screen. For this reason, making a note of the number is useful for checking the result.
- If the memory becomes full while the originals are being scanned, a message will appear and scanning will stop.
- When performing Scan to E-mail, take care not to send a file that is too large. In particular, multi-page files tend to be large. When sending a multi-page file or other large file, it may be necessary to reduce the number of scanned pages or reduce the send size.
- **Storing a mail signature**  
You can have preset text automatically added at the end of e-mail messages as a mail signature. This is convenient when you wish to have a corporate policy or other preset text appear at the bottom of e-mail messages. To store the text for the mail signature, click [Application Settings], [Network Scanner Settings] and then [Administration Settings] in the Web page menu. (Administrator rights are required.) Up to 900 characters can be entered. (The mail signature is not included in the maximum number of characters that can be entered in the e-mail message.)  
Use "Pre-Setting Mail Signature" in the system settings (administrator) to specify whether or not a mail signature is added.



### To cancel scanning...

Press the [STOP] key (⏹) to cancel the operation.



- **System Settings (Administrator): Image Send Settings**  
Use this to configure scanner transmission settings, including the default resolution and exposure settings, the default color mode and file format, the file compression method for broadcasting, the file size limit for Scan to E-mail, and the default sender and destination.
- **System Settings (Administrator): Pre-Setting Mail Signature**  
Use this setting to specify whether or not a mail signature is added at the end of e-mail messages. By factory default, a mail signature is not added.

# CHANGING THE SUBJECT, FILE NAME, REPLY-TO, AND BODY TEXT

The subject, file name, reply-to, and body text can be changed when performing a scan transmission. Preset items can be selected or text can be directly entered.

- When performing Scan to FTP, Scan to Desktop, or Scan to Network Folder, only the file name is used.
- If the subject and file name are not changed, the settings in the Web page are used.
- If the sender name is not changed, the name set in "Default Sender Set" in the system settings is used. If this is not configured, the reply address in [Network Settings] - [Services Settings] - [SMTP Settings] in the Web pages is used. (Administrator rights are required.)
- Selections for the subject, file name, and body text are configured by clicking [Application Settings] and then [Network Scanner Settings] in the Web page menu.
- For the procedure for entering text, see "[ENTERING TEXT](#)" (page 1-76) in "1. BEFORE USING THE MACHINE".

- 1** Touch the [Send Settings] key in the base screen.  
 BASE SCREEN (page 5-9)  
 If you are sending to a Scan to FTP, Scan to Desktop, or Scan to Network Folder destination, go to step 4.

**2**

To change the subject, touch the [Subject] key.

**3**

Enter the subject.

- (1) Touch a Pre-Set text key.
- (2) Touch the [OK] key.

- If you wish to directly enter the text, touch the [Direct Entry] key to open the text entry screen. Enter the text and touch the [OK] key.
- The text in a pre-set text key can be edited by touching the pre-set text key and then the [Direct Entry] key. The text entry screen will appear with the selected pre-set text entered. (When a destination is stored using the Web pages, up to 80 characters can be entered. However, only 54 characters can be entered in the touch panel.)

4

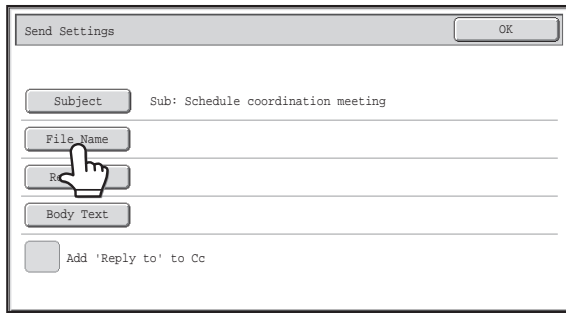

**To change the file name, touch the [File Name] key.**

- The file name is entered in the same way as the subject.
- If you are sending to a Scan to FTP, Scan to Desktop, or Scan to Network Folder destination, go to step 9.

5

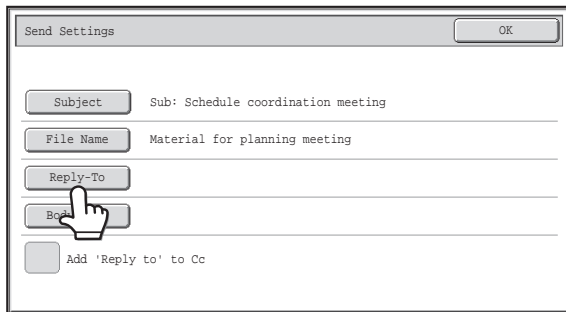

**To change "Reply-To", touch the [Reply-To] key.**



If user authentication is being used, the information of the user that logged in will be applied, and thus "Reply-To" cannot be changed.

6

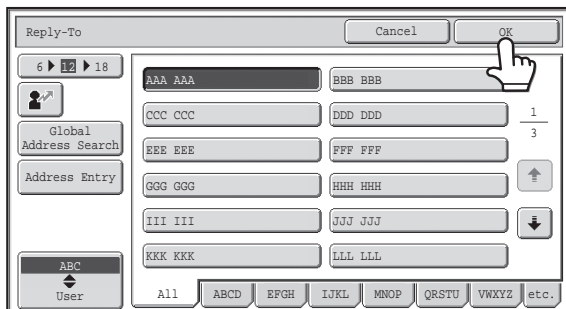

**Specify a user for "Reply-To" and touch the [OK] key.**

- Touch the key that you wish to use for "Reply-To".
- You can touch the [Global Address Search] key to specify a user stored in a global address book for "Reply-To". You can also touch the [Address Entry] key to directly enter an e-mail address.



- To specify the return address, you can touch the  key and enter a user number that has been previously stored using "User List" in the system settings (administrator).
- A key can only be selected for the return address if an e-mail address has been stored for that user in "User List" in the system settings (administrator).

7

Send Settings OK

Subject Sub: Schedule coordination meeting

File Name Material for planning meeting

Reply-To AAA AAA

Body Text

Add 'Reply to' to Cc

To change the body text, touch the [Body Text] key.

8

Body Entry Clear All OK

Thank you for your continuous support. We have attached scanned which you have requested.

Pre-Set Select Edit ▲ ▼

Enter the body text and touch the [OK] key.

- To select a pre-set text previously stored in the Web page, touch the [Pre-Set Select] key.
- To directly enter the body text, touch the [Edit] key.



- 1800 characters can be entered. (A line break counts as one character.)
- To clear all entered text, touch the [Clear All] key. When this key is touched, the entire body of the message is erased immediately; not just the selected line.
- Each line of the entered text can be selected with the ▼ ▲ keys. To edit the selected line, touch the [Edit] key. The text entry screen will appear with the selected text entered.

9

Send Settings OK

Subject Sub: Schedule coordination meeting

File Name Material for planning meeting

Reply-To AAA AAA

Body Text Thank you for your continuous support. We have attached sca

Add 'Reply to' to Cc

Touch the [OK] key.



The [Add 'Reply to' to Cc] checkbox can be selected  to send a Cc copy to the sender.



When storing pre-set text for the subject and file name in the Web pages, up to 80 characters can be entered.



- **System Settings (Administrator): The Number of File Name/Subject/Body Keys Displayed Setting**  
The setting for the number of subject keys and file name keys displayed in one screen can be changed to 6, 12, or 18.
- **System Settings (Administrator): Default Sender Set**  
This is used to store the sender name and e-mail address that is used when a sender is not selected.



---

---

# SENDING AN IMAGE IN USB MEMORY MODE

Follow the steps below to send a scanned image to a commercially available USB memory device that has been connected to the machine. This stores the file in the USB device.

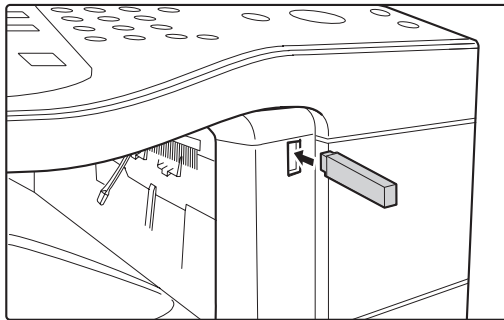

- Use a FAT32 USB memory with a capacity of no more than 32 GB.
- When a default address is configured in "Default Address Setting" in the system settings (administrator), the mode cannot be changed. To switch to USB memory mode, touch the [Cancel] key in the touch panel and then follow the steps below.

**1**



**Connect the USB memory to the USB connector (Type A) on the machine.**

## Place the original.

 **PLACING THE ORIGINAL** (page 1-37)

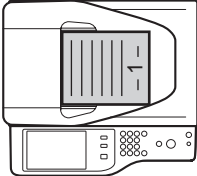
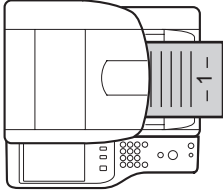
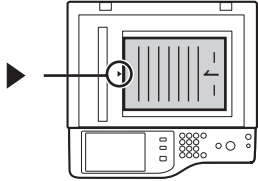

- When placing the originals, orient them as shown below.

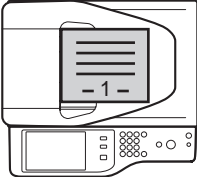
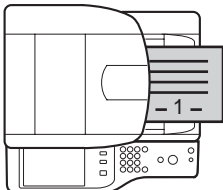
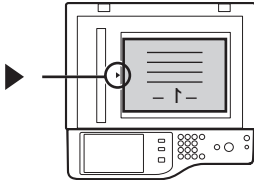
<p><b>Originals</b></p>	<p><b>Document feeder tray</b> Place the original face up.</p>	<p><b>Document glass</b> Place the original face down with the middle aligned with the tip of the ► mark at the middle of the scale on the left side of the document glass.</p>
<p>Portrait orientation*</p> 	<p><b>MX-B402</b></p>  <p><b>MX-B402SC</b></p> 	
<p>Landscape orientation</p> 	<p><b>MX-B402</b></p>  <p><b>MX-B402SC</b></p> 	

\* To place a large portrait-oriented original, place it as shown above in "Landscape orientation" and specify the placement orientation in step 4.

- Originals cannot be scanned in succession from both the automatic document feeder and the document glass and sent in a single transmission.

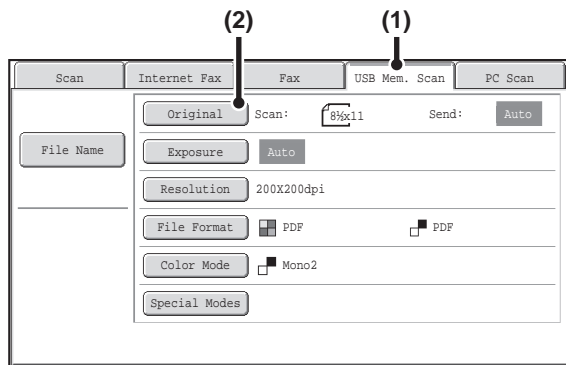

## Switch to USB memory mode and display the image settings screen.

### (1) Touch the [USB Mem. Scan] tab

If the [USB Mem. Scan] tab does not appear, touch the  tab to move the screen.

### (2) Touch the [Original] key.

3



- When scanning to USB memory, there is no need to specify the destination.
- If a destination of another mode has been previously specified, a message will appear when you change to USB memory mode indicating that the destination setting will be cleared. Touch the [OK] key in the message screen and go to the next step.
- The current settings for [Original], [Exposure], [Resolution], [File Format], and [Color Mode] are indicated at the right of each key. To change a setting, touch the appropriate key.
  - ✎ [AUTOMATICALLY SCANNING BOTH SIDES OF AN ORIGINAL \(2-Sided Original\)](#) (page 5-55), [SPECIFYING THE ORIGINAL SCAN SIZE AND SEND SIZE](#) (page 5-56), [CHANGING THE EXPOSURE AND ORIGINAL IMAGE TYPE](#) (page 5-64), [CHANGING THE RESOLUTION](#) (page 5-66), [CHANGING THE FILE FORMAT](#) (page 5-67), [CHANGING THE COLOR MODE](#) (page 5-71), [SPECIAL MODES](#) (page 5-74)

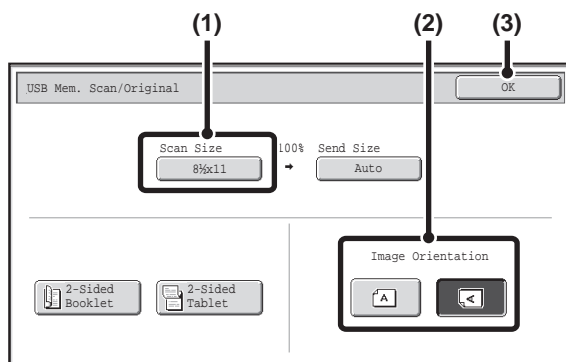

## Check the original scan size and placement orientation.



To make sure that the original is scanned in the correct orientation (the orientation in which the top edge of the original appears at the top of the display), check the size and orientation of the original placed in step 1.

### (1) Check the scan size.

Check if the size of the placed original is displayed. If the displayed size is different from the size of the placed original, set the original size.

✎ [SPECIFYING THE ORIGINAL SCAN SIZE AND SEND SIZE](#) (page 5-56)

### (2) Touch the appropriate orientation key.

If the top edge of the original is up, touch the  key. If the top edge of the original is to the left, touch the  key.

### (3) Touch the [OK] key.

You will return to the screen of step 3.

4



- The placement orientation of the original is initially set to . If you placed the original with the top edge to the left, this step is not necessary.
- The original size set in the system settings appears as the original size.

## Press the [START] key.

Scanning begins.

- If the original is placed on the document glass, the [Read-End] key appears in the touch panel. If the original is only one page, go to step 7. To scan more pages, go to the next step.
- If the original was inserted in the document feeder tray, a beep will sound when scanning is completed and transmission will begin. Go to step 8.

5



Do not disconnect the USB memory until "Sending data has been completed." appears in the touch panel.



- If the color mode is set to [Auto], the color used in the original is automatically detected and scanning takes place in full color, grayscale, or Mono2.
- If the file type is [Encrypt PDF], a password entry screen will appear when the [START] key is pressed.

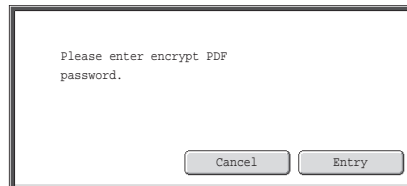

Touch the [Entry] key to open the keyboard screen, enter a password (maximum of 32 characters), and touch the [OK] key. The recipient must use the password entered here to open the encrypted PDF file.

To cancel encrypted PDF, touch the [Cancel] key. The format settings screen will appear to let you change the file type. Select a new file type and press the [START] key to begin transmission.

6

## If the original was placed on the document glass, replace it with the next original and press the [START] key.

Repeat until all originals have been scanned.

7

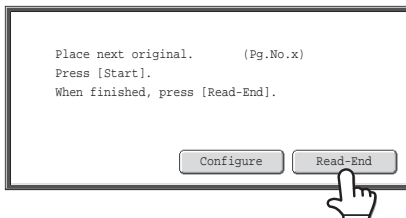

## Touch the [Read-End] key.

A beep will sound to indicate that the operation is completed. Open the automatic document feeder and remove the original.



- If no action is taken for one minute after the confirmation screen appears, scanning automatically ends and the transmission is reserved.
- The [Configure] key can be touched to change the exposure, resolution, scan size, and send size for each original page scanned. However, when "Card Shot" is selected in the special modes, only the exposure can be changed when scanning an even-numbered original page.

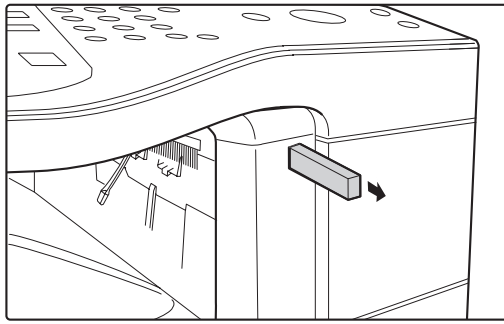

When "Sending data has been completed." appears in the touch panel, disconnect the USB memory.



Do not disconnect the USB memory while "Processing data." or "Sending data." appears in the touch panel.



- When transmission to USB memory is completed, "Sending data has been completed." is displayed. After a brief interval the message is cleared and the base screen of image send mode reappears. (The base screen of image send mode is the screen that appears when the [IMAGE SEND] key is touched.)
- **If the USB memory becomes full during scanning...**  
A message will appear and scanning will stop. The scanned data will not be stored. However, if the file format is set to JPEG and the [Specified Pages per File] checkbox is selected, files for which scanning is completed will be stored in USB memory.



- **To cancel scanning...**  
Press the [STOP] key (⏹) to cancel the operation.
- **To cancel scanning to USB memory...**  
While scanned data is being stored in the USB memory, the message "Sending data." and the [Cancel] key appear in the touch panel. To cancel the storing operation, touch the [Cancel] key.



- **System Settings: USB-Device Check (page 7-30)**  
This is used to check the connection of a USB device to the machine.
- **System Settings (Administrator): Scan Settings**  
This is used to set the default color mode and file format.
- **System Settings (Administrator): Disable Scan Function**  
The use of PC scan mode and USB memory mode can be prohibited.

## ENTERING A FILE NAME

The file name can be directly entered when performing a scan transmission.



- If the file name is not entered, the settings in the Web page are used.
- For the procedure for entering text, see "[ENTERING TEXT](#)" (page 1-76) in "1. BEFORE USING THE MACHINE".

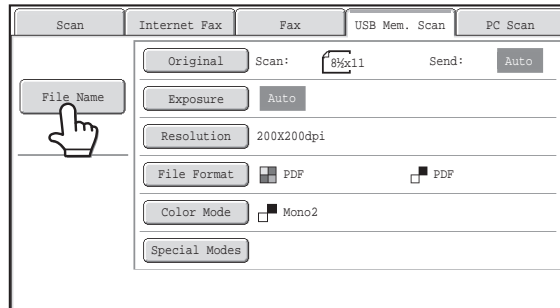

Touch the [File Name] key. A text entry screen will appear. Enter the file name and touch the [OK] key.



- To check the entered file name, touch the [File Name] key in the base screen once again.

# SENDING A FAX IN INTERNET FAX MODE

The basic procedure for sending a fax in Internet fax mode is explained below. This procedure can also be used to perform direct transmission by Direct SMTP.

 When a default address is configured in "Default Address Setting" in the system settings (administrator), the mode cannot be changed, the destination cannot be changed, and destinations cannot be added. To switch to Internet fax mode, touch the [Cancel] key in the touch panel and follow the steps below.

## Place the original.

Place the original face up in the document feeder tray, or face down on the document glass.

 [PLACING THE ORIGINAL](#) (page 1-37)

 • **Image rotation**  
5-1/2" x 8-1/2"(A5) or B5 size original in landscape orientation will be rotated 90 degrees and transmitted as an 5-1/2" x 8-1/2"(A5) or B5 image in portrait orientation.



- Originals cannot be scanned in succession from both the automatic document feeder and the document glass and sent in a single transmission.

### System Settings (Administrator): Rotation Sending Setting

This is used to select whether or not a scanned original image is rotated before transmission.

Initially a B5 landscape original is set to be rotated and sent as a B5 portrait image, and an 5-1/2" x 8-1/2" (A5) landscape original is set to be rotated and sent as an 5-1/2" x 8-1/2" (A5) portrait image.

1

## Specify the destination.

(1) Touch the [Address Book] key in the base screen.

For the [Address Book] key, see "[BASE SCREEN](#)" (page 5-9).

(2) Touch the key of the desired destination.

The  icon appears in one-touch keys in which Internet fax addresses are stored.

(3) Touch the [To] key.

The destination is specified.

(4) Touch the [Condition Settings] key.

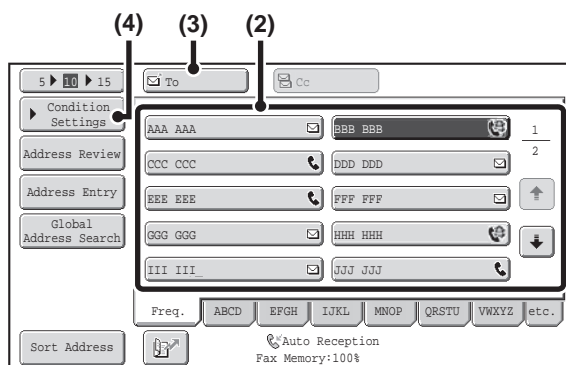

2

- After a one-touch key is touched, if the screen is changed without touching the [To] key, the destination is automatically specified.
- In addition to specification by a one-touch key, a destination can also be specified by a search number. You can also manually enter a destination or look up a destination in a global address book. For more information, see "[ENTERING DESTINATIONS](#)" (page 5-18).

3

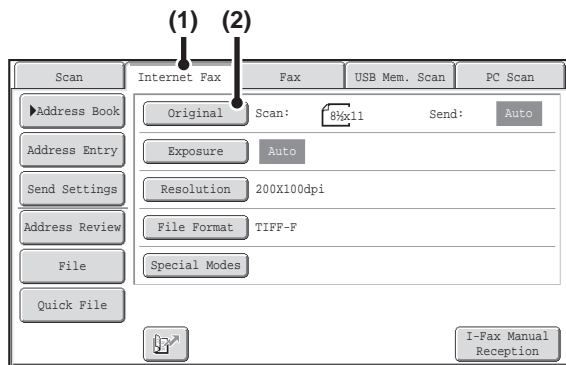

Switch to Internet fax mode and display the image settings screen.

- (1) Touch the [Internet Fax] tab.
- (2) Touch the [Original] key.



The current settings for [Original], [Exposure], [Resolution], and [File Format] are indicated at the right of each key. To change a setting, touch the appropriate key.

- ✎ [AUTOMATICALLY SCANNING BOTH SIDES OF AN ORIGINAL \(2-Sided Original\)](#) (page 5-55), [SPECIFYING THE ORIGINAL SCAN SIZE AND SEND SIZE](#) (page 5-56), [CHANGING THE EXPOSURE AND ORIGINAL IMAGE TYPE](#) (page 5-64), [CHANGING THE RESOLUTION](#) (page 5-66), [CHANGING THE FILE FORMAT](#) (page 5-67), [SPECIAL MODES](#) (page 5-74)

4

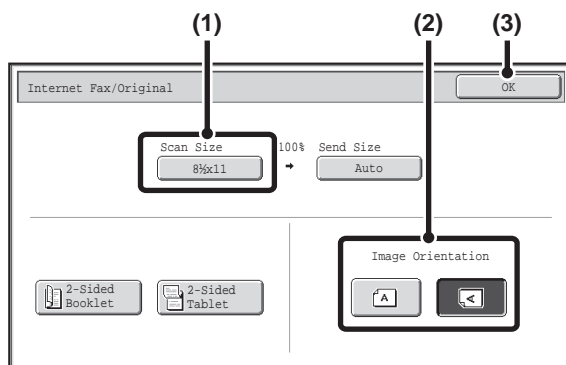

Check the original scan size and placement orientation.

In order to set the orientation of the image to be sent, check the size and orientation of the original that were set in step 1.

- (1) Check the scan size.

Check if the size of the placed original is displayed. If the displayed size is different from the size of the placed original, set the original size.

- ✎ [SPECIFYING THE ORIGINAL SCAN SIZE AND SEND SIZE](#) (page 5-56)

- (2) Touch the appropriate orientation key.

If the top edge of the original is up, touch the key. If the top edge of the original is to the left, touch the key.

- (3) Touch the [OK] key.

You will return to the screen of step 2.



- The placement orientation of the original is initially set to . If you placed the original with the top edge to the left, this step is not necessary.
- The original size set in the system settings appears as the original size.

5

Press the [START] key.

Scanning begins.

- If the original is placed on the document glass, the [Read-End] key appears in the touch panel. If the original is only one page, go to step 7. To scan more pages, go to the next step.
- If the original was inserted in the document feeder tray, a beep will sound when scanning is completed and transmission will take place.

6

If the original was placed on the document glass, replace it with the next original and press the [START] key.

Repeat until all originals have been scanned.



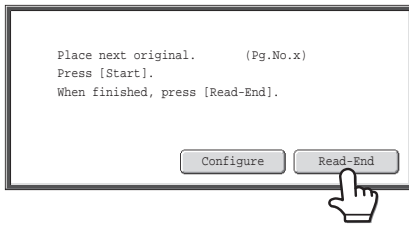

## Touch the [Read-End] key.

A beep will sound to indicate that the operation is completed. Open the automatic document feeder and remove the original.



- If no action is taken for one minute after the confirmation screen appears, scanning automatically ends and the transmission is reserved.
- The [Configure] key can be touched to change the exposure, resolution, scan size, and send size for each original page scanned. However, "Card Shot" is selected in the special modes, only the exposure can be changed when scanning an even-numbered original page.



- When all originals have been scanned, "Job stored." will be displayed together with a job control number. This number can be used to locate the job in the Transaction Report or in the Image Sending Activity Report. If the job is a broadcast transmission, this number will also appear in the key of the job in the job status screen. For this reason, making a note of the number is useful for checking the result.
- If the memory becomes full while the originals are being scanned, a message will appear and scanning will stop.
- **Storing a mail signature**  
You can have preset text automatically added at the end of e-mail messages as a mail signature. This is convenient when you wish to have a corporate policy or other preset text appear at the bottom of e-mail messages. To store the text for the mail signature, click [Application Settings], [Network Scanner Settings] and then [Administration Settings] in the Web page menu. (Administrator rights are required.) Up to 900 characters can be entered. (The mail signature is not included in the maximum number of characters that can be entered in the e-mail message.)  
Use "Pre-Setting Mail Signature" in the system settings (administrator) to specify whether or not a mail signature is added.



### To cancel scanning...

Press the [STOP] key (⏹) to cancel the operation.



- **System Settings (Administrator): I-Fax Send Settings**  
This is used to select Internet fax transmission settings such as the receive report setting, rotation setting, size restriction setting, and sender information attachment setting.
- **System Settings (Administrator): Pre-Setting Mail Signature**  
Use this setting to specify whether or not a mail signature is added at the end of e-mail messages. By factory default, a mail signature is not added.

# CHANGING THE SUBJECT, FILE NAME, AND BODY TEXT

The subject, file name, and body text can be changed when performing an Internet fax transmission. Preset items can be selected or text can be directly entered.

- If the subject and file name are not changed, the settings in the Web page are used.
- Selections for the subject, file name, and body text are configured by clicking [Application Settings] and then [Network Scanner Settings] in the Web page menu.
- For the procedure for entering text, see "[ENTERING TEXT](#)" (page 1-76) in "1. BEFORE USING THE MACHINE".

## 1 Touch the [Send Settings] key in the base screen.

 [BASE SCREEN](#) (page 5-9)

## 2

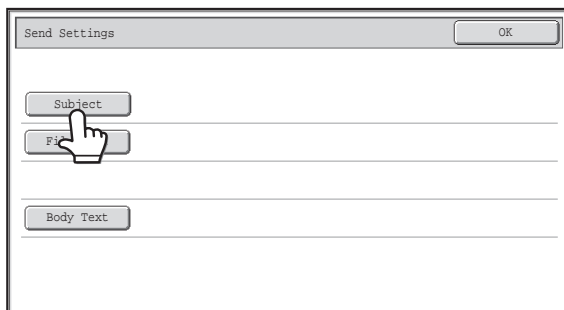

To change the subject, touch the [Subject] key.

## 3

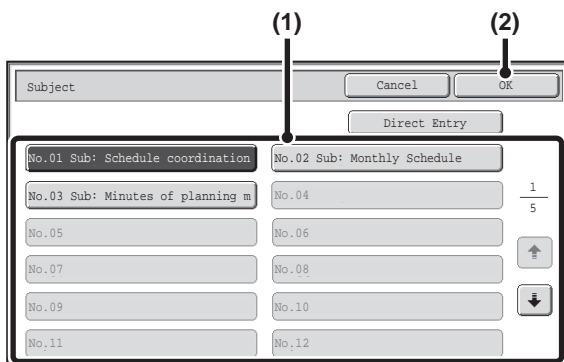

Enter the subject.

- (1) Touch a pre-set text key.
- (2) Touch the [OK] key.

- If you wish to directly enter the text, touch the [Direct Entry] key to open the text entry screen. Enter the text and touch the [OK] key.
- The text in a pre-set text key can be edited by touching the pre-set text key and then the [Direct Entry] key. The text entry screen will appear with the selected pre-set text entered. (When a destination is stored using the Web page, up to 80 characters can be entered. However, only 54 characters can be entered in the touch panel.)

4

Send Settings OK

Subject Sub: Schedule coordination meeting

File Name

Body Text

**To change the file name, touch the [File Name] key.**

The file name is entered in the same way as the subject.

5

Send Settings OK

Subject Sub: Schedule coordination meeting

File Name Material for planning meeting

Body Text

**To change the body text, touch the [Body Text] key.**

6

Body Entry Clear All OK

Thank you for your continuous support. We have attached scanned which you have requested. █

Pre-Set Select Edit ▲ ▼

**Enter the body text and touch the [OK] key.**

- To select a pre-set message previously stored in the Web page, touch the [Pre-Set Select] key.
- To directly enter the message, touch the [Edit] key.



- 1800 characters can be entered. (A line break counts as one character.)
- To clear all entered text, touch the [Clear All] key. When this key is touched, the entire body of the message is erased immediately; not just the selected line.
- Each line of the entered text can be selected with the ▼ ▲ keys. To edit the selected line, touch the [Edit] key. The text entry screen will appear with the selected text entered.

7

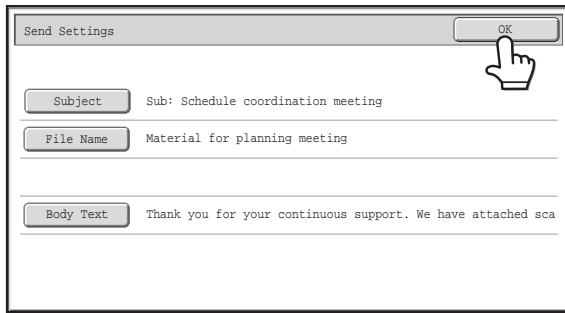

Send Settings

OK

Subject Sub: Schedule coordination meeting

File Name Material for planning meeting

Body Text Thank you for your continuous support. We have attached sca

Touch the [OK] key.



When storing pre-set text for the subject and file name in the Web pages, up to 80 characters can be entered.



**System Settings (Administrator): The Number of File Name/Subject/Body Keys Displayed Setting**

The setting for the number of subject keys and file name keys displayed in one screen can be changed to 6, 12, or 18.

# SENDING THE SAME IMAGE TO MULTIPLE DESTINATIONS (Broadcast Transmission)

The same scanned image can be sent to multiple scan modes, Internet fax mode, and fax mode destinations in a single operation. Up to 500 destinations can be selected in one broadcast operation.

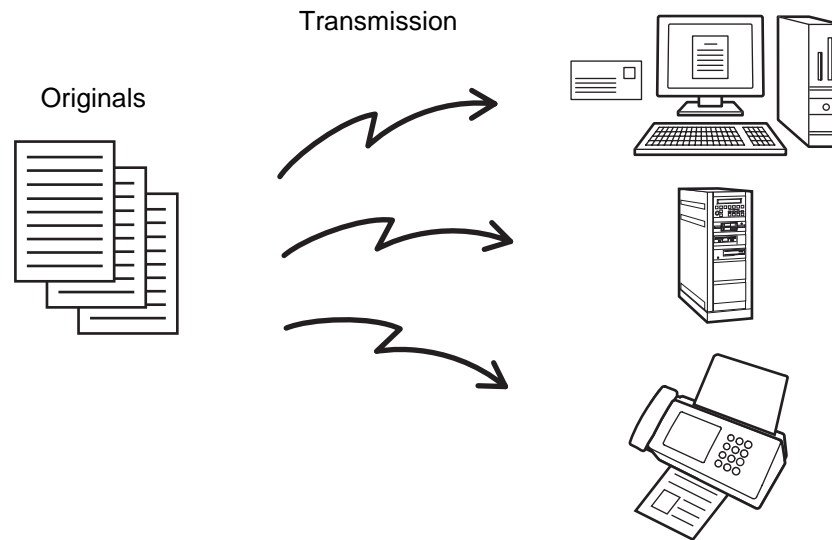

If you frequently use broadcasting to send images to the same group of destinations, it is convenient to store those destinations in a group key.

## Place the original.

1

Place the original face up in the document feeder tray, or face down on the document glass.

➤ [PLACING THE ORIGINAL](#) (page 1-37)

When the original is a different size than the size setting, set the original size.

➤ [SPECIFYING THE ORIGINAL SCAN SIZE AND SEND SIZE](#) (page 5-56)

2

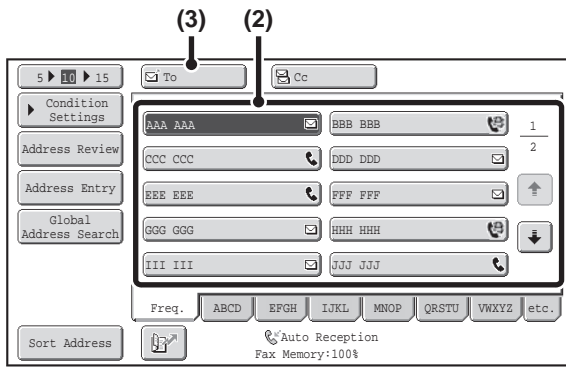

### Specify the destination.

(1) Touch the [Address Book] key in the base screen.

For the [Address Book] key, see "BASE SCREEN" (page 5-9).

(2) Touch the one-touch key of the desired destination.

(3) Touch the [To] key.

The destination is specified.

(4) Repeat steps (2) and (3) until all destinations are selected.



- To add Cc or Bcc recipients, select a recipient and touch the [Cc] key or the [Bcc] key.
- If "Must Input Next Address Key at Broadcast Setting" is enabled in the system settings (administrator), touch the [Next Address] key before specifying the next destination.
- One-touch keys that cannot be used for broadcast transmission are grayed out to prevent selection.
- If a Scan to FTP (Hyperlink) address is specified in a broadcast transmission, hyperlink e-mail transmission will not take place.
- If you frequently use broadcasting to send images to the same group of destinations, it is convenient to store those destinations in a group key.

3

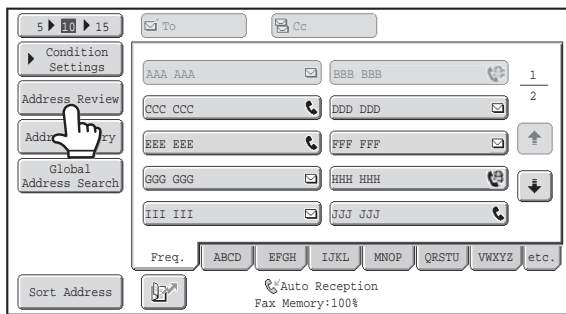

### Touch the [Address Review] key.

4

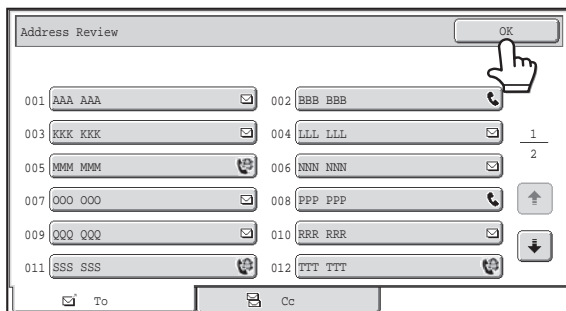

### Check the destinations and then touch the [OK] key.



If the transmission includes Cc or Bcc destinations, touch the [Cc] tab or the [Bcc] tab to check those destinations.



#### To cancel a specified destination...

Touch the one-touch key of the destination that you wish to cancel. A message will appear to confirm the deletion. Touch the [Yes] key.

CHECKING AND DELETING THE SELECTED DESTINATIONS (page 5-20)

## Press the [START] key.

Scanning begins.

- If you inserted the original pages in the document feeder tray, all pages are scanned.  
A beep will sound to indicate that scanning is finished.
- If you are scanning the original on the document glass, scan each page one page at a time.  
When scanning of one page finishes, replace it with the next page and press the [START] key. Repeat until all pages have been scanned and then touch the [Read-End] key.  
A beep will sound to indicate that scanning is finished.



If Internet fax or fax destinations are included in the broadcast transmission, scanning will take place in [Mono2].



### To cancel scanning...

Press the [STOP] key (⏏) to cancel the operation.

# BROADCAST TRANSMISSIONS THAT INCLUDE INTERNET FAX DESTINATIONS

When a broadcast transmission includes both scan mode and Internet Fax mode destinations, the Internet Fax mode settings (original orientation and other various settings) are given priority. When performing this type of broadcast transmission, note the information below.

<b>Original placement orientation</b>	The orientation of Internet fax mode is given priority. When "Rotation Sending Setting" is enabled in the system settings (administrator), the image is rotated 90 degrees. For this reason, in some cases the image may not be displayed in the correct orientation.
<b>Send size</b>	When the file format is set to [TIFF-S] in Internet fax mode, transmission is only possible in 8-1/2" x 11" (A4 in landscape orientation) size.
<b>Exposure</b>	The Internet fax settings are given priority.
<b>Resolution</b>	When the file format is set to [TIFF-S] in Internet fax mode and a high resolution setting is selected in scan mode, the resolution will be changed to [200X200dpi].
<b>File compression mode</b>	The compression mode will be changed to the compression mode set in "Compression Mode at Broadcasting" in the system settings (administrator).
<b>Color scanning</b>	Scanning will take place in Mono2 regardless of the color mode setting.
<b>Scan file size</b>	If a broadcast transmission is performed that includes destinations for which an attachment size limit has been set using "Maximum Size of E-mail Attachments (E-mail)" or "Maximum Size of Data Attachments (FTP/Desktop/Network Folder)" in the system settings (administrator), the limit will also apply to destinations for which a limit is not set. (The limitation setting of Scan to E-mail or Internet fax is given priority.)

## Resending to unsuccessful broadcast transmission destinations

The results of a completed broadcast transmission can be checked in the job status screen. If transmission to any of the addresses failed, resend the image to those addresses.

1

JOB STATUS



Press the [JOB STATUS] key.

2

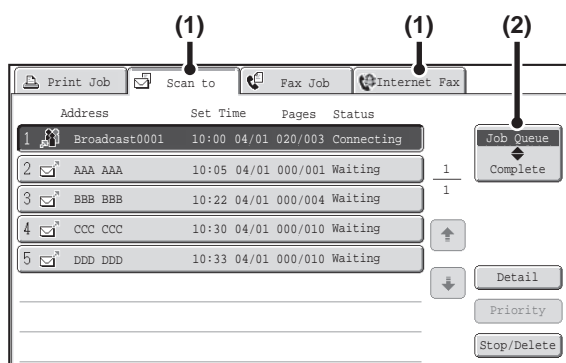

Display the jobs completed screen.

- (1) Touch the tab of the mode that you wish to display.
- (2) Touch the [Complete] key.



If the broadcast transmission included destinations of different modes, the same broadcast transmission key will appear in each of those modes.



3

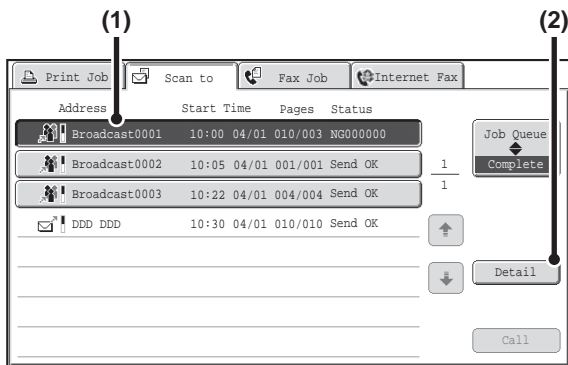

**Display details on the broadcast transmission.**

- (1) Touch the key of the completed broadcast transmission.
- (2) Touch the [Detail] key.



"Broadcastxxxx" will appear as the address of the broadcast job key. The job control number that appeared in the touch panel when scanning ended appears in "xxxx".

4

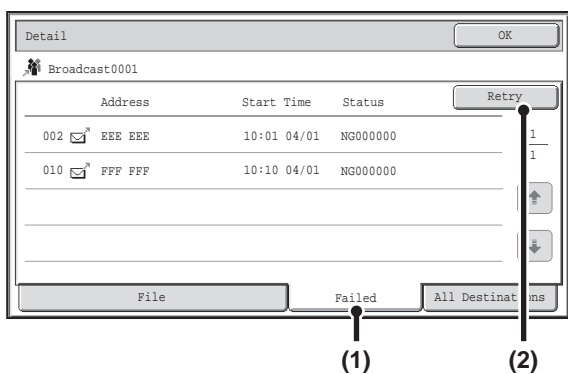

**Resend the image to the unsuccessful destinations.**

- (1) Touch the [Failed] tab.
- (2) Touch the [Retry] key.



- The steps to follow after the [Retry] key is touched differ depending on whether or not the document filing function is used.

**Not using document filing**

You will return to the base screen with the unsuccessful destinations entered. Place the original and perform the steps of the broadcast transmission.

**Using document filing**

You will return to the document filing resend screen with the unsuccessful destinations entered. Perform the document filing resend procedure. (There is no need to rescan the original.)

- If the [All Destinations] tab is touched in (1), all destinations will be displayed. The [Retry] key that appears in the screen can be touched to resend to all the destinations.

---

---

# SENDING AN INTERNET FAX FROM A COMPUTER (PC-I-Fax)

A file on a computer can be sent via the machine as an Internet fax (PC-I-Fax function). Internet faxes are sent using the PC-I-Fax function in the same way as documents are printed. Select the PC-Fax driver as the printer driver for your computer and then select the Print command in the software application. Image data for transmission will be created and sent as an Internet fax.

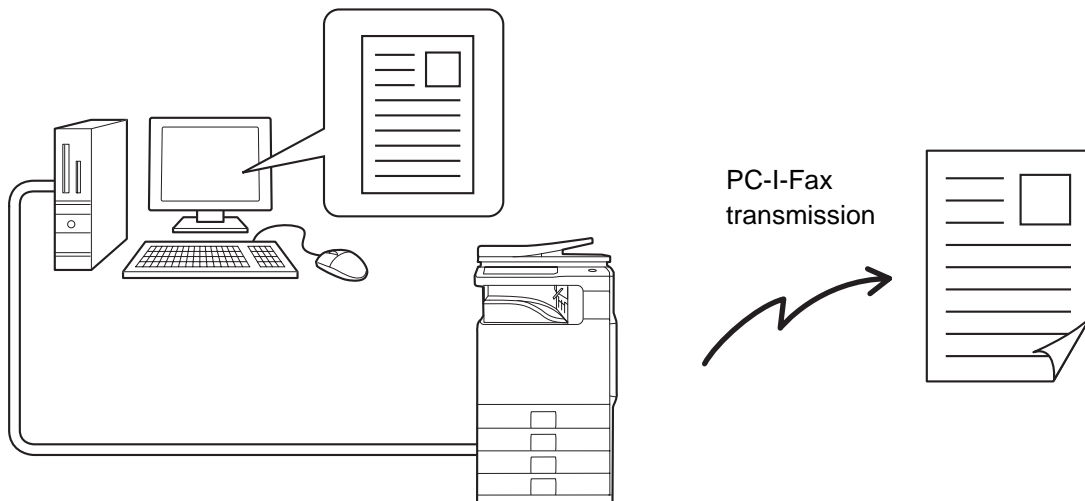

For the procedures for using this function, see the PC-Fax driver Help.



- To send an Internet fax using the PC-I-Fax function, the PC-Fax driver must be installed and then updated using the CD-ROM that accompanies the Internet fax expansion kit. For more information, see the Start Guide.
- This function can only be used on a Windows computer.
- This function can only be used for transmission. Internet faxes received on the machine cannot be received to a computer that is connected to the machine.

# IMAGE SETTINGS

Settings for scanning the original are selected in the base screen of each mode. The current state of each setting appears to the right of the key used to select the setting.

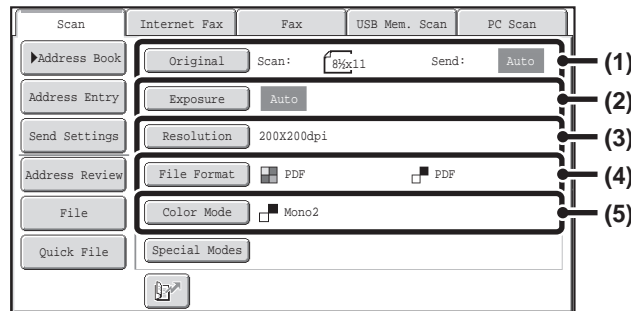

## (1) [Original] key

Touch this key to set the scan size, send size, and orientation of the original, and select 2-sided scanning settings.

➤ [AUTOMATICALLY SCANNING BOTH SIDES OF AN ORIGINAL \(2-Sided Original\)](#) (page 5-55),  
 ➤ [SPECIFYING THE ORIGINAL SCAN SIZE AND SEND SIZE](#) (page 5-56)

## (2) [Exposure] key

Touch this key to select the exposure for scanning.

➤ [CHANGING THE EXPOSURE AND ORIGINAL IMAGE TYPE](#) (page 5-64)

## (3) [Resolution] key

Touch this key to select the resolution for scanning.

➤ [CHANGING THE RESOLUTION](#) (page 5-66)

## (4) [File Format] key

Touch this key to change the format (file type) of the scanned image file.

➤ [CHANGING THE FILE FORMAT](#) (page 5-67)

## (5) [Color Mode] key

Touch this key to select the color mode for scanning. This key does not appear in Internet fax mode.

➤ [CHANGING THE COLOR MODE](#) (page 5-71)

# AUTOMATICALLY SCANNING BOTH SIDES OF AN ORIGINAL (2-Sided Original)

The automatic document feeder can be used to automatically scan both sides of an original.

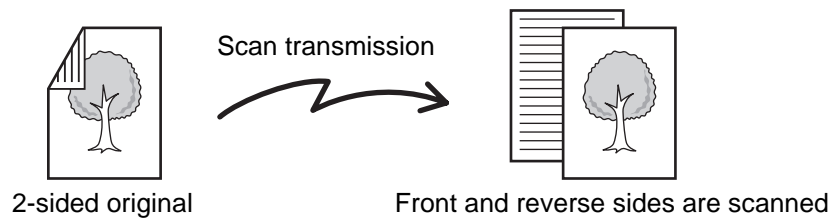

1

## Select the mode and display the image settings screen.

- (1) Touch the tab of the mode that you wish to use.
- (2) Touch the [Original] key.  
 [IMAGE SETTINGS](#) (page 5-54)

2

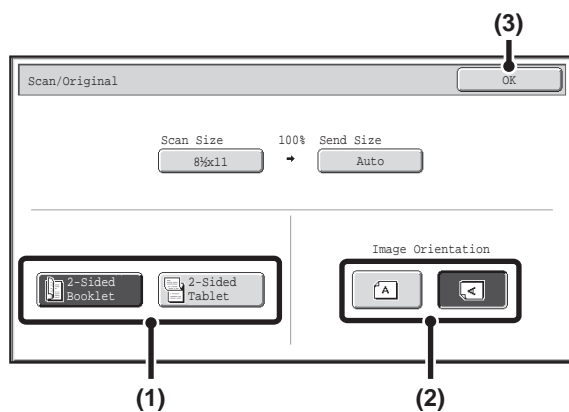

## Specify the binding style of the 2-sided original (book or tablet) and the orientation in which the original is placed.

- (1) Touch the [2-Sided Booklet] key or the [2-Sided Tablet] key.

A book and a tablet are bound as shown below.

Book



Tablet



- (2) Touch the appropriate [Image Orientation] key.

If this setting is not correct, a suitable image may not be transmitted.

- (3) Touch the [OK] key.



To cancel 2-sided scanning, touch the highlighted key so that it is no longer highlighted.



2-sided scanning automatically turns off after the transmission operation is completed.

# SPECIFYING THE ORIGINAL SCAN SIZE AND SEND SIZE

When the original is placed, the original size and the send size set in the system settings appear in the base screen as the original size and send size.

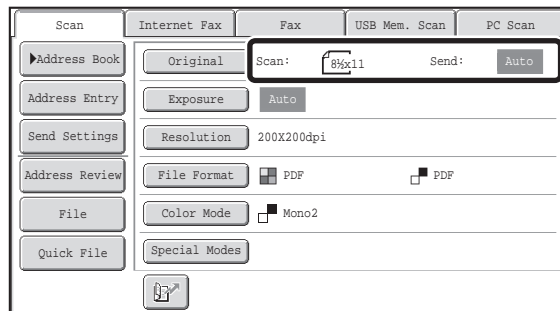

In the above screen, the scan size (the original size) is 8-1/2" x 11" (A4) and the send size is auto. For example, if the scan size is 8-1/2" x 11" (A4) and the send size is 5-1/2" x 8-1/2" (B5), the image will be reduced before transmission.

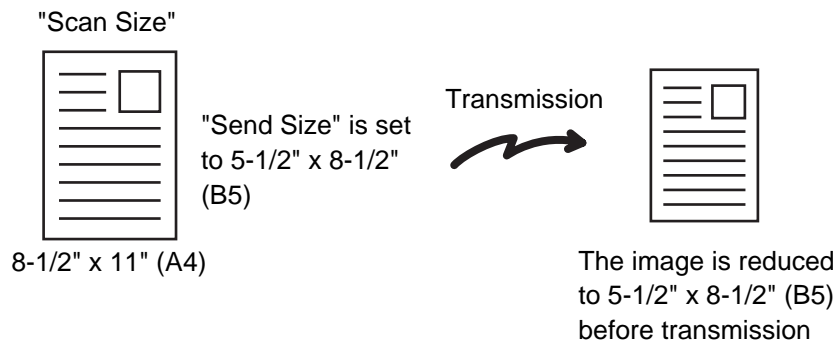

If the size of the placed original is different from the displayed original size, specify the original size.

- ☞ [Specifying the original scan size \(by paper size\)](#) (page 5-57)
- ☞ [Specifying the original scan size \(by numerical values\)](#) (page 5-59)



- **System Settings (Administrator): Default Original Size Settings**

Set this if you frequently use a particular original size. The set size will appear in the [Original] key. When this setting is configured, changing the original size can be omitted.

- **System settings (Administrator): Setting of Default Original Exit Place (MX-B402SC Only)**

When the automatic document feeder is used, the original's default output destination can be set to the upper exit or the heavy exit. (Except when "Size Input" or "Card Size" is selected for the original size.)

## Specifying the original scan size (by paper size)

If the size of the placed original is different from the displayed original size or you wish to change the original size, you must touch the [Original] key and directly specify the original size.

Place the original in the document feeder tray or on the document glass and follow the steps below.

### Select the mode and display the image settings screen.

**1**

(1) Touch the tab of the mode that you wish to use.

(2) Touch the [Original] key.

The original size set in the system settings appears to the right of the [Original] key.

 [IMAGE SETTINGS](#) (page 5-54)

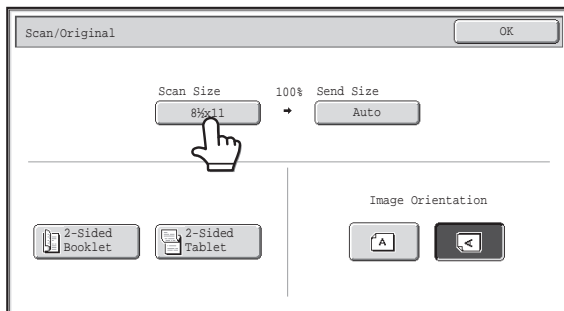
**2**

Touch the [Scan Size] key.

**MX-B402:**

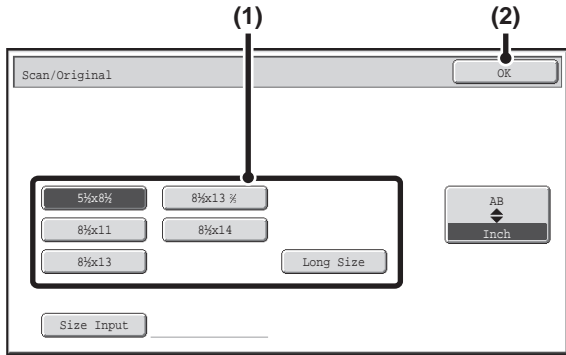

**Specify the scan size.**

- (1) Touch the appropriate original size key.
- (2) Touch the [OK] key.

**MX-B402SC:**

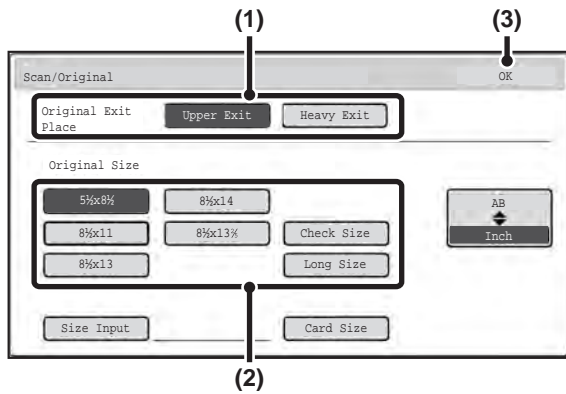

**Specify the scan size.**

- (1) Touch the original output destination.
- (2) Touch the appropriate original size key.
- (3) Touch the [OK] key.

3



- If you are sending a long original, touch the [Long Size] key. Use the automatic document feeder to scan a long original. The maximum width that can be scanned is 19-5/8" (500 mm) (the maximum height is 8-1/2" (216 mm)).
- To specify an AB size for the scan size, touch the [AB] key to highlight the [AB] side and then specify the scan size.

**MX-B402-SC Only**

- In the situations below, the original exit place is fixed to the heavy exit.
  - When "Card Size" is selected
  - When the original guide is set to 2 7/8" (74 mm) or lower (Except when "Check Size" is selected)
  - When the automatic document feeder is scanning an original with an X (horizontal) value of 4 1/8" (105 mm) or less
- When "Card Size" is selected, you cannot copy if the original guide is set to 2 7/8" (74 mm) or higher.

4

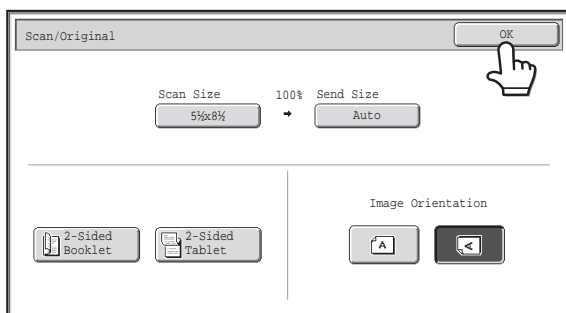

**Touch the [OK] key.**



When [Long Size] is selected, the 2-sided scanning setting and send size cannot be changed. In addition, when only scan destinations are selected for scan transmission or metadata transmission, scanning will take place in Mono2.

## Specifying the original scan size (by numerical values)

When scanning a non-standard size original such as a card, follow these steps to specify the original size.

**Select the mode and display the image settings screen.**

**1**

(1) Touch the tab of the mode that you wish to use.

(2) Touch the [Original] key.

The original size set in the system settings appears to the right of the [Original] key.

 [IMAGE SETTINGS](#) (page 5-54)

**2**

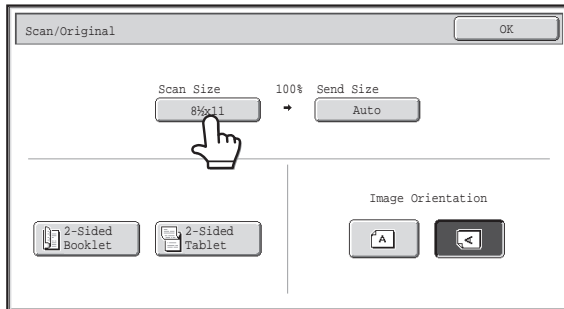

**Touch the [Scan Size] key.**

**MX-B402:**

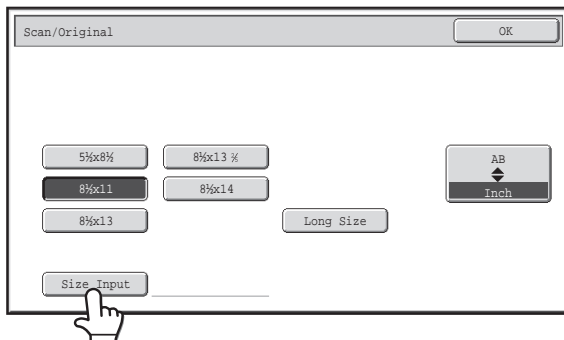

**Touch the [Size Input] key.**

**3**

**MX-B402SC:**

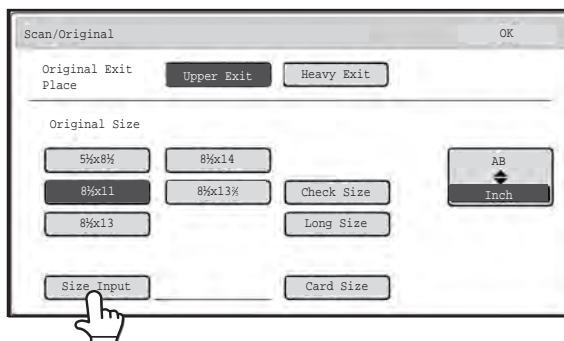

 If the [Card Size] key is touched, "X86 Y54" is set in [Size Input].



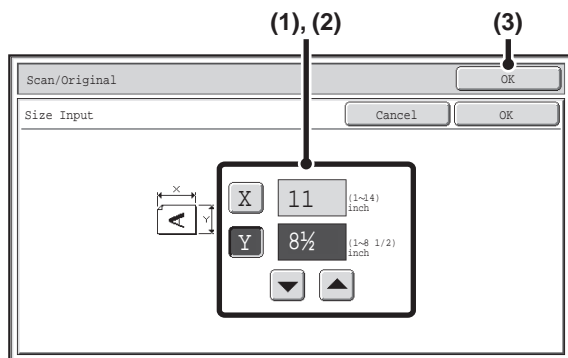

## Enter the scan size (original size).

### (1) Enter the X (horizontal) dimension of the original.

With the [X] key highlighted, enter the X (horizontal) dimension of the original with the  $\blacktriangledown$   $\blacktriangle$  keys. When the document glass is used, enter a number from 1" to 11-5/8" (25 mm to 297 mm).

#### **MX-B402:**

When the automatic document feeder is used, enter a number from 3-1/2" to 14" (89 mm to 356 mm). When a number which is from 5-3/8" (139 mm) and less is entered in 2-Sided scanning setting, an original cannot be scanned.

If the horizontal dimension of the original is less than 3-1/2" (89 mm), use the document glass.

#### **MX-B402SC:**

When the automatic document feeder is used, enter a number from 3-1/4" to 14" (85 mm to 356 mm). When a number which is from 3-1/8" (84 mm) and less is entered in 2-Sided scanning setting, an original cannot be scanned.

If the horizontal dimension of the original is less than 3-1/4" (85 mm), use the document glass.

### (2) Enter the Y (vertical) dimension of the original.

Touch the [Y] key and enter the Y (vertical) dimension of the original with the  $\blacktriangledown$   $\blacktriangle$  keys. When the document glass is used, enter a number from 1" to 8-1/2" (25 mm to 216 mm).

#### **MX-B402:**

When the automatic document feeder is used, enter a number from 4" to 8-1/2" (100 mm to 216 mm). If the vertical dimension of the original is less than 4" (100 mm), use the document glass.

#### **MX-B402SC:**

When the automatic document feeder is used, enter a number from 2" to 8-1/2" (51 mm to 216 mm). If the vertical dimension of the original is less than 2" (51 mm), use the document glass.

### (3) Touch the [OK] key.

Touch the [OK] key next to the [Cancel] key to complete the setting and return to the screen of step 3.



#### **MX-B402:**

- When a number from 11-3/4" to 14" (298 mm to 356 mm) to the X (horizontal) dimension and a number from 1" to 3-7/8" (25 mm to 99 mm) to the Y (vertical) dimension are entered at the same time, an original cannot be scanned.

#### **MX-B402SC:**

- When a number from 11-3/4" to 14" (298 mm to 356 mm) to the X (horizontal) dimension and a number from 1" to 1-7/8" (25 mm to 50 mm) to the Y (vertical) dimension are entered at the same time, an original cannot be scanned.
- When the X (horizontal) value is set to 4 1/8" (105 mm) or lower and the Y (vertical) value is set to 2 7/8" (74 mm) or lower, "Card Size" is automatically selected and the original exit place is fixed to the heavy exit.

5



### Touch the [OK] key.

The specified size appears in the [Scan Size] key.



- When the scan size is specified by numerical values, the send size cannot be specified.
  - When the automatic document feeder is used, an original longer than 11-5/8" (297 mm) can be scanned (maximum width 19-5/8" (500 mm)). In this case, touch the [Long Size] key in the screen of step 3.
- 👉 [Specifying the original scan size \(by paper size\)](#) (page 5-57)

## Specifying the send size of the image

Specify the send size as a paper size. If a send size bigger than the scan size is selected, the image will be enlarged. If a send size smaller than the scan size is selected, the image will be reduced.



- The send size cannot be specified when [Long Size] is selected for the scan size, or when the scan size is specified by numerical values.
- The send size cannot be specified when [TIFF-S] is selected for the format in Internet fax mode. (The send size is fixed at 8-1/2" x 11" (A4 in landscape orientation).)

1

### Select the mode and display the image settings screen.

(1) Touch the tab of the mode that you wish to use.

(2) Touch the [Original] key.

[IMAGE SETTINGS](#) (page 5-54)

2

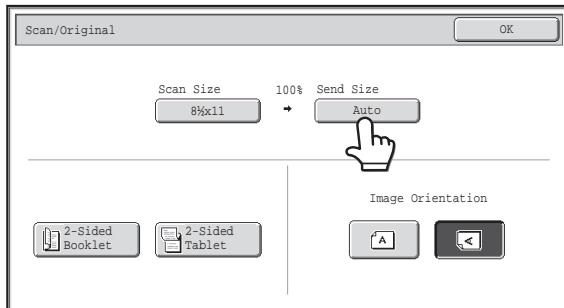

Touch the [Send Size] key.

3

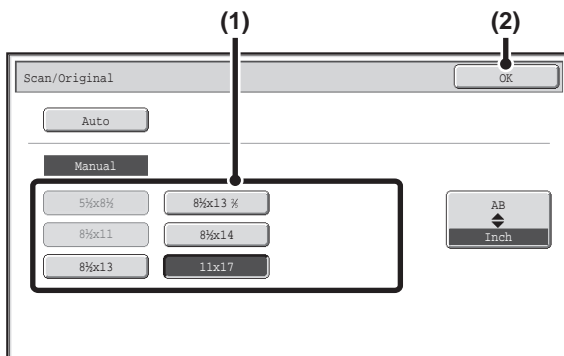

Specify the send size.

(1) Touch the desired send size key.

(2) Touch the [OK] key.



- Depending on the paper size specified for the "Scan Size", it may not be possible to select some sizes for the "Send Size". Size keys that cannot be specified for the "Send Size" are grayed out to prevent selection.
- To specify an AB size for the send size, touch the [AB  $\blacktriangleleft$   $\blacktriangleright$  Inch] key to highlight the [AB] side and then specify the send size.

4

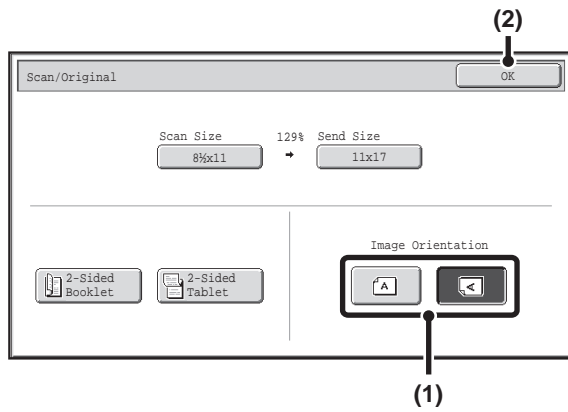

**Specify the orientation in which the original is placed.**

**(1) Touch the appropriate [Image Orientation] key.**

If this setting is not correct when sending an image with a changed ratio, a suitable image may not be transmitted.

**(2) Touch the [OK] key.**



The ratio used for reduction or enlargement of the original will appear between the "Scan Size" and the "Send Size".

# CHANGING THE EXPOSURE AND ORIGINAL IMAGE TYPE

The exposure and original image type can be set appropriately for the original to enable optimum scanning. Refer to the following tables to select appropriate settings.

## How to select the exposure

Exposure		When to select
Auto		This setting automatically adjusts the exposure for light and dark parts of the original.
Manual	1-2	Select this setting when the original consists of dark text.
	3	Select this setting for a normal original (neither dark nor light).
	4-5	Select this setting when the original consists of faint text.

## How to select the original image type (Scan mode, USB memory mode and Data entry mode)

Setting		Description
Auto		The original image type is automatically selected to match the original.
Manual	Text/Prt'd. Photo	This mode provides the best balance for scanning an original which contains both text and printed photographs, such as a magazine or catalogue.
	Text/Photo	This mode provides the best balance for scanning an original which contains both text and photographs, such as a text document with a photo pasted on.
	Text	Use this mode for regular text documents.
	Photo	Use this mode to scan photos.
	Printed Photo	This mode is best for scanning printed photographs, such as photos in a magazine or catalogue.
	Map	This mode is best for scanning the color shading and fine details found on most maps.

### 1 Select the mode and display the exposure settings screen.

- (1) Touch the tab of the mode that you wish to use.
- (2) Touch the [Exposure] key.

 [IMAGE SETTINGS](#) (page 5-54)

### 2

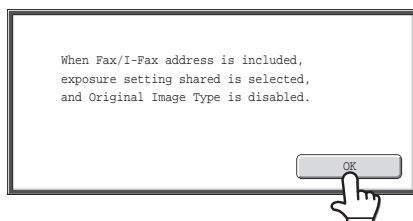





### Read the displayed message and touch the [OK] key.

This message does not appear in USB memory mode or Internet fax mode. Go to the next step.

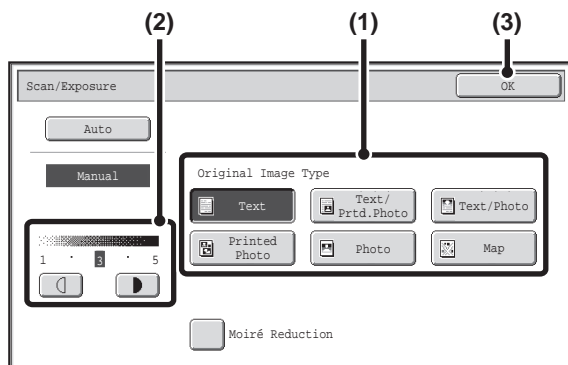



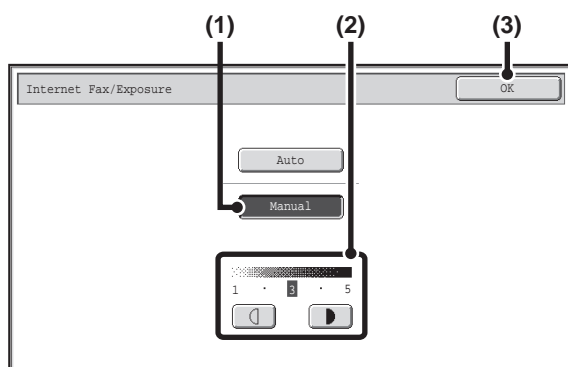

If a broadcast transmission is performed that includes both scan mode destinations and Internet fax destinations, the exposure settings for Internet fax mode will have priority.

**Scan mode, USB memory mode, Data entry mode****Select the exposure and original image type.**

- (1) **Select the original image type.**  
Touch the original image type key that matches the original image type.
- (2) **Adjust the exposure with the   keys.**  
The exposure darkens when the  key is touched, and lightens when the  key is touched.
- (3) **Touch the [OK] key.**

**3****Internet fax mode**

- (1) **Touch the [Manual] key.**
- (2) **Adjust the exposure with the   keys.**  
The exposure darkens when the  key is touched, and lightens when the  key is touched.
- (3) **Touch the [OK] key.**



- In Internet fax mode, the original image type and moiré reduction cannot be selected.
- To reduce the occurrence of line patterns (moiré effect) when scanning printed matter, touch the [Moiré Reduction] checkbox so that a checkmark  appears.



When using the document glass to scan multiple original pages, the exposure setting can be changed each time you change pages. When using the automatic document feeder, the exposure setting cannot be changed once scanning has begun. (However, when "Job Build" is used in the special modes, the exposure can be changed each time a new set of originals is inserted.)

**System Settings (Administrator): Default Exposure Settings**

This is used to change the default exposure setting.

# CHANGING THE RESOLUTION

The resolution setting can be selected.

## 1

Select the mode and display the image settings screen.

- (1) Touch the tab of the mode that you wish to use.
- (2) Touch the [Resolution] key.

 [IMAGE SETTINGS](#) (page 5-54)

## 2

Scan mode, USB memory mode, Data entry mode

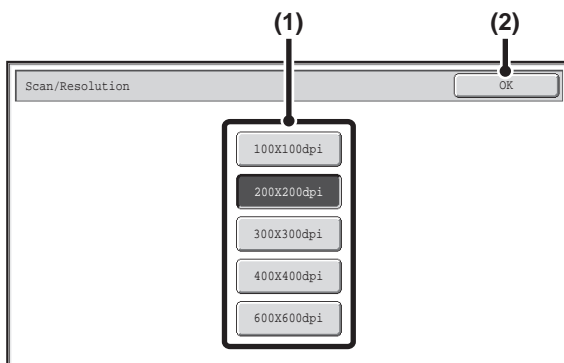

Select the resolution.

- (1) Touch the key of the desired resolution.
- (2) Touch the [OK] key.

Internet fax mode

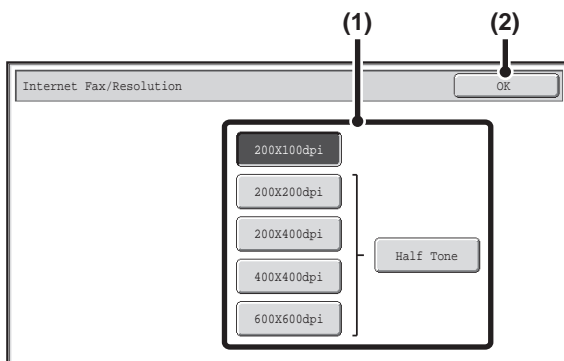

In Internet fax mode, the [Half Tone] key can be touched to select halftone (except when [200X100dpi] is selected). When the original has many gradations of light and dark such as a photo or color illustration, halftone provides a more attractive image than regular transmission.

## How to select the resolution

For normal text originals, 200X200dpi (200X100dpi in Internet fax mode) produces an image that is sufficiently legible. For photos and illustrations, a high resolution setting (600X600dpi, etc.) will produce a sharp image. However, a high resolution setting will result in a large file, and if the file is too large, transmission may not be possible. In this event, reduce the number of pages scanned or take other measures to decrease the file size.

➤ [CHANGING THE FILE FORMAT](#) (page 5-67)

[Specifying the send size of the image](#) (page 5-62)



- When using the document glass to scan multiple original pages, the resolution setting can be changed each time you change pages. When using the automatic document feeder, the resolution setting cannot be changed once scanning has begun. (However, when "Job Build" is used in the special modes, the resolution can be changed each time a new set of originals is inserted.)
- When [TIFF-S] is selected for the format in Internet fax mode, only [200X100dpi] or [200X200dpi] can be selected.



### System Settings (Administrator): Initial Resolution Setting

This is used to change the default resolution setting.

## CHANGING THE FILE FORMAT

### Changing the format

#### (Scan mode, USB memory mode and Data entry mode)

The file format (file type and compression mode/compression ratio) for sending a scanned image can be changed at the time of transmission. In addition, if the scanned originals are divided into separate files, the number of pages per file can be changed.



The file format for sending a scanned image is specified when the destination is stored in a one-touch key; however, you can change the format at the time of transmission.

# 1

### Select the mode and display the image settings screen.

- (1) Touch the tab of the mode that you wish to use.
- (2) Touch the [File Format] key.

➤ [IMAGE SETTINGS](#) (page 5-54)

# 2

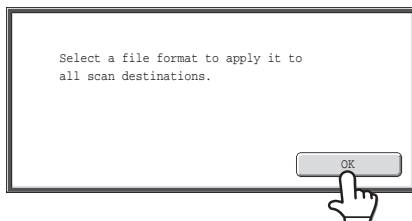

### Read the displayed message and touch the [OK] key.

The message does not appear in USB memory mode. Go to the next step.



## Set the format.

### ● Scanning in Mono2

- (1) Select the file type.
- (2) Select the compression mode.

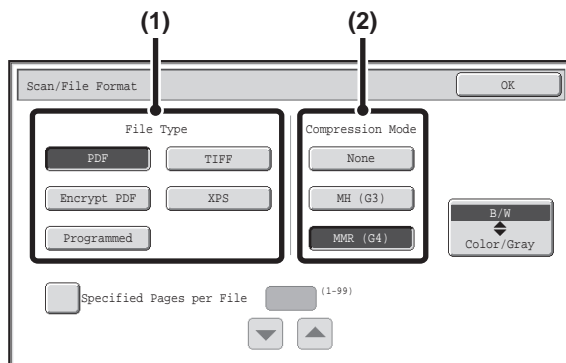

### ● Scanning in color/grayscale

- (1) Touch the indicated key to select [Color/Gray] mode.

When [Color/Gray] is highlighted, [Color/Gray] mode is selected.

- (2) Select the file type.
- (3) Select the compression ratio.

High compression results in a smaller file size, however, the image quality is slightly degraded.

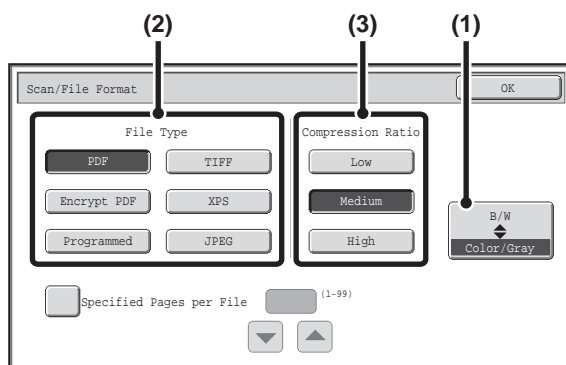

3



- The [Programmed] key does not appear in USB memory mode.
- When this screen is displayed, the setting screen of [B/W] mode initially appears.
- The format setting of [B/W] mode is the file format when the color mode is set to [Mono2].
- The format setting of [Color/Gray] mode is the file format when the color mode is set to [Auto], [Full Color], or [Grayscale].
- The file type of [B/W] mode and the file type of [Color/Gray] mode are linked. The file type cannot be set separately for each. (When [JPEG] is selected for [Color/Gray] mode, [TIFF] is automatically selected for [B/W] mode.)

4

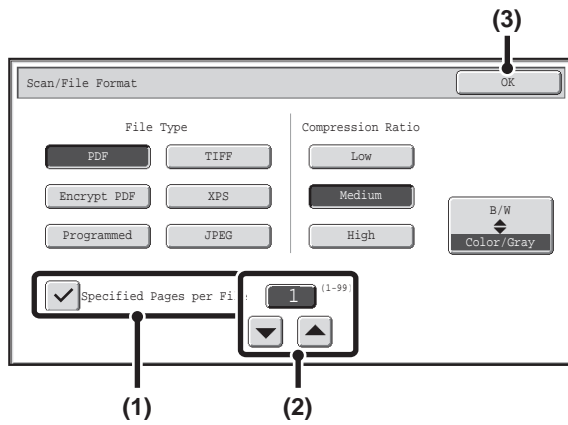

To change the number of pages per file, enter the number of pages and exit the format settings.

- (1) Touch the [Specified Pages per File] checkbox so that a checkmark  appears.
- (2) Set the number of pages per file with the   keys.
- (3) Touch the [OK] key.



- When a checkmark does not appear in the [Specified Pages per File] checkbox , one file is created for all scanned pages.
- When [Specified Pages per File] is selected, consecutive numbers are added to the created file names.
- When [JPEG] is selected for the file type, one file is created for each page (a file cannot be created for multiple pages). For this reason, the [Specified Pages per File] checkbox does not appear.



When [Encrypt PDF] is selected, a password entry screen will appear when the [START] key is pressed to begin scanning and transmission.

Touch the [Entry] key in the displayed screen to open the keyboard screen. Enter a password (maximum of 32 characters) and touch the [OK] key. Scanning and transmission will begin.



#### System Settings (Administrator): Initial File Format Setting

This sets the default file format setting for scanner transmission.

## Changing the format (Internet fax mode)

The file format for sending an Internet fax is normally set to [TIFF-F]. If the destination Internet fax machine does not support full mode (it only supports simple mode), follow the steps below to select [TIFF-S].

### 1 Switch to Internet fax mode and display the file format settings screen.

1

- (1) Touch the [Internet Fax] tab.
- (2) Touch the [File Format] key.

 [IMAGE SETTINGS](#) (page 5-54)

2

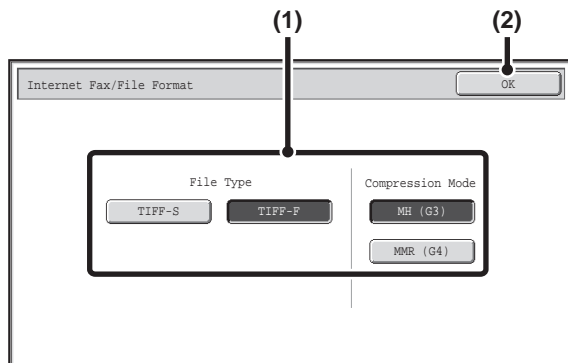

### Select the file format.

- (1) Touch the key of the desired format.  
If you selected [TIFF-F], select the compression mode.
- (2) Touch the [OK] key.



When [TIFF-S] is selected, the transmission settings are restricted as follows:

- Resolution: The selections are [200X100dpi] and [200X200dpi]. If [TIFF-S] is selected after [200X400dpi], [400X400dpi] or [600X600dpi] is selected, the resolution automatically changes to [200X200dpi].
- Send size: It is always 8-1/2" x 11" (A4) in landscape orientation. If [TIFF-S] is selected after the send size is changed, the send size is automatically changed to 8-1/2" x 11" (A4) in landscape orientation. If a size larger than 8-1/2" x 11" (A4) is scanned, the size will automatically be reduced to 8-1/2" x 11" (A4) in landscape orientation. When this format is included in a broadcast transmission, the image will be transmitted to all destinations at 8-1/2" x 11" (A4) in landscape orientation.
- Special modes: When a ratio setting is selected and the original size is entered, Card Shot cannot be used.



#### System Settings (Administrator): Compression Setting

This is used to set the default compression mode for Internet fax transmission.

# CHANGING THE COLOR MODE

This procedure is used to change the color mode used to scan the original when the [START] key is pressed.

 This function cannot be used in Internet fax mode.

Mode		Scanning method
Auto	Grayscale	The machine detects whether the original is color or black and white and automatically selects full color or black and white (Mono2 or Grayscale) scanning.
	Mono2	
Full Color		The original is scanned in full color. This mode is best for full color originals such as catalogues.
Grayscale		The colors in the original are scanned in black and white as shades of gray (grayscale).
Mono2		Colors in the original are scanned as black or white. This mode is best for text-only originals.

## Select the mode and display the color mode settings screen.

- 1 (1) Touch the tab of the mode that you wish to use.
- (2) Touch the [Color Mode] key.

 [IMAGE SETTINGS](#) (page 5-54)

2

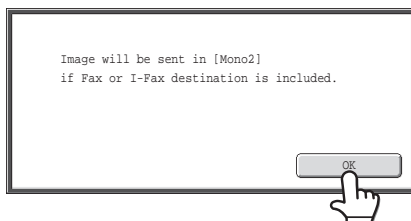

## Read the displayed message and touch the [OK] key.

A message does not appear in USB memory mode. Go to the next step.

 When a broadcast transmission is performed using mixed send modes, the image is sent in Mono2.

3

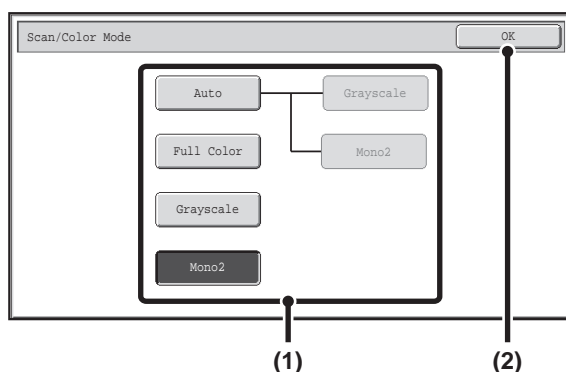

## Select the color mode.

- (1) Touch the key of the desired color mode.  
If [Auto] is selected, select whether or not the original will be scanned in grayscale or mono2 when it is detected that the original is a black & white original. Note that if the file format is set to JPEG, scanning will take place in grayscale.
- (2) Touch the [OK] key.



- **System Settings (Administrator): Default Color Mode Settings**

The default color mode can be changed.

- **System Settings (Administrator): Disable Change of B/W Setting in Auto Mode**

This prohibits selection of the black and white original scanning setting when [Auto] is selected for the color mode.

# CHECKING THE IMAGE TO BE TRANSMITTED (Preview)

**MX-B402SC**

If you touch the [Preview] key before scanning the original, you can check the scanned image in the touch panel before sending the image.

\* The factory default setting is disabled.



Depending on the size of the transmission data, part of the preview image may not appear in the preview screen in the touch panel.

**1**

## Place the original.

Place the original in the document feeder tray or on the document glass as appropriate for the functions stored in the program.

**2**

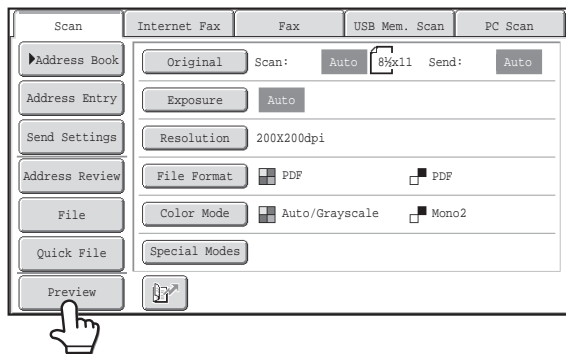

Touch the [Preview] key to highlight it.

**3**

## Select transmission settings and touch the the [START] key.

"Originals are being read" appears while the originals are being scanned, and when scanning is finished, the preview screen appears on the touch panel. Transmission will not take place until you touch the [Start Sending] key in the preview screen.

**4**

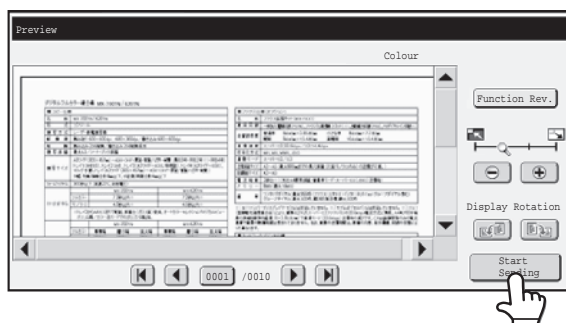

Check the preview image and then touch the [Start Sending] key.

Transmission begins.

For information on the preview screen, see "[PREVIEW CHECK SCREEN](#)" (page 5-73).



### System settings (administrator): Default Preview

You can specify whether or not the [Preview] key function will be enabled in the base screens of the image send modes and in the address book.

# PREVIEW CHECK SCREEN

This section explains the preview check screen.

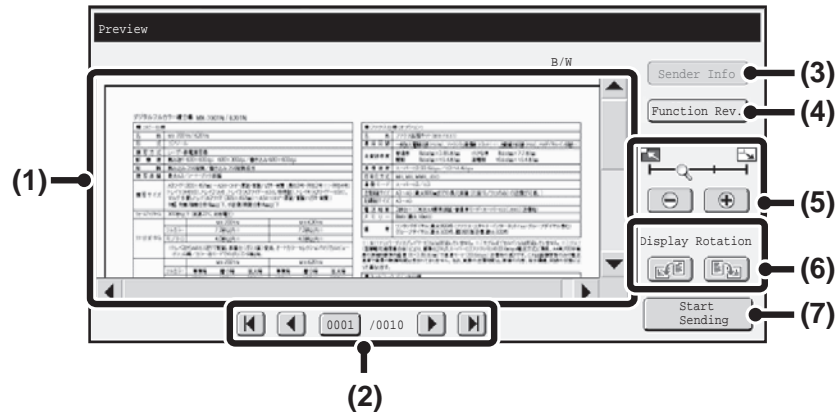

## (1) Preview image

A preview of the scanned original appears. If the image is cut off, use the scroll bars at the right and bottom of the screen to scroll the image. Touch a bar and slide it to scroll. (You can also touch the keys to scroll.)

## (2) Change page keys

When there are multiple pages, use these keys to change pages.

- keys: Go to the first or the last page.
- keys: Go to the previous page or the next page.
- Page number display: This shows the total number of pages and the current page number. You can touch the current page number key and enter a number with the numeric keys to go to that page number.

## (3) [Sender Info] key

When Internet fax mode is selected, touch to display the sender information for I-fax own address send. This key can only be touched when the entire preview image is displayed in the preview screen.

## (4) [Function Rev.] key

Touch to check special mode settings or scan settings for two-sided originals.

## (5) Display zoom key

Use this to set the zoom ratio of the displayed image. Changes from the left in the order "Full Page", "Twice", "4 Times", "8 Times". The setting applies to all pages in the file, not just the displayed page.

## (6) "Display Rotation" key

This rotates the image right or left by 90 degrees. The rotation applies to all pages in the file, not just the displayed page.

## (7) [Start Sending] key

Touch to begin transmission.



- A preview image is an image for display on the touch panel. It will differ from the actual print result.
- The preview image reflects certain scanning and special mode settings. Settings reflected in the preview image are as follows:  
Scanning settings: Original, Color Mode  
Special modes: Erase, Suppress Background, Card Shot, Drop Out Color, Blank Page Skip

# SPECIAL MODES

This section explains special modes that can be used in scan send mode.

## SPECIAL MODES

When the [Special Modes] key is touched in the base screen, the special modes menu screen appears. When the [OK] key is touched in the special modes screen, the selected settings are entered and the base screen reappears.

 [Internet fax mode](#) (page 5-75)

### Scan mode, USB memory mode, Data entry mode

MX-B402:

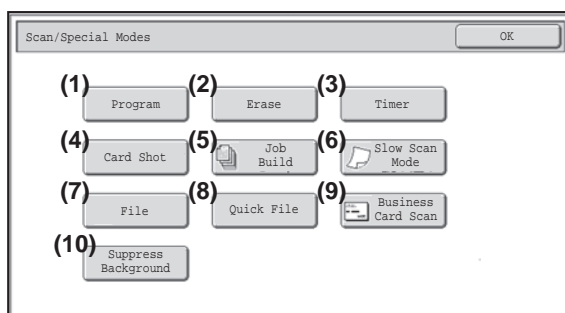

MX-B402SC:

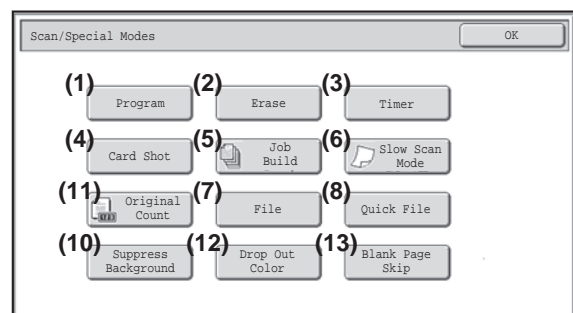

**(1) [Program] key\*1, 2**

 [STORING SCAN OPERATIONS \(Programs\)](#) (page 5-76)

**(2) [Erase] key**

 [ERASING PERIPHERAL SHADOWS ON THE IMAGE \(Erase\)](#) (page 5-78)

**(3) [Timer] key\*1**

 [SENDING AN IMAGE AT A SPECIFIED TIME \(Timer Transmission\)](#) (page 5-81)

**(4) [Card Shot] key**

 [SCANNING BOTH SIDES OF A CARD ONTO A SINGLE PAGE \(Card Shot\)](#) (page 5-83)

**(5) [Job Build] key**

 [SCANNING MANY ORIGINALS AT ONCE \(Job Build\)](#) (page 5-86)

**(6) [Slow Scan Mode] key**

 [SCANNING THIN ORIGINALS \(Slow Scan Mode\)](#) (page 5-88)

**(7) [File] key\*1**

Touch this key to use the File function of document filing mode.

**(8) [Quick File] key\*1**

Touch this key to use the Quick File function of document filing mode.

**(9) [Business Card Scan] key\*3**

 [SCANNING BUSINESS CARDS \(Business Card Scan\)](#) (page 5-94)

**(10) [Suppress Background] key**

 [WHITENING FAINT COLORS IN THE IMAGE \(Suppress Background\)](#) (page 5-97)

**(11) [Original Count] key**

 [CHECKING THE NUMBER OF SCANNED ORIGINAL SHEETS BEFORE TRANSMISSION \(Original Count\)](#) (page 5-90)

**(12) [Drop Out Color] key**

 [SCAN THE ORIGINAL DELETING THE COLORED PORTIONS \(Drop Out Color\)](#) (page 5-95)

**(13) [Blank Page Skip] key**

 [ELIMINATING BLANK PAGES FROM A TRANSMISSION \(Blank Page Skip\)](#) (page 5-92)

\*1 Does not appear in USB memory mode.

\*2 Does not appear in data entry mode.

\*3 B402 Only

The optional business card feeder must be attached and "Business Card Scan Option" must be enabled in the system settings (administrator).

## Internet fax mode

The keys explained below can only be used in Internet fax mode. The other keys are the same as those explained in "Scan mode, USB memory mode, Data entry mode" (page 5-74).

MX-B402:

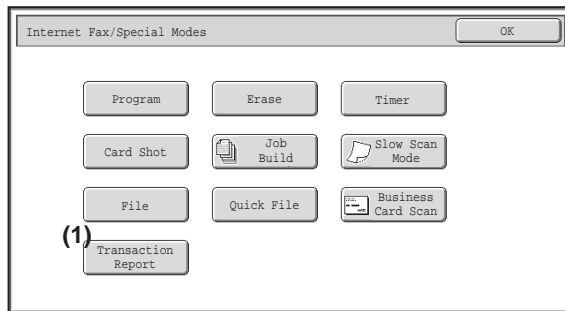

MX-B402SC:

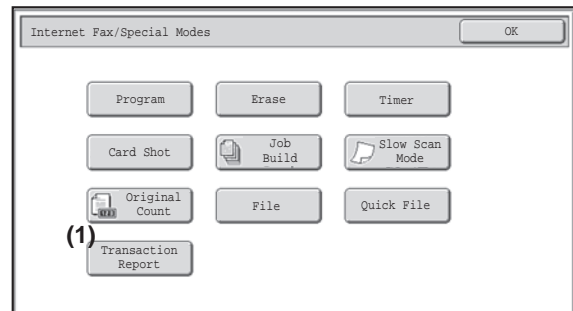

**(1) [Transaction Report] key**

[CHANGING THE PRINT SETTINGS FOR THE TRANSACTION REPORT \(Transaction Report\)](#)  
(page 5-99)



Special modes can generally be combined with other special modes, however, there are some combinations that are not possible. If a prohibited combination is selected, a message will appear in the touch panel.

## [OK] key and [Cancel] key

In some cases two [OK] keys and one [Cancel] key will appear in the special mode screens. The keys are used as follows:

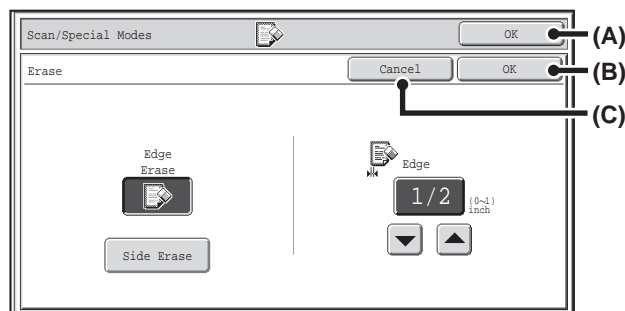

- (A) Enter the selected special mode setting and return to the base screen.
- (B) Enter the selected special mode setting and return to the special mode menu screen. Touch this key when you wish to continue selecting other special mode settings.
- (C) During selection of special mode settings, this key returns you to the special mode menu screen without saving the settings. When settings have been completed, this cancels the settings and returns you to the special mode menu screen.





# STORING SCAN OPERATIONS (Programs)

A destination, original settings, and functions can be stored in a program. When you wish to use those settings to send an image, they can be retrieved with ease.

For example, suppose 8-1/2" x 11" (A4) size documents are scanned into a file and sent to each branch office once a month.

(1) The same documents are sent to each branch office

(2) Smudges on the edges of the documents are erased before transmission

When a job program is not stored	When a job program is stored
Enter the address of each branch office.  Select Erase settings.  Press the [START] key. The originals are scanned and transmitted.	Touch a stored program key.  Press the [START] key. The originals are scanned and transmitted.
Considerable time is required to send the documents each month because the above settings must be selected. In addition, mistakes may occasionally be made when selecting the settings, so incorrect transmissions may occur.	When a program is used, settings are selected with ease by simply pressing the stored key. In addition, transmission takes place based on the stored settings so there are no chances for mistakes.



- Programs are stored, edited, and deleted using "Address Control" in the system settings. See "Program" (page 7-23) in "7. SYSTEM SETTINGS".
- Programs can also be stored in the Web pages. Click [Job Programs] and then [Image Send] in the Web page menu.
- The settings stored in a program will be retained even after the program is used for transmission. The same settings can be used repeatedly for transmission.
- The following settings can be stored in programs.
  - Image send mode: Scan, Internet fax
  - Destinations
  - Image settings: Original scan size, original orientation, duplex scanning, exposure, resolution
  - Special modes: Erase, Suppress Background, Job Build, Slow Scan Mode, Business Card Scan
- Up to 48 programs can be stored.
- Up to 500 destinations can be stored in one program.
- This function cannot be used in USB memory mode or data entry mode.

## Place the original.

1

Place the original in the document feeder tray or on the document glass as appropriate for the functions stored in the program. When the original is a different size than the size setting, set the original size.

 [SPECIFYING THE ORIGINAL SCAN SIZE AND SEND SIZE](#) (page 5-56)

## Select the special modes.

2

- (1) Touch the [Special Modes] key.
- (2) Touch the [Program] key.

 [SPECIAL MODES](#) (page 5-74)

3

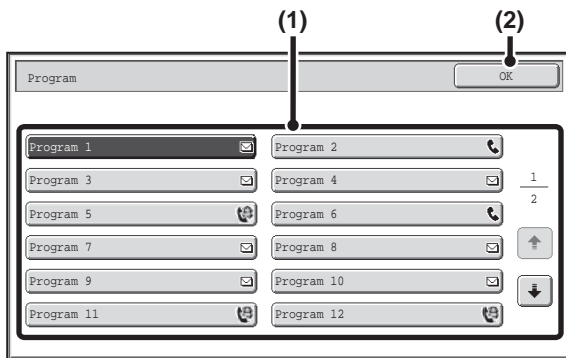

## Retrieve the stored program.

- (1) Touch the desired program key.
- (2) Touch the [OK] key.

4

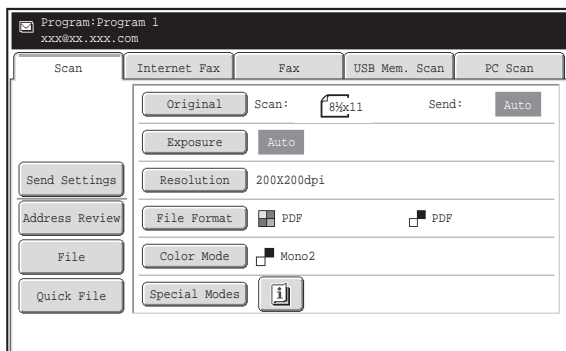

## Select additional settings.

When a program is used, the following settings can be additionally specified:

- Image Settings: Original scan size\*, send size, file format, color mode
- Send settings
- Special modes: Timer Transmission, Card Shot, File, Quick File, Transaction Report

\* When stored in the program, this cannot be additionally specified.



- The screen that appears will vary depending on the destination stored in the program.
- The mode cannot be changed here.
- Functions stored in the program cannot be canceled here.

5

## Press the [START] key.

Scanning begins.

- If you inserted the original pages in the document feeder tray, all pages are scanned. A beep will sound to indicate that scanning is finished.
- If you are scanning the original on the document glass, scan each page one page at a time. When scanning finishes, place the next original and press the [START] key. Repeat until all pages have been scanned and then touch the [Read-End] key. A beep will sound to indicate that scanning is finished.



### To cancel scanning...

Press the [STOP] key () to cancel the operation.

# ERASING PERIPHERAL SHADOWS ON THE IMAGE (Erase)

The erase function is used to erase shadows on images produced when scanning thick originals or books. (This function does not detect shadows and will eliminate everything appearing in the erase area - including shadows, text and images.)

## Scanning a thick book

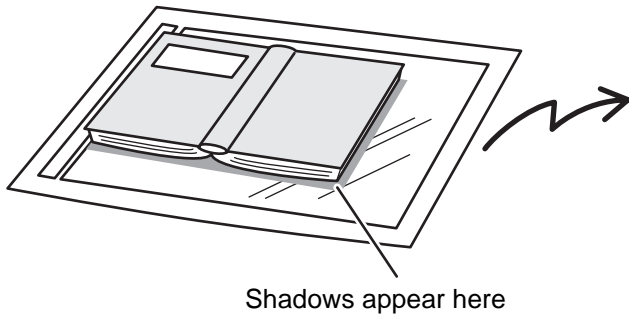

Not using the erase function	Using the erase function
<p>Shadows appear in the image.</p>	<p>No shadows appear.</p>

## Erase modes



- Shadows at the edges of the original can also be erased when the automatic document feeder is used.
- When using USB memory mode, connect the USB memory device to the machine before performing the procedure below.

### 1 Place the original.

Place the original face up in the document feeder tray, or face down on the document glass.

➤ [PLACING THE ORIGINAL](#) (page 1-37)

When the original is a different size than the size setting, set the original size.

➤ [SPECIFYING THE ORIGINAL SCAN SIZE AND SEND SIZE](#) (page 5-56)

### 2 Specify the destination.

➤ [ENTERING DESTINATIONS](#) (page 5-18)

➤ When scanning to USB memory, there is no need to specify the destination. Go to step 3.

**Select the special modes.****3**

- (1) Touch the tab of the mode that you wish to use.
- (2) Touch the [Special Modes] key.
- (3) Touch the [Erase] key.

 [SPECIAL MODES](#) (page 5-74)

4

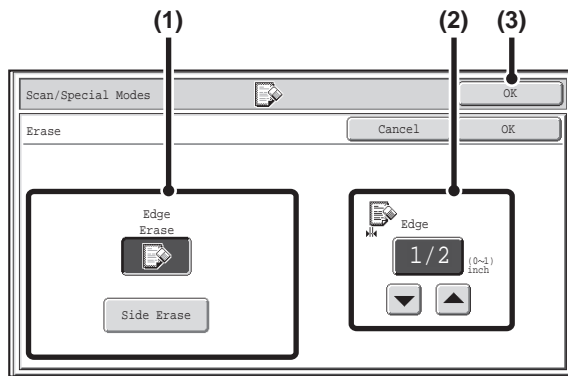

## Select the erase settings.

### (1) Touch the desired erase mode.

Select one of the 2 erase modes.

Touch the [Side Erase] key to open the following screen.

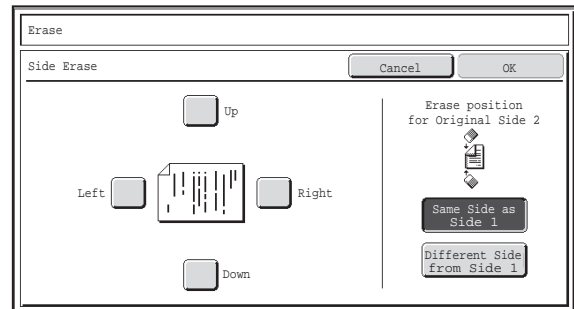

Touch the checkbox of the edge that you wish to erase and make sure that a checkmark () appears.

When performing two-sided scanning, set the erase edge on the reverse side.

- If you touch the [Same Side as Side 1] key, the edge in the same position as on the front side will be erased.
- If you touch the [Different Side from Side 1], the edge in the position opposite to the erased edge on the front side will be erased.

When you have completed the settings, touch the [OK] key.

### (2) Set the erasure width with the keys.

0" to 1" (0 mm to 20 mm) can be entered.

### (3) Touch the [OK] key.

5

## Press the [START] key.

Scanning begins.

- If you inserted the original pages in the document feeder tray, all pages are scanned. A beep will sound to indicate that scanning is finished.
- If you are scanning the original on the document glass, scan each page one page at a time. When scanning of one page finishes, replace it with the next page and press the [START] key. Repeat until all pages have been scanned and then press the [Read-End] key. A beep will sound to indicate that scanning is finished.



### To cancel scanning...

Press the [STOP] key () to cancel the operation.



When the erase function is used, erase takes place at the edges of the original image. If you also use a reduction or an enlargement setting, the erase width will change according to the selected ratio. For example, if the erase width setting is 1" (20 mm) and the image is reduced to 50%, the erase width will be 1/2" (10 mm).



### To cancel the erase setting...

Touch the [Cancel] key in the screen of step 4.



### System Settings (Administrator): Erase Width Adjustment

The default erase width setting is linked to the copy mode system setting, and can be set from 0" to 1" (0 mm to 20 mm). The factory default setting is 1/2" (10 mm).

# SENDING AN IMAGE AT A SPECIFIED TIME (Timer Transmission)

This function lets you specify a time at which a transmission or broadcast transmission will automatically take place. Transmission begins automatically at the specified time.

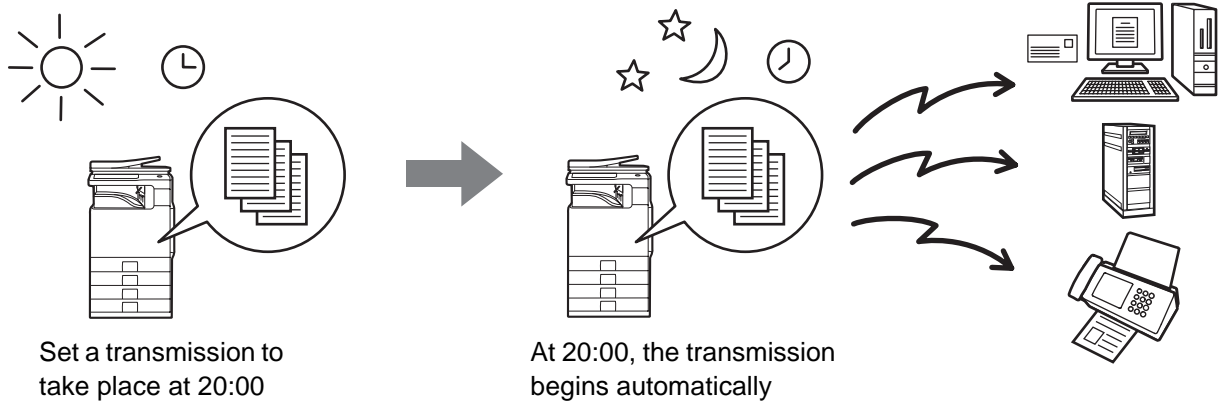

- When a timer transmission is stored, keep the main power switch in the "on" position. If the main power switch is in the "off" position at the specified time, transmission will not take place.
- When performing a timer transmission, you must scan the original into memory when you set up the transmission. It is not possible to leave the document in the auto document feeder or on the document glass and have it scanned at the specified time of transmission.
- Settings selected for a timer transmission (exposure, resolution, special modes, etc.) are automatically cleared after the transmission is finished. (However, when the document filing function is used, the scanned original and settings are stored on the built-in hard drive.)
- This function cannot be used in USB memory mode.

## 1 Place the original.

- Place the original face up in the document feeder tray, or face down on the document glass.  
When the original is a different size than the size setting, set the original size.  
☞ [SPECIFYING THE ORIGINAL SCAN SIZE AND SEND SIZE](#) (page 5-56)

## 2 Specify the destination.

- ☞ [ENTERING DESTINATIONS](#) (page 5-18)

## 3 Select the special modes.

- (1) Touch the tab of the mode that you wish to use.
  - (2) Touch the [Special Modes] key.
  - (3) Touch the [Timer] key.
- ☞ [SPECIAL MODES](#) (page 5-74)

4

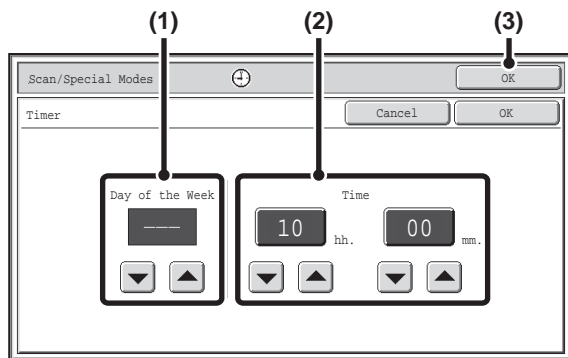

Set the time with the   keys.

**(1) Specify the day.**

If you do not wish to specify a day, select [--]. In this case, transmission will begin when the time specified in (2) arrives.

**(2) Specify the time (hour, minute)**

Select the time in 24-hour format.

You can also directly touch a numeric display key to change the setting with the numeric keys.

**(3) Touch the [OK] key.**



When this screen is opened, the setting will show the current time. If the time is not correct, press the [CLEAR ALL] key (CA) to cancel the operation. Correct the time in the system settings and then perform the timer transmission procedure.

 [CHECKING THE DATE AND TIME](#) (page 5-5)

5

## Press the [START] key.

Scanning begins.

- If you inserted the original pages in the document feeder tray, all pages are scanned. A beep will sound to indicate that scanning is finished.
- If you are scanning the original on the document glass, scan each page one page at a time. When scanning finishes, place the next original and press the [START] key. Repeat until all pages have been scanned and then touch the [Read-End] key. A beep will sound to indicate that scanning is finished.



The original is scanned into memory. The original cannot be scanned at a specified time.



**To cancel scanning...**

Press the [STOP] key (⏹) to cancel the operation.



- The time can be specified up to a week in advance.
- Up to 94 timer transmissions can be stored at once.
- If another transmission is in progress when the specified time arrives, the timer transmission will begin after that transmission is finished.
- Other transmissions can be performed as usual after a timer transmission is stored.
- A timer transmission can be deleted in the job status screen.
- If a timer transmission is given priority in the job status screen, the time specification is canceled. The transmission will begin as soon as the job in progress is completed.

 [GIVING PRIORITY TO A SCAN TRANSMISSION JOB](#) (page 5-108)



**To cancel timer transmission...**

Touch the [Cancel] key in the screen of step 4.

# SCANNING BOTH SIDES OF A CARD ONTO A SINGLE PAGE (Card Shot)

This function lets you send the front and reverse sides of a card as a single page, without the need to send each side separately.

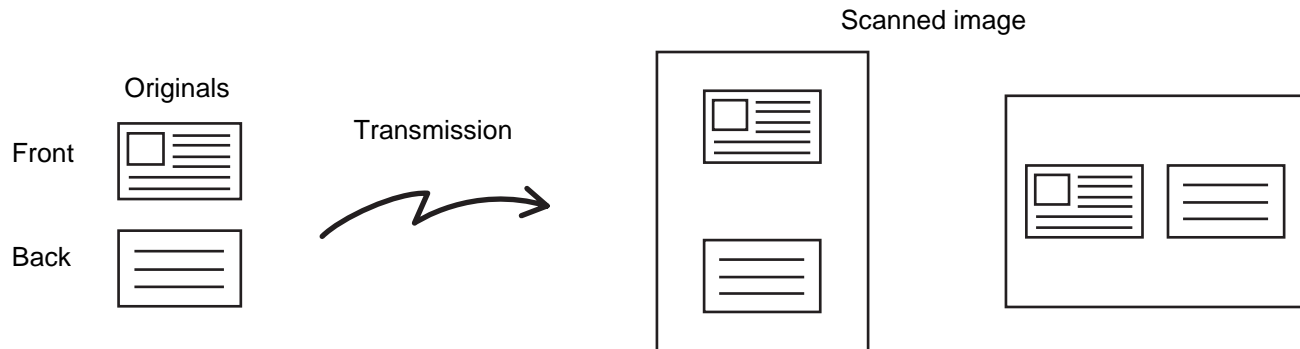

- When using USB memory mode, connect the USB memory device to the machine before performing the procedure below.
- Depending on the card type, some cards cannot be used with the automatic document feeder.

MX-B402:

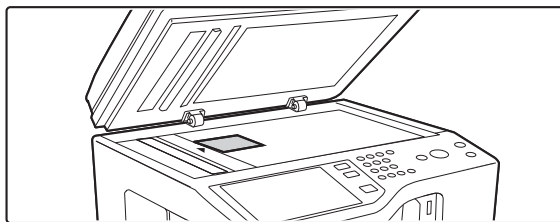

**MX-B402:**

Place the original face down on the document glass.

1

MX-B402SC:

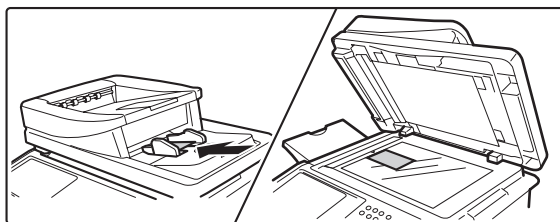

**MX-B402SC:**

Place the original face up in the document feeder tray, or face down on the document glass.

When the original is a different size than the size setting, set the original size.

➤ [SPECIFYING THE ORIGINAL SCAN SIZE AND SEND SIZE](#) (page 5-56)

## Specify the destination.

➤ [ENTERING DESTINATIONS](#) (page 5-18)

2



When scanning to USB memory, there is no need to specify the destination. Go to step 3.



### Select the special modes.

3

- (1) Touch the tab of the mode that you wish to use.
- (2) Touch the [Special Modes] key.
- (3) Touch the [Card Shot] key.

 [SPECIAL MODES](#) (page 5-74)

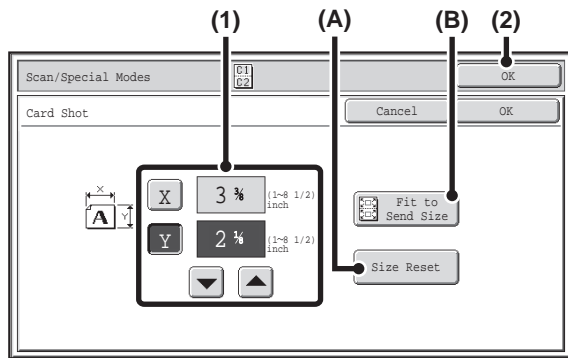

### Specify the original size.

#### (1) Enter the original size.

- Touch the X (width) numeric value display key and enter the width.
- Touch the Y (height) numeric value display key and enter the height.



(A) To return the original size to the default size, touch the [Size Reset] key.

(B) To automatically enlarge or reduce the image to fit the send size, touch the [Fit to Send Size] key. If you wish to scan the original at the entered original size, there is no need to touch this key.

#### (2) Touch the [OK] key.

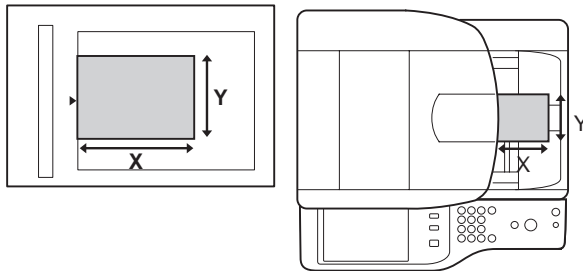
4



- You can also touch the   keys to change the number.
- The send size will be selected automatically based on the entered original size.
- After selecting Card Shot, you can touch the [Original] key in the base screen to change the original scan size or the send size. In this case, touch the [Scan Size] key to display the screen for this procedure. For the procedure for setting the send size, see "[Specifying the send size of the image](#)" (page 5-62).

### Press the [START] key to scan the front side of the card.

5



#### To cancel scanning...

Press the [STOP] key () to cancel the operation.

## 6 Turn the card over and press the [START] key to scan the reverse side of the card.

The back of the card will be scanned using the same color mode as the front.

6



Before scanning the back of the card, you can touch the [Configure] key in the touch panel to change the exposure.



### To cancel scanning...

Press the [STOP] key (⏹) to cancel the operation.

7

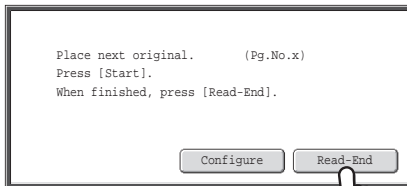

## Touch the [Read-End] key.



If you will continue scanning additional cards, you can touch the [Configure] key to change the exposure, resolution, scan size, and send size.



The ratio cannot be specified and "Rotation Sending Setting" cannot be selected.



### To cancel Card Shot...

Touch the [Cancel] key in the screen of step 4.

# SCANNING MANY ORIGINALS AT ONCE (Job Build)

This function lets you separate an original consisting of numerous pages into sets, scan each set using the automatic document feeder, and transmit the pages in a single transmission. Use this function when the number of originals that you wish to scan exceeds the maximum number of sheets that can be inserted in the automatic document feeder at once.

When scanning originals that are separated into sets, scan the set that has the first page first. The settings that you select for the first set can be used for all remaining sets.

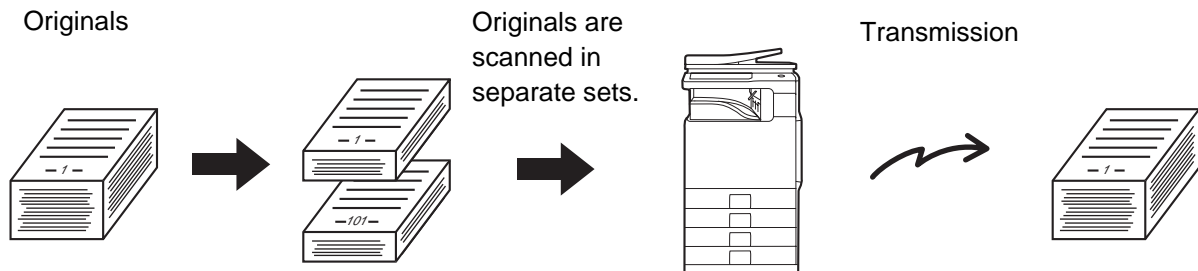

- Up to 999 pages can be scanned. Note that when the memory is being used for other jobs, fewer pages can be scanned.
- When using USB memory mode, connect the USB memory device to the machine before performing the procedure below.

## MX-B402:

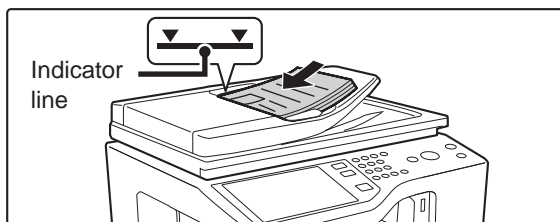

1

## MX-B402SC:

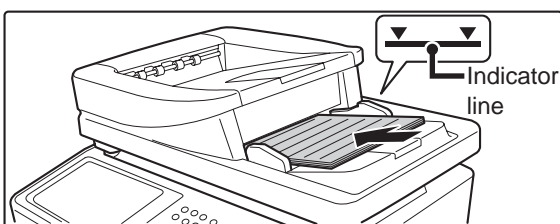

## Insert the originals face up in the document feeder tray.

Insert the originals all the way into the document feeder tray. Multiple originals can be placed in the document feeder tray. The stack of originals must not be higher than the indicator line on the tray.

When the original is a different size than the size setting, set the original size.

➤ [SPECIFYING THE ORIGINAL SCAN SIZE AND SEND SIZE](#) (page 5-56)

## Specify the destination.

➤ [ENTERING DESTINATIONS](#) (page 5-18)

2



When scanning to USB memory, there is no need to specify the destination. Go to step 3.

### Select the special modes.

3

- (1) Touch the tab of the mode that you wish to use.
- (2) Touch the [Special Modes] key.

 [SPECIAL MODES](#) (page 5-74)

4

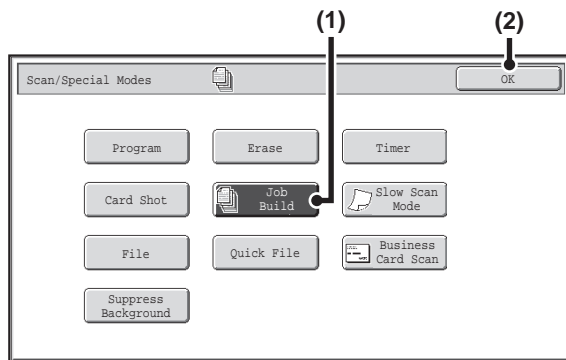



### Select job build mode.

- (1) Touch the [Job Build] key so that it is highlighted.
- (2) Touch the [OK] key.

5



### Press the [START] key to scan the first set of originals.

 **To cancel scanning...**  
Press the [STOP] key () to cancel the operation.

6

### Insert the next set of originals and press the [START] key.

Repeat until all originals have been scanned.

 **To cancel scanning...**  
Press the [STOP] key () to cancel the operation. All scanned data will be cleared.

7

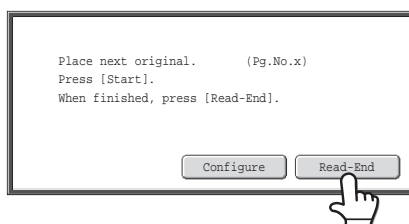

### Touch the [Read-End] key.

-  • If no action is taken for one minute after the confirmation screen appears, scanning automatically ends and the transmission is reserved.
- The [Configure] key can be touched to change the exposure, resolution, scan size, and send size for each original page scanned.



If the memory becomes full during scanning, a message will appear and the transmission will be canceled.



**To cancel the job build function....**  
Touch the [Job Build] key in the screen of step 4 so that it is not highlighted.

# SCANNING THIN ORIGINALS (Slow Scan Mode)

Use this function when you wish to scan thin originals using the automatic document feeder. This function helps prevent thin originals from misfeeding.

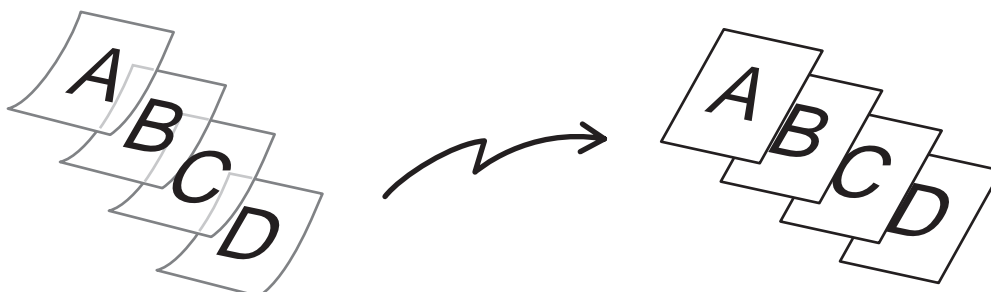

 When using USB memory mode, connect the USB memory device to the machine before performing the procedure below.

## MX-B402:

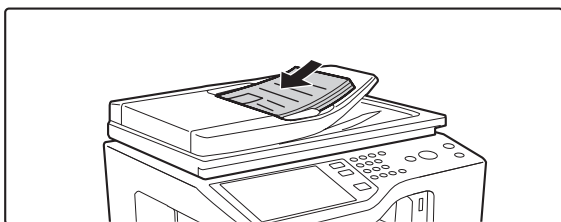

## Insert the originals face up in the document feeder tray.

Adjust the original guides slowly.  
When the original is a different size than the size setting, set the original size.

 [SPECIFYING THE ORIGINAL SCAN SIZE AND SEND SIZE](#) (page 5-56)

## MX-B402SC:

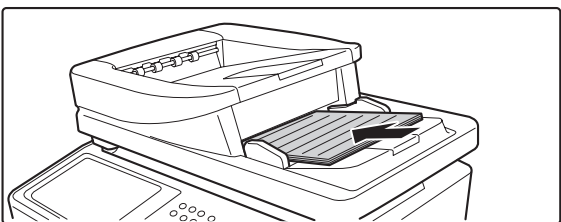

1

 If the originals are inserted with too much force, they may crumple and misfeed.

## Specify the destination.

 [ENTERING DESTINATIONS](#) (page 5-18)

2

 When scanning to USB memory, there is no need to specify the destination. Go to step 3.

### Select the special modes.

3

- (1) Touch the tab of the mode that you wish to use.
- (2) Touch the [Special Modes] key.

 [SPECIAL MODES](#) (page 5-74)

4

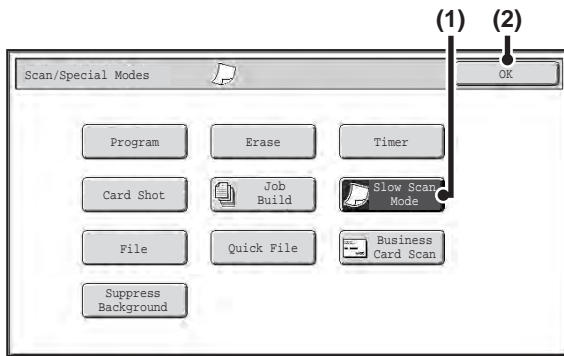

### Select slow scan mode.

- (1) Touch the [Slow Scan Mode] key so that it is highlighted.
- (2) Touch the [OK] key.

### Press the [START] key.

Scanning begins. A beep will sound to indicate that scanning is finished.

5



#### To cancel scanning...

Press the [STOP] key () to cancel the operation.



When this function is selected, automatic 2-sided scanning is not possible.



#### To cancel slow scan mode...

Touch the [Slow Scan Mode] key in the screen of step 4 so that it is not highlighted.



#### System Settings (Administrator): Original Feeding Mode

This is used to have scanning always take place in slow scan mode.

# CHECKING THE NUMBER OF SCANNED ORIGINAL SHEETS BEFORE TRANSMISSION (Original Count)

## MX-B402SC Only

The number of scanned original sheets can be counted and displayed before transmission. Checking the number of scanned original sheets before transmission helps prevent transmission mistakes.



- This function cannot be used in USB memory mode.
- The setting can be enabled separately for each mode.

### 1

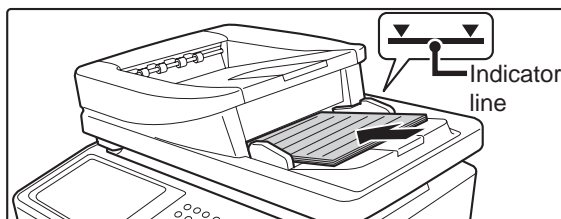

## Insert the originals face up in the document feeder tray.

Insert the originals all the way into the document feeder tray. Multiple originals can be placed in the document feeder tray. The stack of originals must not be higher than the indicator line on the tray.

### 2

## Specify the destination.

☞ [ENTERING DESTINATIONS](#) (page 5-18)

### 3

## Select the special modes.

(1) Touch the tab of the mode that you wish to use.

(2) Touch the [Special Modes] key.

☞ [SPECIAL MODES](#) (page 5-74)

### 4

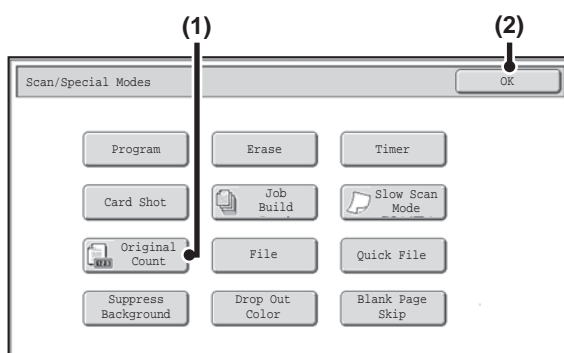

## Select the original count function.

(1) Touch the [Original Count] key so that it is highlighted.

(2) Touch the [OK] key.

5

## Press the [COLOR START] key or the [BLACK & WHITE START] key.

Scanning begins.



### To cancel scanning...

Press the [STOP] key (Ⓢ) to cancel the operation. All scanned data will be cleared.

6

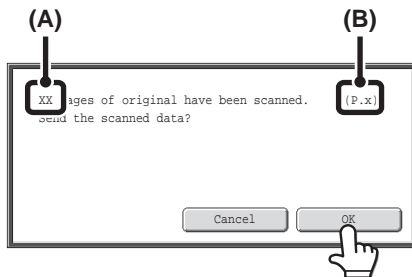

## When scanning ends, check the number of original sheets scanned and touch the [OK] key.

Transmission will begin.

- When Job Build mode is used, the confirmation message will appear after the [Read-End] key is touched.
- The message on the screen shows the number of sheets scanned in (A), and the number of pages (sheet sides) scanned in (B). For example, if both sides of one original sheet are scanned, "1" will appear in (A) and "2" will appear in (B).



If this step is not performed for one minute while the above confirmation screen appears, the scanned image and settings will be cleared and the base screen will reappear. Scanning will not be completed automatically and the image will not be reserved for transmission.



### If the displayed number of original sheets is different from the actual number of sheets...

Touch the [Cancel] key and then touch the [OK] key in the message screen to clear all scanned data. Scan settings and destination settings will not be cleared. Insert the original sheets in the automatic document feeder again and press the [START] key to re-scan.



When a broadcast transmission is performed, if the original count function is selected in any of the modes, the function will operate for all destinations.



### To cancel the Original Sheet Count function...

Touch the [Original Count] key in the screen of step 4 so that it is no longer highlighted.



### System Settings (Administrator): Initial Original Count Setting

This can be enabled to have the number of original sheets always counted. The setting can be enabled separately for each mode.



# ELIMINATING BLANK PAGES FROM A TRANSMISSION (Blank Page Skip)

MX-B402SC Only

When blank pages are included in originals scanned using the automatic document feeder, the blank pages can be detected and automatically eliminated from transmission.

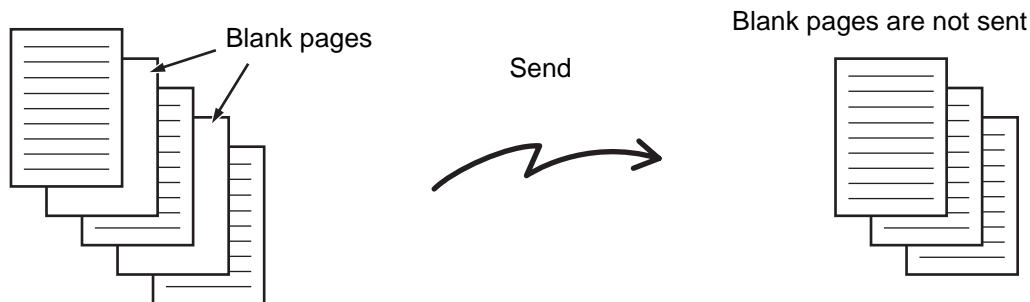

- This function cannot be used in Internet fax mode.
- Depending on the original, some pages that are not blank may be detected as blank pages and thus not sent, and some pages that are blank may not be detected as blank and thus sent.
- When using USB memory mode, connect the USB memory device to the machine before performing the procedure below.

1

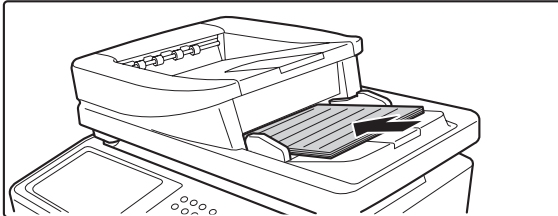

## Insert the originals face up in the document feeder tray.

This function cannot be used when the document glass is used for scan send.

2

## Specify the destination.



☞ [ENTERING DESTINATIONS](#) (page 5-18)



When scanning to USB memory, there is no need to specify the destination. Go to step 3.

3

## Select the special modes.

- (1) Touch the tab of the mode that you wish to use.
- (2) Touch the [Special Modes] key.
- (3) Touch the   keys to switch through the screens.
- (4) Touch the [Blank Page Skip] key.

☞ [SPECIAL MODES](#) (page 5-74)

4

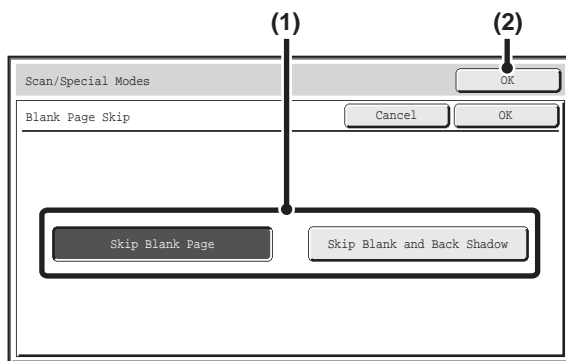

## Set blank page skipping.

### (1) Select the type of blank page to be skipped.

Select from two types.

To include blank pages on which the content on the opposite side shows through, touch [Skip Blank and Back Shadow].

### (2) Touch the [OK] key.

5

## Press the [COLOR START] key or the [BLACK & WHITE START] key.

Scanning begins. A beep will sound to indicate that scanning is finished.

### To cancel scanning...

Press the [STOP] key (⏹) to cancel the operation.

6

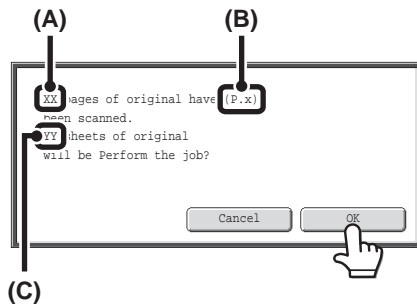

## When scanning is completed, check the number of original sheets and the number of sheets to be sent, and touch [OK].

Scanning begins.

- When Job Build mode is used, the confirmation message will appear after the [Read-End] key is touched.
- The number of scanned original sheets appears in (A), the number of scanned sides in (B), and the number of sheets to be sent excluding blank pages in (C). For example, if five original sheets that include two blank pages are scanned by duplex scanning, (A) will show "5", (B) will show "10", and (C) will show "8".



If this step is not performed for one minute while the above confirmation screen appears, the scanned image and settings will be cleared and the base screen will reappear. Scanning will not be completed automatically and the image will not be reserved for transmission.

When "Default Preview" is enabled in the system settings (administrator) and the skip blank pages function is used to scan original pages, you can check the pages, including the blank pages, in the preview screen. For more information, see "[PREVIEW CHECK SCREEN](#)" (page 5-73).

**To cancel the Blank Page Skip function...**  
Touch the [Cancel] key in the screen of step 4 so that it is no longer highlighted.

**System settings (administrator): Original Feeding Mode**  
Use this setting to always skip blank pages when sending.

# SCANNING BUSINESS CARDS (Business Card Scan)

**MX-B402 Only**

Multiple business cards can be scanned and transmitted at once.

To use this function, the business card feeder must be attached to the automatic document feeder and "Business Card Scan Option" must be enabled in the system settings (administrator). For the attachment procedure, see "[BUSINESS CARD FEEDER](#)" in "BEFORE USING THE MACHINE" (page 1-47).



Depending on the card type, some cards cannot be used with the automatic document feeder.

**1**

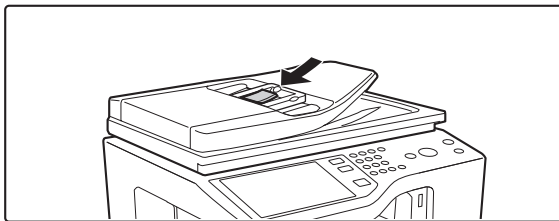

**Load the business cards.**

**2**

**Specify the destination.**

[ENTERING DESTINATIONS](#) (page 5-18)

**3**

**Select the special modes.**

(1) Touch the tab of the mode that you wish to use.

(2) Touch the [Special Modes] key.

(3) Touch the [Business Card Scan] key.

Read the message that appears and then touch the [OK] key.

[SPECIAL MODES](#) (page 5-74)

**4**

**Press the [START] key.**

Scanning begins. A beep will sound to indicate that scanning is finished.



**To cancel scanning...**

Press the [STOP] key () to cancel the operation.



This function cannot be used when the scan size is specified by numerical values.



**System Settings (Administrator): Business Card Scan Option**

Specify whether or not the Business Card Scan function is used.

# SCAN THE ORIGINAL DELETING THE COLORED PORTIONS (Drop Out Color)

**MX-B402SC Only**

The original's colored portions (portions other than black) can be erased.

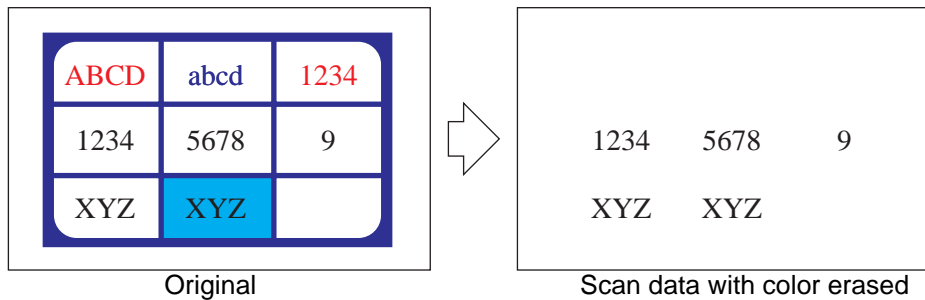

- This feature can only be used when set to [Mono2] in [Color Mode].
- When this function is selected, the "Original Image Type" setting for exposure adjustment automatically changes to "Text".
- This function cannot be used in Internet fax mode.

**1**

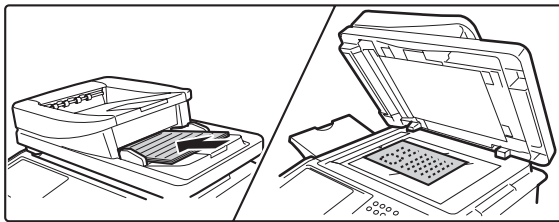

## Place the original.

Place the original face up in the document feeder tray, or face down on document glass.

➤ [PLACING THE ORIGINAL](#) (page 1-37)

When the original is a different size than setting, set the original size.

➤ [PLACING THE ORIGINAL](#) (page 1-37)

**2**

## Specify the destination.

➤ [ENTERING DESTINATIONS](#) (page 5-18)

**3**

## Select the special modes.

- (1) Touch the tab of the mode that you wish to use.
- (2) Touch the [Special Modes] key.
- (3) [SPECIAL MODES](#) (page 5-74)

4

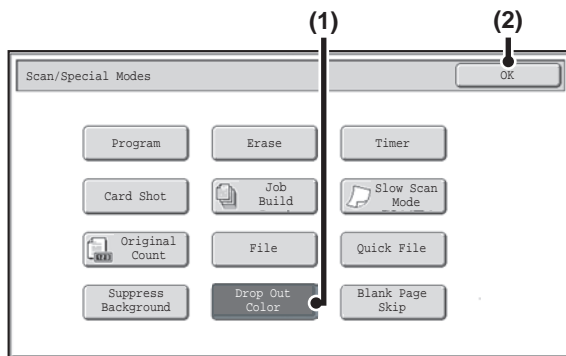

### Select drop out color mode.

- (1) Touch [Drop Out Color] key so that it is highlighted.
- (2) Touch the [OK] key.

5

### Pless the [START] key.

Scanning begins.

- If you inserted the original pages in the document feeder tray, all pages are scanned. A beep will sound to indicate that scanning is finished.
- If you are scanning finishes, place the next original and press the [START] key. Repeat until all pages have been scanned and then touch the [Read-End] key. A beep will sound to indicate that scanning is finished.



#### To cancel scanning...

Press the [STOP] key (⏏) to cancel the operation.



#### To cancel the Drop Out Color fuction....

Touch the [Drop Out Color] key in the screen of step 4 so that it is not highlighted.

# WHITENING FAINT COLORS IN THE IMAGE (Suppress Background)

This feature is used to suppress light background areas.

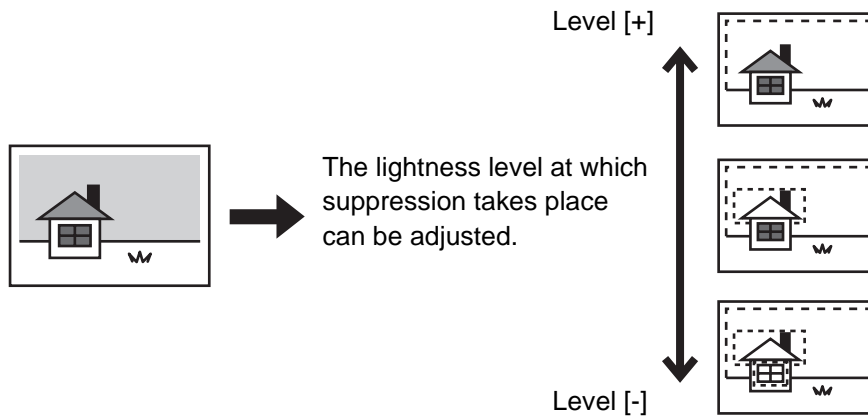

- This function cannot be used in Internet fax mode.
- When using USB memory mode, connect the USB memory device to the machine before performing the procedure below.

## 1 Place the original.

- Place the original face up in the document feeder tray, or face down on the document glass.  
When the original is a different size than the size setting, set the original size.  
☞ [SPECIFYING THE ORIGINAL SCAN SIZE AND SEND SIZE](#) (page 5-56)

## 2 Specify the destination.

- ☞ [ENTERING DESTINATIONS](#) (page 5-18)

- ☞ When scanning to USB memory, there is no need to specify the destination. Go to step 3.

## 3 Select the special modes.

- (1) Touch the tab of the mode that you wish to use.
- (2) Touch the [Special Modes] key.
- (3) Touch the [Suppress Background] key.

Read the message that appears and then touch the [OK] key.

- ☞ [SPECIAL MODES](#) (page 5-74)

4

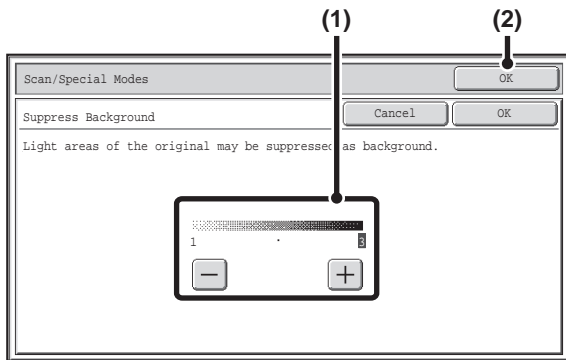

### Select the suppress background setting.

#### (1) Adjust the background suppression level.

Touch the [+] key to suppress only faint background.  
Touch the [-] key to suppress faint to dark background.

#### (2) Touch the [OK] key.

5

### Press the [START] key.

Scanning begins.

- If you inserted the original pages in the document feeder tray, all pages are scanned. A beep will sound to indicate that scanning is finished.
- If you are scanning the original on the document glass, scan each page one page at a time. When scanning finishes, place the next original and press the [START] key. Repeat until all pages have been scanned and then touch the [Read-End] key. A beep will sound to indicate that scanning is finished.



When the original is scanned in [Mono2], the suppress background function will not operate.



#### To cancel scanning...

Press the [STOP] key (⏹) to cancel the operation.



#### To cancel the background suppression setting...

Touch the [Cancel] key in the screen of step 4.

---

---

# CHANGING THE PRINT SETTINGS FOR THE TRANSACTION REPORT (Transaction Report)

A transaction report is automatically printed out to alert you when an Internet fax transmission fails or when a broadcast transmission is performed. The transaction report contains a description of the transmission (date, start time, name of other party, time required, number of pages, result, etc.).

 [INFORMATION APPEARING IN THE RESULT COLUMN](#) (page 5-109)



This function cannot be used in scan mode, USB memory mode, or data entry mode.

Transaction reports are printed based on conditions set in the system settings; however, you can temporarily select different conditions for a transmission. To change the transaction report print conditions at the time of transmission, follow the steps below.

## 1 Place the original.

Place the original face up in the document feeder tray, or face down on the document glass.

 [PLACING THE ORIGINAL](#) (page 1-37)

When the original is a different size than the size setting, set the original size.

 [SPECIFYING THE ORIGINAL SCAN SIZE AND SEND SIZE](#) (page 5-56)

## 2

## Specify the destination.

 [ENTERING DESTINATIONS](#) (page 5-18)

## 3

## Select the special modes.

(1) Touch the [Internet Fax] tab.

(2) Touch the [Special Modes] key.

(3) Touch the [Transaction Report] key.

 [SPECIAL MODES](#) (page 5-74)



4

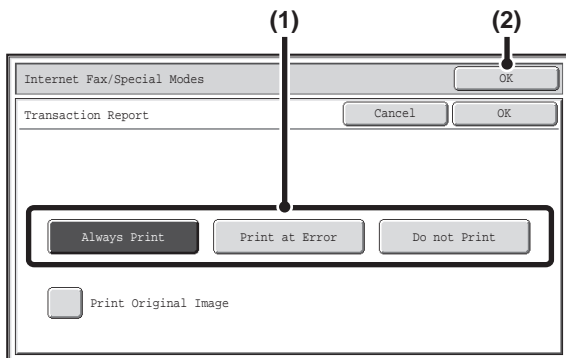

### Select print conditions.

- (1) Select the print conditions.
- (2) Touch the [OK] key.



- The print conditions for a transaction report are as follows:
  - "Always Print": A transaction report is printed no matter whether the transmission succeeds or fails.
  - "Print at Error": A transaction report is printed when transmission fails.
  - "Do not Print": Do not print a transaction report.
- When the [Print Original Image] checkbox is selected , part of the transmitted original is included on the transaction report.

5

### Press the [START] key.

Scanning begins.

- If you inserted the original pages in the document feeder tray, all pages are scanned. A beep will sound to indicate that scanning is finished.
- If you are scanning the original on the document glass, scan each page one page at a time. When scanning finishes, place the next original and press the [START] key. Repeat until all pages have been scanned and then touch the [Read-End] key. A beep will sound to indicate that scanning is finished.



#### To cancel scanning...

Press the [STOP] key (⏹) to cancel the operation.



For a broadcast transmission, changes to the transaction report print conditions apply to all destinations.



#### To cancel the transaction report setting...

Touch the [Cancel] key in the screen of step 4.



#### • System Settings (Administrator): Transaction Report Print Select Setting

This is used to set the conditions for printing transaction reports.

The factory default setting is .

Single Sending: /Print Out Error Report Only/No Printed Report

Broadcasting: /Print Out Error Report Only/No Printed Report

Receiving: /Print Out Error Report Only/No Printed Report

#### • System Settings (Administrator): Original Print on Transaction Report

This is used to have part of the transmitted original printed on the transaction report.

# CHECKING THE STATUS OF TRANSMISSION/RECEPTION JOBS

This section explains how to check the status of reserved transmission jobs and received Internet faxes.

## JOB STATUS SCREEN

The job status screen is displayed when the [JOB STATUS] key on the operation panel is pressed. The job status screen shows the status of jobs by mode. When the [JOB STATUS] key is pressed, the job status screen of the mode that was being used before the key was pressed appears.

Reserved transmissions and received Internet faxes are referred to as jobs.

### Example: Pressing the tab in scan mode

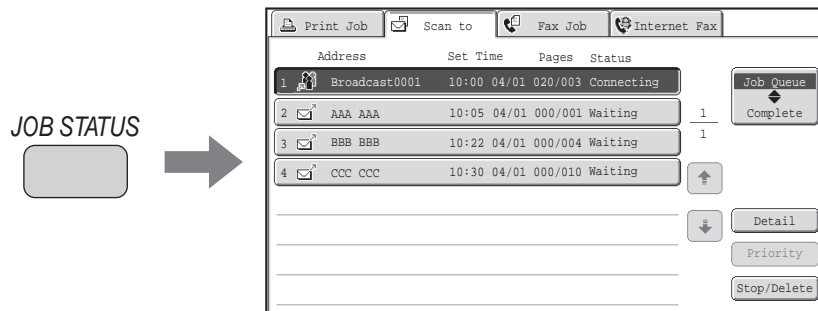

The job status display is in the lower left corner of the touch panel. The job status display can be touched to display the job status screen.

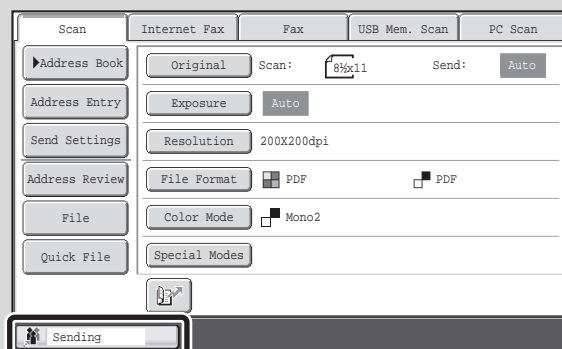

# JOB QUEUE SCREEN AND COMPLETED JOB SCREEN

The job status screen consists of two screens: the job queue screen that shows reserved jobs and the job currently in progress, and the completed jobs screen. To switch between the two screens, touch the job status screen selector key ((2) below).

## Job queue screen

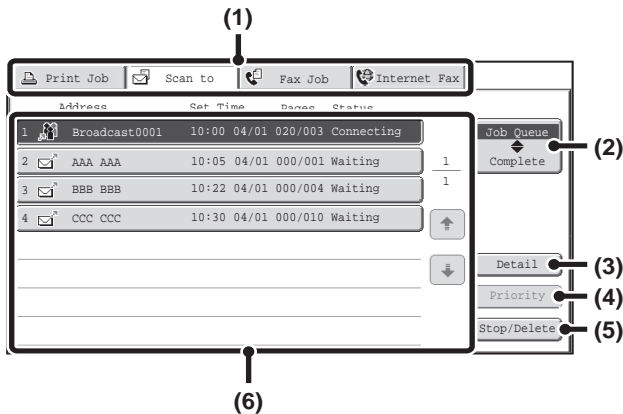

## Complete screen

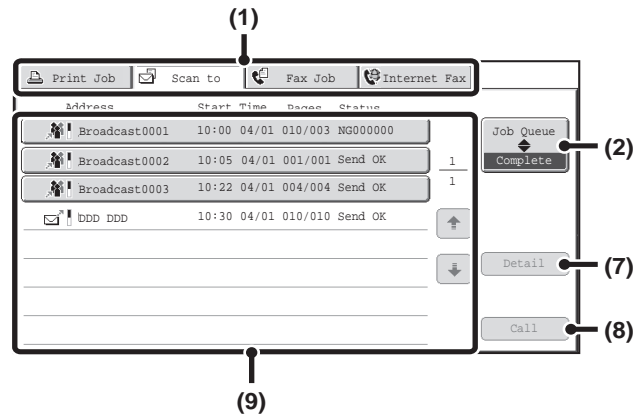

### (1) Mode switch tabs

Use these tabs to change the job status screen mode.

### (2) Job status screen selector key

Touch this key to switch between the job queue screen and the completed jobs screen.

### (3) Job queue screen [Detail] key

This shows detailed information on broadcast transmission jobs and the status of jobs. Select the key of the desired job in the job queue screen (6) and then touch the [Detail] key.

### (4) [Priority] key

Touch this key to give priority to a selected job.  
[GIVING PRIORITY TO A SCAN TRANSMISSION JOB](#) (page 5-108)

### (5) [Stop/Delete] key

Touch this key to stop or delete a selected job.  
[STOPPING A SCAN JOB BEING TRANSMITTED OR WAITING TO BE TRANSMITTED](#) (page 5-107)

### (6) Job queue screen

Jobs are shown as keys in the order they were reserved. Each key shows information on the job and its current status.

[Job key display](#) (page 5-103)

### (7) Completed jobs screen [Detail] key

This shows detailed information on the results of completed broadcast transmissions and jobs that used the document filing function. Select the key of the desired job in the completed jobs screen (9) and then touch the [Detail] key.

[CHECKING COMPLETED JOBS](#) (page 5-106)

### (8) [Call] key

Touch this key to call up and use a transmission or reception job stored with the document filing function.

### (9) Completed jobs screen

This shows up to 99 completed transmission or reception jobs in each mode. A description of the job and the result (status) are shown.

Jobs that used document filing function, broadcast transmission jobs, and received Internet fax forwarding jobs are indicated as keys.

## Job key display

The following information is shown in the job queue keys and completed job keys that appear in the job status screen. Direct SMTP information is also included in Internet fax transmission/reception information.

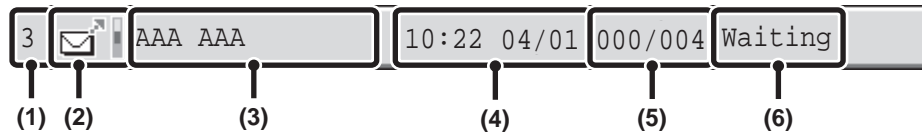

**(1) Displays the number (position) of the job in the job queue.**

When the job currently being transmitted is finished, the job moves up one position in the job queue. This number does not appear in keys in the completed jobs screen.

**(2) Mode icon**

This indicates the type of job. In the completed jobs screen, a color bar appears next to the icon to indicate whether the job was executed in color or black & white. (However, the color bar icon does not appear in the key of a job that used document filing or in the key of a transmission/reception job that was canceled.)

Icon	Job type
	Scan to E-mail
	Scan to FTP
	Scan to Network Folder
	Scan to Desktop
	Internet fax transmission
	Internet fax reception
	PC-I-Fax transmission
	Broadcast transmission or Inbound routing
	Metadata transmission

**(3) Name of communicating party (address)**

For a transmission, the name or address of the destination. For a reception, the address of the sending party. In the case of a broadcast transmission, "Broadcast" appears together with a broadcast control number (4-digits).

**(4) Time reserved/Time started**

In the job queue screen, the date and time the job was reserved. In the completed jobs screen, the date and time the job was started.

**(5) Number of pages**

Shows the number of pages transmitted/total number of original pages.

**(6) Status**

Shows the job status.

- Job in progress

Display	Status
"Connecting"	Connecting to the destination.
"Sending"	Sending data.
"Receiving"	Receiving an Internet fax.
"Stopped"	The job has been stopped.
"Error"	An error occurred while the job was being executed.

- Job waiting to be executed

Display	Status
"Waiting"	The job is waiting to be executed.
"Retry Mode"	The job is being re-attempted due to a communication error or other problem.
"Report Wait"	An Internet fax has been sent for which a receive report was requested, and the machine is waiting for the receive report.
A day and time is displayed	Timer transmission job (the specified time is displayed)

- Completed job

Display	Status
"Send OK"	Transmission was completed.
"In Memory"	An Internet fax has been received but has not yet been printed.
"Received"	A received Internet fax has been printed or deleted in the check image screen.
"Forward OK"	A received Internet fax has been forwarded.
"Stopped"	The job was stopped.
"Number of successful transmission destinations/ Total destinations OK"	Completion of a broadcast transmission or inbound routing operation. If transmission to 3 destinations was successful out of a total of 5, "003/005 OK" will appear.
"No Response"	An error occurred because there was no response from the destination.
"OK Report"	A receive report was requested for a transmission, the transmission was completed normally, and the receive report was received from the destination.
"NG Report"	A receive report was requested for a transmission, however, the transmission did not take place correctly and a transmission failed report was received.
"No Report"	An e-mail was received without an attached file and thus printing was not possible.
"Received"	An e-mail was received, however, the attached file was not a TIFF-F file or there was no attached file, and thus printing was not possible.
"Rejected"	An Internet fax was sent from a party that is blocked.
"NGxxxxxx"	Transmission/reception was not successful because a communication error occurred (a 6-digit error code appears in xxxxxx.)
"Error"	An error occurred while the job was being executed.

# OPERATION WHEN A JOB IN THE JOB QUEUE IS COMPLETED

When a normal transmission job is completed, it moves to the completed jobs screen and "Send OK" appears in the status column.

Received Internet faxes, timer transmission jobs, and forwarding jobs are handled in the job status screen as explained below.

## Internet fax reception jobs

While an Internet fax is being received, "Receiving" appears.

When reception is completed, the job moves to the completed jobs screen and "In Memory" appears.

When printing ends, the status changes to "Printed" and the job is completed.

## Timer transmission jobs

A timer transmission job appears at the bottom of the job queue until the specified time arrives.

When the specified time arrives, the job is executed. If another job is in progress, the timer job is started when the other job is completed.

## Internet fax transmission jobs that request a receive report

After completion of an Internet fax transmission job (excluding Direct SMTP transmission jobs) that requests a receive report, the job is placed on standby at the bottom of the job queue screen. "Report Wait" appears in the status column. When the receive report is received from the destination, or if the report is not received within the timeout time, the job moves to the completed jobs screen.

## Reception jobs when "Inbound Routing Settings" are enabled

When "Inbound Routing Settings" are enabled, reception jobs are handled as follows depending on the print setting.

 [FORWARDING RECEIVED INTERNET FAXES TO A NETWORK ADDRESS \(Inbound Routing Settings\)](#) (page 5-115)

- **Received Internet fax is not printed**

"Receiving" appears while the Internet fax is being received. When reception is completed, the job moves to the job queue of the job status screen of scan mode.

- **Received Internet fax is printed**

When reception is completed, the job moves to the completed jobs screen and "In Memory" appears. When printing ends, the status changes to "Printed" and the job is completed. In addition, the job is added to the job queue of the job status screen of scan mode. When forwarding received Internet faxes is finished, "Forward OK" appears.

## CHECKING COMPLETED JOBS

You can check a list of the destinations, the destinations for which transmission failed, and other detailed information on completed jobs that used document filing function, broadcast transmission jobs, and received Internet fax forwarding jobs. Touch the key of the job for which you wish to display information in the completed jobs screen and touch the [Detail] key. The job detail screen (see below) will appear.

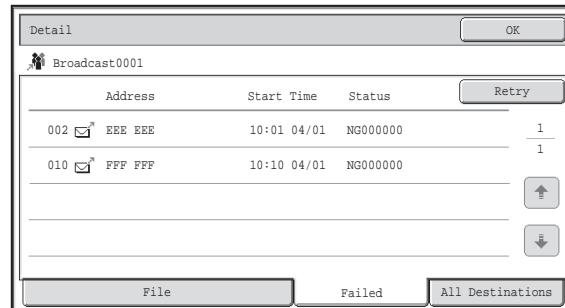

The job name appears at the top of the job detail screen.

To view details on the job, touch one of the tabs. The following information appears on each tab.

Tab name	Information displayed
File	Shows information on a transmission/reception that used document filing function. To call up the file and use it, touch the [Call] key.
Failed	Shows information on addresses for which communication failed. Address: Address name or number Start time: Time at which communication began. Status: Description of failure (error) The [Retry] key can be touched to re-attempt transmission to that address.*
All Destinations	Shows all addresses specified in the job. Address: Address name or number Start time: Time at which communication began. Status: Communication result The [Retry] key can be touched to transmit to all addresses again.*

\* Recalling is not possible for a broadcast transmission that includes a Scan to FTP address, Scan to Network Folder address, or Scan to Desktop address.

# STOPPING A SCAN JOB BEING TRANSMITTED OR WAITING TO BE TRANSMITTED

Follow the steps below to stop a job that is being transmitted or is waiting to be transmitted.

1

JOB STATUS

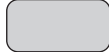

Press the [JOB STATUS] key.

2

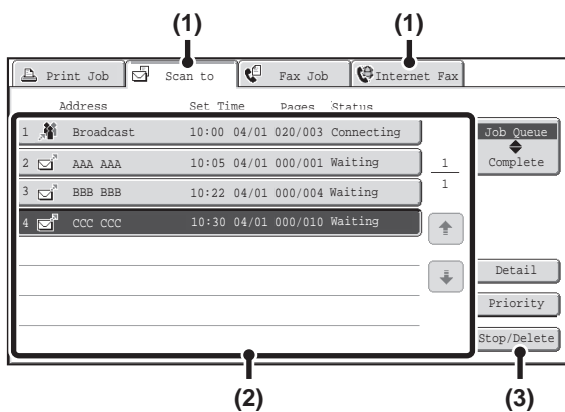

Select the job that you wish to stop.

- (1) Touch the mode tab of the job to be stopped.
- (2) Touch the key of the job to be stopped.
- (3) Touch the [Stop/Delete] key.

3

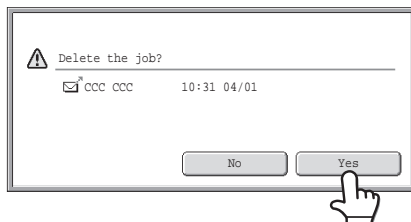

Touch the [Yes] key.



If you do not want to stop the selected job...  
Touch the [No] key.



Printing of a received Internet fax cannot be stopped.



# GIVING PRIORITY TO A SCAN TRANSMISSION JOB

When multiple jobs are waiting to be transmitted, the jobs are normally transmitted in the order they were reserved. If you need to give priority to a job and send it ahead of the other jobs, follow the steps below.

1

JOB STATUS



Press the [JOB STATUS] key.

2

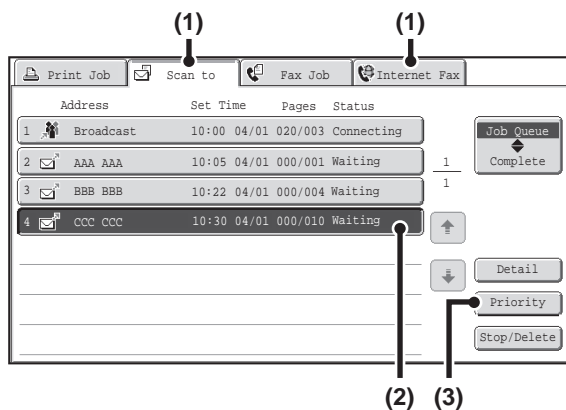

Select the job to which you wish to give priority.

- (1) Touch the mode tab of the job to be given priority.
- (2) Touch the key of the job to be given priority.
- (3) Touch the [Priority] key.

The selected job moves up to the position immediately following the job in progress. The job will be executed when the job in progress is completed.

# CHECKING THE INTERNET FAX ACTIVITY LOG (Image Sending Activity Report)

## IMAGE SENDING ACTIVITY REPORT

You can have the machine print a log of recent image sending activity (date, name of other party, time required, result, etc.). The Image Sending Activity Report contains useful information such as the types of errors that occurred.

The most recent 200 transactions are included in the report.

You can have the machine print the Image Sending Activity Report each time the number of transactions reaches 201, or at a specified time (once a day only).

 The contents of the Image Sending Activity Report are erased when the report is printed, and thus it cannot be reprinted.

 **System Settings (Administrator): Activity Report Print Select Setting**  
This is used to set the conditions for printing activity reports. The factory default setting is not to print. The Image Sending Activity Report can be set to print each time the number of transactions reaches 201, or at a specified time (once a day only).

## INFORMATION APPEARING IN THE RESULT COLUMN

Error types and other information are printed in the result column of transaction and activity reports. When a transaction report or activity report is printed, check the result of the transaction in the result column and take action as needed.

### Examples of messages that are printed in the result column

Message	Explanation
OK	The transaction was completed normally.
OK REPORT	A receive report was requested for a transmission, the transmission was completed normally, and the receive report was received from the destination.
CANCEL	A transmission was stopped while in progress, or a reserved transmission job was canceled.
MEM. FULL	The memory became full during reception.
REJECTED	An Internet fax was sent from a party that is blocked.
NG REPORT	A receive report was requested for a transmission, however, the transmission did not take place correctly and a transmission failed report was received.
NO REPORT	A receive report was requested for a transmission, however, a report was not received within the timeout time.
NG LIMIT	Transmission was not possible because the file size exceeded the machine's file size limit setting.
RECEIVED	An e-mail was received, however, the attached file was not a TIFF-F file or there was no attached file, and thus printing was not possible.
FAIL xx (xxxx)	The transaction failed due to a communication error. First 2 digits of communication error number: Error code from 00 to 99. Last 4 digits of communication error number: Code for use by service technicians.

# INTERNET FAX RECEPTION FUNCTIONS

This section explains the basic procedures for receiving Internet faxes.

## RECEIVING AN INTERNET FAX

The Internet fax function periodically\* connects to the mail server (POP3 server) and checks whether or not Internet faxes have been received. When faxes have been received, the faxes are automatically retrieved and printed.

\* The default setting is once every 5 minutes.



If faxes will be received at night, keep the main power switch in the "on" position.

1

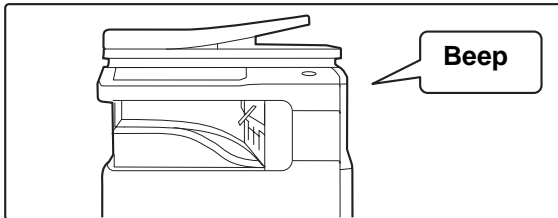

**Internet faxes are received automatically.**

A beep sounds when reception ends.

2

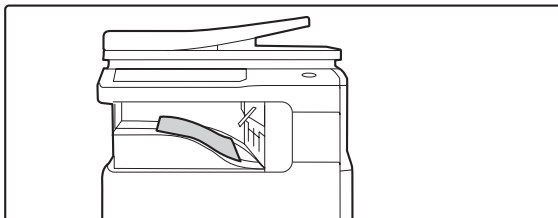

**The Internet faxes are printed automatically.**



If the machine is out of paper or there is no paper that matches the size of the received fax, a message will appear in the touch panel. Follow the instructions in the message to load an appropriate size of paper.



- **System Settings: Fax Data Receive/Forward (page 7-25)**

When printing is not possible because the machine has run out of paper or toner, received Internet faxes can be forwarded to and printed by another previously stored Internet fax machine.

- **System Settings (Administrator): I-Fax Default Settings**

These settings are used to select how received faxes are handled when the [POWER] key (⏻) is "off" (the main power switch is "on"), the volume of the beep that sounds when reception ends, and whether or not received e-mail messages are printed.

- **System Settings (Administrator): I-Fax Receive Settings**

Settings related to Internet fax reception can be configured such as the interval for checking for received faxes, duplex reception, auto reduction printing, and storing allow/reject reception addresses.

- **System Settings (Administrator): Allow/Reject Mail or Domain Name Setting**

This setting is used to allow/refuse reception from stored addresses and domains.

- **System Settings (Administrator): Receiving Date & Time Print**

Use this to select whether or not the date and time of reception is added when a received image is printed.

# MANUALLY RECEIVING INTERNET FAXES

If the interval for checking for received faxes is somewhat long and you wish to check immediately, you can manually initiate reception.

Touch the [I-Fax Manual Reception] key to connect to the mail server and retrieve received faxes.

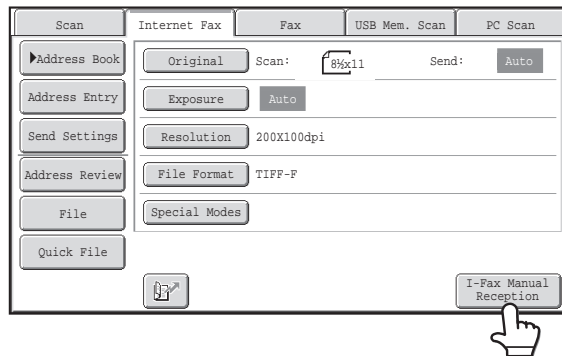



 If POP3 server settings are not configured in the Web pages, the [I-Fax Manual Reception] key is grayed out to prevent selection.

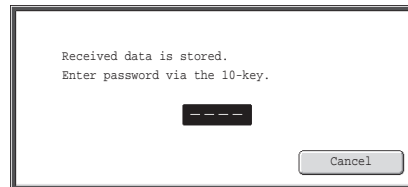

 **System Settings: Fax Data Receive/Forward (page 7-25)**  
This setting is used to hide the [I-Fax Manual Reception] key that appears in the base screen of Internet Fax mode. When the [I-Fax Manual Reception] key is hidden, manual reception is initiated by touching the [Reception Start] key in the screen that appears when "Fax Data Receive/Forward" - "I-Fax Settings" is selected.

# PRINTING A PASSWORD-PROTECTED FAX (Hold Setting For Received Data Print)

"Hold Setting for Received Data Print" in the system settings (administrator) can be enabled to have faxes received to memory without being printed. To print the faxes, a password must be entered. When this function is enabled, a password entry screen appears in the touch panel when received Internet faxes are retrieved.



When the previously programmed 4-digit password is entered with the numeric keys, printing begins. The [Cancel] key can be touched to close the password entry screen; however, the data in memory key (  ) will blink in the touch panel. The password entry screen will reappear when you touch the blinking key (  ) or change modes. When "Received Data Image Check Setting" is enabled in the system settings (administrator), a password can be entered to display the received data list screen. If you wish to check an image before printing it, continue from step 1 on the next page.

-  • The received faxes will be retained in memory regardless of whether they were received automatically or manually.
-  • If "Fax Data Receive/Forward" is enabled in the system settings so that received faxes are forwarded to another machine, faxes retained in memory are also forwarded. At that time, the same password entry screen will appear as for printing. Forwarding will not take place unless the password is entered.

-  **System Settings (Administrator): Hold Setting for Received Data Print**  
Enable this setting to have faxes received to memory without being printed. This setting is also used to program the password that must be entered to print the faxes.

# CHECKING THE IMAGE BEFORE PRINTING

When "Received Data Image Check Setting" is enabled\* in the system settings (administrator), you can check a received image in the touch panel before printing it out. When this function is enabled, follow the steps below to print a received image.

\* The factory default setting is disabled.

1

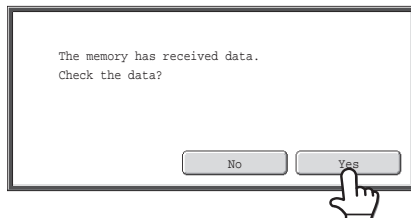

**When an image is received, a confirmation prompt will appear. Touch the [Yes] key.**

If this message appears while you are configuring settings of any type and you touch the [Yes] key, the settings that you are configuring will be cancelled. If this message appears in another mode, you will return to the base screen of image send mode after checking the image.

2

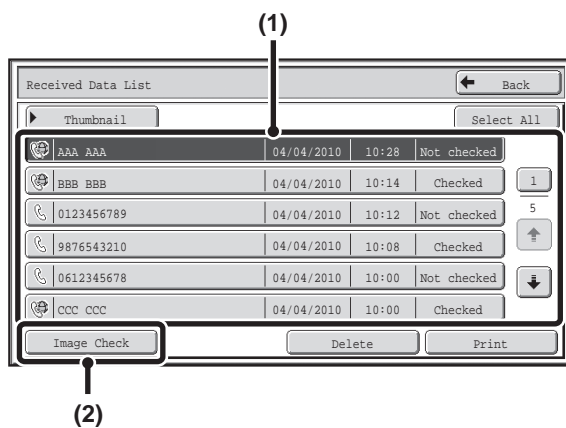

**Select the received image**

**(1) Touch the key of the received image that you want to check.**

Multiple received images can be checked.

**(2) Touch the [Image Check] key.**

- To show thumbnails of the received images, touch the [Thumbnail] key.
- To delete an image that has been selected, touch the [Delete] key. To print an image that has been selected, touch the [Print] key.

3

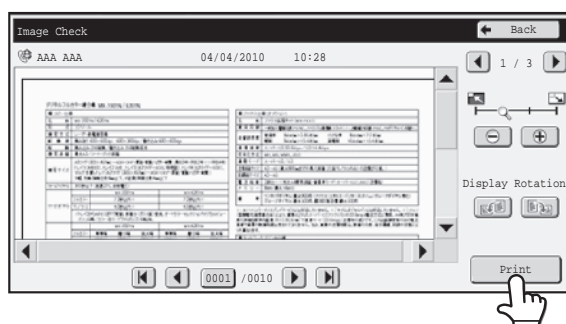

**Check the received image and then touch the [Print] key.**

Printing begins.

For information on the image check screen, see "[IMAGE CHECK SCREEN](#)" (page 5-114).

If the screen of step 1 appears when you are configuring settings in the setting screens of any of the modes, the configured settings will be cancelled if you view the image. After viewing the image, you will return to the base screen of image send mode, regardless of which mode you were in previously.

**System Settings (Administrator): Received Data Image Check Setting**  
Use this to specify whether or not a received Internet fax can be viewed before it is printed.

# IMAGE CHECK SCREEN

This section explains the image check screen.

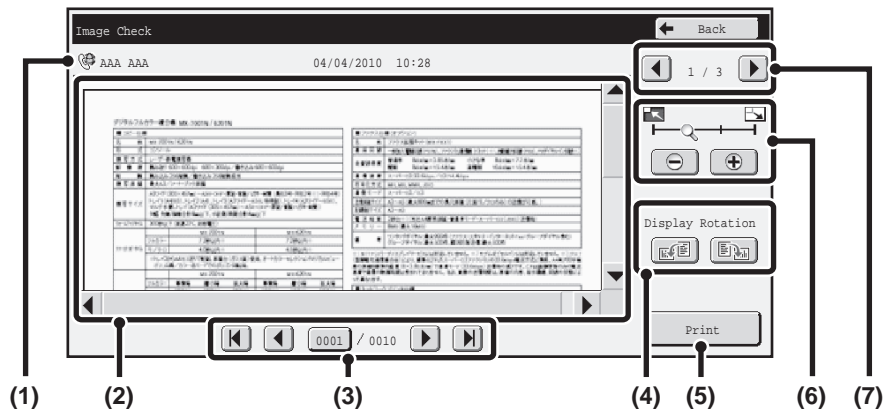

## (1) Information display

This shows information on the displayed image.

## (2) Preview image

An image of the selected received image appears. If the image is cut off, use the scroll bars at the right and bottom of the screen to scroll the image. Touch a bar and slide it to scroll. (You can also touch the keys to scroll.)

## (3) Change page keys

When there are multiple pages, use these keys to change pages.

- keys: Go to the first or the last page.
- keys: Go to the previous page or the next page.
- Page number display: This shows the total number of pages and the current page number. You can touch the current page number key and enter a number with the numeric keys to go to that page number.

## (4) "Display Rotation" key

This key rotates the image right or left by 90 degrees. The rotation applies to all pages in the file, not just the displayed page.

## (5) [Print] key

Touch this key to start printing.

## (6) Display zoom key

Use this key to set the zoom ratio of the displayed image. The setting applies to all pages in the file, not just the displayed page.

## (7) Image select key

When multiple images are selected for preview display, use this key to change the displayed images.





A preview image is an image for display on the touch panel. It will differ from the actual print result.

# FORWARDING RECEIVED INTERNET FAXES TO A NETWORK ADDRESS (Inbound Routing Settings)

Received Internet faxes can be automatically forwarded to an e-mail address, file server address, desktop address, or network folder address. When this function is enabled, you can also have received Internet faxes forwarded without printing them.

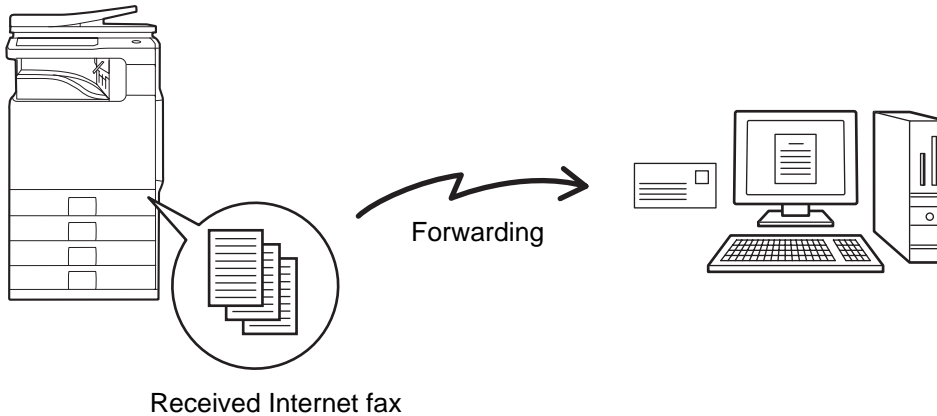
The machine



 When faxes forwarded using this function are printed at the forwarding destination, the date and time of reception cannot be printed on the faxes. ("Receiving Date & Time Print" is disabled.)

## CONFIGURING INBOUND ROUTING SETTINGS

All inbound routing settings are configured in the Web pages. For the procedure for accessing the Web pages, see the Start Guide.

The following explanation assumes that the Web pages have been accessed with administrator rights.

To configure inbound routing settings, follow the steps below.

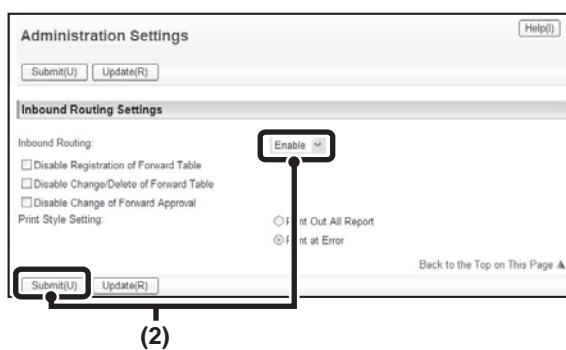

### Enabling the inbound routing function.

- (1) In the Web page menu, click [Application Settings], [Inbound Routing Settings], and then [Administration Settings].
- (2) Select [Enable] in "Inbound Routing" and click the [Submit] button.

 Users without administrator rights can be prohibited from storing, editing, and deleting forwarding tables in this screen, and from specifying which table is used. To do so, select the checkboxes below .

- Disable Registration of Forward Table
  - Disable Change/Delete of Forward Table
  - Disable Change of Forward Approval
- When inbound routing is enabled, you can also specify whether or not you wish the machine to print the forwarded faxes. To have all received faxes printed before being forwarded, select "Print Out All Report" in "Print Style Setting". To have received faxes printed only when an error prevents forwarding, select "Print at Error". After configuring the settings, be sure to click the [Submit] button.



2

## Storing sender addresses.

If you wish to have only faxes from specified addresses forwarded, store the desired sender addresses. Sender addresses stored here can be selected from a list when you store a forwarding table.

- (1) Click **[Sender Number/Address Registration]** in the **[Inbound Routing Settings]** menu in the Web page.
- (2) Enter the sender address in **"Internet Fax Address"** or **"Fax Number"** as appropriate, and click the **[Add to List]** button.

The entered address will be added to the "Address to be Entered" list.

- Specify whether the address will be directly entered (maximum of 1500 characters) or selected from a global address book by clicking the **[Global Address Search]** button.
- To store multiple addresses, repeat this step.

- (3) When you have finished adding addresses, click the **[Submit]** button.



- A maximum of 500 sender numbers/addresses can be stored.
- To delete an entered address, select the address in "Address to be Entered" and click the **[Delete]** button.

Table Registration

Submit(U) Cancel(C)

Table Name: \_\_\_\_\_ (Up 36 characters)

Receive Line Select:  
 Internet Fax  
 Fax

Sender Number/Address Setting:  
 Forward All Received Data  
 Forward Received Data from Below Sender  
 Forward Received Data from Senders except Below

Sender Number/Address: Sender Number/Address to be used in this table.

011112222	011112222
011113333	011113333
022223333	022223333
022224444	022224444
033334444	033334444
033335555	033335555
044445555	044445555
044446666	044446666
ifax@sssss.co.jp	ifax@sssss.co.jp
ifaxaddress@aaaaa.cp.jp	ifaxaddress@aaaaa.cp.jp

Add(Y) Delete(D)

Switch to Single Screen Mode

Forward Destination 1

Forward Condition:  
 Not Forward  
 Always Forward  
 Forward on Selected Day & Time

Day of the Week:  
 Monday  Tuesday  Wednesday  
 Thursday  Friday  Saturday  
 Sunday  
 Select All(S) Clear Checked(Z)

Set Forwarding Time  
 Start Time: 00:00 Hour Minute  
 Completing Time: 00:00 Hour Minute

Format: TIFF (Multi)

Forwarding Destination Settings:  
 Index: All Destina n  
 Display Items: 10

Forward Destination	Name	Type	Address	No.
<input type="checkbox"/>	User A	Internet Fax	tanaka@aaa.bbb.ccc.ddd	2
<input type="checkbox"/>	User B	Mail	suzuki@aaa.bbb.ccc.ddd	3
<input type="checkbox"/>	User C	User	vasasa@bbbb	4
<input type="checkbox"/>	User D	User	10.20.30.40	5

Total Address: 4  
 Display Previous Page(M) 1/1 Display Next Page(N)

Submit(U) Cancel(C)

## Store a forwarding table.

Follow the steps below to store a forwarding table that combines a specified sender and forwarding address.

(1) Click [Inbound Routing Settings] in the Web page menu and click the [Add] button.

(2) Enter a "Table Name".

(3) Select the line used for reception. (MX-B402SC only)

(4) Select the sender whose faxes will be forwarded.

- To forward all received faxes, select [Forward All Received Data].

### MX-B402

- To forward faxes received from a specific sender only, select [Forward Received Data from Below Sender], select the sender from the list, and then click the [Add] button.

### MX-B402SC

- To forward only data received from specific senders, select [Forward Received Data from Below Sender]. To forward all data except data from specific senders, select [Forward Received Data from Senders except Below]. Select the appropriate senders from the list and click the [Add] button.

(5) Select the forwarding conditions. (MX-B402SC only)

- To always forward received data, select [Always Forward].
- To specify a day and time on which received data will be forwarded, select [Forward on Selected Day & Time] and select the checkbox  of the desired day of the week. To specify a time, select the [Set Forwarding Time] checkbox  and specify the time.

(6) Select the file format.

The format can be set separately for each forwarding address (for each of forwarding addresses 1, 2, and 3 in the table).

(7) Select the forwarding address.

Forwarding addresses can be selected from the machine's address book. (Multiple addresses can be selected.) A maximum of 1000 forwarding addresses can be stored (a combined maximum of 100 file server, desktop, and network folder addresses can be stored).

(8) Click [Submit].



- When selecting senders from the "Sender Number/Address Setting" list, you can use the [Shift] key or the [Ctrl] key on your keyboard to select multiple senders.
- A maximum of 50 forwarding tables can be stored.
- Images sent in TIFF format may not display correctly in some recipient environments. In this event, change the file format to PDF.
- For the MX-B402, If you wish to select a group of addresses for the forwarding destination, you can only select a group that contains e-mail addresses only.
- For the MX-B402SC, up to three forwarding day and time settings can be set for one forwarding table, and a forwarding destination can be set for each set time. To configure these settings, use the forwarding list tabs to access each setting.

(2)

**Inbound Routing Settings**

Submit(L) Update(R) Login(P) Help(O)

Inbound Routing Settings: Enable  
Display Items: 10

Table Name	Forward Condition
<input type="checkbox"/> Table 1	Forward Destination 1 <input type="radio"/> Not Forward <input type="radio"/> Always Forward <input type="radio"/> Forward on Selected Day & Time
	Forward Destination 2 <input type="radio"/> Not Forward <input type="radio"/> Always Forward
	Forward Destination 3 <input type="radio"/> Not Forward <input type="radio"/> Always Forward
<input type="checkbox"/> Table 2	Forward Destination 1 <input type="radio"/> Not Forward <input type="radio"/> Always Forward <input type="radio"/> Forward on Selected Day & Time
	Forward Destination 2 <input type="radio"/> Not Forward <input type="radio"/> Always Forward
<input type="checkbox"/> Table 3	Forward Destination 1 <input type="radio"/> Not Forward <input type="radio"/> Always Forward <input type="radio"/> Forward on Selected Day & Time
	Forward Destination 2 <input type="radio"/> Not Forward <input type="radio"/> Always Forward
	Forward Destination 3 <input type="radio"/> Not Forward <input type="radio"/> Always Forward

Total Table 3  
Previous(M) 1/1 Next(N)  
Select All(S) Clear Checked(Z)  
Delete(O) Add(Y)  
Submit(L) Update(R) Back to the Top on This Page A

(3)

## Specifying forwarding tables to be used.

To use the inbound routing function, enable the forwarding tables that you wish to use from among the stored tables.

(1) Click [Inbound Routing Settings] in the Web page menu.

(2) **MX-B402**

Select the "Forward Activated" checkbox of each forwarding table that you wish to use.

**MX-B402SC**

Select [Always Forward] or [Forward on Selected Day & Time] from the forwarding table.

The forwarding permission settings that appear here are linked to the forwarding conditions set in step 3. If you wish to use different forwarding conditions than those set in step 3, set the forwarding permission settings

(3) Click [Submit].



To delete a forwarding table, click the checkbox next to the table name so that it is selected  and click [Delete].

# SCANNING FROM A COMPUTER (PC Scan Mode)

## BASIC SCANNING PROCEDURE

You can install the scanner driver on your computer from the CD-ROM that accompanies the machine, and use a TWAIN\* compliant application to scan an image using your computer.

Scanning from your computer is most useful for scanning a single original such as a photo, particularly when you want to adjust scan settings as you scan. By contrast, scanning at the machine is most useful for continuous scanning of multiple originals.

\* An interface standard used for scanners and other image input devices. When the scanner driver is installed on your computer, you can use any TWAIN-compliant application to scan an image.

-  Scanning in PC scan mode is only possible when the scanner driver has been installed from the "Software CD-ROM" using the integrated installer. For the procedures for installing the scanner driver and configuring settings, see the Start Guide.
- This function cannot be used when it has been disabled using "Disable Scan Function" in the system settings (administrator).
- The procedures for selecting the scanner driver and starting scanning vary depending on the TWAIN-compliant application. For more information, see the manual for the application or Help.
- When a large image is scanned at high resolution, the amount of data will be very large and scanning will take a long time. Be sure to select appropriate scan settings for the original (text, photo, etc.).

As an example, the procedure for scanning from the "Sharpdesk" application that accompanies the machine is explained below.

### [At the machine]

#### 1 Place the original.

Place the original face up in the document feeder tray, or face down on the document glass.

 [PLACING THE ORIGINAL](#) (page 1-37)

When the original is a different size than the size setting, set the original size.

 [SPECIFYING THE ORIGINAL SCAN SIZE AND SEND SIZE](#) (page 5-56)

#### 2

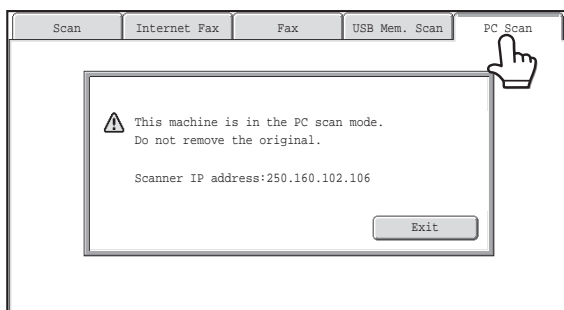

#### Touch the [PC Scan] tab to switch to PC Scan mode.

If the [PC Scan] tab does not appear, touch the  tab to move the screen.

-  When PC scan mode is selected, only the [Exit] key displayed in the touch panel can be used on the machine; no other keys can be used.

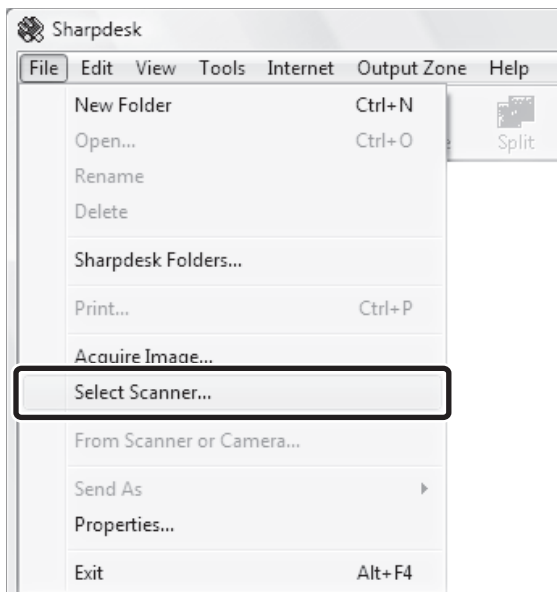
**[At your computer]****3**

**Start the TWAIN-compliant application on your computer and select [Select Scanner] from the [File] menu.**

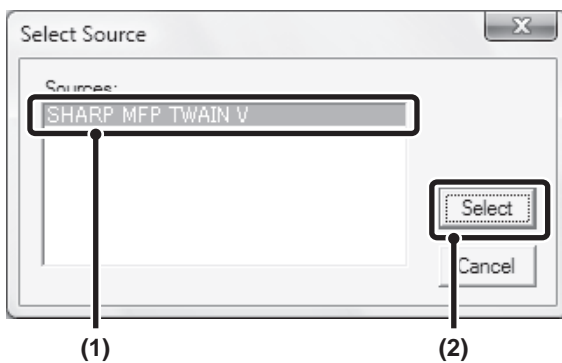
**4**

**Select the scanner driver of the machine.**

- (1) Select [SHARP MFP TWAIN V].
- (2) Click the [Select] button.

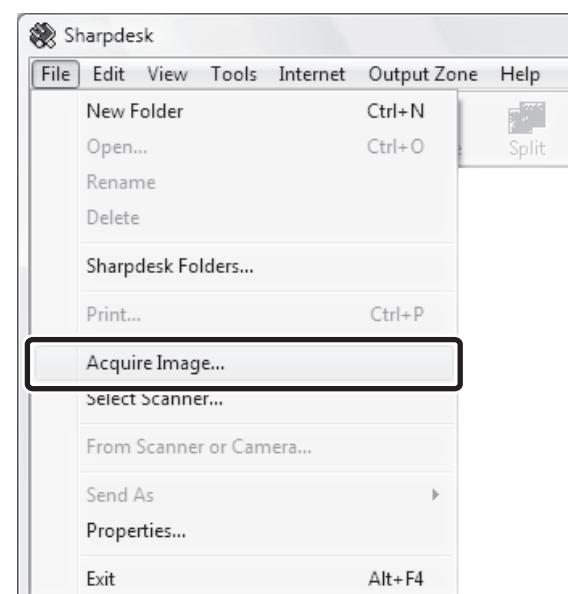
**5**

**Select [Acquire Image] from the [File] menu.**

The scanner driver opens.

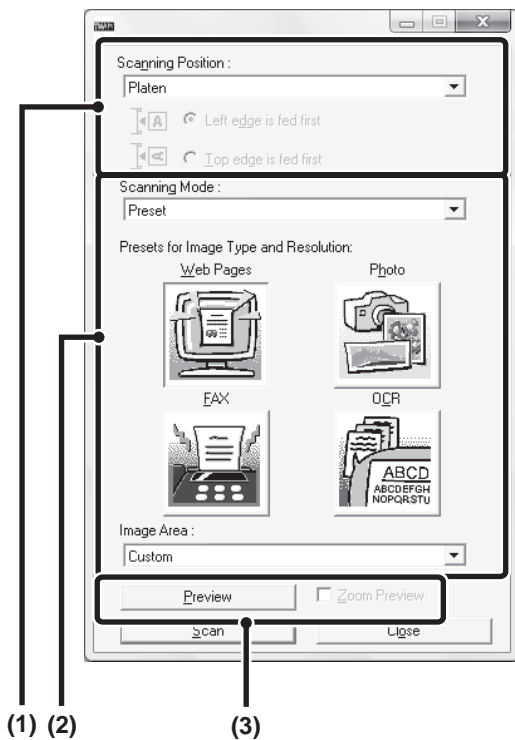

6

## Preview the image.

- (1) Select the location where the original is placed.

### "Scanning Position" menu:

- If the original is a one-sided original and is placed in the document feeder tray, select [SPF(Simplex)].
- If the original is a 2-sided original and is placed in the document feeder tray, select [SPF(Duplex - Book)] or [SPF(Duplex - Tablet)] depending on whether the original is a book-style or tablet-style original. In addition, select [Left edge is fed first] or [Top edge is fed first] depending on the orientation of the original.

### MX-B402SC only

### Select the location where the original exits.

If you use the heavy paper or plastic card, select [Heavy exit].

- (2) Select scan settings.

### "Scanning Mode" menu:

Switch between the "Preset" screen and the "Custom Settings" screen. In the "Preset" screen, select "Web Pages", "Photo", "FAX" or "OCR" depending on the original type and your scanning purpose.

If you wish to change the initial settings of any of the four buttons or select the resolution or other advanced settings, change to the "Custom Settings" screen.

### "Image Area" menu:

Select the scan area. You can also set the scanning area in the preview window with your mouse.

- (3) Click the [Preview] button.

The preview image will appear in the scanner driver.

If you are not satisfied with the preview image, repeat (2) and (3).

If the [Zoom Preview] checkbox is selected before the [Preview] button is clicked, the selected area will be enlarged in the preview window. If the checkmark is removed, the preview image will return to normal. Note that if SPF is selected in the "Scanning Position" menu, the [Zoom Preview] function cannot be used.



- For further information on the scan settings, click the  button in the preview image screen of step 7 to open scanner driver Help.
- If the [Preview] button is clicked when scanning from the document feeder tray, only one original page will be scanned for the preview image. If you wish to include that original in the scan, return it to the document feeder tray.

7

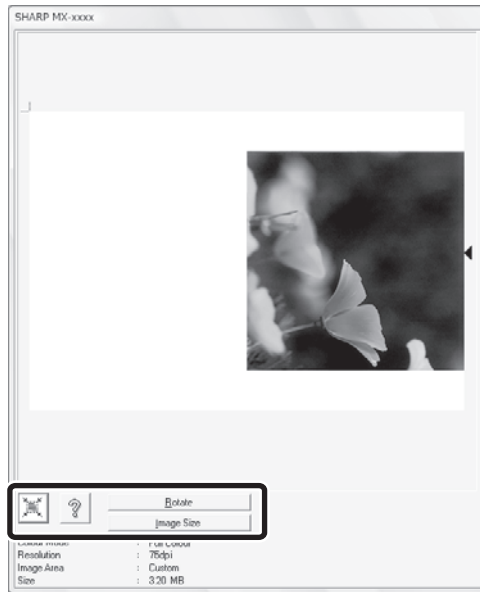

## Select scanning settings while viewing the image.

### [Rotate] button:

Each time this button is clicked, the preview image rotates 90 degrees. This lets you change the orientation of the image without picking up and placing the original again. The image file will be created using the orientation that appears in the preview window.

### [Image Size] button:

Click this button to specify the scan area by entering numerical values. Pixels, mm, or inches can be selected for the units of the numerical values. If a scanning area has already been specified, the entered numbers will change the area relative to the top left corner of the specified area.

### button:

When a preview image is displayed and a scanning area is not specified, you can click the  button to automatically set the scanning area to the entire preview image.



- For further information on the scan settings, click the  button to open scanner driver Help.
- If the originals are placed in the document feeder tray, only the top page will be previewed. The top page will be delivered to the original exit tray. Be sure to return the previewed page to the document feeder tray before previewing again or scanning.

8

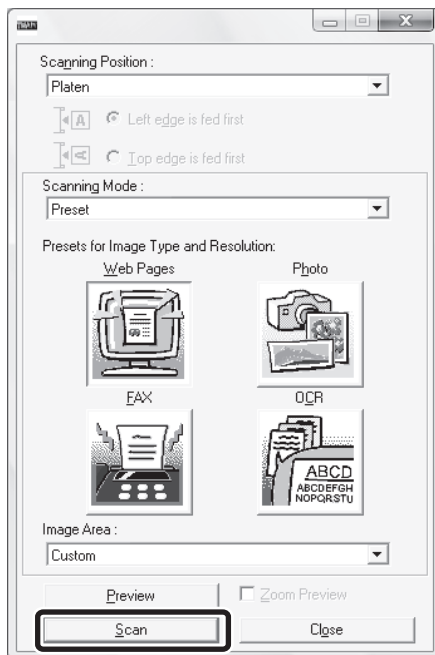

## Click the [Scan] button.

Scanning begins. The image appears in your application. Assign a file name to the scanned image and save it as appropriate in the software application you are using.

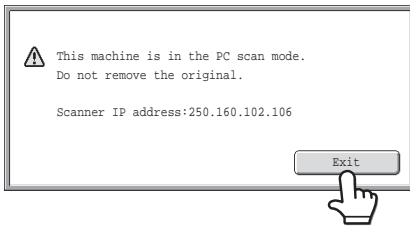
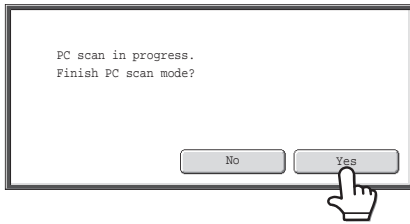
**[At the machine]****9****Touch the [Exit] key in the touch panel.****10****Touch the [Yes] key.**



# METADATA DELIVERY

This section explains metadata delivery, which can be used when the application integration module kit is installed.

## METADATA DELIVERY (Data Entry)

When the application integration module kit is installed and an image file is generated for a scan send transmission, metadata (data indicating the attributes of the image file and how it is to be processed) can be generated based on pre-stored information and transmitted as a separate file. The metadata file is created in XML format. By linking the metadata with applications such as document management software, a workflow application, or an encryption server, a sophisticated document solution environment can be built.

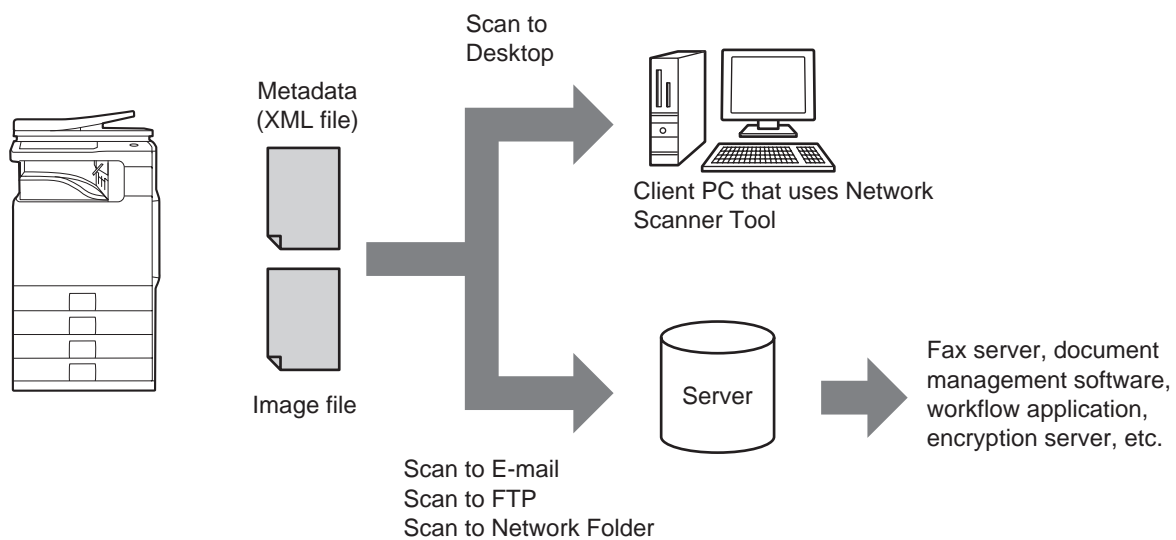

Using the application integration module kit, information on a generated image file can be entered at the touch panel and transmitted along with the image as an XML file.

# PREPARATIONS FOR METADATA TRANSMISSION

## SETTINGS REQUIRED IN THE WEB PAGES

All settings related to metadata are configured in the Web pages. (Administrator rights are required.) To configure metadata settings, click [Application Settings] and then [Metadata Settings] in the Web page menu. When configuring settings, be sure to enable metadata transmission.

### Storing Metadata Sets

Store the items (the metadata set) that are written to the XML file that is generated during scanning. Up to 10 metadata items can be configured in a metadata set. A stored metadata set can be selected at the time of transmission.



Addresses specified in "Address Type Allowing Metadata Entry" when a metadata set is stored can be selected as transmission destinations at the time of transmission using one-touch keys, manual entry, and/or a global address book search. (Addresses for which metadata entry is not allowed cannot be specified as transmission destinations.)

## METADATA TRANSMISSION FOR SCAN TO DESKTOP

When Network Scanner Tool is used in its factory default configuration, a file will be generated with a new file name on the computer. When Network Scanner Tool is used as a means of sending a metadata file to a third party software application, this setting must be disabled to allow cross referencing between the image file and XML file by means of the file name generated by the computer. (When setting the file name in [Send Settings], to ensure that a previously existing file on a computer is not overwritten by a transmitted file of the same name, be sure to configure the file name so that name duplication cannot occur; for example, by including a unique extension (the date, etc.) in the generated file name. If the file name setting is left blank, the machine will automatically generate a file name that is unique.)



- It is recommended that you use Network Scanner Tool to receive metadata. For more information, see the Network Scanner Tool User's Guide (PDF format) on the "Sharpdesk/Network Scanner Utilities" CD-ROM.
- For information on the license agreement and how to use the CD-ROM that accompanies the application integration module, see the separate "Sharpdesk licence kit" manual.
- **Using third party software applications**  
Various types of third party software applications exist. Some applications can start automatically from Network Scanner Tool and some cannot. When the auto-run function of an application is enabled, Network Scanner Tool will start the application with the ".exe" command using the file name as a parameter. Normally an application is started twice, once for the image file and once for the XML file. For example, when Network Scanner Tool is set to start the application "APP.EXE", the following commands are applied when the two files "IMG.TIF" and "IMG.XML" are received.  
APP.EXE IMG.TIF  
APP.EXE IMG.XML

# TRANSMITTING METADATA

Follow the steps below to select a metadata set, enter each item, and perform metadata transmission.

1

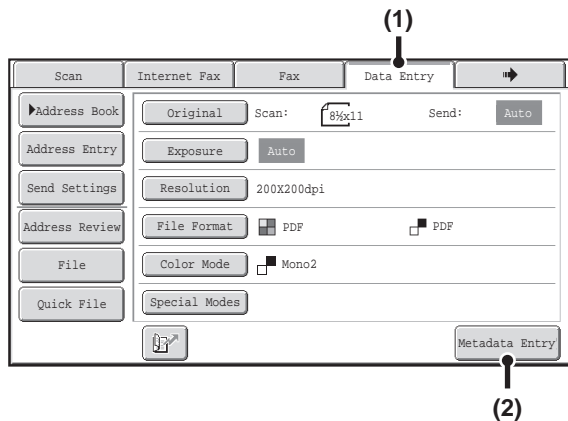

Switch to data entry mode and display the metadata set screen.

- (1) Touch the [Data Entry] tab.
- (2) Touch the [Metadata Entry] key.



- If no metadata sets have been stored, the [Data Entry] tab cannot be selected. Store a metadata set in the Web pages and then perform the transmission procedure.
- If a specific metadata set has been specified as the default set, go to step 3.

2

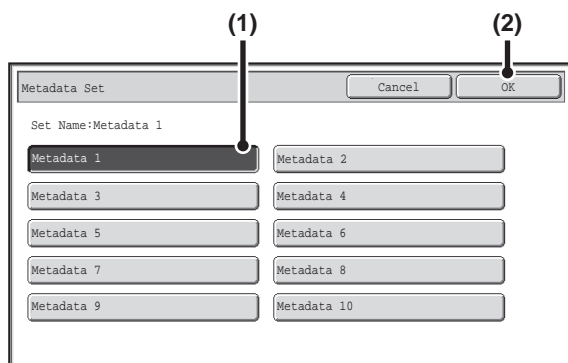

Select a metadata set.

- (1) Touch the key of the metadata set that you wish to use.
- (2) Touch the [OK] key.

3



The keys of the items stored in the metadata set will appear. Touch the key of the item that you want to enter.



- If you accidentally selected the wrong metadata set or wish to use a different metadata set when a default metadata set has been set, touch the [Metadata Set] key. Touch the [OK] key in the message screen that appears. You will return to the screen of step 1. Metadata items entered to that point will be canceled.

4

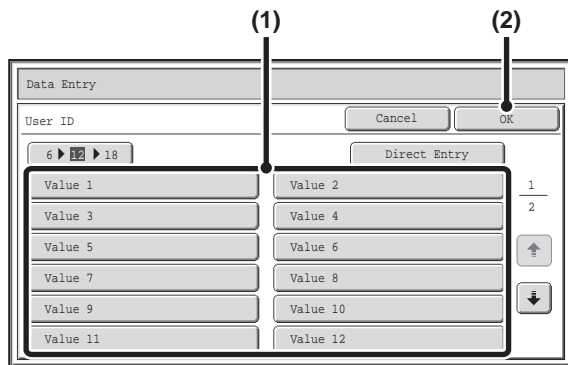

## Enter the selected metadata item.

### (1) Touch the key of the value that you wish to enter.

- When the entry values of the metadata item are in the form of selections, the selections are shown as keys. When a value is editable, you can touch the [Direct Entry] key to manually enter the value.
- If the metadata item requires the entry of text, a text entry screen will appear. Enter the required information.

### (2) Touch the [OK] key.



- To change the number of keys displayed in the screen, touch the number of displayed items selector key. Select 6, 12, or 18 keys.
- For the procedure for entering text, see "ENTERING TEXT" (page 1-76) in "1. BEFORE USING THE MACHINE".

5

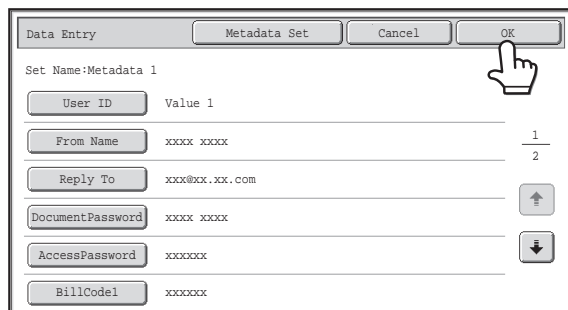

## When you have finished entering all items, touch the [OK] key.

6

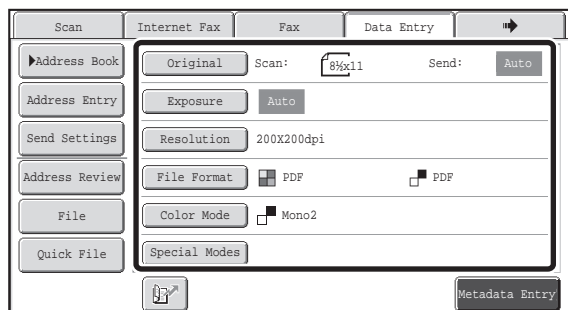

## Select image settings and any other settings, and perform the scan send procedure.

- The procedures for selecting settings and performing transmission are the same as in the other modes.
- To make changes to entered values, touch the [Metadata Entry] key once again. The entry screen of the selected metadata set will appear.



- Transmission cannot be performed if the [Data Entry] tab is displayed and no metadata settings have been configured. To perform transmission without sending metadata, switch to a different mode by touching the tab of that mode and then perform transmission.
- Before configuring metadata settings, you can specify addresses in all modes to be used. After metadata settings have been configured, only addresses in modes that are allowed in the selected metadata set can be specified.
- When metadata settings have been configured or an address is specified in the [Data Entry] tab, it will not be possible to switch to another mode.
- Metadata delivery is possible using the document filing function. The [Data Entry] tab appears in the transmission settings screen of document filing mode to allow metadata delivery. In addition, metadata delivery using document filing can be performed in [Document Operations] in the Web pages.

# METADATA FIELDS

The following three types of metadata are included in the XML file that is transmitted.

- Data automatically generated by the machine: This data is always included in the XML file and is automatically stored on your computer.
- Previously defined fields: These fields are automatically recognized by the machine and assigned to appropriate XML tags. These fields are selectable, and can only be included in the XML file if enabled in the Web pages.
- User defined fields: Custom fields can be added to the XML file. These fields are selectable and can be defined in the Web pages.

If a defined metadata field is one of the following fields, a message will appear informing you that the field cannot be entered. Enter appropriate information in the related items of the send settings.

Name entered in metadata field	Description	Where entered
fromName	Name of the user who sent the job. If the name is not entered as metadata, the sender name determined by the usual rules for determining the sender name will be applied as metadata.	[Reply-To] (Sender name of selected sender)
replyTo	E-mail address to which the transmission result will be sent.	[Reply-To] (E-mail address of selected sender)
documentSubject	Job name appearing in the e-mail "Subject" line, or job name on the fax cover sheet. When the user enters a [Subject] in the send settings screen in the touch panel, the entered value is applied as metadata.	[Subject] (Blank until a value is set in the send settings screen.)
fileName	Enter the file name of the image to be sent.	[File Name] (Only when the [Allow Custom Filenames] checkbox is selected <input checked="" type="checkbox"/> in the metadata settings screen in the Web pages.) (Blank until a value is set in the send settings screen.)

# NETWORK SCANNER / INTERNET FAX\*1

## SPECIFICATIONS

<b>Model</b>	MX-B402	MX-B402SC
<b>Scanning resolution (dpi)</b>	100 x 100, 200 x 200, 300 x 300, 400 x 400, 600 x 600 Internet Fax: 200 x 100, 200 x 200, 200 x 400, 400 x 400, 600 x 600 (200 x 100, 200 x 200 when file type is TIFF-S) Halftone can be selected for resolutions other than 200 x 100 dpi.	
<b>Scanning speed</b>	Color (200 x 200 dpi) One-sided:35 pages/min. (8-1/2" x 11"), 33 pages/min. (A4) Two-sided:12 pages/min. (8-1/2" x 11"/A4) Black and white (200 x 200 dpi) One-sided:35 pages/min. (8-1/2" x 11"), 33 pages/min. (A4) Two-sided:12 pages/min. (8-1/2" x 11"/A4)	Color (200 x 200 dpi) One-sided:50 pages/min. (8-1/2" x 11"/A4) Two-sided:25 pages/min. (8-1/2" x 11"/A4) Black and white (200 x 200 dpi) One-sided:50 pages/min. (8-1/2" x 11"/A4) Two-sided:25 pages/min. (8-1/2" x 11"/A4)
<b>Interface port</b>	LAN connectivity: 10Base-T / 100Base-TX / 1000Base-T	
<b>Supported protocols</b>	TCP/IP (IPv4)	
<b>File formats</b>	Color: (including grayscale)	File types:TIFF, JPEG, PDF, Encrypted PDF, XPS Compression ratio:High / Medium / Low
	Black and white:	File types:TIFF, PDF, Encrypted PDF, XPS Compression modes:None / Medium (G3) / High (G4)
	Internet Fax: (black and white only)	File types:TIFF-FX (TIFF-F, TIFF-S) Compression modes:Medium (G3) / High (G4)
<b>Remarks</b>	Number of one-touch keys for storing destinations*2:	Maximum number of keys: 999
	Number of destinations that can be stored in a group (1 key)*2:	Maximum number of destinations in one group (1 key): 500
	Scan destinations:	Scan to E-mail / Scan to FTP / Scan to Desktop / Scan to Network Folder

\*1 Internet fax expansion kit is required.

\*2 Total number of all destinations (Scan to E-mail, Scan to FTP, Scan to Desktop, Scan to Network folder, Internet Fax, Fax, and Group)

# PULL SCAN FUNCTION (TWAIN) SPECIFICATIONS

<b>Supported protocol</b>	TCP/IP (IPv4)	
<b>Supported client PC operating systems</b>	Windows 2000 / XP / Server 2003 / Vista / Server 2008 / 7	
<b>Color modes</b>	Full Color, Grayscale, Mono Diffusion, Mono 2 gradation	
<b>Resolution settings</b>	75 dpi, 100 dpi, 150 dpi, 200 dpi, 300 dpi, 400 dpi, 600 dpi (The resolution can be specified by entering a numerical value from 50 to 9600 dpi. However, when a high resolution is specified, it is necessary to reduce the scanning area.)	
<b>Scanning area</b>	Document glass	Maximum: 8-1/2" x 11" (A4)
	Automatic document feeder	Maximum: 8-1/2" x 14" (A4)

# CHAPTER 6

# DOCUMENT FILING

This chapter provides detailed explanations of the procedures for using the document filing function. The document filing function allows you to save the document data of a copy or fax job, or the data of a print job, as a file on the machine's hard drive. The file can be called up as needed.

This chapter assumes that you are already familiar with copy mode, scanner mode, and the other modes of the machine.

For information on procedures of copy, scanner and other modes that remain the same when those modes are used in conjunction with the document filing function, see the chapters for those modes.

## DOCUMENT FILING

<b>OVERVIEW</b> .....	<b>6-2</b>
• TYPES OF DOCUMENT FILING .....	6-2
• USES OF DOCUMENT FILING .....	6-3
• BEFORE USING DOCUMENT FILING .....	6-4
• IMPORTANT POINTS WHEN USING DOCUMENT FILING .....	6-7
• USING DOCUMENT FILING IN EACH MODE .....	6-8
<b>BASE SCREEN OF DOCUMENT FILING MODE</b> .....	<b>6-10</b>

## SAVING FILES WITH DOCUMENT FILING

<b>SAVING A FILE WITH "Quick File"</b> .....	<b>6-11</b>
<b>SAVING A FILE WITH "File"</b> .....	<b>6-13</b>
• FILE INFORMATION .....	6-15
<b>SAVING A DOCUMENT FILE ONLY (Scan to HDD)</b> .....	<b>6-18</b>
• "Scan to HDD" SCREEN .....	6-18
• PERFORMING "Scan to HDD" .....	6-23

## USING STORED FILES

<b>SEQUENCE FOR USING A STORED FILE</b> .....	<b>6-25</b>
<b>FOLDER AND FILE SELECTION SCREENS</b> .....	<b>6-27</b>
• FOLDER SELECTION SCREEN .....	6-27
• FILE SELECTION SCREEN .....	6-28
<b>SELECTING A FILE</b> .....	<b>6-30</b>
• JOB SETTINGS SCREEN .....	6-31
<b>PRINTING A STORED FILE</b> .....	<b>6-32</b>
• PRINT SETTINGS SCREEN .....	6-33
• MULTI-FILE PRINTING .....	6-34
<b>SENDING A STORED FILE</b> .....	<b>6-38</b>
• SEND SETTINGS SCREEN .....	6-39
<b>PROPERTIES OF STORED FILES</b> .....	<b>6-40</b>
• FILE PROPERTIES .....	6-40
• CHANGING THE PROPERTY .....	6-40
<b>MOVING A STORED FILE</b> .....	<b>6-42</b>
<b>DELETING A STORED FILE</b> .....	<b>6-44</b>
<b>CHECKING AN IMAGE OF A STORED FILE</b> .....	<b>6-45</b>
• IMAGE CHECK SCREEN .....	6-46
<b>RETRIEVING AND USING A FILE FROM THE JOB STATUS SCREEN</b> .....	<b>6-47</b>
<b>SEARCHING FOR A STORED FILE</b> .....	<b>6-48</b>



# DOCUMENT FILING

This section provides information that you should know before using the document filing function, including an overview of document filing, the features and functions of document filing, and points to keep in mind when using document filing.

## OVERVIEW

The document filing function allows you to save the document image of a copy or image send job, or the data of a print job, as a file on the machine's hard drive.

The stored file can be retrieved and printed or transmitted as needed.

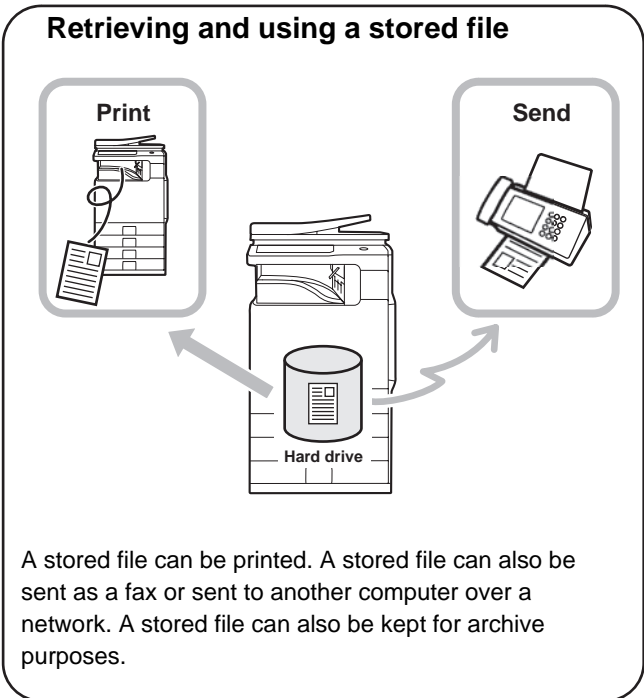
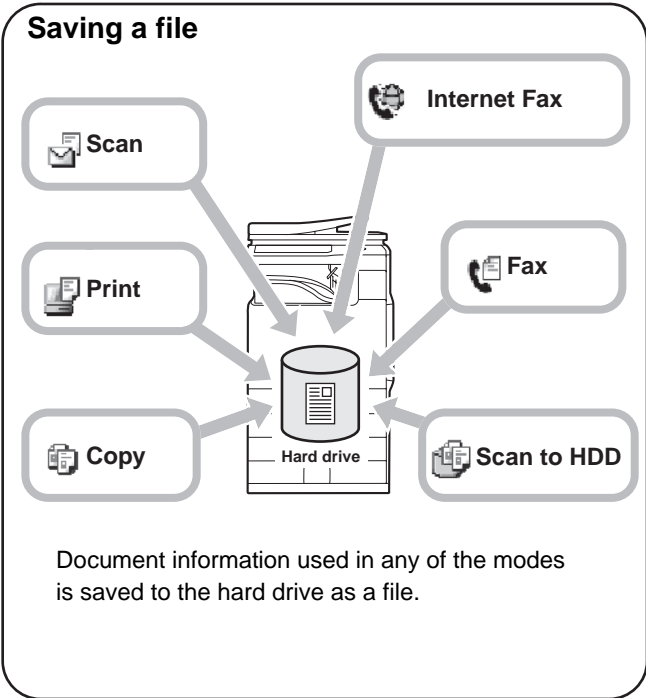

## TYPES OF DOCUMENT FILING

There are three ways to save a file using document filing: "Quick File", "File", and "Scan to HDD".

<b>Quick File</b>	As a copy, scan send, or other job is performed, this function saves the document data to the hard drive. Use this function when you want to quickly and easily store document data without specifying a file name or other information. The stored file can also be used by other people. Do not use this method to save files that you do not want others to use, such as files containing sensitive or confidential information.
<b>File</b>	As a copy, scan send, or other job is performed, this function saves the document data to the hard drive. Unlike Quick File, various types of information can be appended to the file when the file is saved to enable efficient file management. A password can also be established to prevent the file from being retrieved by others.
<b>Scan to HDD</b>	This function scans a document and stores it as a file. Like File, various types of information can be appended to the file when it is stored.

# USES OF DOCUMENT FILING

## Quickly using a file

Example: You prepared handouts consisting of numerous pages for a meeting, however, another handout is needed for a newly added participant.

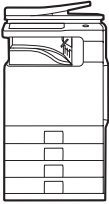
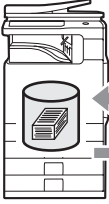
The handout was not saved using document filing	The handout was saved using document filing
 <p>Ratio and special mode settings must be reselected.</p> <p>The numerous original pages must all be rescanned.</p> <p style="text-align: center;">↓</p> <p>Not likely to be completed in time for the meeting...</p>	 <p>The stored file is simply retrieved and printed.</p> <p style="text-align: center;">↓</p> <p>Printing is accomplished quickly and the handout is ready in time for the meeting!</p>
<p>Copy settings must be reselected and the original must be rescanned.</p> <p>As indicated above, to obtain another set of output, the settings must be selected all over again. If you don't remember the settings, much effort may be expended to get the same output result as the previous time.</p>	<p>By retrieving a job stored using document filing, there is no need to reselect copy settings or rescan the original. The job can be retrieved and printed using the same settings quickly and easily.</p>

As shown in the example, storing a job with the document filing function frees you of the need to rescan the original and select settings, saving considerable time.

## Convenient for managing frequently used documents

Example: Managing a large number of business forms

### Not using document filing

It takes time to find the form you need.

### Using document filing

The required form can be easily retrieved from the document filing list, and document management is much more efficient.

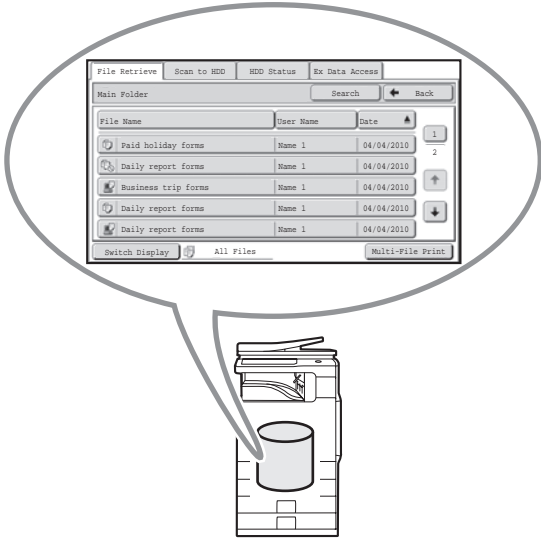

Application forms, report forms, and other business forms can be stored on the hard drive for easy retrieval, letting you print the number of copies you need when you need them.

# BEFORE USING DOCUMENT FILING

This section provides information that you should know before using the document filing function.

## Folders

Three types of folders are used to store files by document filing.

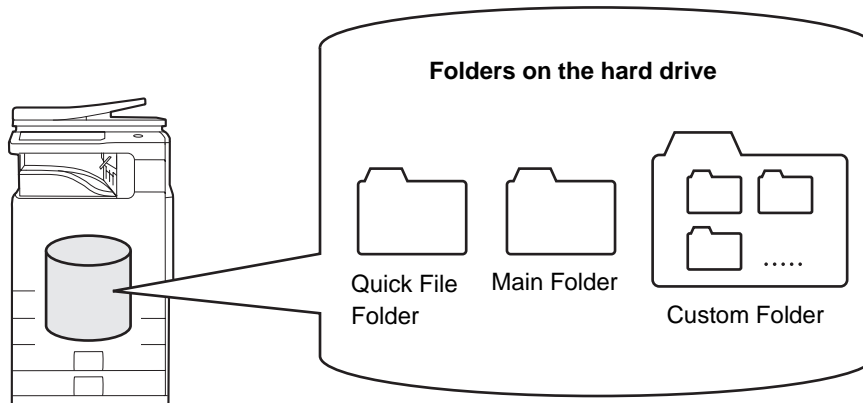

### Quick File Folder

Documents scanned using the [Quick File] key are stored in this folder. A user name and file name are automatically assigned to each job.

### Main Folder

Documents scanned using the [File] key are stored in this folder.

When you store a job in the Main folder, you can specify a previously stored user name and assign a file name.

A password can also be set when storing a file ([Confidential] save).

### Custom Folder

Folders with custom names can be created inside this folder.

When a document is scanned using the [File] key and a folder is selected, the document is stored in the specified folder.

Like the Main folder, a custom folder allows you to specify a previously stored user name and assign a file name when storing a job.

Passwords can be established for custom folders and for files saved in custom folders.



A maximum of 1000 custom folders can be created on the hard drive.

## Items convenient to store

When storing a job using "File" or "Scan to HDD", it is convenient to store the items below. These settings are not needed when storing a job using "Quick File".

<b>User Name</b>	This is necessary if you will be assigning a user name to stored files. User names are stored in "User List" in the system settings (administrator). A user name is also used as a search condition when searching for a file.
<b>Custom Folder</b>	The Main folder is initially available as a location for storing files by "File" and "Scan to HDD". When custom folders have been created using "Document Filing Control" in the system settings, a custom folder can be specified as a location for storing files. A password can also be established for a custom folder to restrict access to the folder.
<b>My Folder</b>	"My Folder" is specified using "User List" in the system settings (administrator). A previously created custom folder can be selected as "My Folder", or a new folder created as "My Folder". When "My Folder" has been configured and user authentication is used, "My Folder" will always be selected as the destination of "File" and "Scan to HDD".



- **System Settings: Document Filing Control (page 7-29)**



This is used to create custom folders for document filing. A password can also be established for a custom folder.

- **System Settings (Administrator): User List**



This is used to store a user name and specify a folder as "My Folder".

# Approximate number of pages and files that can be stored by document filing

Combined total number of pages and total number of files that can be stored in custom folders and in the Main folder

Examples of original types	Number of pages*	Number of files
<b>Full color original</b> (Text and photo example)  Size: 8-1/2" x 11" (A4)	Max. 2500	Max. 3000
<b>Black &amp; white original</b> (Text)  Size: 8-1/2" x 11" (A4)	Max. 5500	

## Number of pages and number of files that can be stored in the Quick File folder

Examples of original types	Number of pages*	Number of files
<b>Full color original</b> (Text and photo example)  Size: 8-1/2" x 11" (A4)	Max. 800	Max. 1000
<b>Black &amp; white original</b> (Text)  Size: 8-1/2" x 11" (A4)	Max. 1700	

\* The indicated numbers are guidelines for the number of pages that can be stored when all pages are full color, and when all pages are black & white.

Copying in sort mode uses the same memory area as the Quick File folder. For this reason, when too much data has been stored in the Quick File folder, it may not be possible to perform a large copy job using sort mode. Delete unneeded files.

The original types above are examples to make the explanation easier to understand. The actual number of pages and number of files that can be stored will vary depending on the contents of the original images and the settings when the files are stored.

## Automatic deletion of files

You can have document filing data in specified folders automatically deleted at regular intervals by specifying the folders and the time. Periodic deletion of files stored in the machine helps to prevent the leaking of sensitive information and frees space on the hard drive.

Every day, every week, or every month can be selected for the deletion cycle, and a time can be set for each selection. For example, you can set file deletion to take place every week on Friday at 6:00 PM.

Automatic file deletion settings are configured in "Automatic Deletion of File Settings" in the system settings (administrator).

To check the settings, print the following list in the system settings.

To check information on the deletion cycle: Print the "Administrator Settings List" in the system settings (administrator).

To check information on the folders selected for file deletion: Print the "Document Filing Folder List" in the system settings.



When "Automatic Deletion of File Settings" is enabled in the system settings (administrator), all files in the specified folders will be deleted when the set time arrives. Take care not to store files that you wish to keep in folders specified for file deletion.



- **System Settings: [Document Filing Control](#) (page 7-29)**

This shows a list of the folder names for document filing.

- **System Settings (Administrator): Automatic Deletion of File Settings**

Configure settings for automatic deletion at regular intervals of files stored using the document filing function.

- **System Settings (Administrator): Administrator Settings List**

Use this to print a list of the administrator settings, including document filing settings.

## Files

When a file is saved using "File", the following information can be appended.

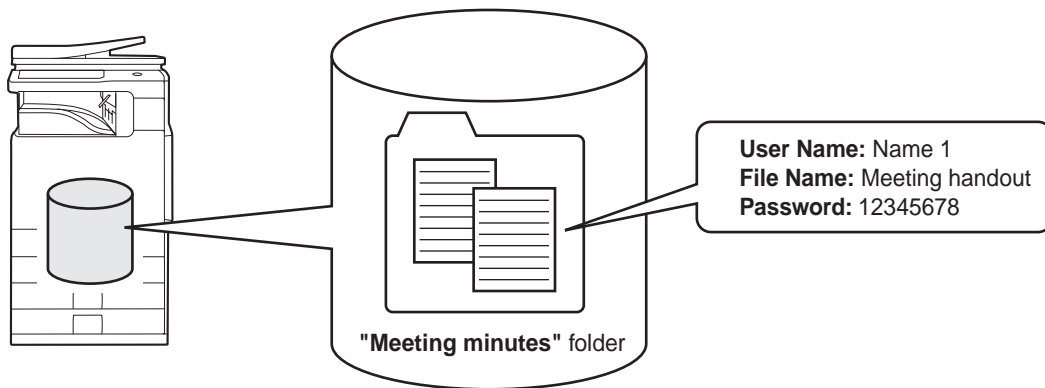

Saving a file with this information allows you to distinguish it from other files.

**User name:** Use this to specify the owner of the file. The user name must first be stored in "User List" in the system settings.

**File Name:** A file name can be entered.

**Folder:** Select which folder the file will be saved in.

**Confidential:** A password (5 to 8 digits) can be established to prevent others from using the file.



The above information cannot be specified when a file is saved with Quick File.



**System Settings (Administrator): User List**

This is used to store user names.

## IMPORTANT POINTS WHEN USING DOCUMENT FILING

Note the following when using document filing:

- Files saved using "Quick File" are assigned the "Sharing" property. "Sharing" files can be retrieved and printed or transmitted by anyone, and thus Quick File should not be used to save sensitive or confidential documents that you do not wish others to use.
- When saving a file with "File", use the "Confidential" property. A password can be set for a "Confidential" file to prevent the file from being used by other people. Take care to keep the password of a stored "Confidential" file secret.
- The property of a stored "Confidential" file can be changed to "Sharing" by "Property Change" when the file is used. Do not store sensitive documents or documents that you do not want to be used by others.
- Except in cases provided for by law, SHARP Corporation bears no responsibility for any damages that result from the leaking of sensitive information due to manipulation by a third party of any data saved using the Quick File function or File function, or incorrect operation of the Quick File function or File function by the operator that saves the data.

# USING DOCUMENT FILING IN EACH MODE

In copy or image send mode, the original can be saved as a file on the hard drive at the same time it is copied or transmitted. In addition, Scan to HDD can be used to save the scanned data of an original to the hard drive without copying or transmitting the data.

## Copy mode

The original is saved as an image file at the same time it is copied.

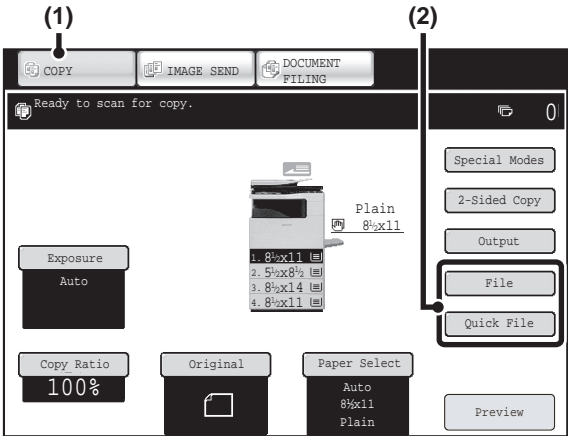

- (1) Touch the [COPY] key.
- (2) Touch the [File] key or the [Quick File] key.

## Image Send mode

**Example: Base screen of scan mode**

The original is saved as an image file at the same time it is scanned and transmitted.

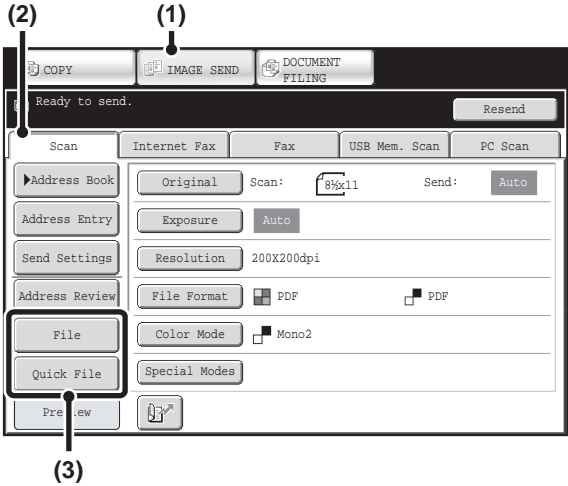

- (1) Touch the [IMAGE SEND] key.
- (2) Touch the [Scan] tab.
- (3) Touch the [File] key or the [Quick File] key.

## Scan to HDD mode

The scanned original is saved as an image file. Neither printing nor transmission are performed when Scan to HDD is used.

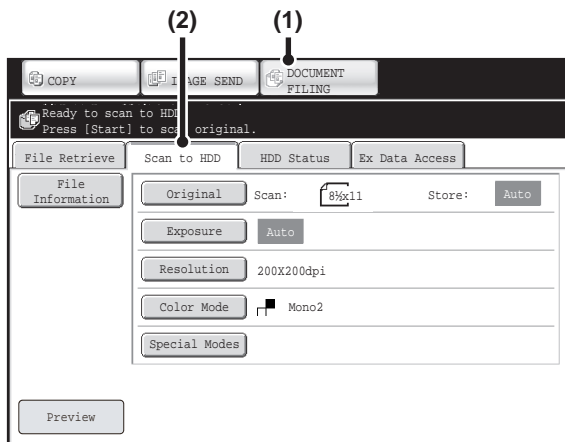

- (1) Touch the [DOCUMENT FILING] key.
- (2) Touch the [Scan to HDD] tab.

**[File] key and [Quick File] key**  
 The "File" key and/or "Quick File" key will not appear in the base screen of copy mode or image send mode if one or both of the keys has been changed to a different function using "Customize Key Setting" in the Web page menu. In this case, touch the [Special Modes] key in the base screen of either mode. Document filing can be performed by touching the [Quick File] key or [File] key in the special modes menu.

### Using document filing in print mode

To use document filing in print mode, select document filing in the printer driver. For more information on using document filing in print mode, see "[CONVENIENT PRINTER FUNCTIONS](#)" (page 3-52) in "3. PRINTER".

### Using document filing in PC-Fax/PC-I-Fax mode

To use document filing in PC-Fax or PC-I-Fax mode, select document filing settings in the PC-Fax driver. For more information, see Help in the PC-Fax driver.

**System Settings (Administrator): Customize Key Setting**  
 Registration is performed in [System Settings] - [Operation Settings] - "Customize Key Setting" in the Web page menu.



# BASE SCREEN OF DOCUMENT FILING MODE

Touch the [DOCUMENT FILING] key in the touch panel to open the base screen of document filing mode. Files stored on the hard drive in the machine can be retrieved from this screen.

When user authentication is used and My Folder is configured, the file selection screen of My Folder will appear. If the user that logged in does not have My Folder configured, the folder selection screen will appear.

☞ [FOLDER SELECTION SCREEN](#) (page 6-27)

☞ [FILE SELECTION SCREEN](#) (page 6-28)

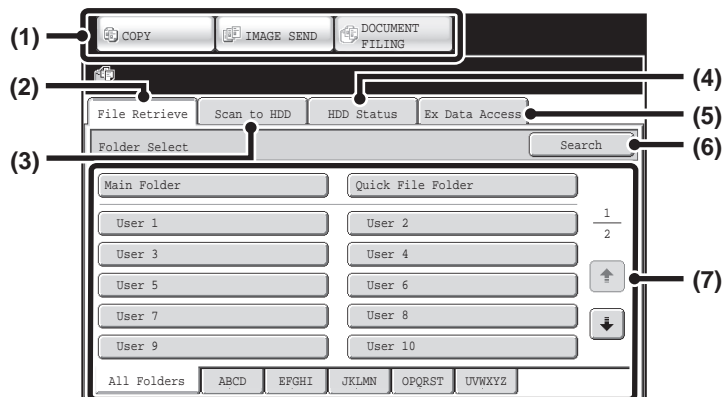

## (1) Mode switch keys

Use these keys to switch between copy, image send, and document filing modes.

To switch to document filing mode, touch the [DOCUMENT FILING] key.

## (2) [File Retrieve] tab

Touch this tab to retrieve a file stored by document filing. The folder selection screen will appear.

☞ [FOLDER SELECTION SCREEN](#) (page 6-27)

## (3) [Scan to HDD] tab

Touch this key to select Scan to HDD. Neither printing nor transmission are performed.

The file will be stored in the Main folder or a custom folder.

☞ [SAVING A DOCUMENT FILE ONLY \(Scan to HDD\)](#) (page 6-18)

## (4) [HDD Status] tab

Touch this key to check how much of the machine's hard drive is being used.

The amount used is shown as a percentage.

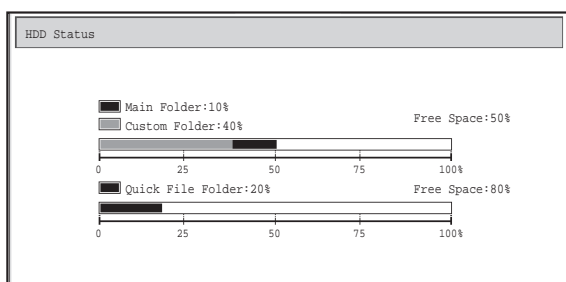

## (5) [External Data Access] tab

This can be selected when an FTP server is stored or a USB memory device is connected to the machine.

☞ ["DIRECTLY PRINTING FROM THE MACHINE"](#) (page 3-55) in "3. PRINTER"

## (6) [Search] key

Touch this key to search for a file stored in a folder. You can search using the user name, file name, or folder name.

☞ [SEARCHING FOR A STORED FILE](#) (page 6-48)

## (7) When retrieving a stored file, use this to select the folder where the file is stored.

☞ [FOLDER SELECTION SCREEN](#) (page 6-27)

# SAVING FILES WITH DOCUMENT FILING

This section explains how to save an original as an image file using the Quick File, File, and Scan to HDD functions of document filing mode.

## SAVING A FILE WITH "Quick File"

When copying, printing or transmitting a document in copy mode, print mode, or image send mode (excluding USB memory scan mode), "Quick File" can be selected to save an image of the document to the Quick File folder. The image can be retrieved at a later time, allowing you to print or transmit the document without having to locate the original.

As an example, the procedure for storing a document in the Quick File folder while copying is explained below.

### 1 Place the original.

Place the original face up in the document feeder tray, or face down on the document glass.

After placing the original, specify the original size.

#### Copy mode:

☞ [SPECIFYING THE ORIGINAL SIZE](#) (page 2-29)

#### Fax mode:

☞ [SPECIFYING THE SCAN SIZE AND SEND SIZE](#) (page 4-47)

#### Scanner/Internet Fax mode:

☞ [Specifying the send size of the image](#) (page 5-62)

### 2

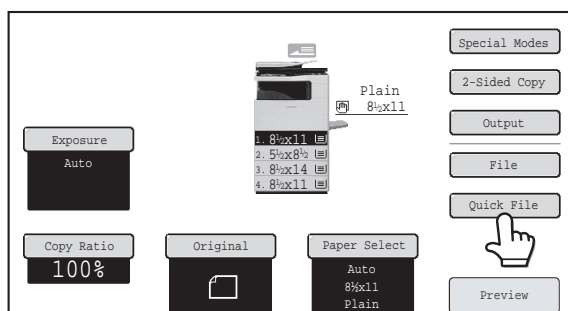

Touch the [Quick File] key.

3

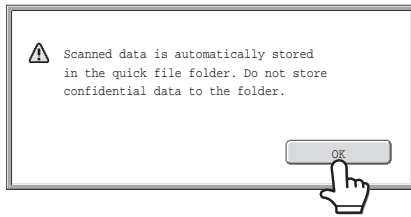

### Touch the [OK] key.

You will return to the base screen of copy mode and the [Quick File] key will be highlighted.



#### To cancel Quick File...

Touch the [Quick File] key in the screen of step 2 so that it is not highlighted after you touch the [OK] key.

4

### Select copy settings and then press the [START] key.

- Copying begins and the scanned document image is saved to the hard drive. The selected copy settings are also saved.
- To prevent accidental saving of the document, the message "The scanned data is stored in the quick file folder." appears for 6 seconds (default setting) after the [START] key is pressed. The message display time can be changed using "Message Time Setting" in the system settings (administrator).
- If you inserted the original pages in the document feeder tray, all pages are scanned.
- If you placed the original on the document glass, scan each page one page at a time. When scanning of one page finishes, replace it with the next page and press the [START] key. Repeat until all pages have been scanned and then press the [Read-End] key.



#### To cancel scanning...

Press the [STOP] key (Ⓢ).



When a file is stored using Quick File, the following user name and file name are automatically assigned to the file.

User Name: User Unknown

File Name: Mode\_Month-Day-Year\_Hour-Minute-Second  
(Example: Copy\_04042010\_112030AM)

Stored to: Quick File Folder

When user authentication is used, the user name that was used for login is automatically selected.

Only the file name and location of a file stored in the Quick File Folder can be changed.



#### To cancel Quick File...

Touch the [Quick File] key in the screen of step 2 so that it is no longer highlighted.



#### System Settings (Administrator): Delete All Quick Files

With the exception of protected files, all files in the quick file folder can be deleted at once.

Settings can be configured to delete all files by key operation and to have all files automatically deleted when the power is turned on.

# SAVING A FILE WITH "File"

When copying, printing or transmitting a document in copy mode, print mode, or image send mode (excluding USB memory scan mode), "File" can be selected to save an image of the document to the Main folder or a previously created custom folder. The image can be retrieved at a later time, allowing you to print or transmit the document without having to locate the original.

As an example, the procedure for using "File" while copying is explained below.

## 1 Place the original.

Place the original face up in the document feeder tray, or face down on the document glass. After placing the original, specify the original size.

### Copy mode:

 [SPECIFYING THE ORIGINAL SIZE](#) (page 2-29)

### Fax mode:

 [SPECIFYING THE SCAN SIZE AND SEND SIZE](#) (page 4-47)

### Scanner/Internet Fax mode:

 [Specifying the send size of the image](#) (page 5-62)

1

## 2 Touch the [File] key.

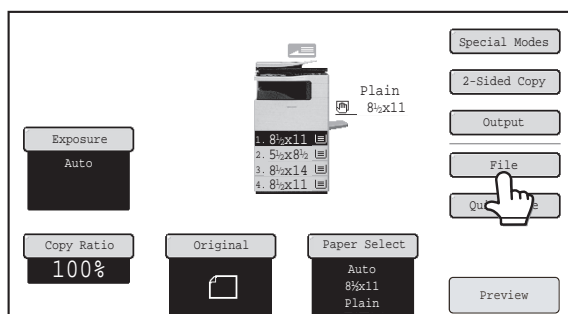

2

## 3 Select the "File" settings.

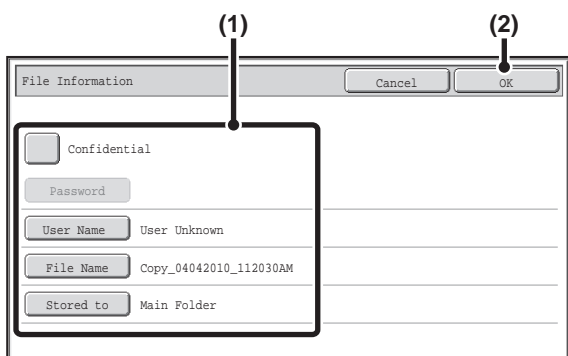

3

### (1) Select file information settings.

To select the user name, file name, folder, and confidential setting, see "FILE INFORMATION" (page 6-15).

- [Specifying a user name:](#) (page 6-15)
- [Assigning a file name:](#) (page 6-16)
- [Specifying the folder:](#) (page 6-16)
- [Storing a file as a confidential file:](#) (page 6-17)

After configuring the above settings, you will return to this screen. Go to the next step.

If you do not wish to assign a user name or other information to the file, go to the next step.

### (2) Touch the [OK] key.

You will return to the base screen of copy mode and the [File] key will be highlighted.

## 4

**Select copy settings and then press the [START] key.**

- Copying begins and the scanned document image is saved to the hard drive. The selected copy settings are also saved.
- For the procedure for placing the original, see step 4 of "[SAVING A FILE WITH "Quick File"](#)" (page 6-11).

**To cancel scanning...**

Press the [STOP] key (⏹).



When a file is stored using File without appending file information, the following user name and file name are automatically assigned to the file.

User Name: User Unknown

File Name: Mode\_Month-Day-Year\_Hour-Minute-Second  
(Example: Copy\_04042010\_112030AM)

Stored to: Main Folder

When user authentication is used, the user name that was used for login is automatically selected.

**To cancel the File operation...**

Touch the [Cancel] key in the screen of step 3.

# FILE INFORMATION

This section explains the settings that are configured in step 3 of "SAVING A FILE WITH "File"" (page 6-13). Specifying a user name, file name, folder, and confidential setting makes it easier to manage and search for a file. In addition, when confidential is selected and a password is established, other people will not be able to view the file without permission.

## Specifying a user name

1

### Touch the [User Name] key.

When user authentication is used, the user name that was used for login is automatically selected. In this case, this step is not needed.



The user name must be previously stored in "User List" in the system settings (administrator).

2

### Touch the desired user name in the list of user names that is displayed.

#### (1) Select the user name.

There are two ways to select the user name:

##### (A) Touch the key of the user name.

The touched user name is highlighted.

If you accidentally select the wrong user name, touch the key of the correct name.

##### (B) Touch the key.

An area for entering the "Registration No." [----] appears in the message display. Enter the "Registration No." set during user registration. This will allow you to select the user name.

#### (2) Touch the [OK] key.

The user name that you touched is selected and you return to the screen of step 1. The selected user name appears.

# Assigning a file name

A file name can be assigned to the file.

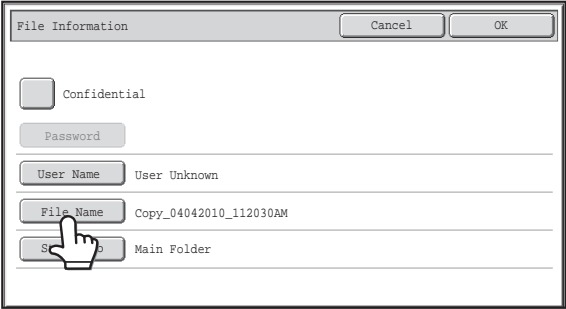

## Touch the [File Name] key.

A text entry screen will appear. Enter the file name and touch the [OK] key.

A maximum of 30 characters can be entered.

# Specifying the folder

1

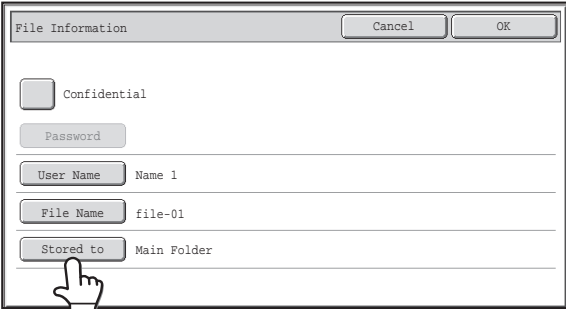

## Touch the [Stored to:] key.



If a user name with a "My Folder" setting is selected, "My Folder" of that user will automatically be selected.

2

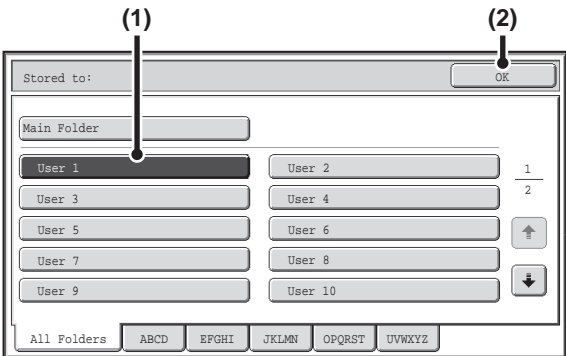

## Select the folder in which you want to store the file.

(1) Touch the key of the folder where you want to store the file.

If a password has been set for the folder, a password entry screen appears. Enter the password of the touched folder with the numeric keys (5 to 8 digits) and touch the [OK] key.

(2) Touch the [OK] key.

## Storing a file as a confidential file

A password can be set for the file to prevent others from viewing it. Set a password (5 to 8 digits) with the numeric keys.

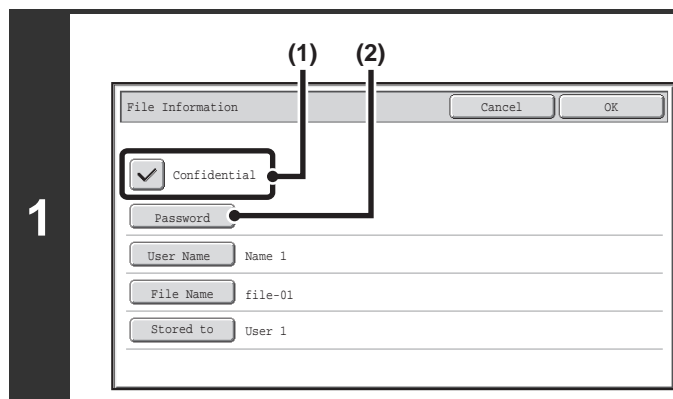

### Enable the confidential property.

- (1) Select the [Confidential] checkbox so that a checkmark  appears.**

Confidential mode is enabled and a password can be entered.

- (2) Touch the [Password] key.**

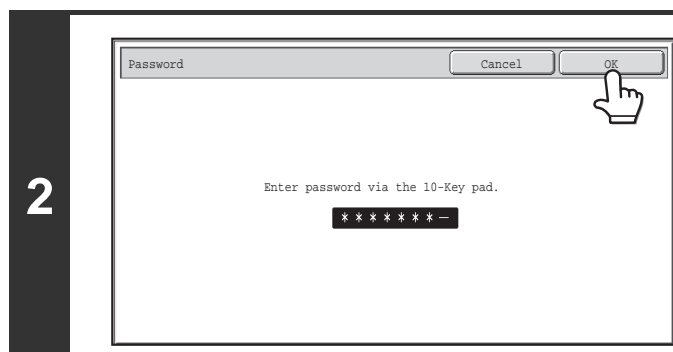

### Enter a password (5 to 8 digits) with the numeric keys and touch the [OK] key.

As each digit is entered, "-" changes to "\*".



# SAVING A DOCUMENT FILE ONLY (Scan to HDD)

Scan to HDD is used to store a scanned document in the Main folder or a custom folder. Neither printing nor transmission are performed.

## "Scan to HDD" SCREEN

The following screen appears when the [Scan to HDD] tab is touched in document filing mode. Touch the keys below to select Scan to HDD settings.

The current setting of each key appears to the right of the key.

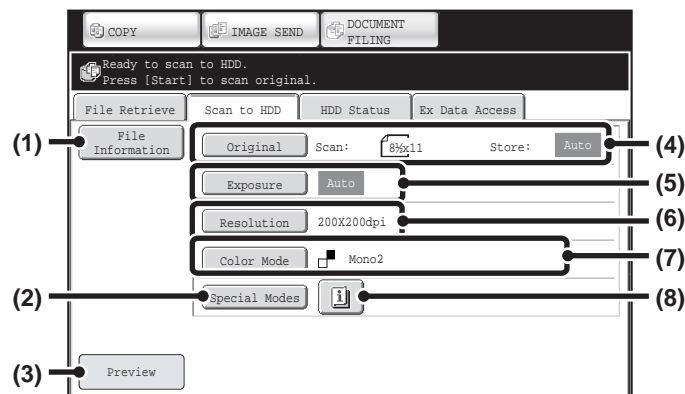

### (1) [File Information] key

Information can be appended to a file stored by Scan to HDD. The settings are configured in the same way as file information for "File".

➤ [FILE INFORMATION](#) (page 6-15)

### (2) [Special Modes] key

Use this key to select special modes for Scan to HDD.

➤ [Special modes screen for Scan to HDD](#) (page 6-21)

### (3) [Preview] key

Touch to check the image to be stored before performing Scan to HDD.

➤ [Checking the image before storing it \(Preview\)](#)  
(page 6-22)

### (4) [Original] key

Touch this key to set the scanning size, storing size and orientation of the original, and select 2-sided scanning settings.

➤ [\[Original\] key](#) (page 6-19)

### (5) [Exposure] key

Touch this key to select the exposure for scanning.

### (6) [Resolution] key

Use this key to select the resolution that will be used when the file is transmitted.

When "Long Size" is specified, only resolution settings of 300 X 300 dpi and under can be selected.

### (7) [Color Mode] key

Use this key to select the color mode when storing a document.

➤ [\[Color Mode\] key](#) (page 6-20)

### (8) key

This key appears when a special mode or 2-sided scanning is selected. Touch the key to display the selected special modes.

## [Original] key

When the [Original] key is touched, the following screen appears. This screen is used to change the original size and select scanning settings for 2-sided originals.

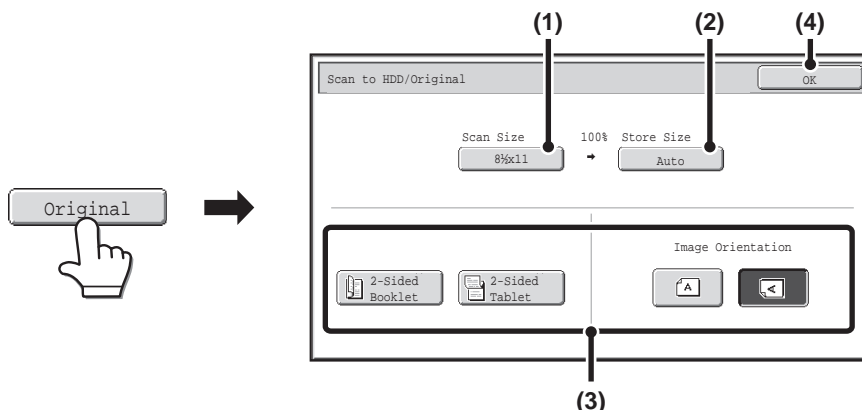

### (1) Touch the [Scan Size] key.

If the original is a non-standard size that cannot be detected by auto original size detection, touch the [Scan Size] key and specify the original size.

### (2) Touch the [Store Size] key.

If you wish to store the file at a different size than the original size, touch the [Store Size] key and change the store size.

### (3) Touch the appropriate orientation key.

If the top edge of the original is up, touch the key. If the top edge of the original is to the left, touch the key.

If the original is a 2-sided original, touch the [2-Sided Booklet] key or the [2-Sided Tablet] key as appropriate for the original type.

### (4) Touch the [OK] key.

The settings are stored and you return to the Scan to HDD screen.

## [Exposure] key

To adjust the exposure, touch the [Exposure] key.

Select an appropriate exposure mode for the original and touch the or key to adjust the exposure level.

When finished, touch the [OK] key.

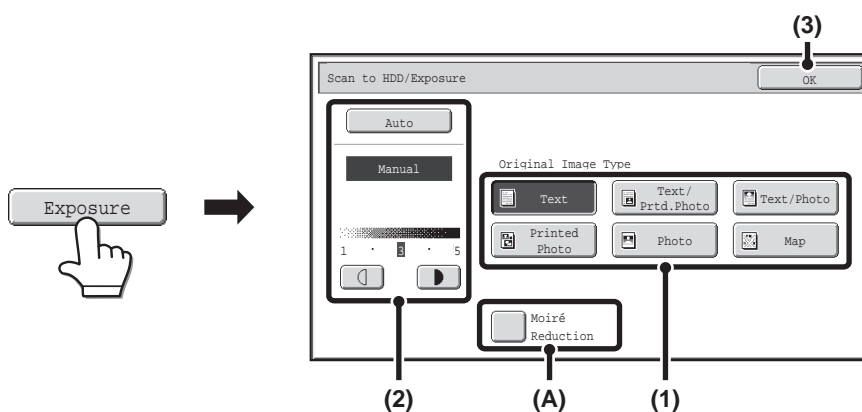

### (1) Select the appropriate original type for the original to be scanned.

### (2) Select [Auto] or [Manual].

If you selected [Manual], touch the or key to adjust the exposure. (For a darker image, touch the key. For a lighter image, touch the key.)

When the exposure is set to [Auto], the keys cannot be used.

#### (A): Moiré Reduction

To reduce the moiré effect when scanning printed matter, touch the [Moiré Reduction] checkbox so that a checkmark  appears.

### (3) Touch the [OK] key.

The settings are stored and you return to the Scan to HDD screen.

## [Color Mode] key

Touch the [Color Mode] key to open the color mode setting screen for Scan to HDD.

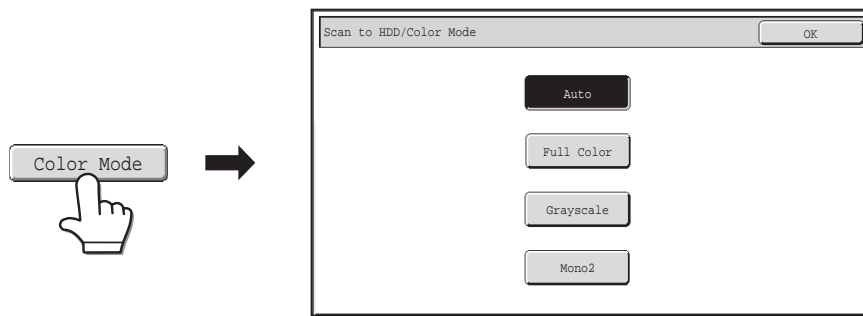

The following settings can be selected for the scanning color when the [START] key is pressed.

Mode	Scanning method
Auto	The machine detects whether the original is color or black and white and automatically selects full color or black and white (grayscale) scanning.
Full Color	The original is scanned in full color. This mode is best for full color originals such as catalogues. Even when the original is black and white, it is scanned as a full color original.
Grayscale	The colors in the original are scanned in black and white as shades of gray (grayscale).
Mono 2	Colors in the original are scanned as black or white. This mode is best for text-only originals.

When you have finished selecting the mode, touch the [OK] key.

## Special modes screen for Scan to HDD

When the [Special Modes] key is touched, the following screen appears. For more information on each setting, see "SPECIAL MODES" (page 5-74) in "5. SCANNER / INTERNET FAX".

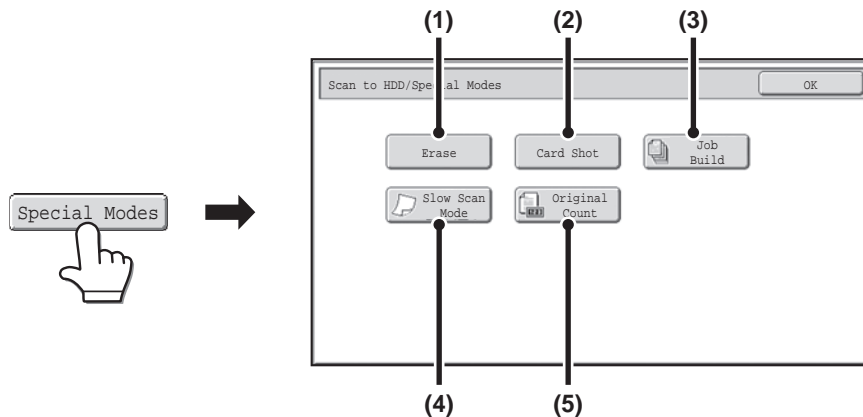

**(1) [Erase] key**

The erase function is used to erase shadow lines on images produced when scanning thick originals or books on the document glass.

**(2) [Card Shot] key**

This function lets you store the front and reverse sides of a card as a single file.

**(3) [Job Build] key**

This function lets you separate a many-page original into sets, scan each set using the automatic document feeder, and store all pages as a single file. Use this function when there are more original pages than can be placed at once in the auto document feeder.

**(4) [Slow Scan Mode] key**

Use this function when you wish to scan thin originals using the automatic document feeder. This function helps prevent thin originals from misfeeding.

**(5) [Original Count] key**

When using the automatic document feeder to scan an original, you can check whether or not the correct number of pages were scanned before storing the document.

## Checking the image before storing it (Preview)

If you touch the [Preview] key and then start Scan to HDD, the screen below appears.

Before the scanned data is stored, you can check a preview of the scanned image in this screen and return to the Scan to HDD settings screen to change settings

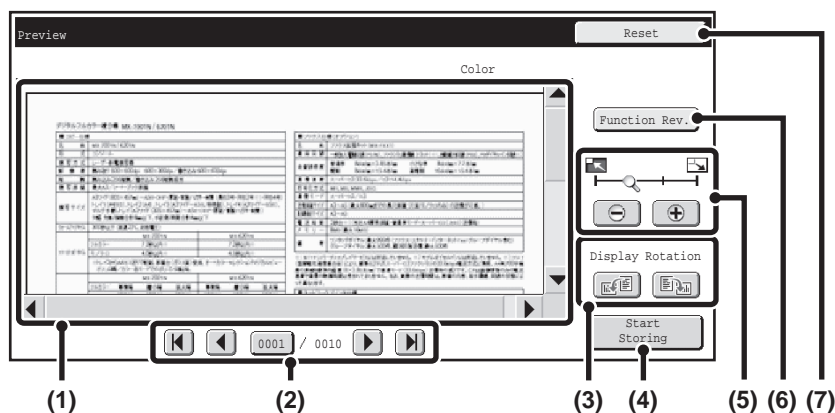

### (1) Preview image

This shows an image of the selected file.  
If the image is cut off, use the scroll bars at the right and bottom of the screen to scroll the image. Touch a bar and slide it to scroll. (You can also touch the keys to scroll.)

### (2) Change page keys

When there are multiple pages, use these keys to change pages.

- keys: Go to the first or the last page.
- keys: Go to the previous page or the next page.
- Page number display: This shows the total number of pages and the current page number. You can touch the current page number key and enter a number with the numeric keys to go to that page number.

### (3) "Display Rotation" key

This rotates the image right or left by 90 degrees. The rotation applies to all pages in the file, not just the displayed page.

### (4) [Start Storing] key

This starts Scan to HDD.

### (5) Display zoom key

Use this to set the zoom ratio of the displayed image. Changes from the left in the order "Full Page", "Twice", "4 Times", "8 Times". The setting applies to all pages in the file, not just the displayed page.

### (6) [Function Rev.] key

Use this to check special mode settings and original settings.

### (7) [Reset] key

Use this key if you need to change settings after checking an image or settings. You will return to the setting screen.  
Only the original settings can be changed after the preview image is viewed.



- A preview image is an image for display on the touch panel. Differs from the actual storage result.
- Depending on the size of the image, part of the image may be clipped off in the preview screen on the touch panel.

# PERFORMING "Scan to HDD"

1

## Place the original.

Place the original face up in the document feeder tray, or face down on the document glass.

### Placing the original on the document glass

#### Portrait original

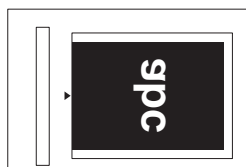

Align the top edge of the original against the side of the document glass with the scale.

#### Landscape original

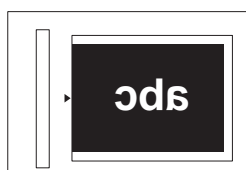

Align the right side of the original against the side of the document glass with the scale.

2

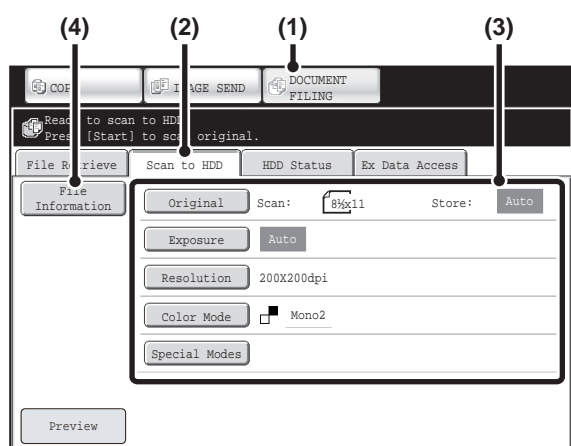

## Switch to document filing mode and select Scan to HDD settings.

- (1) Touch the [DOCUMENT FILING] key.
- (2) Touch the [Scan to HDD] tab.  
If you do not wish to select settings, go to the next step.
- (3) Select the original size, exposure, resolution, color mode, and special modes.  
See "'Scan to HDD' SCREEN" (page 6-18).
- (4) Touch the [File Information] key.  
The settings are the same as for "File". See "FILE INFORMATION" (page 6-15).



If the original is 2-sided, be sure to touch the [Original] key and then touch the [2-Sided Booklet] key or the [2-Sided Tablet] key as appropriate for the original.

3

## Press the [START] key.

Scanning begins.

For the procedure for placing the original, see step 4 of "SAVING A FILE WITH "Quick File"" (page 6-11).

When Preview is enabled, the preview screen appears.

➡ [Checking the image before storing it \(Preview\)](#) (page 6-22)

A beep will sound to indicate that Scan to HDD is completed.



### To cancel scanning...

Press the [STOP] key (⏹).

 When Scan to HDD is performed without appending file information, the following user name and file name are automatically assigned to the file.

User Name: User Unknown

File Name: Mode\_Month-Day-Year\_Hour-Minute-Second  
(Example: HDD\_04042010\_112030AM)

Stored to: Main Folder

When user authentication is used, the user name that was used for login is automatically selected.

# USING STORED FILES

This section explains how to retrieve a file stored by document filing and print or transmit the file.

## SEQUENCE FOR USING A STORED FILE

This section explains the basic procedure for retrieving and using a stored file. The screens and procedures differ depending on whether or not user authentication is enabled.

See the sequence that applies to your situation.

For information on user authentication procedures, see "[USER AUTHENTICATION](#)" (page 1-17) in "1. BEFORE USING THE MACHINE". For information on enabling user authentication and storing user names, see "[User Control](#)" (page 7-51) in "7. SYSTEM SETTINGS".

 Files stored by document filing can also be retrieved and used from the Web pages. Click [Document Operation] and then [Document Filing] in the Web page menu, and select the folder that contains the file you wish to use. You can also show a preview of a stored file in the web pages.

### Change the mode.

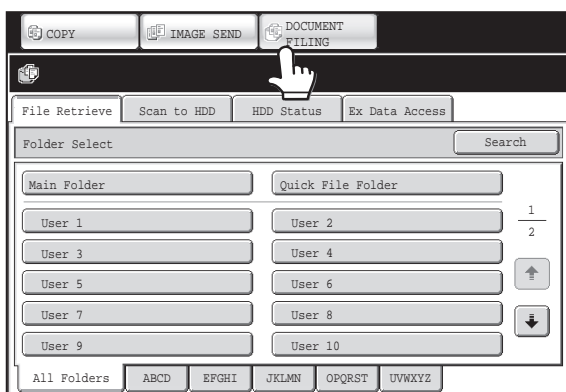

Switch to document filing mode.

 [BASE SCREEN OF DOCUMENT FILING MODE](#) (page 6-10)



## Select the file that you wish to retrieve.

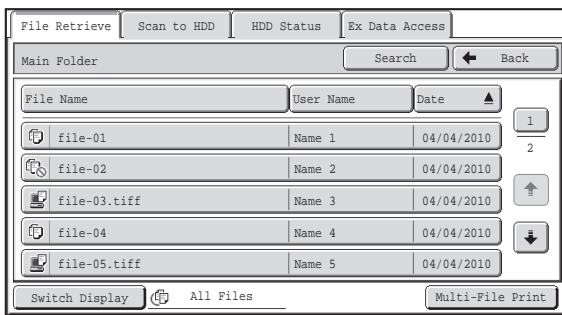

- Select the folder in the folder selection screen. When the folder is selected, the files in the folder will appear. Select the file that you wish to retrieve.
- Thumbnail images of the stored files can be displayed for file selection.
  - ☞ [FILE SELECTION SCREEN](#) (page 6-28)
  - ☞ [SELECTING A FILE](#) (page 6-30)
- The search function can be used to retrieve a file.
  - ☞ [SEARCHING FOR A STORED FILE](#) (page 6-48)



## Select the operation.

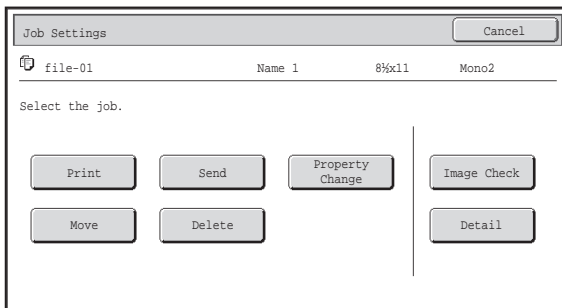

Select the desired operation and configure settings.

- ☞ [JOB SETTINGS SCREEN](#) (page 6-31)
- ☞ [PRINTING A STORED FILE](#) (page 6-32)
- ☞ [SENDING A STORED FILE](#) (page 6-38)
- ☞ [PROPERTIES OF STORED FILES](#) (page 6-40)
- ☞ [MOVING A STORED FILE](#) (page 6-42)
- ☞ [DELETING A STORED FILE](#) (page 6-44)
- ☞ [CHECKING AN IMAGE OF A STORED FILE](#) (page 6-45)

# FOLDER AND FILE SELECTION SCREENS

To use a file stored by document filing, the folder and file must be selected. The folder selection screen and file selection screen are explained below.

## FOLDER SELECTION SCREEN

Two different screens appear depending on whether or not user authentication is enabled on the machine.

### When user authentication is not enabled

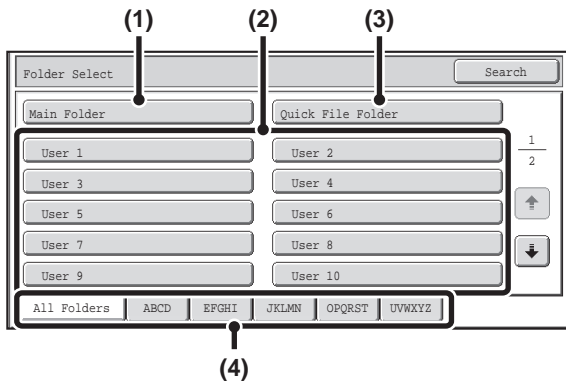

### When user authentication is enabled

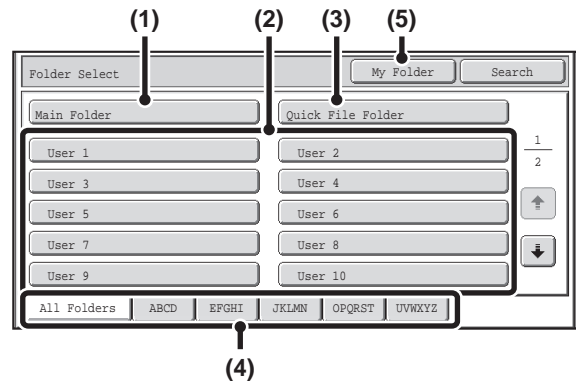

**(1) [Main Folder] key**

Touch this key to retrieve a file from the Main folder. The files in the Main folder will appear.

**(2) Custom folder keys**

The custom folders that have been created using "[Document Filing Control](#)" (page 7-29) in system settings are displayed. Touch a key to display the files in that folder.

If a password has been set for a custom folder, a password entry screen will appear when the folder is touched. The password must be entered.

**(3) [Quick File Folder] key**

Touch this key to retrieve a file from the Quick File folder. The files in the Quick File folder will appear.

[SAVING A FILE WITH "Quick File"](#) (page 6-11)

**(4) Index tabs**

All folders appear on the [All Folders] tab.

Touch a tab to display the custom folders whose initials (set in "Document Filing Control" in the system settings) match the letters on the tab.

**(5) [My Folder] key**

This key appears when user authentication is enabled. Touch the key to display the file selection screen of "My Folder".

# FILE SELECTION SCREEN

The file selection screen of the Quick File folder, Main folder, and custom folders is explained below.

The file selection screen can be displayed in "List screen" format or "Thumbnail screen" format. (To select the format, see "(5) [Switch Display] key" below.)

This chapter assumes that the "List screen" format is selected.

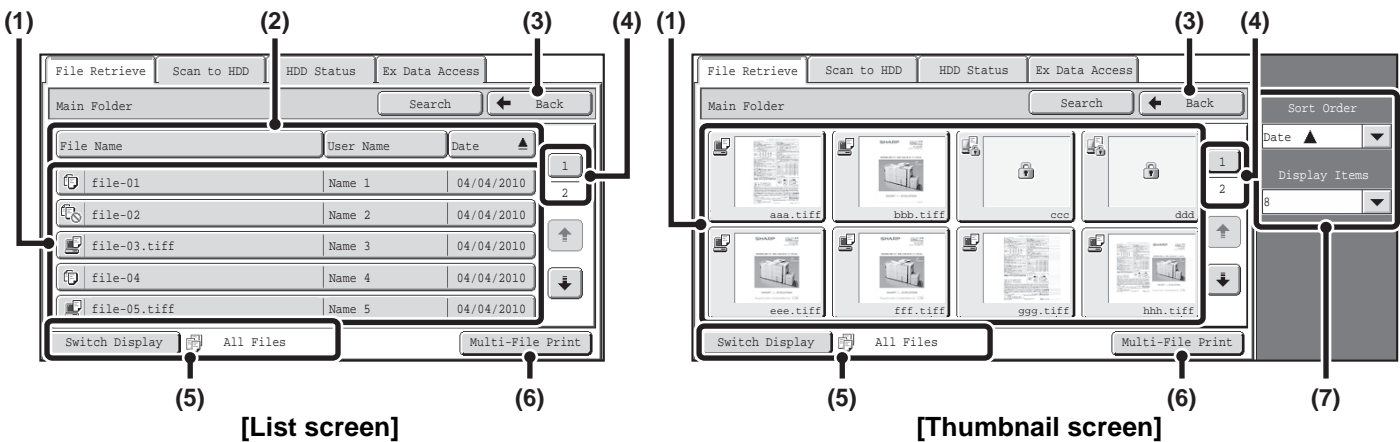

## (1) File keys

The stored files are displayed. An icon showing which mode the file was stored from, the file name, the user name, and the date the file was stored appear in each file key.

When a file is touched, the job setting screen appears.

### Job icons

	Copy		Internet fax transmission		Print
	Fax transmission		Scan to E-mail		Scan to HDD
	Scan to FTP		Scan to Desktop		Scan to Network Folder
	PC-Fax transmission		PC-I-Fax transmission		Broadcast transmission

### Thumbnail screen

The first page of thumbnail images of the stored files appears.

The confidential icon (🔒) will appear instead of a thumbnail image for files stored as confidential files.

## (2) [File Name] key, [User Name] key, [Date] key

Use these keys to change the order of display of the file keys. When one of the keys is touched, ▲ or ▼ appears in the key.

- When ▲ appears in the [File Name] key or [User Name] key, the files appear by file name or user name in ascending order.  
When ▲ appears in the [Date] key, the files appear in order from the oldest date.
- When ▼ appears in the [File Name] key or [User Name] key, the files appear by file name or user name in descending order.  
When ▼ appears in the [Date] key, the files appear in order from the most recent date.

## (3) [Back] key

Touch this key to return to the base screen of document filing mode.

➡ [FOLDER SELECTION SCREEN](#) (page 6-27)

## (4) Page key

When multiple pages exist, use this key to enter the number of a page that you want to display. When the key is touched, a page number entry screen appears. Enter the desired page number (3 digits) with the numeric keys. For example, to display page 3, enter "003".

## (5) [Switch Display] key

The displayed file keys can be changed by job type and can be displayed as thumbnail images. The currently selected job type appears to the right of the [Switch Display] key. [All Files] is initially selected. When the [Switch Display] key is touched, the following screen appears.

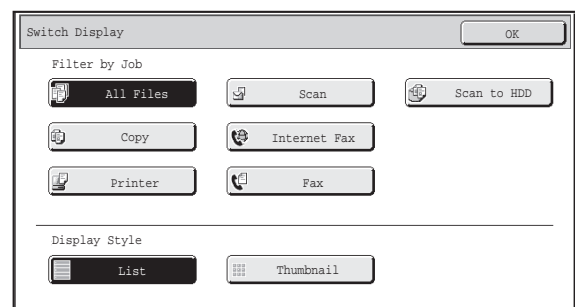

If you wish to display only the file keys of a specific job type, select the job type from the job type display at the top of the screen.

To display thumbnail images of the files, touch the [Thumbnail] key. To change from the thumbnail screen to the list screen, touch the [List] key. When finished, touch the [OK] key.

**(6) [Multi-File Print] key**

Touch this to select multiple files in a folder for printing.

 [MULTI-FILE PRINTING](#) (page 6-34)

**(7) Sort Order / Display Items**

This can be used in the thumbnail screen.

The order of display of the file thumbnails can be changed in "Sort Order".

Select "Date ▲", "Date ▼", "File Name ▲", "File Name ▼", "User Name ▲", or "User Name ▼".

The number of displayed file thumbnails can be changed in "Display Items".

Select 2 thumbnails or 8 thumbnails.

# SELECTING A FILE

This section explains how to select a file to be used.

1

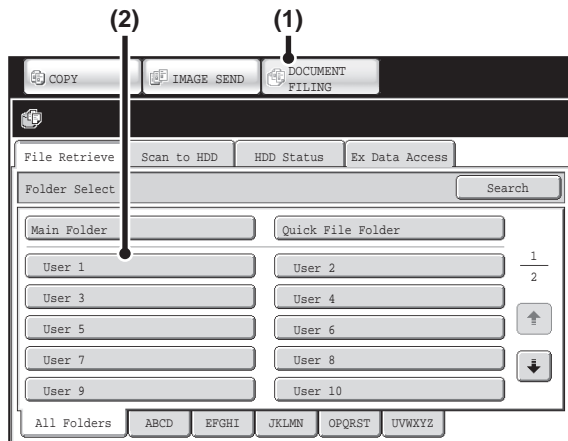

**Select the folder that contains the file you wish to use.**

**(1) Touch the [DOCUMENT FILING] key.**

The folder selection screen will appear. If a different tab appears, touch the [File Retrieve] tab.

When user authentication is enabled and "My Folder" is configured in "User List" in the system settings, the custom folder specified as "My Folder" opens. To display the folder selection screen, touch the [Back] key.

**(2) Touch the key of the folder that contains the desired file.**

If a password is set for the selected folder, a password entry screen will appear.

Enter the password with the numeric keys (5 to 8 digits) and touch the [OK] key.

2

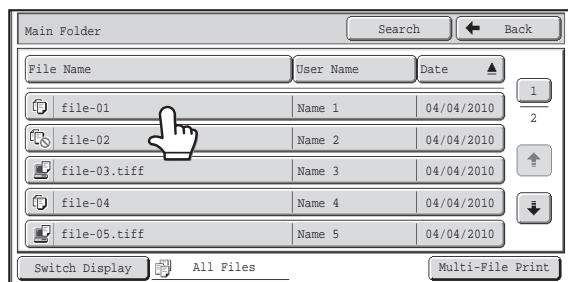

**Touch the key of the desired file.**

If a password is set for the selected file, a password entry screen will appear.

Enter the password with the numeric keys (5 to 8 digits) and touch the [OK] key.



- Touch the [Switch Display] key to display the keys of a particular mode such as copy or scanner mode, or to display thumbnail images of the files.  
The [Switch Display] key allows you to quickly find a file.
- You can touch the [File Name] key, the [User Name] key, or the [Date] key to change the order of display of the files.
- The [Multi-File Print] key can be touched to select multiple files in a folder for printing.

📄 [MULTI-FILE PRINTING](#) (page 6-34)

# JOB SETTINGS SCREEN

When a file key is touched, the following screen appears. Touch the key of the operation that you wish to perform and select settings.

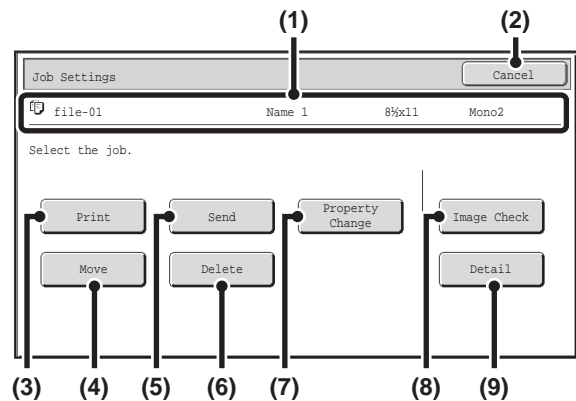
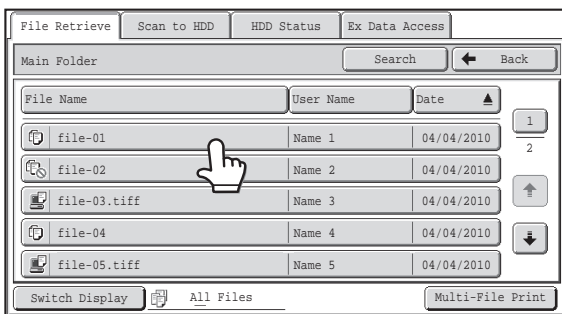

## (1) File display

This shows information on the currently selected file (job icon, file name, user name, store size, and color mode).

## (2) [Cancel] key

Touch this key to cancel the operation and return to the file selection screen.

## (3) [Print] key

Touch this key to print the selected file.

➤ [PRINTING A STORED FILE](#) (page 6-32)

## (4) [Move] key

Use this procedure to change the location of a file (move a file to a different folder).

➤ [MOVING A STORED FILE](#) (page 6-42)

## (5) [Send] key

This is used to send a stored file by fax, Internet fax, scan send, or other method.

➤ [SENDING A STORED FILE](#) (page 6-38)

## (6) [Delete] key

Touch this key to delete a file that is no longer needed.

➤ [DELETING A STORED FILE](#) (page 6-44)

## (7) [Property Change] key

Use this key to change the property ("Sharing", "Protect", or "Confidential") of a stored file.

➤ [PROPERTIES OF STORED FILES](#) (page 6-40)

## (8) [Image Check] key

An image of the stored file appears.

➤ [CHECKING AN IMAGE OF A STORED FILE](#) (page 6-45)

## (9) [Detail] key

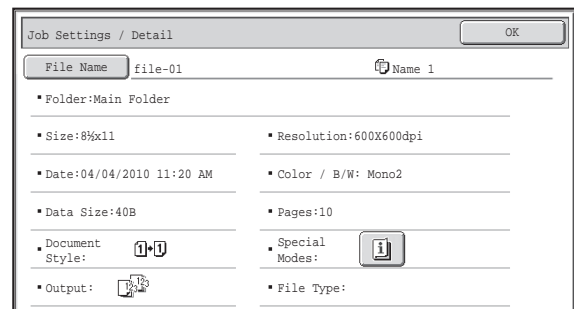

Touch this key to show detailed information on the selected file.

When this key is touched, the following screen appears.



If you wish to change the file name, touch the [File Name] key in this screen.

A text entry screen will appear. Enter the desired file name.

The  key appears when a special mode is selected. Touch the  key to display the special mode selection confirmation screen.

# PRINTING A STORED FILE

A file stored using document filing can be retrieved and printed when needed. The settings used when the file was stored are also stored, and thus the file can be printed again using those settings. The file can also be modified before printing by changing the print settings.

After selecting the desired file, follow the steps below.

☞ [SELECTING A FILE](#) (page 6-30)

1

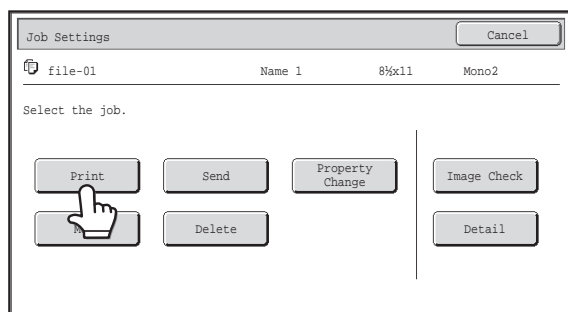

Touch the [Print] key.

2

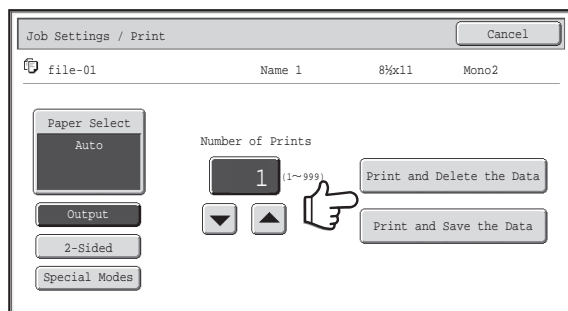

Touch the [Print and Delete the Data] key or the [Print and Save the Data] key.

If the [Print and Delete the Data] key is touched, the files will be automatically deleted after printing.

If the [Print and Save the Data] key is touched, the files will be saved after printing.

Output settings, 2-sided printing, special modes, the number of copies, and other settings can be selected. For more information, see "[PRINT SETTINGS SCREEN](#)" (page 6-33).



- When a long size document is stored from Scan to HDD or scan mode, the file cannot be printed. A file stored from scan mode that included fax mode or Internet fax mode destinations in a broadcast transmission can be printed.
- If print settings are changed when a stored file is printed, the only changed setting that can be stored is the number of copies.
- The printing speed may be somewhat slow depending on the resolution and exposure mode settings of the stored file.

# PRINT SETTINGS SCREEN

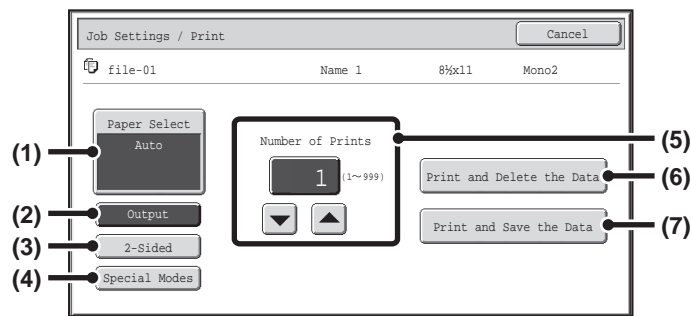

## (1) [Paper Select] key

Use this key to set the paper size.

## (2) [Output] key

Use this key to select Sort, Group or Staple Sort, and to select the output tray.

## (3) [2-Sided] key

Use this key to select the orientation of the image on the reverse side of the paper for 2-sided printing. To have the front and back images oriented in the same direction, touch the [2-Sided Booklet] key. To have the front and back images oriented opposite to each other, touch the [2-Sided Table] key. Note that the size and orientation of the saved image may cause these keys to have the opposite effect. If neither of these keys is selected (neither is highlighted), 1-sided printing will take place.

## (4) [Special Modes] key

Touch this key to select "Margin Shift", "Pamphlet Style", "2in1", or "Stamp".

This key does not appear if the file was saved from print mode.

## (5) [Number of Prints] key

Use these keys to set the number of copies. The number of copies can also be selected by directly touching the numeric display and changing the number with the numeric keys.

## (6) [Print and Delete the Data] key

Printing begins when this key is touched. When printing is finished, the file will be automatically deleted.

## (7) [Print and Save the Data] key

Printing begins when this key is touched. The file will not be deleted after printing.



# MULTI-FILE PRINTING

Multiple files in a folder can be selected for printing.

1

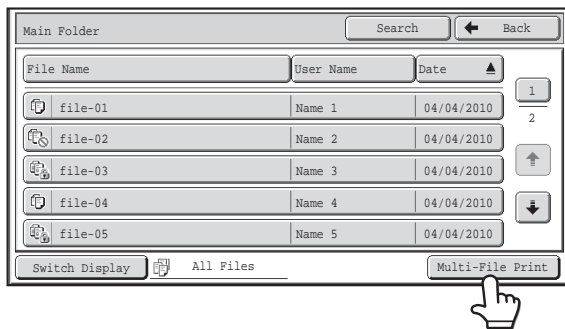

## Touch the [Multi-File Print] key.

To select files of a particular job type, touch the [Switch Display] key, select the job type from the screen that appears, and touch the [OK] key.

Touch the [Switch Display] key to show only files of a selected job type.

2

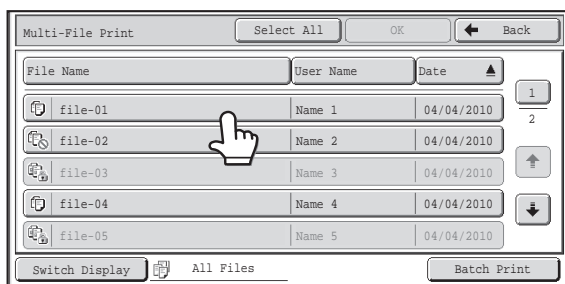

## Select the keys of the files that you wish to print.

Touch the keys of the files that you wish to print. Touched file keys will be highlighted to indicate that they have been selected.

To cancel the selection of a file, touch the highlighted file key so that it is no longer highlighted.

To select all displayed file keys except those of confidential files, touch the [Select All] key.

The [Batch Print] key can be used to print all files of a particular user in a folder or all files that have the same password in a folder. For more information, see "[Batch printing](#)" (page 6-36).



- Multi-file printing of confidential files is not possible.
- A file in the currently selected folder cannot be selected simultaneously with a file in a different folder.
- If the job type is changed with the [Switch Display] key or the screen is changed with the [Back] key while a file is selected, the selection of the file will be canceled.
- When the [Select All] key is touched, it will change into the [Cancel All] key. To cancel the selection of all files that was made with the [Select All] key, touch the [Cancel All] key.
- If all files are selected without using the [Select All] key, the key will not change into the [Cancel All] key. If selection of all files is canceled without using the [Cancel All] key, the key will remain the [Cancel All] key.

3

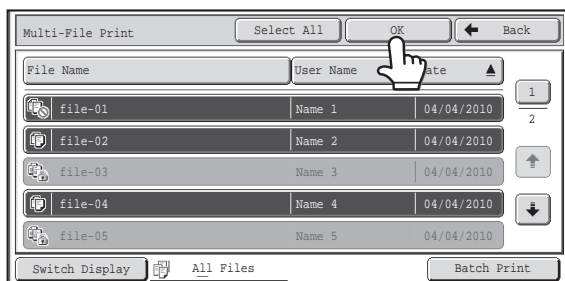

## Touch the [OK] key

The selected file is entered and the screen changes to the print screen.

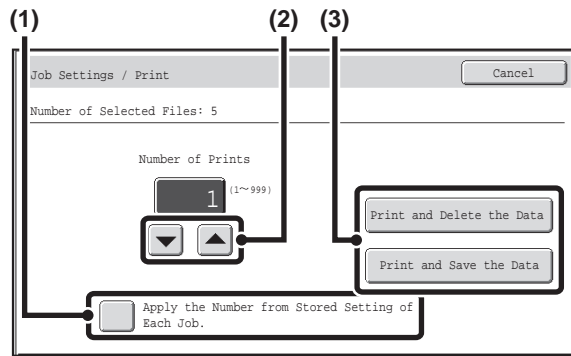

## Printing a selected file.

The number of selected files appears in the number of selected files display.

If you wish to use the number of copies that was stored with the file, go to step (3).

- (1) Touch the [Apply the Number from Stored Setting of Each Job] checkbox so that it is not selected () .
- (2) Set the number of copies with the   keys.
- (3) Touch the [Print and Delete the Data] key or the [Print and Save the Data] key.

If the [Print and Delete the Data] key is touched, the files will be automatically deleted after printing.

If the [Print and Save the Data] key is touched, the files will be saved after printing.

## Batch printing

All files in a folder that have the same user name and password can be printed at once. When the [Multi-File Print] key is touched, it changes into the [Batch Print] key.

1

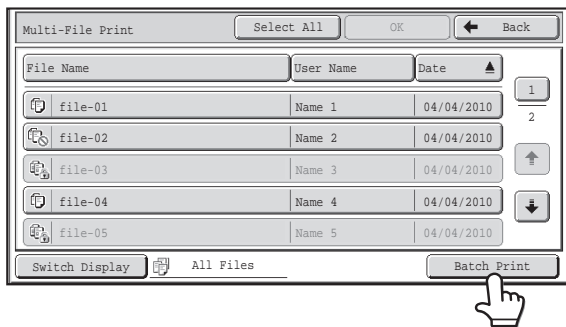

Touch the [Batch Print] key.

2



Touch the [User Name] key.

When user authentication is used, the user name that was used for login is automatically selected.

3

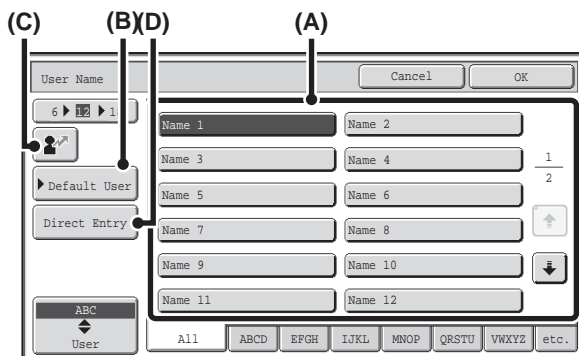

Select the user name.

There are four ways to select the user name:

**(A) Touch the key of the user name.**

The touched user name is highlighted.

If you accidentally select the wrong user name, touch the key of the correct name.

**(B) Touch the [Default User] key.**

The user name can be selected from the factory stored users.

**(C) Touch the  key.**

An area for entering the "Registration No." [----] appears in the message display. Enter the "Registration No." set during user registration. This will allow you to select the user name.

**(D) Touch the [Direct Entry] key.**

A text entry screen appears. Directly enter the user name. After selecting the user name, touch the [OK] key.



When [Selection of [All Users] is not allowed] checkbox and [Selection of [User Unknown] is not allowed] checkbox are disabled in the system settings (administrator), the [All Users] key and [User Unknown] key can be selected. The [All Users] key can be touched to select all files in the folder (the files of all users). The [User Unknown] key can be touched to select all files in the folder that do not have a user name.

4

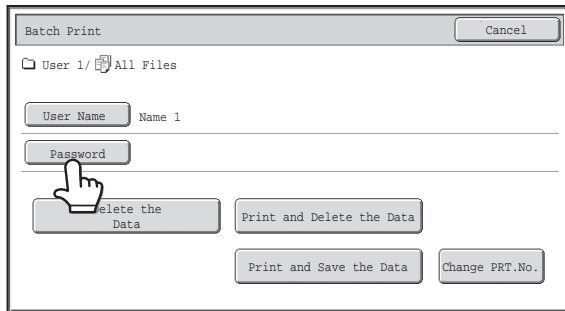

### If a password has been established, touch the [Password] key.

Enter the password with the numeric keys (5 to 8 digits) and touch the [OK] key. Only files that have the same password will be selected.

If you do not wish to enter a password, go to the next step.

5

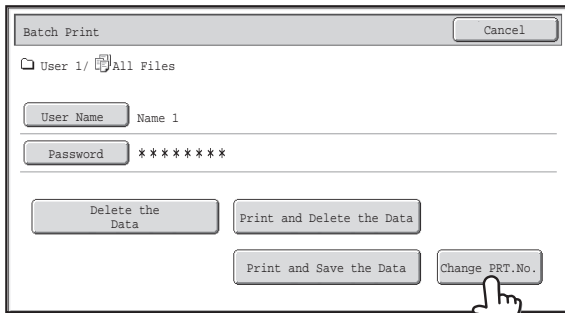

### To set the number of copies, touch the [Change PRT.No.] key.

If you wish to use the number of copies stored with each file, go to step 6.

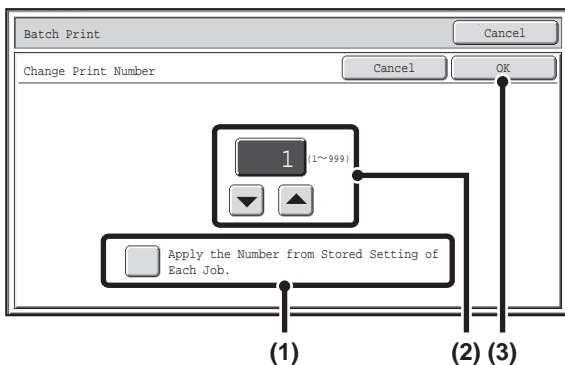

(1) Touch the [Apply the Number from Stored Setting of Each Job] checkbox so that it is not selected () .

(2) Set the number of copies with the   keys.

You can also directly touch the numeric display and change the number with the numeric keys.

(3) Touch the [OK] key.

6

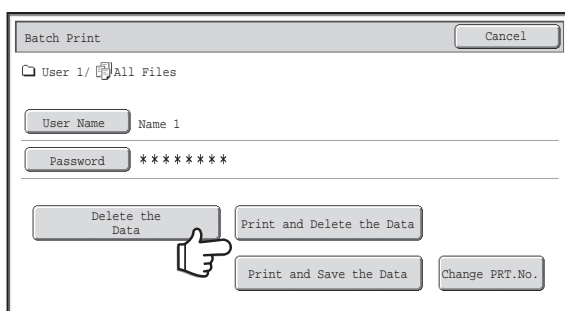

### Touch the [Print and Delete the Data] key or the [Print and Save the Data] key.

If the [Print and Delete the Data] key is touched, the files will be automatically deleted after printing.

If the [Print and Save the Data] key is touched, the files will be saved after printing.

If there are no files that match the search conditions, you will return to the file list screen.



All files that match the current search conditions can be deleted by touching the [Delete the Data] key.

# SENDING A STORED FILE

A file stored by document filing can be retrieved and transmitted whenever needed. The settings used when the file was stored are also stored, and thus the file can be transmitted using those settings. If needed, you can also change the transmission settings to modify the retrieved file.

After selecting the desired file, follow the steps below.

☞ [SELECTING A FILE](#) (page 6-30)

1

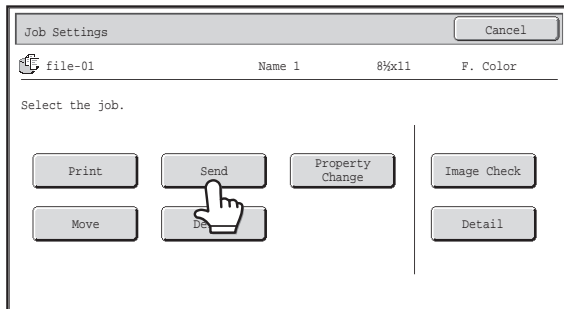

Touch the [Send] key.

2

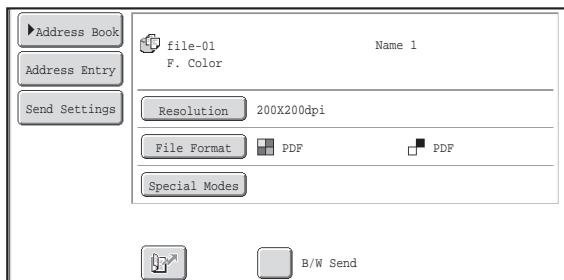

Select transmission settings.

For information on the settings, see "[SEND SETTINGS SCREEN](#)" (page 6-39).

3

Press the [START] key.



- A stored print job cannot be transmitted.
- These transmission methods require installation of the corresponding options.
- If any of the following special modes were included in the saved file, the file cannot be transmitted. "Pamphlet Copy", "Photo Repeat", "2in1" for copying.
- If any of the following special modes were included in the saved file, the file can be transmitted but the special modes will not be executed. "Margin Shift", "Transparency Inserts", "Stamp", "Sharpness", "Centering"
- Depending on the reduction or enlargement ratio used when storing a file, it may not be possible to send the stored file using a selected resolution setting. In this event, try changing the resolution. However, when sending a stored file by Internet fax, transmission may not be possible even if the resolution is changed.

# SEND SETTINGS SCREEN

The keys that appear in the send settings are explained below. For more information on each of the settings, see "BASE SCREEN OF FAX MODE" (page 4-7) in "4. FACSIMILE" and "BASE SCREEN" (page 5-9) in "5. SCANNER / INTERNET FAX".

## Example of scan mode

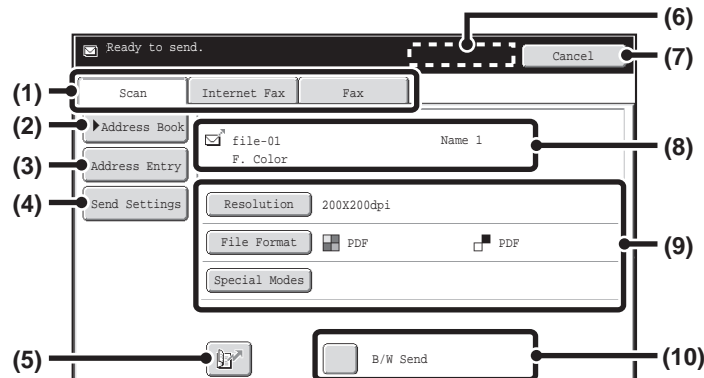

### (1) Send mode tabs

Touch the appropriate tab to select fax mode, scan mode, Internet fax mode, etc.

### (2) [Address Book] key

Touch this key to display the destinations stored in the address book.

### (3) [Address Entry] key or [Sub Address] key

Use this key to directly enter an address when sending a file in scan mode or Internet Fax mode. In fax mode this appears as the "Sub Address" key. Use this key to enter a sub-address and password for F-code communication.

### (4) [Send Settings] key

This key appears in scan mode and Internet fax mode. Touch the key to enter a subject and a file name when performing a transmission. In scan mode, a sender can also be specified.

### (5) key

The 3-digit search number that was assigned to a one-touch key or group key when the key was stored can be entered to specify a destination.

### (6) [Next Address] key

This key appears when at least one address has been entered. Use this key when you are sending a file to multiple destinations.

### (7) [Cancel] key

This returns you to the job settings screen.

### (8) File name / User name display

This shows the icon of the file to be sent, the file name, the user name, and the color mode (color/black & white).

### (9) Any of these keys can be touched to change the corresponding settings of the file to be sent. The settings that can be selected vary by mode.

#### • Scan mode

##### [Resolution] key

Use this to select the resolution. A resolution setting higher than the resolution at which the file was stored cannot be selected.

##### [File Format] key

This lets you select the file type, compression ratio, and color mode.

##### [Special Modes] key

This displays the [Timer] key.

#### • Internet fax mode

##### [Resolution] key

Use this to select the resolution. A resolution setting higher than the resolution at which the file was stored cannot be selected.

##### [File Format] key

Use this to select the file type and compression ratio.

##### [Special Modes] key

This displays the [Timer] and [Transaction Report] keys.

#### • Fax mode

##### [Resolution] key

Use this to select the resolution. A resolution setting higher than the resolution at which the file was stored cannot be selected.

##### [Special Modes] key

This displays the [Timer], [Own Name Select], and [Transaction Report] keys.

### (10) [B/W Send] checkbox

This is used to resend a full color file. To send a black & white file, select the checkbox . This function cannot be used for a fax or Internet Fax file.



# PROPERTIES OF STORED FILES

## FILE PROPERTIES

A protect setting can be selected for files saved with the document filing function. This prevents a file from being moved, or automatically or manually deleted.

Three properties are available for saved files: [Sharing], [Protect], and [Confidential]. When saved with the [Sharing] property, a file is not protected. When saved with the [Protect] or [Confidential] property, a file is protected.

Files saved to the Quick File folder are all saved as [Sharing] files. When a file is saved to the Main folder or a custom folder, [Sharing] or [Confidential] can be selected.

<b>Sharing</b>	A [Sharing] file can be changed to [Protect] or [Confidential] using [Property Change] in the Job Settings.
<b>Protect</b>	"Protect" prevents a file from being moved or deleted. A password cannot be established. The  icon appears with the mode icon in the file key of a protected file.
<b>Confidential</b>	To protect a "Confidential" file, a password is set. (The password must be entered to retrieve the file.) The  icon appears with the mode icon in the file key of a confidential file.

## CHANGING THE PROPERTY

After selecting the desired file, follow the steps below.

 [SELECTING A FILE](#) (page 6-30)

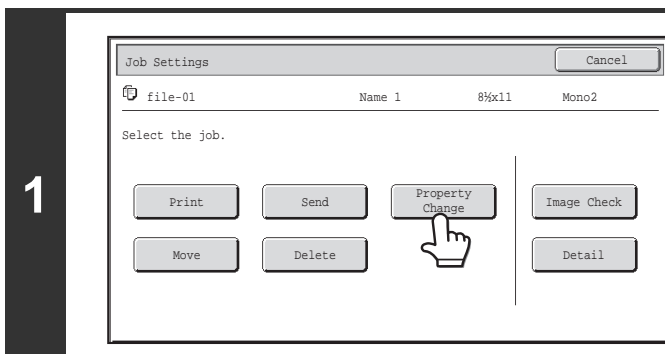

Touch the [Property Change] key.

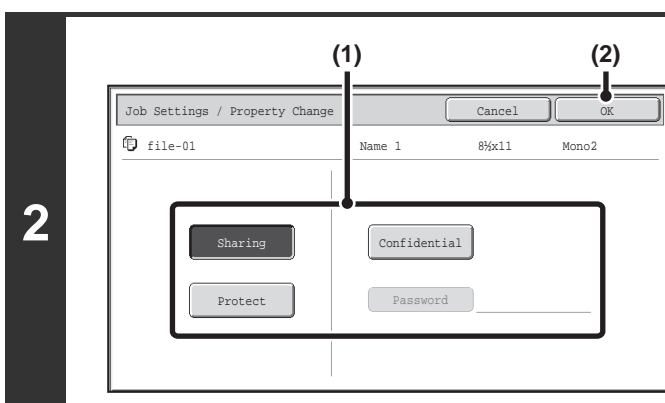

Select the property.

(1) Touch the key of the desired property.

When the [Confidential] key is touched, the [Password] key can be touched.

Touch the [Password] key, enter a password (5 to 8 digits) with the numeric keys, and touch the [OK] key.

(2) Touch the [OK] key.

**Restrictions on changing the property**

- A file that is set to "Sharing" can be changed to "Protect" or "Confidential". However, a "Sharing" file that is saved in the Quick File folder can only be changed to "Protect".
- A file that is set to "Protect" can be changed to "Sharing" or "Confidential". However, a "Protect" file that is saved in the Quick File folder can only be changed to "Sharing".
- A file that is saved in the Quick File folder cannot be changed to "Confidential". If the file is moved to the Main folder or a custom folder, the property can be changed to "Confidential".
- Two properties cannot be selected for a single file.



# MOVING A STORED FILE

Use this procedure to change the location of a file (move a file to a different folder).  
After selecting the desired file, follow the steps below.

 [SELECTING A FILE](#) (page 6-30)

1

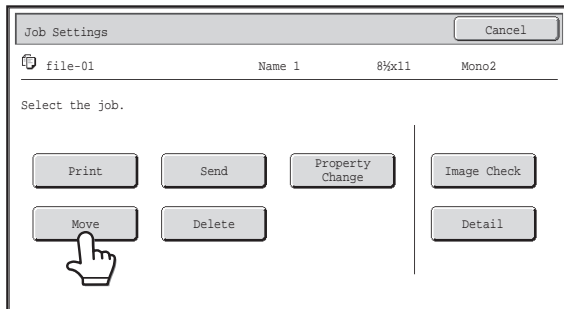

Touch the [Move] key.

2

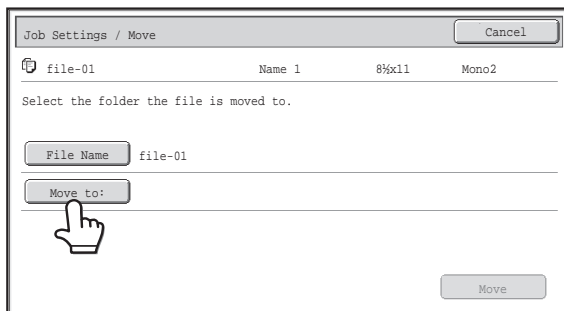

Touch the [Move to:] key.



- A file cannot be moved to the Quick File Folder. With this procedure, the original name is changed and the file is moved to the specified folder. (Unlike the "Save As" command on a computer, the file is not copied to the specified folder with the original file remaining in the original location.)
- To change the file name, touch the [File Name] key.

3

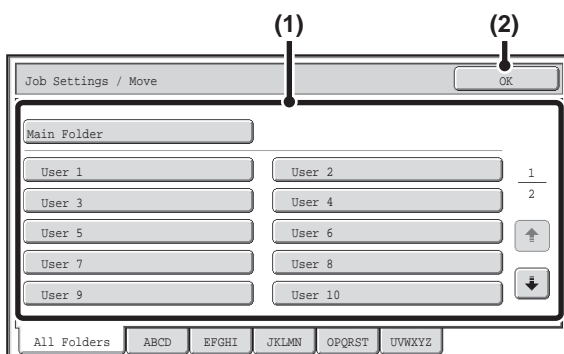

Select the destination folder.

(1) Touch the key of the folder to which you want to move the file.

If a password is set for the selected folder, a password entry screen will appear.

Enter the password with the numeric keys (5 to 8 digits) and touch the [OK] key.

(2) Touch the [OK] key.

The above screen shows the custom folders as an example.

4

file-01	Name 1	8%x11	Mono2
Select the folder the file is moved to.			
File Name	file-01		
Move to:	User 2		

Touch the [Move] key.



A file whose property is "Protect" cannot be moved. To move a protected file, change its property to "Sharing" or "Confidential".

# DELETING A STORED FILE

Stored files that are no longer needed can be deleted.  
Select the file that you wish to delete and touch the [Delete] key.  
🔗 [SELECTING A FILE](#) (page 6-30)

1

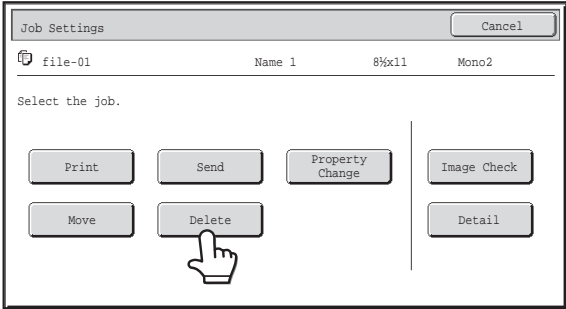

Touch the [Delete] key.

2

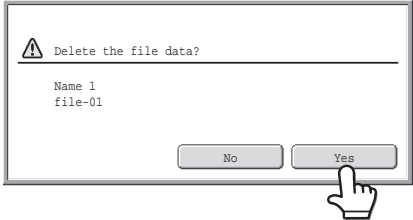

Check the file and then touch the [Yes] key.

 A file whose property is "Protect" cannot be deleted. To delete a protected file, change its property to "Sharing" or "Confidential".

# CHECKING AN IMAGE OF A STORED FILE

You can check an image of a file stored using document filing.  
Select the desired file and touch the [Image Check] key.

 [SELECTING A FILE](#) (page 6-30)

1

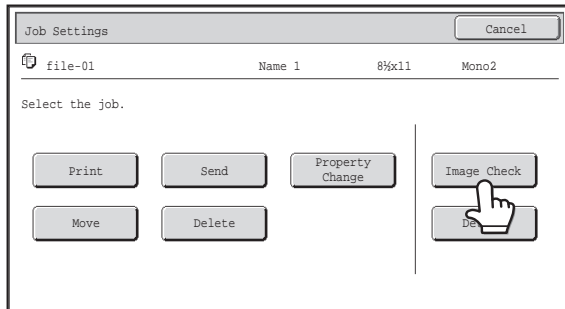

Touch the [Image Check] key.

2

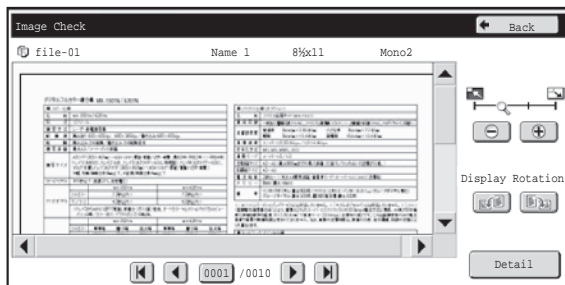

Check the image of the file.

For information on each of the items, see "[IMAGE CHECK SCREEN](#)" (page 6-46).

# IMAGE CHECK SCREEN

This section explains the image check screen.

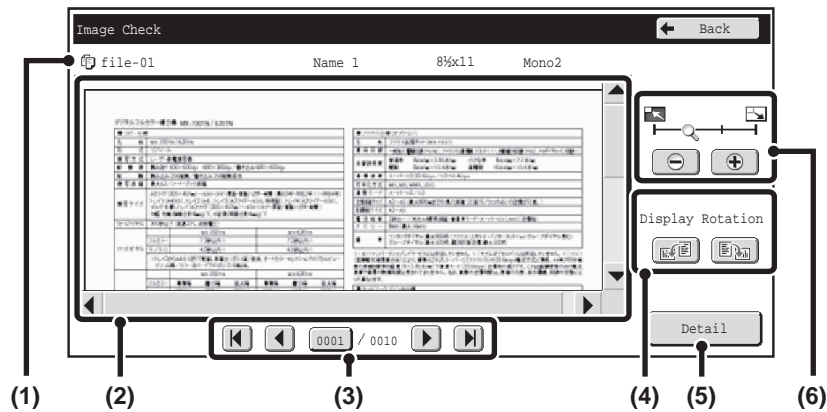

## (1) Information display

This shows information on the displayed image.

## (2) Preview image

This shows an image of the selected file.

If the image is cut off, use the scroll bars at the right and bottom of the screen to scroll the image. Touch a bar and slide it to scroll. (You can also touch the keys to scroll.)

## (3) Change page keys

When there are multiple pages, use these keys to change pages.

- keys: Go to the first or the last page.
- keys: Go to the previous page or the next page.
- Page number display: This shows the total number of pages and the current page number. You can touch the current page number key and enter a number with the numeric keys to go to that page number.

## (4) "Display Rotation" key

This rotates the image right or left by 90 degrees. The rotation applies to all pages in the file, not just the displayed page.



A print file cannot be rotated.

## (5) [Detail] key

This shows the detailed information screen.

[FILE SELECTION SCREEN](#) (page 6-28)

## (6) Display zoom key

Use this to set the zoom ratio of the displayed image. The setting applies to all pages in the file, not just the displayed page.



For a print file, only an image of the first page of the file is shown; the displayed page cannot be changed.



A preview image is an image for display on the touch panel. It will differ from the actual print result.

# RETRIEVING AND USING A FILE FROM THE JOB STATUS SCREEN

Files stored using File and Quick File appear as keys in the job status complete screen.

This is convenient when you need to quickly print the saved data of a copy job or quickly send a saved fax to another destination.

1

JOB STATUS



Press the [JOB STATUS] key.

2

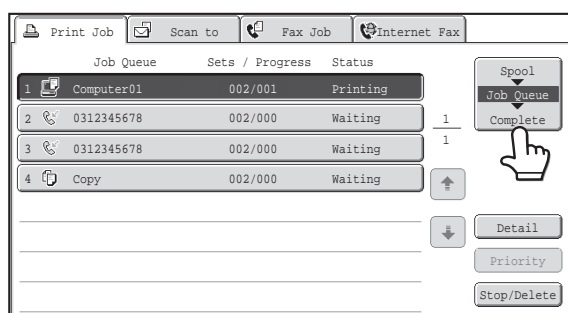

Touch the job status selector key so that [Complete] is highlighted.

3

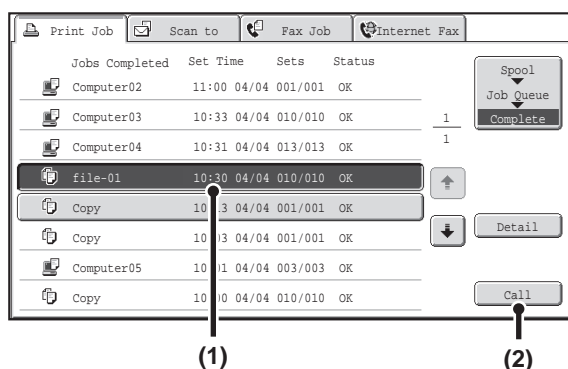

(1)

(2)

Select the desired file in the completed jobs.

- (1) Touch the key of the desired file.
- (2) Touch the [Call] key.

The job settings screen appears.

Select and perform the desired operation.

- ☞ [JOB SETTINGS SCREEN](#) (page 6-31)
- ☞ [PRINTING A STORED FILE](#) (page 6-32)
- ☞ [SENDING A STORED FILE](#) (page 6-38)
- ☞ [PROPERTIES OF STORED FILES](#) (page 6-40)
- ☞ [MOVING A STORED FILE](#) (page 6-42)
- ☞ [DELETING A STORED FILE](#) (page 6-44)
- ☞ [CHECKING AN IMAGE OF A STORED FILE](#) (page 6-45)



To view information on a file, select the file and then touch the [Detail] key.

# SEARCHING FOR A STORED FILE

When there are many stored files, it may take time to find a file. The search function of document filing mode can be used to find a file quickly.

This section explains how to search for a file or folder on the machine's hard drive.

Searching is possible even when you only know part of the file name or folder name. A folder can also be specified as a search range.

**Example: Only part of a file name is known: "Meeting"**

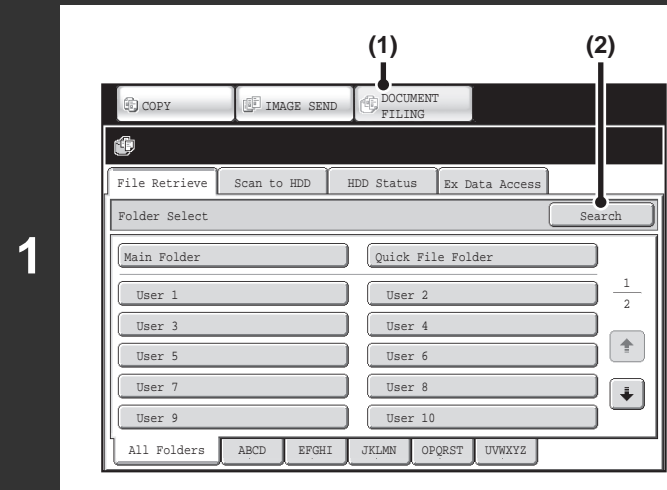
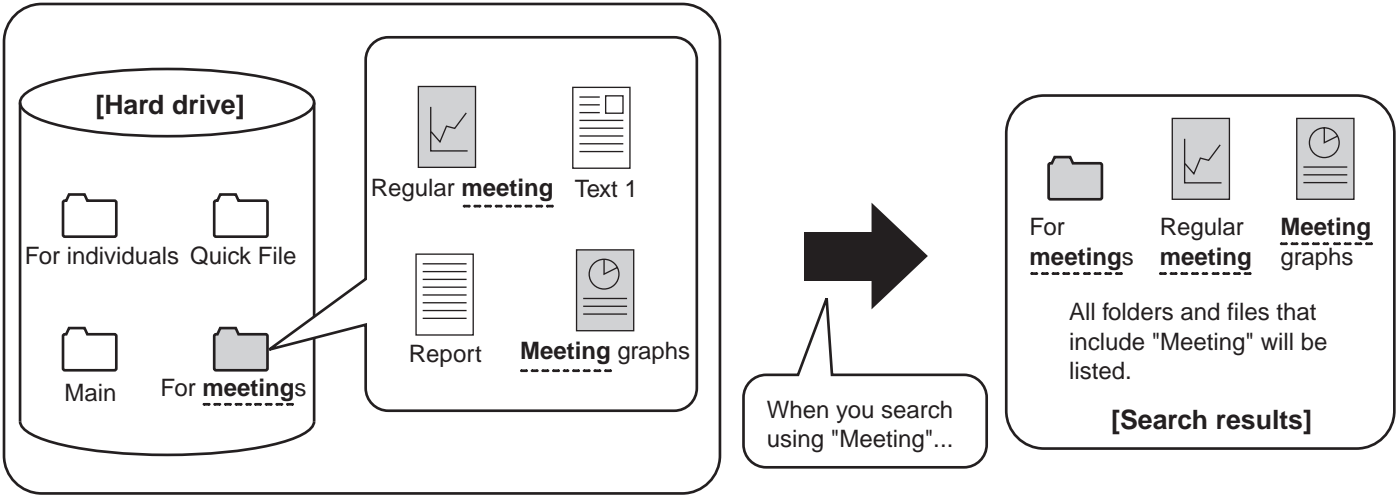

**Open the file search screen.**

- (1) Touch the [DOCUMENT FILING] key.
- (2) Touch the [Search] key.

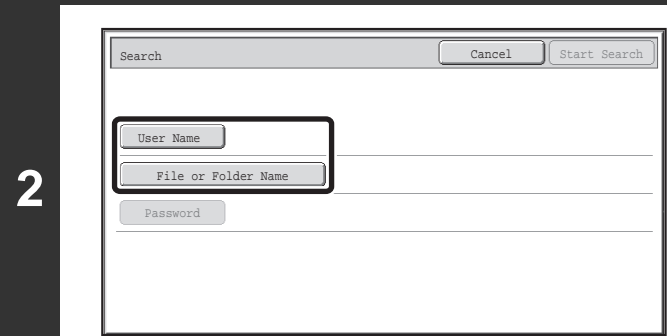

**Touch the [User Name] key or the [File or Folder Name] key.**

If you know the user name, touch the [User Name] key and go to "Using the user name to search" in step 3.

If you know the file name, touch the [File or Folder Name] key and go to "Using the file name or folder name to search" in step 3.

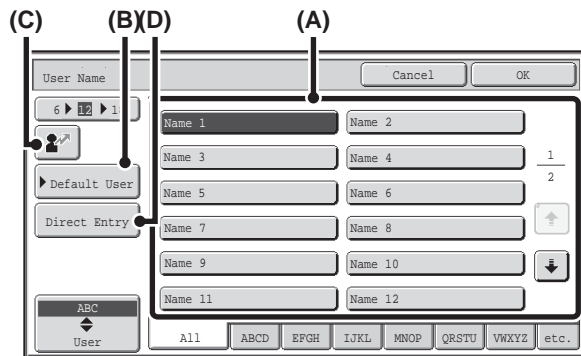

## Using the user name to search

There are four ways to select the user name:

### (A) Touch the key of the user name.

The touched user name is highlighted.

If you accidentally select the wrong user name, touch the key of the correct name.

### (B) Touch the [Default User] key.

The user name can be selected from the factory stored users.

### (C) Touch the key.

An area for entering the "Registration No." [---] appears in the message display. Enter the "Registration No." set during user registration. This will allow you to select the user name.

### (D) Touch the [Direct Entry] key.

A text entry screen appears. Directly enter the user name. Searching is possible even if you only enter the first several letters of the user name.

After selecting the user name, touch the [OK] key.

After the user name is selected, the [Password] key can be touched. To search for files of the selected user name that have a certain password, touch the [Password] key and enter the password.

(It is not possible to search using a password only.)

## Using the file name or folder name to search

Enter the file name or folder name in the text entry screen that appears and touch the [OK] key.



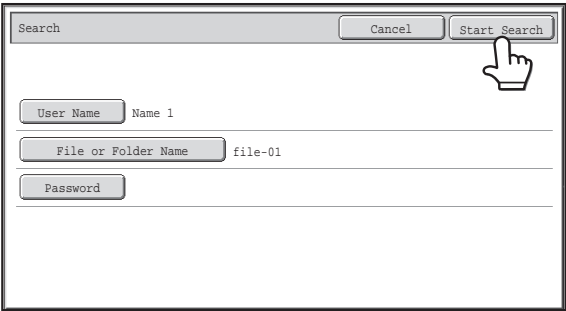

**Touch the [Start Search] key.**

The search results will appear in a screen similar to the following screen. A list of the files that match your search criteria will appear. Select the desired file from the list. The job settings screen will appear.



To return to the base screen of document filing mode, touch the [Cancel] key.  
To return to the file search screen, touch the [Search Again] key.



- When you search using [File or Folder Name], custom folders that match the search characters will also appear in the list. When a folder key is touched, a list of the files in the folder appears. Touch the desired file in the list.
- You can also use the Web pages to search for a file. Click [Document Operations], [Document Filing], and then [Search] in the Web page menu.

## Searching within a folder

You can specify a folder to restrict the search range to that folder. To search within a specified folder, follow the steps below.

1

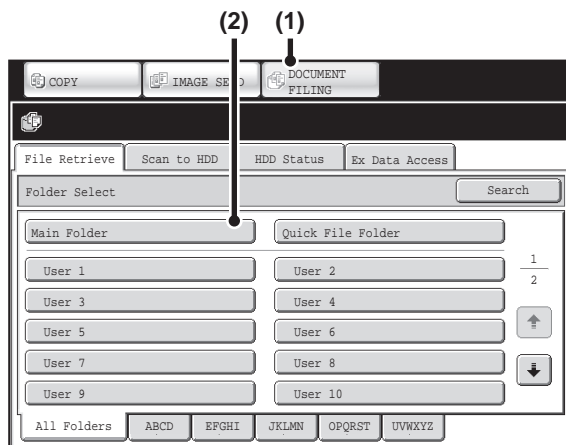

Open the folder that you wish to search.

(1) Touch the [DOCUMENT FILING] key.

(2) Touch the key of the folder that you wish to search.

If a password is set for the selected folder, a password entry screen will appear.

Enter the password with the numeric keys (5 to 8 digits) and touch the [OK] key.

2

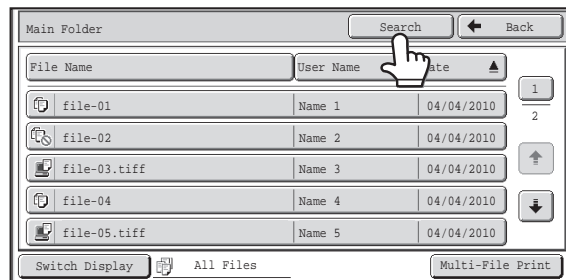

Touch the [Search] key.

3



Touch the [User Name] key or the [File or Folder Name] key.

If you know the user name, touch the [User Name] key and go to "[Using the user name to search](#)" in step 4.

If you know the file name, touch the [File or Folder Name] key and go to "[Using the file name or folder name to search](#)" in step 4.

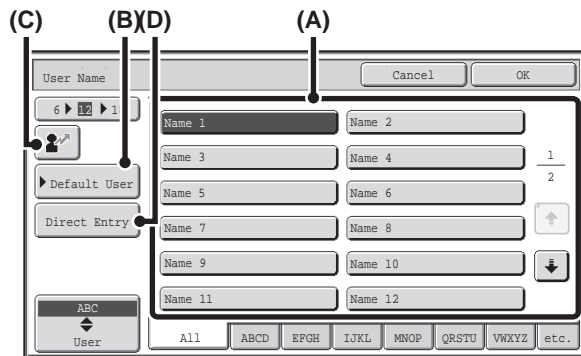

## Using the user name to search

There are four ways to select the user name:

### (A) Touch the key of the user name.

The touched user name is highlighted.

If you accidentally select the wrong user name, touch the key of the correct name.

### (B) Touch the [Default User] key.

The user name can be selected from the factory stored users.

### (C) Touch the key.

An area for entering the "Registration No." [---] appears in the message display. Enter the "Registration No." set during user registration. This will allow you to select the user name.

### (D) Touch the [Direct Entry] key.

A text entry screen appears. Directly enter the user name. Searching is possible even if you only enter the first several letters of the user name.

After selecting the user name, touch the [OK] key.

After the user name is selected, the [Password] key can be touched. To search for files of the selected user name that have a certain password, touch the [Password] key and enter the password.

(It is not possible to search using a password only.)

## Using the file name or folder name to search

Enter the file name in the text entry screen that appears and touch the [OK] key.

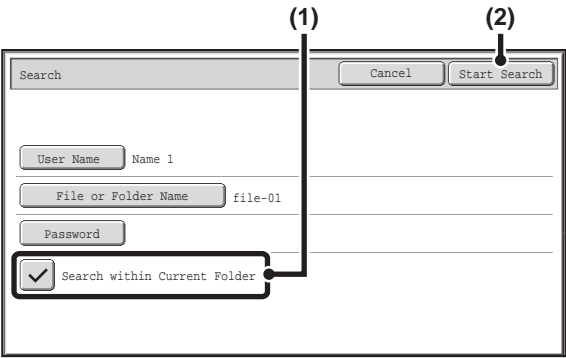

**Start searching.**

- (1) **Touch the [Search within Current Folder] checkbox so that it is selected .**  
 To search only files that are in the current folder, select the [Search within Current Folder] checkbox . Use this method to search for a file in a confidential folder.
- (2) **Touch the [Start Search] key.**  
 The search results will appear in a screen similar to the following screen. A list of the files that match your search criteria will appear. Select the desired file from the list. The job settings screen will appear.



To return to the base screen of document filing mode, touch the [Cancel] key.  
 To return to the file search screen, touch the [Search Again] key.

# CHAPTER 7

# SYSTEM SETTINGS

This chapter explains the system settings, which are used to configure a variety of parameters to suit the aims and needs of your workplace. The current selections that have been made for the settings can be viewed or printed out. To quickly check where a setting is located in the system settings menu, see "System Settings Menu" (page 7-114), "Accessing the System Settings (General)" (page 7-5), or "Accessing the System Settings (Administrator)" (page 7-32). For the system settings for the fax function, see "System Settings for Fax (General) List" (page 7-101) and "System Settings for Fax (Administrator) List" (page 7-107).

## SYSTEM SETTINGS

<b>System Settings</b> .....	<b>7-3</b>
<b>Common Operation Methods</b> .....	<b>7-4</b>

## SYSTEM SETTINGS (GENERAL)

<b>Accessing the System Settings (General)</b> .....	<b>7-5</b>
<b>System Settings (General) List</b> .....	<b>7-6</b>
<b>Total Count</b> .....	<b>7-10</b>
• Job Count .....	7-10
• Device Count .....	7-10
<b>Default Settings</b> .....	<b>7-11</b>
• Clock Adjust .....	7-11
• Keyboard Select .....	7-12
<b>List Print (User)</b> .....	<b>7-13</b>
<b>Paper Tray Settings</b> .....	<b>7-14</b>
• Tray Settings .....	7-14
• Paper Type Registration .....	7-16
• Auto Tray Switching .....	7-16
• Custom Size Registration (Bypass) .....	7-16
<b>Address Control</b> .....	<b>7-17</b>
• Address Book .....	7-17
• Custom Index .....	7-22
• Program .....	7-23
<b>Fax Data Receive/Forward</b> .....	<b>7-25</b>
• I-Fax Settings .....	7-25
<b>Printer Condition Settings</b> .....	<b>7-26</b>
• Printer Default Settings .....	7-26
• PCL Settings .....	7-27
• PostScript Setting .....	7-28
<b>Document Filing Control</b> .....	<b>7-29</b>
<b>USB-Device Check</b> .....	<b>7-30</b>
<b>User Control</b> .....	<b>7-31</b>
• Modify User Information .....	7-31

## SYSTEM SETTINGS (ADMINISTRATOR)

<b>Accessing the System Settings (Administrator)</b> .....	<b>7-32</b>
• When User Authentication is not Enabled .....	7-32
• When User Authentication is Enabled .....	7-33
<b>System Settings (Administrator) List</b> .....	<b>7-35</b>
<b>User Control</b> .....	<b>7-51</b>
• User Authentication Setting .....	7-51
• Other Settings .....	7-52
• User List .....	7-53
• Page Limit Group List .....	7-55
• Authority Group List .....	7-56
• Favorite Operation Group List .....	7-59
• User Count .....	7-61
• Card Settings .....	7-62
<b>Energy Save</b> .....	<b>7-63</b>
<b>Operation Settings</b> .....	<b>7-64</b>
• Other Settings .....	7-64
• MFP Display Pattern Setting .....	7-65
• Customize Key Setting .....	7-65
• Home Screen Settings .....	7-66
• My Menu Settings .....	7-66
• Preview Setting .....	7-67
• Remote Operation Settings .....	7-68
<b>Device Control</b> .....	<b>7-69</b>
• Other Settings .....	7-69
• Disabling of Devices .....	7-71
• Fusing Control Settings .....	7-71
<b>Copy Function Settings</b> .....	<b>7-72</b>
• Initial Status Settings .....	7-72
• Other Settings .....	7-73



<b>Network Settings</b> .....	<b>7-75</b>
<b>Printer Settings</b> .....	<b>7-76</b>
• Default Settings .....	7-76
• Interface Settings .....	7-77
<b>Image Send Settings</b> .....	<b>7-78</b>
• Operation Settings .....	7-78
• Scan Settings .....	7-82
• I-Fax Settings .....	7-84
<b>Document Filing Settings</b> .....	<b>7-88</b>
• Other Settings .....	7-88
• Document Output Options .....	7-90
• Automatic Deletion of File Settings .....	7-90
<b>List Print (Administrator)</b> .....	<b>7-91</b>
<b>Security Settings</b> .....	<b>7-92</b>
<b>Enable/Disable Settings</b> .....	<b>7-93</b>
<b>Change Administrator Password</b> .....	<b>7-96</b>
<b>Product Key</b> .....	<b>7-97</b>
<b>Data Backup</b> .....	<b>7-98</b>
<b>Storing/Calling of System Settings</b> .....	<b>7-99</b>
<b>Sharp OSA Settings</b> .....	<b>7-100</b>

## SYSTEM SETTINGS FOR FAX

<b>System Settings for Fax (General) List</b> .....	<b>7-101</b>
<b>Address Control</b> .....	<b>7-102</b>
• Address Book .....	7-102
• F-Code Memory Box .....	7-104
<b>Fax Data Receive/Forward</b> .....	<b>7-106</b>
• Fax Settings .....	7-106
<b>System Settings for Fax (Administrator) List</b> ..	<b>7-107</b>
<b>Image Send Settings</b> .....	<b>7-109</b>
• Fax Settings .....	7-109
<b>APPENDIX</b> .....	<b>7-114</b>
• System Settings Menu .....	7-114

# SYSTEM SETTINGS

## System Settings

The system settings are used to configure a variety of parameters to suit the aims and needs of your workplace. The system settings are also used to display or print out the current settings and status of the machine. The system settings allow you to make the machine easier to use.

The system settings consist of settings that are used by general users, and settings that can only be configured by an administrator of the machine. These two groups of settings are distinguished in this manual as follows.

System Settings (General)	System Settings (Administrator) *Login Required
<p>System settings that can be configured by general users (including the administrator). For example, the following settings can be configured:</p> <ul style="list-style-type: none"> <li>• Date and time settings</li> <li>• Paper tray settings (paper size and paper type)</li> <li>• Storing destinations for the fax and scanner functions</li> <li>• Settings related to the printer function</li> <li>• Creating folders for document filing</li> <li>• Displaying the number of pages printed, scanned, and faxed.</li> </ul> <p>For more information, see "<a href="#">SYSTEM SETTINGS (GENERAL)</a>" (page 7-5).</p>	<p>System settings that can be configured by the administrator. To configure these settings, login as an administrator is required. For example, the following settings can be configured:</p> <ul style="list-style-type: none"> <li>• Storing users of the machine</li> <li>• Energy save settings</li> <li>• Settings related to the operation panel</li> <li>• Settings for peripheral devices installed on the machine.</li> <li>• Settings related to the copy function</li> <li>• Network connection settings</li> <li>• Transmission/reception settings for faxes and scanned images</li> <li>• Advanced settings for the document filing function</li> </ul> <p>For more information, see "<a href="#">SYSTEM SETTINGS (ADMINISTRATOR)</a>" (page 7-32).</p>
<b>Settings for general users</b>	<b>Settings for administrators</b>



### • Administrator password

To maintain security, the administrator of the machine should promptly change the password after the machine is purchased. (For the factory default administrator password, see "TO THE ADMINISTRATOR OF THE MACHINE" in the Start Guide.) To change the password, see "[Change Administrator Password](#)" (page 7-96).

\*To ensure a high level of security, change the password at regular intervals.

- The above groupings of "General" and "Administrator" are used as a convenient means of clarifying the functions of the settings. These groupings do not appear in the touch panel.
- For fax settings, see "[SYSTEM SETTINGS FOR FAX](#)" (page 7-101).

### • Web pages

The system settings can also be configured from the Web pages. To configure the system settings from the Web pages, click [System Settings] in the Web page menu.

In addition to the system settings, network and security settings can also be configured in the Web pages. For information on the settings, see Help in the Web pages.

# Common Operation Methods

This section explains special operation methods that are common to all system settings.

Be sure to read this section, as the information is omitted in the explanations of some of the individual settings.

## Example: Address book screen

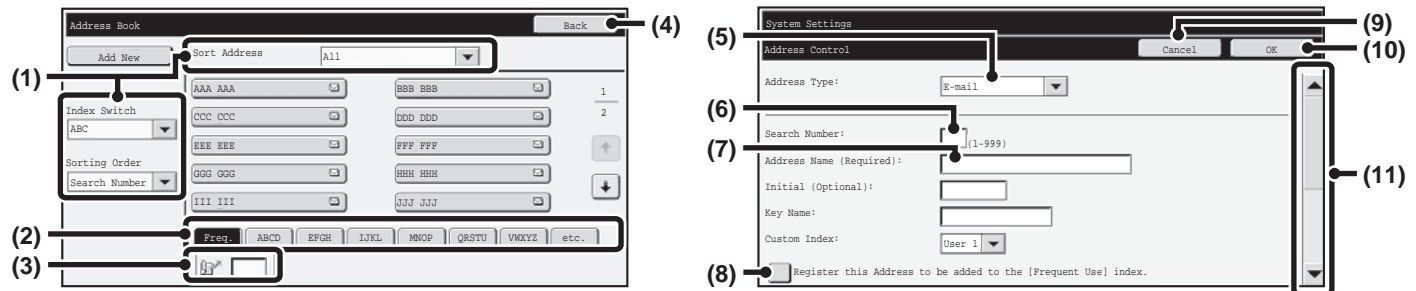

### (1) "Sort"

Use this to select the method of displaying destinations and the index type.

Example: In the "Address Book" screen, the display can be switched between the following three methods:

- Alphabetical/User index
- Display by mode
- Ascending/Descending/Number order

### (2) Index keys

Touch an index key to display the corresponding destinations. The index keys that appear vary depending on the "Sort" setting.

### (3) (Search number entry box)

To search for an address, touch  and enter a search number.

When a user is searched for, the icon changes to .

### (4) [Back] key

Returns you to the previous screen.

### (5) Select box

Touch  to display a list of the items that can be selected. Touch an item in the list to select it.

### (6) Text box (numerical)

Touch this box to enter a number. Numbers are entered with the numeric keys.

If you make a mistake, press the [CLEAR] key () to clear the incorrect number.

### (7) Text box

Touch this box to open a text entry screen. When you have finished entering text in the screen, the text will appear in the text box.

### (8) Checkbox

This switches between  and  each time you touch it. To enable the corresponding setting, touch the checkbox so that a checkmark appears . To disable the setting, clear the checkmark .

Radio buttons () are also used to select settings in this way. (However, radio buttons are used to select a single item out of several.)

### (9) [Cancel] key



This cancels a setting and returns you to the previous screen.

### (10) [OK] key

Touch this to store the current settings.

### (11) Scroll bar

Use this to scroll the screen up and down.

Touch the bar and slide it up or down to move the screen. You can also move the screen up and down with the   keys.



# SYSTEM SETTINGS (GENERAL)

This section describes the system settings that can be configured by general users of the machine.

## Accessing the System Settings (General)

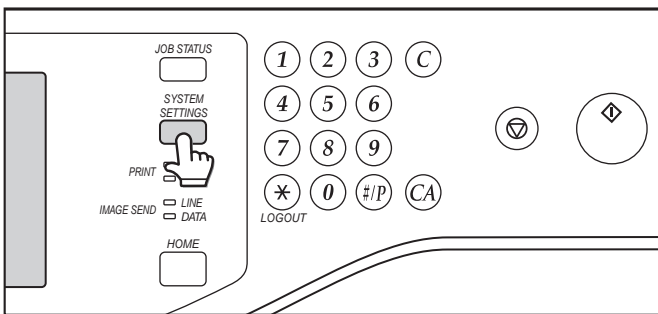

Make sure that the machine is in the standby state and then press the [SYSTEM SETTINGS] key on the operation panel.

When the [SYSTEM SETTINGS] key is pressed, the following menu screen appears on the touch panel.

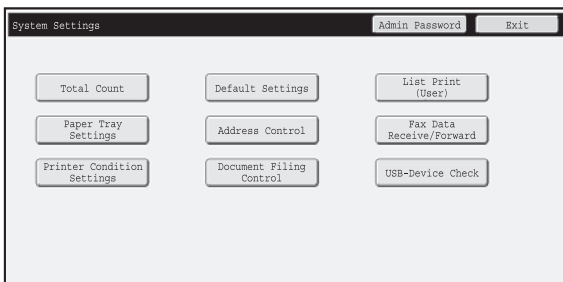

Touch the item in this screen that you wish to configure. For detailed explanations of each of the settings, see the following pages of this chapter.



- To quit the system settings, touch the [Exit] key in the top right corner of the screen.
- For the procedure to follow when user authentication is enabled, see "[USER AUTHENTICATION](#)" (page 1-17) in "1. BEFORE USING THE MACHINE".

# System Settings (General) List

When the system settings are accessed with general rights, the following items appear. For items that can only be accessed with administrator rights, see "[System Settings \(Administrator\) List](#)" (page 7-35).



- Depending on the machine specifications and peripheral devices installed, it may not be possible to use some settings.
- For explanations of settings related to the fax function, see "[SYSTEM SETTINGS FOR FAX](#)" (page 7-101).

## Total Count

Item	Factory default setting	Page
■ <b>Total Count</b>		7-10
● Job Count	–	7-10
● Device Count	–	7-10

## Default Settings

Item	Factory default setting	Page
■ <b>Default Settings</b>		7-11
● Clock Adjust		7-11
▶ Clock Adjust		
◆ Specify Time Zone	–	
◆ Date & Time Settings	–	
◆ Synchronize with Internet Time Server	Disable	
▶ Daylight Saving Time Setting	Disable	
▶ Date Format	[MM/DD/YYYY], [/], [Last], [12-Hour]	
● Keyboard Select	English (US)	7-12

## List Print (User)

Item	Factory default setting	Page
■ <b>List Print (User)</b>		7-13
● All Custom Setting List	–	
● Printer Test Page	–	
● Sending Address List	–	
● Document Filing Folder List	–	

## Paper Tray Settings

Item	Factory default setting	Page
■ Paper Tray Settings		7-14
● Tray Settings		7-14
▶ Tray 1	Plain, Auto-Inch	
▶ Tray 2*		
▶ Tray 3*		
▶ Tray 4*		
▶ Bypass	Plain, Auto-Inch	
◆ Select Similar Sizes for Auto Detection	8-1/2" x 14"	
● Paper Type Registration	–	7-16
● Auto Tray Switching	Enabled	7-16
● Custom Size Registration (Bypass)	Custom 1: X=11", Y=8-1/2" Custom 2: X=11", Y=8-1/2" Custom 3: X=11", Y=8-1/2"	7-16

\* When a 500-sheet paper feed unit is installed.

## Address Control

Item	Factory default setting	Page
■ Address Control		7-17
● Address Book	–	7-17
● Custom Index	User 1	7-22
● Program	–	7-23

## Fax Data Receive/Forward

Item	Factory default setting	Page
■ Fax Data Receive/Forward		7-25
● I-Fax Settings*		7-25
▶ Reception Start	–	
▶ Manual Reception Key in Initial Screen	Enabled	
▶ Forward Received Data	–	

\* When the Internet fax expansion kit is installed.

## Printer Condition Settings

Item	Factory default setting	Page
■ <b>Printer Condition Settings</b>		7-26
● <b>Printer Default Settings</b>		7-26
▶ Copies	1	
▶ Orientation	Portrait	
▶ Default Paper Size	8-1/2" x 11"	
▶ Default Paper Type	Plain Paper	
▶ Initial Resolution Setting	600dpi (High Quality)	
▶ Disable Blank Page Print	Disabled	
▶ Line Thickness	5	
▶ 2-Sided Print	1-Sided	
▶ N-Up Print	1-Up	
▶ Fit To Page	Enabled	
▶ Output		
◆ Print per Unit	Enabled	
◆ Staple*	Disabled	
▶ Quick File	Disabled	
● <b>PCL Settings</b>		7-27
▶ PCL Symbol Set Setting	PC-8	
▶ PCL Font Setting	Internal Font, 0: Courier	
▶ PCL Line Feed Code	0.CR=CR; LF=LF; FF=FF	
▶ Wide A4	Disabled	
● <b>PostScript Setting</b>		7-28
▶ Print PS Errors	Disabled	
▶ Binary Processing	Disabled	

\* When a finisher is installed.

**Document Filing Control**

Item	Factory default setting	Page
■ Document Filing Control		7-29

**USB-Device Check**

Item	Factory default setting	Page
■ USB-Device Check	-	7-30

**User Control**

Item	Factory default setting	Page
■ User Control*		7-31
● Modify User Information	-	7-31

\* When user authentication is enabled and the logged-in user does not have the authority to configure the system settings (administrator) (excluding factory default users).

---

---

## Total Count

This function shows the page count in each mode. Touch the [Total Count] key.

## Job Count

This displays or prints out the counts of all jobs.



- Each sheet of paper used for automatic two-sided copying is counted as two pages.
- Pages printed directly from the machine such as list prints are included in the "Other Prints" count.
- The items displayed (or printed) will vary depending on the machine specifications and peripheral devices installed.

## Device Count

This is used to display or print the counts of the peripheral devices installed on the machine.



- **Document feeder**  
Each sheet is counted as two pages when two-sided scanning is performed.
- The items displayed (or printed) will vary depending on the machine specifications and peripheral devices installed.

# Default Settings

The default settings for operation of the machine can be configured. Touch the [Default Settings] key and select the settings.

## Clock Adjust

Use this to set the date and time in the machine's built-in clock.

Set the time.

Item	Settings
Specify Time Zone	If your region is ahead of GMT (Greenwich Mean Time), select [+]. If your region is behind GMT, select [-]. Next, specify the time difference between your region and GMT in hours and minutes.
Date&Time Settings	Select and set the year, month, day, hour, and minute.
Synchronize with Internet Time Server	This can be used when the machine is connected to the Internet. The machine's time is automatically adjusted to the time of an Internet time server.

## Daylight Saving Time Setting

Enable daylight saving time.

Item	Settings
Daylight Saving Time Setting	Select whether or not the Daylight Saving Time Setting is enabled. If disabled, the following settings will not be possible.
Select Setting Type	Specify whether the starting and ending day of daylight saving time are to be set using the day of the week or the date.
Start Time	Set the starting time of daylight saving time. Set the starting month. If you selected "Day of the Week" in "Select Setting Type", set the starting week of daylight saving time and then the starting day. If you selected "Date" in "Select Setting Type", set the starting date. Set the hour and minute and the UTC (Coordinated Universal Time) setting.
Completing Time	Set the ending time of daylight saving time in the same way as you set the starting time.
Adjustment Time	Set the time that adjustment will take place when daylight saving time begins.

## Date Format

The format used to print the date on lists and other output can be changed.

Item	Settings
Current Setting	The current time appears in the format set in the date format settings.
Format	Set the order of display of the year, month, and day (YYYY/MM/DD).
Separator	Select one of three symbols or a blank space for the separator used in the date.
Day-Name Position	Select whether the day name appears before or after the date.
Time Display	Select 12-hour format or 24-hour format for the time. 12-Hour Display: 12:00AM to 11:59AM/12:00 to 11:59PM 24-Hour Display: 00:00 to 23:59



If "[Disabling of Clock Adjustment](#)" (page 7-64) has been enabled in the system settings (administrator), the date and time cannot be set.

# Keyboard Select

The layout of the keyboard that appears in text entry screens can be changed.  
The keyboard layouts that can be selected are shown below.

English (US)	English (UK)	Japanese	French	German	Swedish
Norwegian	Finnish	Danish	Russian	Greek	Turkish



# List Print (User)

Lists showing the settings and information stored in the machine can be printed. Touch the [List Print (User)] key and select the settings.

List name	Description
All Custom Setting List	This list shows the hardware status, software status, printer condition settings, paper tray settings, and total counts.
Printer Test Page	This is used to print the PCL Symbol Set List, various font lists, and the NIC page (network interface settings, etc.). <ul style="list-style-type: none"> <li>• PCL Symbol Set List</li> <li>• PCL Internal Font List</li> <li>• PCL Extended Font List</li> <li>• PS Font List</li> <li>• PS Extended Font List</li> <li>• NIC Page</li> </ul>
Sending Address List	Lists can be printed of various addresses stored in the machine. <ul style="list-style-type: none"> <li>• Individual List</li> <li>• Group List</li> <li>• Program List</li> <li>• Memory Box List</li> <li>• All Sending Address List</li> </ul>
Document Filing Folder List	This shows the folder names for document filing.



- The items that appear will vary depending on the functions that have been added to the machine.
- If "[Prohibit Test Page Printing](#)" (page 7-76) has been enabled in the system settings (administrator), it will not be possible to print a test page.

# Paper Tray Settings

Paper tray and paper type settings are explained in this section. Touch the [Paper Tray Settings] key to configure the settings.

## Tray Settings

These settings specify the paper type, paper size, and functions allowed for each paper tray. When the [Tray Settings] key is touched, a list appears showing the trays and the current settings.

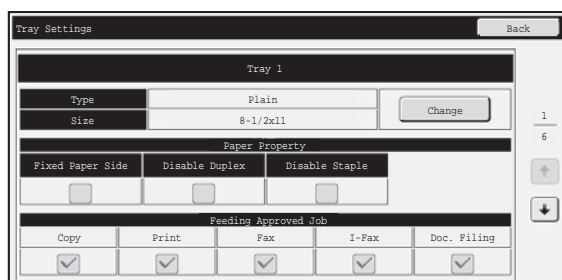

## Settings of each tray

Touch the [Change] key in the above screen to change the settings.

The following settings can be configured.

Item	Description
Type	Select the type of paper that is loaded in the tray. The paper types that can be selected vary by paper tray. For more information, see " <a href="#">Tray Settings</a> " (page 7-15). To store a new paper type, see " <a href="#">Paper Type Registration</a> " (page 7-16).
Size	Select the paper size from the list. The paper sizes that can be selected vary by tray. The sizes that can be selected may also be restricted by the paper type selected above. For more information, see " <a href="#">Tray Settings</a> " (page 7-15). If the desired size does not appear in the list, select [Custom Size] and directly enter the size (only for the bypass tray). For more information, see " <a href="#">Tray Settings</a> " (page 7-15).
Feeding Approved Job	Select the modes that can be used. If there is a function that you do not wish to be used with the selected tray, disable the function. When the "Type" is other than plain paper, recycled paper, colored paper, or a user type, [Fax] and [Internet Fax] cannot be selected.

-  If the paper size specified here is different from the size of paper that is loaded in a tray, a problem or misfeed may result when printing.  
To change the paper size in a tray, see "1. BEFORE USING THE MACHINE".
- Paper properties such as "Fixed Paper Side" are automatically set when the paper type is selected. The paper tray properties cannot be changed in this screen.
- If "[Disabling of Tray Settings](#)" (page 7-71) has been enabled in the system settings (administrator), the tray settings (except for the bypass tray) cannot be configured.

## Tray Settings

Paper Tray	Paper Type	Size
Tray 1	Plain, Pre-Printed, Recycled, Letter Head, Pre-Punched, Color, User Type	Auto-Inch (8-1/2" x 14", 8-1/2" x 11", 7-1/4" x 10-1/2", 5-1/2" x 8-1/2"), Auto-AB (A4, A5, B5, 216 mm x 330 mm (8-1/2" x 13")), 8-1/2" x 13-2/5" (216 mm x 340 mm), 216 mm x 343 mm (8-1/2" x 13-1/2"), 16K
Tray 2*1		
Tray 3*1		
Tray 4*1		
Bypass	In addition to the paper types of trays 1 to 4, Heavy Paper*2, Thin Paper	Auto-Inch (8-1/2" x 14"*3, 8-1/2" x 13-2/5" (216 mm x 340 mm)*3, 8-1/2" x 11", 7-1/4" x 10-1/2", 5-1/2" x 8-1/2"), Auto-AB (A4, A5, B5, 216 mm x 330 mm (8-1/2" x 13))*3, 216 mm x 340 mm (8-1/2" x 13-2/5)*3, 216 mm x 343 mm (8-1/2" x 13-1/2)*3), Size Input-Inch (X=5-1/2" to 14", Y=5-1/2" to 8-1/2"), Size Input-AB (X=140 mm to 356 mm, Y=100 mm to 216 mm), 16K, Custom 1, Custom 2, Custom 3
	Labels	Auto-Inch (8-1/2" x 11"), Auto-AB (A4, B5)
	Transparency	Auto-Inch (8-1/2" x 11"), Auto-AB (A4)
	Envelope	Com-10, Monarch, DL, C5

\*1 When a 500-sheet paper feed unit is installed.

\*2 Heavy Paper: 28 lbs to 56 lbs (106 g/m<sup>2</sup> to 209 g/m<sup>2</sup>) heavy paper

\*3 The size that is automatically detected is set in "[Select Similar Sizes for Auto Detection](#)" in the bypass tray settings screen (see below).

### Select Similar Sizes for Auto Detection

"Select Similar Sizes for Auto Detection" in the bypass tray settings screen is used to select the paper size that is automatically detected from similar sizes when automatic paper size detection takes place.

Select one of two sizes when "Auto-Inch" is set. Select one of three sizes when "Auto-AB" is set.

When paper that is the same size as one of the paper sizes in the settings is placed in the bypass tray, the size that is selected in the settings will be automatically detected.

Auto-Inch	8-1/2" x 14", 8-1/2" x 13-2/5" (216 mm x 340 mm)
Auto-AB	216 mm x 330 mm (8-1/2" x 13"), 216 mm x 340 mm (8-1/2" x 13-2/5"), 216 mm x 343 mm (8-1/2" x 13-1/2")

## Paper Type Registration

Store a paper type when the desired paper type does not appear as a selection or when you wish to create a new set of paper properties.

Up to 7 paper types can be stored.

Item	Description
Type Name	Store any name. The factory default names are "User Type 1" - "User Type 7".
Fixed Paper Side	Enable this setting when paper with a front and reverse side is used.
Disable Duplex	Enable this setting when paper is loaded that cannot be used for two-sided printing.
Disable Staple	Enable this setting when paper is used that cannot be stapled.



The settings that can be selected vary depending on the peripheral devices installed.

## Auto Tray Switching

When a tray runs out of paper during printing, this determines whether or not another tray with the same size and type of paper is automatically selected and printing continues.

## Custom Size Registration (Bypass)

If you frequently use a special non-standard paper size in the bypass tray, you can store that paper size.

Storing the paper size saves you the trouble of setting the size each time you need to use it.

Up to three paper sizes can be stored.

Touch the key ([Custom 1] to [Custom 3]) in which you wish to store or change a paper size. The following screen will appear:

Select whether you wish to enter the size in inches ("Size Input-Inch") or mm ("Size Input-AB"), and then set the X and Y dimensions of the paper.

### "Size Input-Inch"

The X dimension can be set to a value from 5-1/2" to 14". The factory default setting is 11".

The Y dimension can be set to a value from 5-1/2" to 8-1/2". The factory default setting is 8-1/2".

### "Size Input-AB"

The X dimension can be set to a value from 140 mm to 356 mm. The factory default setting is 297 mm.

The Y dimension can be set to a value from 100 mm to 216 mm. The factory default setting is 210 mm.

# Address Control

Address Control is used to store, edit, and delete one-touch keys, group keys, program keys, and custom indexes. Touch the [Address Control] key to configure the settings.



- The settings that can be selected vary depending on the peripheral devices installed.
- For explanations of settings related to the fax function, see "[SYSTEM SETTINGS FOR FAX](#)" (page 7-101).

## Address Book

Destinations can be stored in the address book for easy retrieval. When the [Address Book] key is touched, the following screen appears.

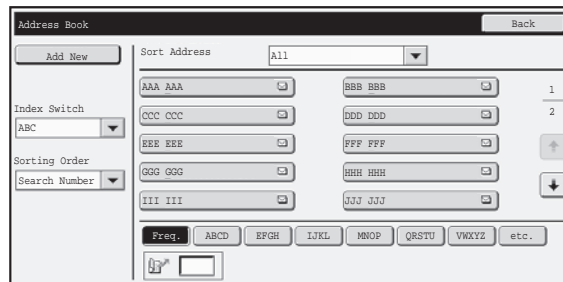

- **[Add New] key**

Use this to add a new address.

- **List display**

This displays a list of the currently stored addresses. An address can be selected to open an edit/delete screen for the address.

## Storing addresses

Touch the [Add New] key in the above screen to store an address. Up to 999 addresses can be programmed. For more information, see "[Settings](#)" (page 7-18).



- When "[Disable Registering Destination from Operation Panel](#)" (page 7-79) is enabled in the system settings (administrator) for a function, addresses cannot be stored for that function.
- **To store addresses for Scan to FTP, Scan to Network Folder, and Scan to Desktop...**  
Store Scan to FTP and Scan to Network addresses in the Web pages. Store Scan to Desktop addresses using Network Scanner Tool. A combined maximum of 200 addresses can be stored for these three scanning methods.

## Editing and deleting addresses

An address can be selected from the list in the above screen to open an edit/delete screen for the address. For more information, see "[Settings](#)" (page 7-18).

Delete an address with the [Delete] key.



- **If you cannot edit or delete a one-touch individual or group key...**

Individual keys and group keys cannot be edited or deleted in the following situations:

- The key is used in a reserved transmission or a transmission in progress.
- The key is included in a group key.
- The key is included in a program.
- The key is specified as a forwarding destination in the "[Default Address Setting](#)" (page 7-83) or "[Inbound Routing Settings](#)" / "[Document Administration Function](#)" (in the Web pages).
- When "[Disable Registering Destination from Operation Panel](#)" (page 7-79) is enabled.

If the key is used in a reserved transmission or a transmission that is in progress, cancel the transmission or wait until it is completed and then edit or delete the key.

If the key is included in a group, first delete the key from the group and then edit or delete the key.

If the key is specified as a forwarding destination, cancel the forwarding destination setting and then edit or delete the key. If "[Disable Registering Destination from Operation Panel](#)" has been enabled, clear this function and then edit or delete the key.

## Settings

Item	Description
<b>Items stored in all modes</b>	
Address Type	Select the type of address to be stored in the address book. <ul style="list-style-type: none"> <li>• E-mail: Store an e-mail address in a one-touch key.</li> <li>• Internet Fax: Store an Internet fax address in a one-touch key.</li> <li>• Direct SMTP: Store a Direct SMTP address in a one-touch key.</li> <li>• Fax: Store a fax number in a one-touch key.</li> <li>• Group: Store multiple addresses as a group for a broadcast transmission.</li> </ul>
Search Number	Set a search number. The lowest available number is automatically entered. To change the number, enter a number from 001 to 999. A search number that has already been stored cannot be used.
Address Name	Enter a maximum of 36 characters for the address name.
Initial	Enter up to 10 characters for the initials. The initials you enter here determine the position of the one-touch key in the alphabetical index.
Key Name	Enter the name that you wish to appear in the address book (this is different from the address name).
Custom Index	Select the custom index in which the address will appear.
Register this Address to be added to the [Frequent Use] index.	Frequently used addresses can be stored in the [Frequent Use] index.
<b>Items appearing when an e-mail address is stored</b>	
E-mail Address	Enter an e-mail address (max. 64 characters).
File Format	Specify the format of the file to be generated and the compression mode for black & white mode and color mode. <ul style="list-style-type: none"> <li>• File Type: Set the format of the file to be generated.</li> <li>• Compression Mode (Black &amp; White): Select the compression mode for black &amp; white transmission.</li> <li>• Compression Ratio (Color/Grayscale): Select the compression ratio for color/grayscale transmission.</li> </ul>

Item	Description
<b>Items appearing when an Internet fax address is stored</b>	
I-Fax Address	Enter an Internet fax address (max. 64 characters).
File Format	Compression Mode: Select the compression mode for transmission.
Request Internet Fax Reception Report	Select whether or not you wish to receive a reception report by e-mail after transmission is completed.
<b>Items appearing when a Direct SMTP address is stored</b>	
<ul style="list-style-type: none"> <li>• Direct SMTP Address</li> <li>• Add Hostname or IP Address.</li> <li>• Hostname or IP Address</li> </ul>	<p>Use these three settings to set an address for Direct SMTP transmission. In many cases, transmission is possible using method (1). A maximum of 64 characters each can be entered in the "Direct SMTP Address" and "Hostname or IP Address" text boxes.</p> <p><b>(1) Using the IPv4 address of the receiving machine in the domain part of the e-mail address</b>  Enter the e-mail address of the receiving machine in the [Direct SMTP Address] text box with the IPv4 address substituted for the domain.  Example: When the e-mail address of the receiving machine is "user@sample_domain.com" and the IPv4 address is "192.168.123.45" Enter "<b>user@192.168.123.45</b>" in the [Direct SMTP Address] text box.</p> <p><b>(2) Using the host name in the domain part of the e-mail address of the receiving machine</b>  Enter the e-mail address of the receiving machine in the [Direct SMTP Address] text box with the host name substituted for the domain.  Example: When the e-mail address of the receiving machine is "user@sample_domain.com" and the host name is "HOST" Enter "<b>user@HOST</b>" in the [Direct SMTP Address] text box.</p> <p><b>(3) When the receiving machine is set to only receive e-mail from specific addresses</b>  Enter the specified specific e-mail address in the [Direct SMTP Address] text box. Select the "Add Hostname or IP Address." checkbox and enter the host name or IPv4 address of the receiving machine in the [Hostname or IP Address] text box.  Example: When the e-mail address of the receiving machine is "user@sample_domain.com" and the IPv4 address is "192.168.123.45" Enter "<b>user@sample_domain.com</b>" in the [Direct SMTP Address] text box and enter "<b>192.168.123.45</b>" in the [Hostname or IP Address] text box.</p>
File Format	Compression Mode: Select the compression mode for transmission.
<b>Items appearing when a group is stored</b>	
Address	<ul style="list-style-type: none"> <li>• Address: Select addresses from the address book to be stored in the group.</li> <li>• Direct Entry: An address that is not stored in the address book can be directly entered. Enter the address in the same way as when storing an address for a mode. Note that when an Internet fax address is directly entered, the compression mode and reception report cannot be selected.</li> <li>• Address Review: This displays a list of the selected addresses. Addresses can be deleted from this list if needed.</li> </ul>

## Storing group keys

This section explains the procedure for storing group keys.

1

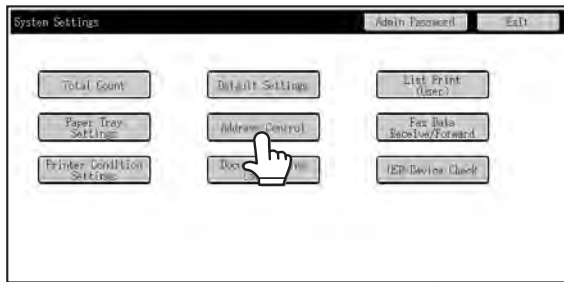

Touch the [Address Control] key.

2

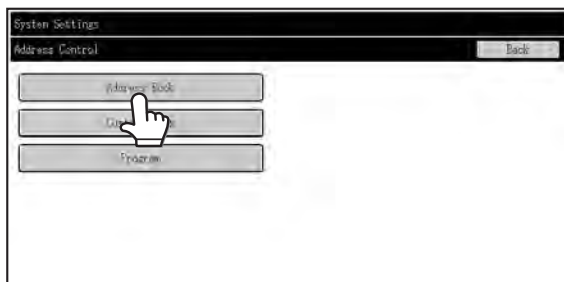

Touch the [Address Book] key.

3

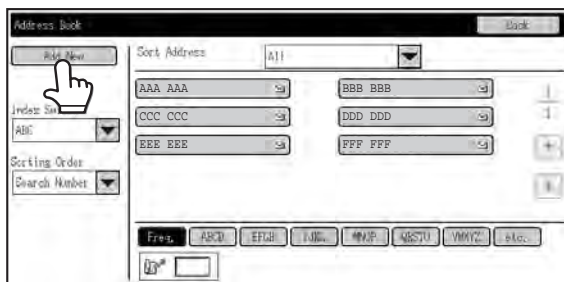

Touch the [Add New] key.

4

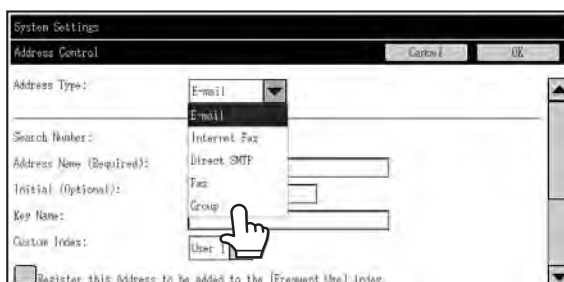

Select "Group" from the [Address Type] list.

5



Set the [Group Name], [Initial], and [Key Name] settings. (Other settings can be adjusted as necessary.)



6

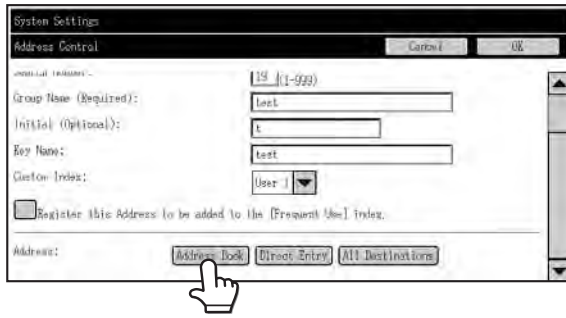

Use the scroll bar to display the lower part of the screen, and touch the [Address Book] key. (Touch the [Direct Entry] key to store an address that is not stored in a one-touch key.)

7

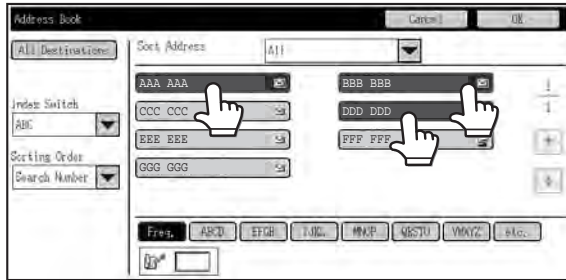

Touch the one-touch keys that you want to add to the group. (Three keys are added in this example.)

8

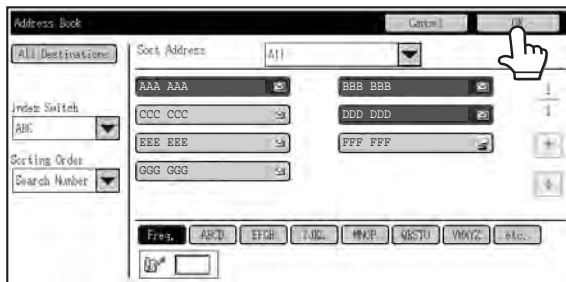

Touch the [OK] key.

9



Touch the [OK] key.

10



Touch the [OK] key on the dialog box that appears.

**11** The group key registration screen appears. If you want to finish, touch [Cancel] key to return to the previous screen.

The procedure is complete.

## Custom Index

The name of a custom index can be changed for greater ease of use.

Delete the previously entered name and enter a new name (maximum of 6 characters).

The factory default names for the custom indexes are "User 1" to "User 6".

# Program

If you frequently use the same settings and/or functions to transmit to the same destination or destinations, the settings and destinations can be stored in a program. This allows the settings and destinations to be selected by simply selecting the program.

When the [Program] key is touched, the following screen appears.

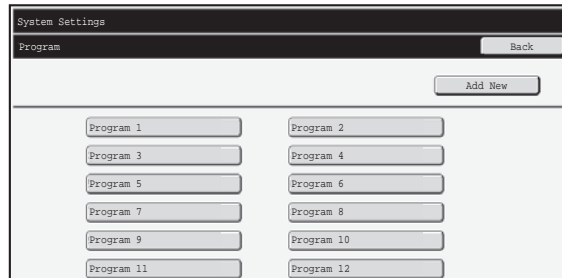

- **[Add New] key**

Use this to add a new program.

- **List display**

This displays a list of the currently stored programs. A program can be selected to open an edit/delete screen for the program.

## Storing a program

Touch the [Add New] key in the above screen to open a registration screen. Up to 48 programs can be stored. For more information, see "[Settings](#)" (page 7-24).



- A timer setting cannot be included in a program.
- At least one one-touch key must be specified in a program or the program cannot be stored.

## Editing and deleting programs

A program can be selected from the list in the above screen to open an edit/delete screen for the program. For more information, see "[Settings](#)" (page 7-24).

Delete a program with the [Delete] key.

## Settings

Item	Description
Program Number	Set the number to be assigned to the program. The lowest available number is automatically entered. To change the number, enter a number from 01 to 48. A number that has already been stored cannot be used.
Program Name	Enter a maximum of 36 characters for the program name.
Address	Select the address(es) to be used in the program from the address book. Up to 500 destinations can be stored in one program.
Address Book screen	This displays a list of the currently stored addresses.
Condition Settings	Touch the [Setup] key to open the condition settings screen for an address.
Address Mode Setting	Select the mode in which the address is used (Internet fax, scan, etc.) When a mode is selected, the settings for that mode appear.
Mode Settings	Frequently used settings can be stored in the same way as when they are selected for a mode.

# Fax Data Receive/Forward

This section explains settings for reception and forwarding. Touch the [Fax Data Receive/Forward] key and configure the settings.



For explanations of settings related to the fax function, see "[SYSTEM SETTINGS FOR FAX](#)" (page 7-101).

## I-Fax Settings

These settings can be configured when the Internet fax expansion kit is installed.

### Reception Start

Touch this key to immediately connect to your mail server (POP3 server) and check for received Internet faxes. If you have received Internet faxes, the faxes will be retrieved and printed.



To use this function, POP3 server settings must be configured. Configure these settings in the screen that appears when [Application Settings] - [Internet Fax Settings] is selected in the Web page menu.

### Manual Reception Key in Initial Screen

This displays the [I-Fax Manual Reception] key in the base screen of Internet fax mode.

### Forward Received Data

When the machine cannot print because it is out of paper or out of toner, received faxes can be forwarded to another Internet fax machine.



- To store a forwarding address, see "[Set Address for Data Forwarding](#)" (page 7-86) in the system settings (administrator).
- If forwarding was not successful because the transmission was canceled or a communication error occurred, the faxes that were to be forwarded will return to the print queue on the machine.
- If the initial pages of a fax were successfully printed, only those pages that were not printed will be forwarded.
- Forwarding is not possible if no faxes were received or a forwarding address is not programmed.
- If "[Hold Setting for Received Data Print](#)" (page 7-79) is enabled, you will be prompted to enter a password. Enter the correct password with the numeric keys.



#### To cancel forwarding...

Press the [JOB STATUS] key, and then cancel the forwarding job in the same way as a transmission job.

# Printer Condition Settings

The Printer Condition Settings are used to configure basic printer settings and settings for printing from a DOS application. To configure the settings, touch the [Printer Condition Settings] key.

## Printer Default Settings

The default settings are used to set advanced print conditions for printing in an environment where the print driver is not used (such as printing from MS-DOS or from a computer that does not have the provided print driver installed).



When printing using the printer driver, the printer driver settings take precedence over the printer condition settings.

## Settings

Item	Selections
Copies	1 - 999 sets
Orientation	<ul style="list-style-type: none"> <li>• Portrait</li> <li>• Landscape</li> </ul>
Default Paper Size	8-1/2" x 14", 8-1/2" x 13", 8-1/2" x 11", 7-1/4" x 10-1/2", 5-1/2" x 8-1/2", A4, B5, A5, 16k
Default Paper Type	Plain Paper, Letter Head, Pre-Printed, Pre-Punched, Recycle Paper, Color
Initial Resolution Setting	<ul style="list-style-type: none"> <li>• 600 dpi</li> <li>• 600 dpi (High Quality)</li> <li>• 1200 dpi</li> </ul>
Disable Blank Page Print	<ul style="list-style-type: none"> <li>• <input type="checkbox"/> (Disabled)</li> <li>• <input checked="" type="checkbox"/> (Enabled)</li> </ul>
Line Thickness* <sup>1</sup>	0-9
2-Sided Print	<ul style="list-style-type: none"> <li>• 1-Sided</li> <li>• 2-Sided (Book)</li> <li>• 2-Sided (Tablet)</li> </ul>
N-Up Print* <sup>2</sup>	<ul style="list-style-type: none"> <li>• 1-Up</li> <li>• 2-Up</li> <li>• 4-Up</li> </ul>
Fit To Page* <sup>3</sup>	<ul style="list-style-type: none"> <li>• <input checked="" type="checkbox"/> (Use Fit to Page)</li> <li>• <input type="checkbox"/> (Do not use Fit to Page)</li> </ul>

Item		Selections
Output	Print per Unit	<ul style="list-style-type: none"> <li><input checked="" type="checkbox"/> (Use Print per Unit)</li> <li><input type="checkbox"/> (Do not use Print per Unit)</li> </ul>
	Staple*4	<ul style="list-style-type: none"> <li><input checked="" type="checkbox"/> (Use Staple)</li> <li><input type="checkbox"/> (Do not use Staple)</li> </ul>
Quick File		<ul style="list-style-type: none"> <li><input type="checkbox"/> (Disabled)</li> <li><input checked="" type="checkbox"/> (Enabled)</li> </ul>

\*1 This setting is used to adjust the line width of vector graphics. Except for CAD and other specialized uses, there is normally no need to change this setting. When "0" is selected, all lines are printed at a width of 1 dot.

\*2 Paper sizes that can be used with this function are 8-1/2" x 11", 8-1/2" x 14", and A4. (This function may not take effect with some print methods.)

\*3 Only effective when printing PDF, JPEG, and TIFF files.

\*4 When a finisher is installed.

## PCL Settings

This is used to set the symbol sets, fonts, and line feed code used in a PCL environment.

### Settings

Item	Description	Selections
PCL Symbol Set Setting	Specify the symbol set used for printing.	Select from 35 items.
PCL Font Setting	Use this to select the font used for printing.	<ul style="list-style-type: none"> <li>Internal Font</li> <li>Extended Font</li> </ul> (List of internal fonts when extended fonts are not installed.)
PCL Line Feed Code	This setting is used to select how the printer responds when a line feed command is received.	<ul style="list-style-type: none"> <li>0.CR=CR; LF=LF; FF=FF</li> <li>1.CR=CR+LF; LF=LF; FF=FF</li> <li>2.CR=CR; LF=CR+LF; FF=CR+FF</li> <li>3.CR=CR+LF; LF=CR+LF; FF=CR+FF</li> </ul>
Wide A4	When this is enabled, 80 characters per line can be printed on A4 size paper using a 10-pitch font. (When this setting is disabled, up to 78 characters can be printed per line.)	<ul style="list-style-type: none"> <li><input checked="" type="checkbox"/> (Enabled)</li> <li><input type="checkbox"/> (Disabled)</li> </ul>

# PostScript Setting

When an error occurs during PostScript printing, these settings determine whether or not an error notice is printed and whether or not the PostScript data is received in binary format.

## Settings

Item	Description	Selections
Print PS Error	When a PS (PostScript) error occurs during PostScript printing, this setting determines whether or not an error notice is printed.	<ul style="list-style-type: none"><li><input checked="" type="checkbox"/> (Enabled)</li><li><input type="checkbox"/> (Disabled)</li></ul>
Binary Processing	Receive PostScript data in binary format.	<ul style="list-style-type: none"><li><input checked="" type="checkbox"/> (Enabled)</li><li><input type="checkbox"/> (Disabled)</li></ul>



# Document Filing Control

Document Filing Control is used to create, edit, and delete custom folders for document filing. Touch the [Document Filing Control] key to configure the settings.

When the [Document Filing Control] key is touched, the following screen will appear.

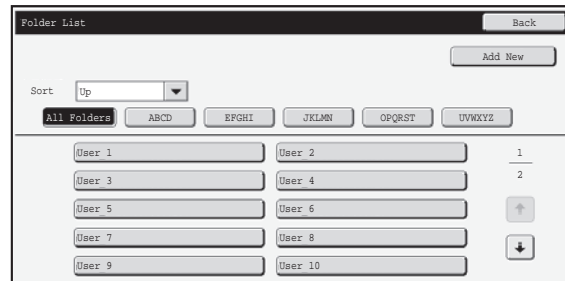

- **[Add New] key**

Use this to add a new custom folder.

- **List display**

This displays a list of the currently configured custom folders. A folder can be selected to open an edit/delete screen for the folder.

## Creating a custom folder

Touch the [Add New] key in the above screen to open a registration screen. Up to 1000 custom folders can be created. For more information, see "[Settings](#)" (page 7-29).

## Editing/deleting a custom folder

A custom folder can be selected from the list in the above screen to open an edit/delete screen for the folder.

For more information, see "[Settings](#)" (page 7-29).

Delete a folder with the [Delete] key.



- If the folder has a password, the correct password must be entered before a file can be deleted.
- A folder that contains files cannot be deleted. Either move the files to a different folder or delete them before deleting the folder.

## Settings

Item	Description
Folder Name	Enter a name (maximum of 28 characters) for the custom folder to be created. A name cannot be stored if it is already being used for another folder.
Initial of Folder	Enter up to 10 characters for the initials. The initials you enter here determine the position of the one-touch key in the alphabetical index.
Password of Folder	To set a password for the folder, enter the desired number (5 to 8 digits).
Select User Name	Select the desired user name from the user list.

---

---

# USB-Device Check

This lets you check the connection when a USB device is connected to the machine. Touch the [USB-Device Check] key to check the connection.



The status of a USB device that is not compatible with the machine will not appear.

# User Control

This section explains settings for user control. Touch the [User Control] key to configure the settings.



- User Control settings can only be configured when "[User Authentication Setting](#)" (page 7-51) is enabled.
- Depending on the user that logged in, it may not be possible to use the settings below.

## Modify User Information

The information of the currently logged in user can be edited.

### Settings

Item	Description
User Name	Edit the name of the user (max. 32 characters). This user name is used as the key name in the login screen, the document filing user name, and the sender name. (The user name must be unique.)
Initial	Edit the initials (maximum of 10 characters). The initials determine where the user name will appear in the user name list.
Index	Select the desired custom index. The custom index names are the same as those in the address book.
Login Name	This cannot be edited.
Password	Enter the password used for user authentication by login name and password (1 to 32 characters). (The password can be omitted.)
My Folder	This cannot be edited.
E-mail Address	This cannot be edited.
Authentication Settings	This cannot be edited.
Pages Limit Group	This cannot be edited.
Authority Group	This cannot be edited.
Favorite Operation Group	The favorite operation group that will be applied at login appears. Check with your administrator for the settings of the Favorite Operation Groups.
User Number	This cannot be edited.
Deleting an account	This cannot be edited.



The items that appear will vary depending on the user authentication method that is enabled.

# SYSTEM SETTINGS (ADMINISTRATOR)

This section explains the system settings that are configured by the administrator of the machine.

## Accessing the System Settings (Administrator)

To access the system settings (administrator), the administrator must log in as explained below.

### When User Authentication is not Enabled

When "User Authentication Setting" (page 7-51) is not enabled, follow the procedure below to log in.

1

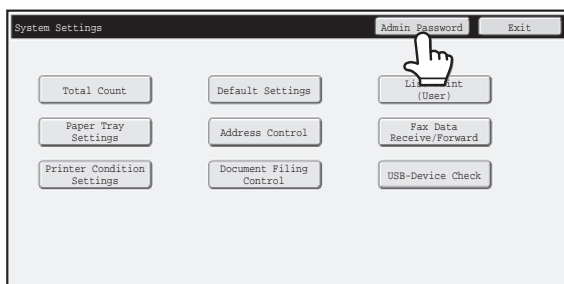

Touch the [Admin Password] key.

2

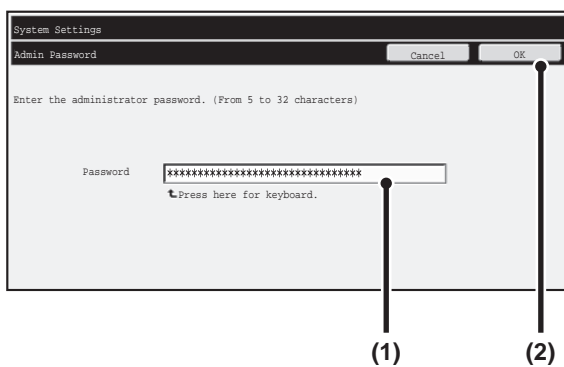

Log in.

- (1) Touch the [Password] text box and enter the administrator password.
- (2) Touch the [OK] key.



This completes the administrator login procedure. The system settings (administrator) can now be used.



- User authentication is initially disabled (factory default setting).

- **To logout...**

Touch the [Logout] key in the top right corner of the screen. You can also touch the [Exit] key to quit the system settings. (If Auto Clear activates, logout will automatically take place.)

# When User Authentication is Enabled

When "User Authentication Setting" (page 7-51) is enabled, follow the procedure below to log in.

 When auto login is enabled, the login screen will not appear.

## When user authentication is by login name and password (and e-mail address)

 Administrator login is performed in the user selection screen. For more information on the login procedure when user authentication is enabled, see "USER AUTHENTICATION" (page 1-17) in "1. BEFORE USING THE MACHINE".

1

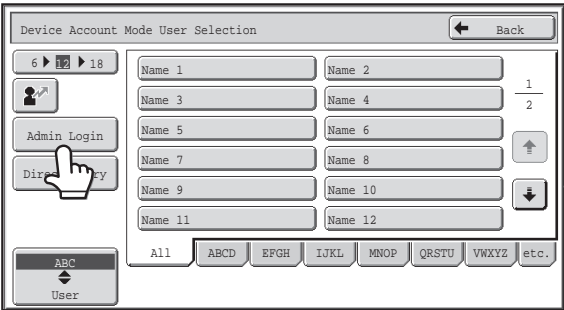

**Touch the [Admin Login] key.**

2

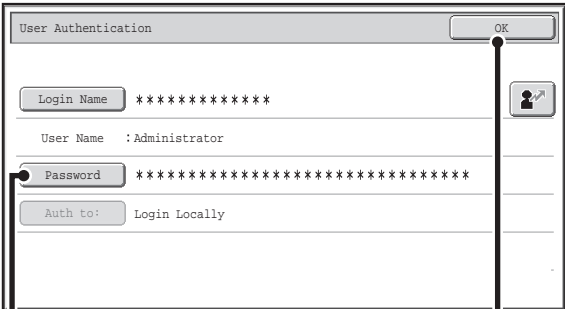

**Log in.**

**(1) Touch the [Password] key.**  
Enter the administrator password in the administrator password entry screen.

**(2) Touch the [OK] key.**

-  • If login name / password / e-mail address is selected for the authentication method, the [E-mail Address] key will appear below the "User Name".
- For the factory default administrator password, see "TO THE ADMINISTRATOR OF THE MACHINE" in the Start Guide.
- This completes the administrator login procedure. The system settings (administrator) can now be used.

## Login by user number



### Touch the [Admin Login] key.

Enter the administrator password in the administrator password entry screen.

This completes the administrator login procedure. The system settings (administrator) can now be used.



- In addition to login by touching the [Admin Login] key, the system settings (administrator) can also be accessed when login is performed by selecting a user with administrator rights from the user list or by entering a user number with administrator rights. For more information on login procedures when user authentication is enabled, see "[USER AUTHENTICATION](#)" (page 1-17) in "1. BEFORE USING THE MACHINE".

- **To logout...**

Press the [LOGOUT] (⊛) key. (Except when entering a fax number.)  
(If Auto Clear activates, logout will automatically take place.)

# System Settings (Administrator) List

The system settings that appear following administrator login are shown below. The default setting for each item is also shown.



- Depending on the machine specifications and peripheral devices installed, it may not be possible to use some settings.
- For information on the general settings, see "[System Settings \(General\) List](#)" (page 7-6).
- For explanations of settings related to the fax function, see "[SYSTEM SETTINGS FOR FAX](#)" (page 7-101).

## User Control

Item	Factory default setting	Page
■ <b>User Control</b>		7-51
● <b>User Authentication Setting</b>		7-51
▶ <b>User Authentication</b>	Disabled	7-51
▶ <b>Authentication Method Setting</b>	Authenticate a User by Login Name and Password	7-51
▶ <b>Device Account Mode Setting</b>	Disabled	7-51
● <b>Other Settings</b>		7-52
▶ <b>Actions when the Limit of Pages for Output Jobs</b>	Job is Completed even when the Limit of Pages is Reached	7-52
▶ <b>The Number of User Name Displayed Setting</b>	12	7-52
▶ <b>A Warning when Login Fails</b>	Disabled	7-52
▶ <b>Disabling of Printing by Invalid User</b>	Disabled	7-52
▶ <b>Automatically print stored jobs after login</b>	Disabled	7-52
▶ <b>Default Network Authentication Server Setting</b>	–	7-52
▶ <b>Display Usage Status after Login</b>	–	7-52
▶ <b>User Information Print</b>	–	7-52
● <b>User List</b>	–	7-53
● <b>Page Limit Group List</b>	–	7-55
● <b>Authority Group List</b>	–	7-56
● <b>Favorite Operation Group List*<sup>1</sup></b>	–	7-59
▶ <b>Favorite Operation Group Registration*<sup>1</sup></b>	–	7-59
▶ <b>My Menu List</b>	–	7-60
● <b>User Count</b>	–	7-61
● <b>Card Settings*<sup>2</sup></b>		7-62
▶ <b>Card Reader Device Registration</b>		7-62

\*1 This cannot be set on the machine. Set this in "User Control" in the Web pages.

\*2 When the HID card reader is available.

## Energy save

Item	Factory default setting	Page
■ Energy Save		7-63
● Toner Save Mode		7-63
▶ Print	Disabled	
▶ Copy	Disabled	
● Auto Power Shut-Off	Enabled	7-63
● Auto Power Shut-Off Timer	10 min.	7-63
● Preheat Mode Setting	1 min.	7-63

## Operation Settings

Item	Factory default setting	Page
■ Operation Settings		7-64
● Other Settings		7-64
▶ Keys Touch Sound	Middle	7-64
◆ Key Touch Sound at Initial Point	Disabled	
▶ Auto Clear Setting	60 sec.	7-64
◆ Cancel Auto Clear Timer	Disabled	
▶ Message Time Setting	6 sec.	7-64
▶ MFP Display Language Setting	American English	7-64
▶ Disabling of JJob Priority Operation	Disabled	7-64
▶ Disabling of Bypass Printing	Disabled	7-64
▶ Key Operation Setting	0.0 sec.	7-64
◆ Disable Auto Key Repeat	Disabled	
▶ Disabling of Clock Adjustment	Disabled	7-64
▶ Business Card Scan Option*1	Disabled	7-64
▶ Set Keyboard Priority*2	External keyboard	7-65
▶ Initial Original Count Setting*2	All disabled	7-65
● MFP Display Pattern Setting	Pattern 4	7-65
● Customize Key Setting*3		7-65
▶ Copy		
◆ Customize 1	File	
◆ Customize 2	Quick File	
◆ Customize 3	–	
▶ Scan		
◆ Customize 1	Address Review	
◆ Customize 2	File	
◆ Customize 3	Quick File	



Item	Factory default setting	Page
▶ Internet Fax*4		7-65
◆ (Same as Scan)		
▶ Fax*5		
◆ (Same as Scan)		
▶ USB Memory Scan		
◆ Customize 1	–	
◆ Customize 2	–	
◆ Customize 3	–	
▶ Data Entry*6		
◆ (Same as Scan)		
● Home Screen Settings*3	–	7-66
● My Menu Settings*3	–	7-66
● Preview Setting		7-67
▶ Default Preview*2	All Disabled	
▶ Default Preview Display		
◆ Copy*2	Full Page	
◆ Image Send	Scan Send: Full Page*2 Internet Fax Send: Full Page*2 Fax Send: Full Page*2 Data Entry: Full Page*2 USB Memory: Full Page*2 Reception Data: Twice Memory Box: Twice	
◆ Doc. Filing	Image Check: Twice Scan to HDD: Full Page*2	
▶ Received Data Image Check Setting	Disabled	
▶ Default List/Thumbnail Display	List	
● Remote Operation Settings		
▶ Remote Software Operation		
◆ Operational Authority	Prohibited	
◆ View Password Entry Screen	Display in Both PC and MFP	
▶ Operation from Specified PC		
◆ Operational Authority	Prohibited	
◆ Hostname or IP Address of PC	–	
◆ View Password Entry Screen	Display in Both PC and MFP	
▶ Operation by User who Has Password		
◆ Operational Authority	Prohibited	
◆ View Password Entry Screen	Display in Both PC and MFP	

\*1 MX-B402 Only

\*2 MX-B402SC Only

\*3 This cannot be set on the machine. Set this in the system settings in the Web pages.

\*4 When the Internet fax expansion kit is installed.

\*5 When the facsimile expansion kit is installed.

\*6 When the application integration module is installed.

## Device Control

Item	Factory default setting	Page
■ Device Control		7-69
● Other Settings		7-69
▶ AB/Inch Type Setting	Inch	7-69
▶ Default Original Size Settings	Copy: None Fax/Image Send: 8-1/2" x 11" Scan to HDD: 8-1/2" x 11"	7-69
▶ Setting of Default Original Exit Place	Upper Exit	7-69
▶ Original Feeding Mode	All Disabled	7-69
▶ Auto Paper Selection Setting	Plain Paper	7-69
▶ Detect Standard in Auto Color Mode	3	7-69
▶ Optimization of a Hard Disk	–	7-70
▶ Clear All Job Log Data	–	7-70
● Disabling of Devices		7-71
▶ Disabling of Document Feeder	Disabled	7-71
▶ Disabling of Duplex	Disabled	7-71
▶ Disabling of Optional Paper Feed Unit*2	Disabled	7-71
▶ Disabling of Tray Settings	Disabled	7-71
▶ Disabling of Offset*3	Disabled	7-71
▶ Disabling of Stapler*3	Disabled	7-71
● Fusing Control Settings	16 - 23 lbs. (60 - 89g/m <sup>2</sup> )	7-71

\*1 MX-B402SC Only

\*2 When a 500-sheet paper feed unit is installed.

\*3 When a finisher is installed.

## Copy Function Settings

Item	Factory default setting	Page
■ Copy Function Settings		7-72
● Initial Status Settings		7-72
▶ Paper Tray	Tray 1	
▶ Exposure Type	Auto	
▶ Copy Ratio	100%	
▶ 2-Sided Copy	1-Side to 1-Side	
▶ Output	Auto	
● Other Settings		7-73
▶ Copy Exposure Adjustment	5	7-73
▶ Add or Change Extra Preset Ratios	–	7-73
▶ Setting a Maximum Number of Copies	999	7-73
▶ Initial Margin Shift Setting		7-73
◆ Side 1	1/2"	
◆ Side 2	1/2"	
▶ Erase Width Adjustment		7-73
◆ Edge Clearance Width	1/2"	
▶ Card Shot Settings		7-73
◆ Original Size	X: 3-3/8", Y: 2-1/8"	
◆ Fit to Page	Disabled	
▶ Disabling Deletion of Job Programs	Disabled	7-73
▶ Disabling of Bypass-Tray in Duplex Copy	Disabled	7-73
▶ Disabling of Auto Paper Selection	Disabled	7-73
▶ Auto Selection of Paper Tray that was Last Loaded	Disabled	7-74
▶ 600dpi x 600dpi Scanning Mode for Document Feeder	Disabled	7-74
▶ Quick Scan from Document Glass	Disabled	7-74

## Network Settings

Item	Factory default setting	Page
■ Network Settings		7-75
● IPv4 Settings	DHCP	7-75
● IPv6 Settings	Disabled	7-75
● Enable TCP/IP	Enabled	7-75
● Enable NetWare	Enabled	7-75
● Enable EtherTalk	Enabled	7-75
● Enable NetBEUI	Enabled	7-75
● Reset the NIC	–	7-75
● Ping Command	–	7-75

## Printer Settings

Item	Factory default setting	Page
■ Printer Settings		7-76
● Default Settings		7-76
▶ Prohibit Notice Page Printing	Enabled	7-76
▶ Prohibit Test Page Printing	Disabled	7-76
▶ A4/Letter Size Auto Change	Disabled	7-76
▶ Print Density Level	3	7-76
▶ Bypass Tray Settings		7-76
◆ Enable Detected Paper Size in Bypass Tray	Disabled	7-76
◆ Enable Selected Paper Type in Bypass Tray	Enabled	7-76
◆ Exclude Bypass-Tray from Auto Paper Select	Disabled	7-76
▶ Job Spool Queuing	Enabled	7-76
● Interface Settings		7-77
▶ Hexadecimal Dump Mode	Disabled	7-77
▶ I/O Timeout	60 sec.	7-77
▶ Enable USB Port	Enabled	7-77
▶ USB Port Emulation Switching	Auto	7-77
▶ Enable Network Port	Enabled	7-77
▶ Network Port Emulation Switching	Auto	7-77
▶ Port Switching Method	Switch at End of Job	7-77

## Image Send Settings

Item	Factory default setting	Page
■ Image Send Settings		7-78
● Operation Settings		7-78
▶ Other Settings		7-78
◆ Default Display Settings	Scan (fax when fax option is installed)	7-78
• Hold settings for a while after scanning has been completed	Disabled	
• Switch Automatically to Copy Mode Screen	Enabled	
◆ Address Book Default Selection	Tab Switch: ABC, Address Type: All	7-78
◆ Initial Resolution Setting		7-78
• Scan	Apply the Resolution Set when Stored: Disabled 200 X 200 dpi	
• Internet Fax* <sup>1</sup>	Apply the Resolution Set when Stored: Disabled 200 X 100 dpi	
• Fax* <sup>2</sup>	Apply the Resolution Set when Stored: Disabled Standard	
◆ Default Exposure Settings	Auto	7-78
• Original Image Type	Text	
• Moiré Reduction	Disabled	
◆ Must Input Next Address Key at Broadcast Setting	Disabled	7-79
◆ Scan Complete Sound Setting	Middle	7-79
◆ The Number of File Name/Subject/Body Keys Displayed Setting	12	7-79
◆ The Number of Direct Address Keys Displayed Setting	10	7-79
◆ Disable Switching of Display Order	Disabled	7-79
◆ Hold Setting for Received Data Print* <sup>3</sup>	Disabled	7-79
◆ Erase Width Adjustment		7-79
• Edge Clearance Width	1/2"	

Item	Factory default setting	Page
▶ Settings to Disable Registration		7-79
◆ Disable Registering Destination from Operation Panel	All disabled	7-79
◆ Disable Registering Destination on Web Page*4	All disabled	7-79
◆ Disable Registration of Program	All disabled	7-80
◆ Disable Registration of Memory Box	All disabled	7-80
◆ Disable Destination Registration Using Global Address Search*4	All disabled	7-80
◆ Disable Registration Using Network Scanner Tool*4	Disabled	7-80
▶ Settings to Disable Transmission		7-80
◆ Disable [Resend] on Image Send Mode	Disabled	7-80
◆ Disable Selection From Address Book	All disabled	7-80
◆ Disable Direct Entry	All disabled	7-80
◆ Disable PC-I-Fax Transmission*1	Disabled	7-80
◆ Disable PC-Fax Transmission*2	Disabled	7-80
▶ Own Name and Destination Set		7-81
◆ Sender Data Registration		
• Sender Name	–	
• Sender Fax Number*2	–	
• I-Fax Own Address*1	–	
◆ Registration of Own Name Select	–	7-81
● Scan Settings		7-82
▶ Other Settings		7-82
◆ Default Sender Set	–	7-82
◆ Default Color Mode Settings	Mono 2	7-82
• Disable Change of B/W Setting in Auto Mode	Disabled	
◆ Initial File Format Setting		7-82
• File Type	PDF	
• Black & White	MMR (G4)	
• Color/Grayscale	Medium	
• Specified Pages per File	Disabled	
• Number of Pages	Disabled	

Item	Factory default setting	Page
◆ Compression Mode at Broadcasting		7-82
• Black & White	MH (G3)	
• Color/Grayscale	Medium	
◆ Maximum Size of E-mail Attachments (E-mail)	Unlimited	7-83
◆ Maximum Size of Data Attachments (FTP/Desktop/Network Folder)	Unlimited	7-83
◆ Bcc Setting		7-83
• Enable Bcc	Disabled	
• Display Bcc Address on the Job Status Screen	Disabled	
◆ Disable Scan Function		7-83
• USB Memory Scan	Disabled	
• PC Scan	Disabled	
◆ Pre-Setting Mail Signature	Disabled	7-83
▶ Default Address Setting	Disabled	7-83
● I-Fax Settings*1		7-84
▶ I-Fax Default Settings		7-84
◆ Auto Wake Up Print	Enabled	7-84
◆ Compression Setting	MH (G3)	7-84
◆ Speaker Volume Setting	–	7-84
• Receive Signal	Middle	
• Communication Error Signal	Middle	
◆ Original Print on Transaction Report	Print Out Error Report Only	7-84
◆ Transaction Report Print Select Setting		7-84
• Single Sending	Print Out Error Report Only	
• Broadcasting	Print Out All Report	
• Receiving	No Printed Report	
◆ Activity Report Print Select Setting		7-85
• Auto Print at Memory Full	Disabled	
• Print Daily at Designated Time	Disabled	
◆ Body Text Print Select Setting	Disabled	7-85
◆ Pre-Setting Mail Signature	Disabled	7-85

Item	Factory default setting	Page
▶ I-Fax Send Settings		7-85
◆ I-Fax Reception Report On/Off Setting	Disabled	7-85
◆ I-Fax Reception Report Request Timeout Setting	1 hour	7-85
◆ Number of Resend Times at Reception Error	2	7-85
◆ Maximum Size of E-mail Attachments	Unlimited	7-85
◆ Rotation Sending Setting	All Enabled	7-86
◆ Printing Page Number at Receiver	Enabled	7-86
◆ Recall in Case of Line Busy	Times: 2, Interval 3 min.	7-86
◆ Recall in Case of Communication Error	Times: 2, Interval 3 min.	7-86
▶ I-Fax Receive Settings		7-86
◆ Auto Receive Reduce Setting	Enabled	7-86
◆ Duplex Reception Setting	Disabled	7-86
◆ Set Address for Data Forwarding	–	7-86
• Direct SMTP	Disabled	
• Add Hostname or IP Address.	Disabled	
• Hostname or IP Address	–	
◆ Receiving Date & Time Print	Disabled	7-87
◆ POP3 Communication Timeout Setting	60 sec.	7-87
◆ Reception Check Interval Setting	5 min.	7-87
▶ Allow/Reject Mail or Domain Name Setting	All Invalid	7-87

\*1 When the Internet fax expansion kit is installed.

\*2 When the facsimile expansion kit is installed.

\*3 When the Internet fax expansion kit or facsimile expansion kit is installed.

\*4 When network connection is enabled.



## Document Filing Settings

Item	Factory default setting	Page
■ Document Filing Settings		7-88
● Other Settings		7-88
▶ Default Mode Settings	Sharing Mode	7-88
▶ Sort Method Setting	Date	7-88
▶ Administrator Authority Setting		7-88
◆ Delete File	Disabled	
◆ Delete Folder	Disabled	
◆ Change Password	Disabled	
▶ Delete All Quick Files		7-88
◆ Delete	–	
◆ Delete quick files at power up (protected files excluded)	Enabled	
▶ Default Color Mode Settings	Mono 2	7-88
▶ Default Exposure Settings	Auto	7-88
◆ Original Image Type	Text	
◆ Moiré Reduction	Disabled	
▶ Initial Resolution Settings	600 x 600 dpi	7-88
▶ Scan Complete Sound Setting	Middle	7-89
▶ Disable Stamp for Reprinting	Disabled	7-89
▶ Batch Print Settings		7-89
◆ Selection of [All Users] is not allowed.	Enabled	
◆ Selection of [User Unknown] is not allowed.	Enabled	
▶ Erase Width Adjustment		7-89
◆ Edge Clearance Width	1/2"	
▶ Card Shot Settings		7-89
◆ Original Size	X: 3-3/8", Y: 2-1/8"	
◆ Fit to Store Size	Disabled	

Item	Factory default setting	Page
● Document Output Options		
▶ Print		
◆ Copy	Enabled	7-90
◆ Print	Enabled	
◆ Scan Send	Disabled	
◆ Internet Fax Send (Incl. PC-I-Fax)*1	Disabled	
◆ Fax Send (Incl. PC-Fax)*2	Disabled	
◆ Scan to HDD	Enabled	
▶ Scan Send		
◆ Copy	Disabled	
◆ Scan Send	Enabled	
◆ Internet Fax Send (Incl. PC-I-Fax)*1	Disabled	
◆ Fax Send (Incl. PC-Fax)*2	Disabled	
◆ Scan to HDD	Enabled	
▶ Internet Fax Send*1		
◆ Copy	Disabled	
◆ Scan Send	Disabled	
◆ Internet Fax Send (Incl. PC-I-Fax)	Enabled	
◆ Fax Send (Incl. PC-Fax)	Disabled	
◆ Scan to HDD	Disabled	
▶ Fax Send*2		7-90
◆ Copy	Disabled	
◆ Scan Send	Disabled	
◆ Internet Fax Send (Incl. PC-I-Fax)*1	Disabled	
◆ Fax Send (Incl. PC-Fax)*2	Enabled	
◆ Scan to HDD	Disabled	
● Automatic Deletion of File Settings	All invalid	7-90

\*1 When the Internet fax expansion kit is installed.

\*2 When the facsimile expansion kit is installed.

## List Print (Administrator)

Item	Factory default setting	Page
■ List Print (Administrator)		7-91
● Administrator Settings List	–	7-91
● Image Sending Activity Report	–	7-91
● Data Receive/Forward List	–	7-91
● Web Settings List*1	–	7-91
● Metadata Set List*2	–	7-91

\*1 When network connection is enabled.

\*2 When the application integration module is installed.

## Security Settings

Item	Factory default setting	Page
■ Security Settings		7-92
● SSL Settings		7-92
▶ Server Port		
◆ HTTPS	Enabled	
◆ IPP-SSL	Disabled	
◆ Redirect HTTP to HTTPS in Device Web Page Access	Disabled	
▶ Client Port		
◆ HTTPS	Enabled	
◆ FTPS	Enabled	
◆ SMTP-SSL	Enabled	
◆ POP3-SSL	Enabled	
◆ LDAP-SSL	Enabled	
◆ Level of Encryption	Low	
● IPsec Settings	Disabled	7-92
● IEEE802.1X Setting	Disabled	7-92

## Enable/Disable Settings

Item	Factory default setting	Page
■ Enable/Disable Settings		7-93
● Printer Condition Settings		7-93
▶ Disable Blank Page Print	Disabled	7-93
● User Control		7-93
▶ Disabling of Printing by Invalid User	Disabled	7-93
● Operation Settings		7-93
▶ Cancel Auto Clear Timer	Disabled	7-93
▶ Disabling of Job Priority Operation	Disabled	7-93
▶ Disabling of Bypass Printing	Disabled	7-93
▶ Disable Auto Key Repeat	Disabled	7-93
▶ Disabling of Clock Adjustment	Disabled	7-93
● Device Control		7-93
▶ Disabling of Document Feeder	Disabled	7-93
▶ Disabling of Duplex	Disabled	7-93
▶ Disabling of Optional Paper Feed Unit*1	Disabled	7-93
▶ Disabling of Tray Setting	Disabled	7-93
▶ Disabling of Offset*2	Disabled	7-93
▶ Disabling of Stapler*2	Disabled	7-93
● Copy Function Settings		7-94
▶ Disabling Deletion of Job Programs	Disabled	7-94
▶ Disabling of Bypass-Tray in Duplex Copy	Disabled	7-94
▶ Disabling of Auto Paper Selection	Disabled	7-94
● Printer Settings		7-94
▶ Prohibit Notice Page Printing	Enabled	7-94
▶ Prohibit Test Page Printing	Disabled	7-94
▶ Exclude Bypass-Tray from Auto Paper Select	Disabled	7-94

Item	Factory default setting	Page
● Image Send Settings		7-94
▶ Other Disabling		7-94
◆ Disable Switching of Display Order	Disabled	7-94
◆ Disable Scan Function		7-94
• PC Scan	Disabled	
• USB Memory Scan	Disabled	
▶ Settings to Disable Registration		7-94
◆ Disable Registering Destination from Operation Panel	All disabled	7-94
◆ Disable Registering Destination on Web Page*3	All disabled	7-95
◆ Disable Registration of Program	All disabled	7-95
◆ Disable Registration of Memory Box	All disabled	7-95
◆ Disable Destination Registration Using Global Address Search*3	All disabled	7-95
◆ Disable Registration Using Network Scanner Tools*3	Disabled	7-95
▶ Settings to Disable Transmission		7-95
◆ Disable [Resend] on Image Send Mode	Disabled	7-95
◆ Disable Selection from Address Book	All disabled	7-95
◆ Disable Direct Entry	All disabled	7-95
◆ Disable PC-I-Fax Transmission*4	Disabled	7-95
◆ Disable PC-Fax Transmission*5	Disabled	7-95
● Document Filing Settings		7-95
▶ Disable Stamp for Reprinting	Disabled	7-95
▶ Batch Print Settings		7-95
◆ Selection of [All Users] is not allowed.	Enabled	
◆ Selection of [User Unknown] is not allowed.	Enabled	

\*1 When a 500-sheet paper feed unit is installed.

\*2 When a finisher is installed.

\*3 When network connection is enabled.

\*4 When the Internet fax expansion kit is installed.

\*5 When the facsimile expansion kit is installed.

## Change Administrator Password

Item	Factory default setting	Page
■ Change Administrator Password	See "TO THE ADMINISTRATOR OF THE MACHINE" in the Start Guide.	7-96

## Product Key

Item	Factory default setting	Page
■ <b>Product Key*</b>		7-97
● Serial Number	–	7-97
● Internet Fax Expansion Kit	–	7-97
● E-mail Alert and Status	–	7-97
● Application Integration Module	–	7-97
● Application Communication Module	–	7-97
● External Account Module	–	7-97
● XPS Expansion Kit	–	7-97

\* It may not be possible to use some settings, depending on the peripheral devices installed.

## Data Backup

Item	Factory default setting	Page
■ <b>Data Backup</b>		7-98
● Storage Backup	–	7-98
● Device Cloning	–	7-98

## Storing/Calling of System Settings

Item	Factory default setting	Page
■ <b>Storing/Calling of System Settings</b>		7-99
● Restore Factory Defaults	–	7-99
● Store Current Configuration	–	7-99
● Restore Configuration	–	7-99

## Sharp OSA Settings

Item	Factory default setting	Page
■ <b>Sharp OSA Settings*</b>		7-100
● External Account Setting		7-100
▶ External Account Control	Disabled	
▶ Enable Authentication by External Server	Disabled	
● USB Driver Settings		7-100
▶ External Keyboard	Internal driver	
▶ USB Memory	Internal driver	
▶ Level of Encryption	None	
● Job Priority Preference	Standard	7-100

\* When the external account module or application communication module is available.

# User Control

User Control is used to configure settings for user authentication. Touch the [User Control] key to configure the settings.

## User Authentication Setting

These settings enable or disable user authentication and specify the authentication method.

When user authentication is enabled, each user of the machine is registered. When a user logs in, settings for that user are applied. This function allows greater control of security and cost management.

In addition, even if the user information is not stored in the machine, it is possible to log in by directly entering user information stored on a LDAP server. In this case, the login user will be the factory-stored "User". For more information, see "[Factory-stored users](#)" (page 7-53).

-  • For the procedure for storing users, see "[User List](#)" (page 7-53).
- For more information on login procedures when user authentication is enabled, see "[USER AUTHENTICATION](#)" (page 1-17) in "1. BEFORE USING THE MACHINE".

## User Authentication

When [User Authentication] is enabled, the login screen appears before an operation is begun in any mode except the job status screen\*. You must log in as one of the stored users. (After logging in, you can move freely through the modes.)

\* The login screen appears when a document filing file is used or when a broadcast transmission is reattempted from the job status screen.

-  • The login screen will vary depending on the authentication method that is selected. For more information, see "[USER AUTHENTICATION](#)" (page 1-17) in "1. BEFORE USING THE MACHINE".
- When "Authenticate a User by User Number Only" is selected for the authentication method, network authentication cannot be used.

## Authentication Method Setting

This selects the authentication method. When using user authentication, be sure to configure this setting first. The items configured for users stored after the user authentication method is set vary depending on the selected authentication method.

### Authenticate a User by Login Name and Password

Standard authentication method using a login name and password.

### Authenticate a User by Login Name, Password and E-mail Address

In addition to a login name and password, this authentication method also requires the entry of an e-mail address.

### Authenticate a User by User Number Only

This can be used as a simple authentication method when network authentication is not used.

## Device Account Mode Setting

A specific user can be stored as an auto login user. When this setting is enabled, login can be performed automatically.

This function eliminates the bother of logging in but still allows the settings of the selected user (network settings, favorite operations, etc.) to be applied. You can also allow users other than the auto login user to temporarily log in and work using their own authority and settings. To allow other users to log in temporarily when [Device Account Mode] is enabled, select [Allow Login by Different User].

For example, you can require authentication for one-sided copying only.

-  • If auto login fails for some reason when auto login is enabled, or the login user does not have administrator rights, all system settings or the system settings (administrator) will lock. In this event, the administrator should touch the [Admin Password] key in the system settings screen and log in again.
- To log in as a user other than the auto login user when [Allow Login by Different User] is enabled, press the [LOGOUT] key (⊗) to cancel the auto user login state. The user authentication screen will appear to let you log in. After using the machine, press the [LOGOUT] key (⊗) to log out.

## Other Settings

### Actions when the Limit of Pages for Output Jobs

This setting determines whether or not a job will be completed if the page limit is reached while the job is in progress.

The following selections are available.

- Job is Stopped when the Limit of Pages is Reached
- Job is Completed even when the Limit of Pages is Reached

### The Number of User Name Displayed Setting

The number of users that are displayed in the user selection screen can be selected (6, 12, or 18 users).



This setting also applies to the user selection screen of document filing and the sender selection screen.

### A Warning when Login Fails

This setting is used to display a warning and prohibit login for five minutes if login fails three times in a row. This prevents an unauthorized person from attempting to guess a password. (The number of failed login attempts is retained even if the power is turned off.)



Locking of the operation panel for 5 minutes can be canceled by clicking [User Control] - [Default Settings] - [Release the Lock on Machine Operation Panel] in the Web page menu.

### Disabling of Printing by Invalid User

Printing by users whose information is not stored in the machine, such as printing without entering valid user information in the printer driver or printing of a file on an FTP server from the Web pages, can be prohibited.



When a print job is executed by a user that is not stored in the machine, the factory-stored "Other User" is used as the login user. For more information, see "[Factory-stored users](#)" (page 7-53).

### Automatically print stored jobs after login

When retention is enabled in the printer driver and print data has been spooled to the machine, you can have the spooled print data automatically print out when the user who enabled retention logs in.

### Default Network Authentication Server Setting

Use this to set the default network authentication server. When a user logs in from the Web page or sends a print job to the machine using user information that is not stored on the machine, the authentication server is not known. This setting is used to specify one of the LDAP servers stored on the machine as the authentication server.



When login is performed by network authentication using user information that is not stored in the machine, the login user will be the factory-stored "User". For more information, see "[Factory-stored users](#)" (page 7-53).

### Display Usage Status after Login

When user authentication is enabled, this setting specifies whether or not the page counts of a user appear when the user logs in.

### User Information Print

The following lists can be printed.

- User List
- List of Number of Pages Used
- Page Limit Group List\*
- Authority Group List
- Favorite Operation Group List\*
- All User Information Print

Touch the key of the desired list to begin printing.

\* Cannot be printed when no groups are stored.



# User List

This is used to store, edit, and delete users when user authentication is enabled. When the [User List] key is touched, the following screen appears.

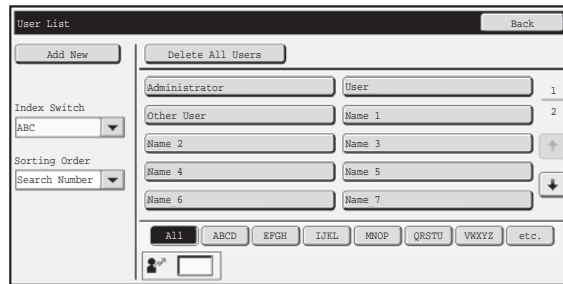

- **[Add New] key**

Use this to add a new user.

- **[Delete All Users] key**

Use this to delete all stored users. (Excluding factory stored users.) This operation can only be performed by an administrator.

- **User List**

This shows the factory-stored users and the currently stored users.

## Storing a user

Touch the [Add New] key in the above screen to open a registration screen. Up to 1000 users can be stored. For more information, see "Settings" (page 7-54).

## Editing/deleting a user

A user can be selected from the list in the above screen to open an edit/delete screen for the user. For more information, see "Settings" (page 7-54).

Delete a user with the [Delete] key.



- When auto login is enabled, "Delete All Users" cannot be used.
- The factory-stored users cannot be deleted.

## Factory-stored users

The following users are stored in the machine at the factory.

- **Administrator:** Factory-stored account for the administrator of the machine.
- **User:** This is used when network authentication is used and a login name not stored in the machine is directly entered. (This cannot be selected in the login user screen.)
- **Other User:** This is used when a print job is executed using invalid user information. (This cannot be selected in the login user screen.)

For settings related to each of the users, see the following table.

User Name	Administrator	User	Other User
Login Name	admin	users	Other
Password	(See the Start Guide.)* 1	users*1	–
My Folder	Main Folder		
Authentication Settings	Login Locally		–
Pages Limit Group	Unlimited*1		
Authority Group*2	Admin	User*1	Guest*1

<b>Favorite Operation Group</b>	Following the System Settings*1
<b>Card Settings*3</b>	Not set

\*1 Items that can be changed.

\*2 For detailed information of each of the settings, see "[List of settings and factory default settings of template groups](#)" (page 7-57).

\*3 When the HID card reader is enabled.

## Settings

Item	Description
User Name	Store the name of the user (max. 32 characters). This user name is used as the key name in the login screen, the document filing user name, and the sender name. (The user name must be unique.)
Apply User Name to Log-in Name*1	Touch this key to enter the user name in the login name.
Initial	This determines where the user name will appear in the user list. Up to 10 characters can be entered.
Index	Select the desired custom index. The custom index names are the same as those in the address book.
User Number*2	Enter a user number (5 to 8 digits).
Login Name*1	Enter the login name used when authentication by login name/password is enabled (maximum of 255 characters). (The login name must be unique.)
Password*1, 3	Enter the password used when authentication by login name/password is enabled (1 to 32 characters). (The password can be omitted.)
E-mail Address	Enter the e-mail address used in the sender list and for LDAP authentication (maximum of 64 characters).
My Folder	A folder ("My Folder") can be specified as the folder used by the user for document filing. A previously created folder can be selected or you can create and select a new folder.
Authentication Settings*1	Select [Login Locally] or [Network Authentication] (when LDAP is enabled) for "Authenticate to:".
Authentication Server	When [Network Authentication] is selected, select the server to be used for user authentication from the list of LDAP servers stored in the Web pages.
Pages Limit Group	Specify page limits for the user by selecting one of the stored page limit groups. The factory default setting is [Unlimited]. For more information, see " <a href="#">Page Limit Group List</a> " (page 7-55).
Authority Group	Specify the authority of the user by selecting one of the stored authority groups. The factory default setting is [User]. For more information, see " <a href="#">Authority Group List</a> " (page 7-56).
Favorite Operation Group	The favorite operation group that will be applied at login appears. The factory default setting is [Following the System Settings]. The setting can be changed in the [User Control] menu in the Web pages.

\*1 Does not appear when "User Number" is selected for the authentication method.

\*2 Only appears when "User Number" is selected for the authentication method.

\*3 Not required when network authentication is used, as the password stored in the LDAP server is used.

# Page Limit Group List

This is used to store groups of Account Limit Settings. The page limits for each user are specified by selecting one of these stored groups when the user is stored.

When the [Page Limit Group List] key is touched, the following screen appears.

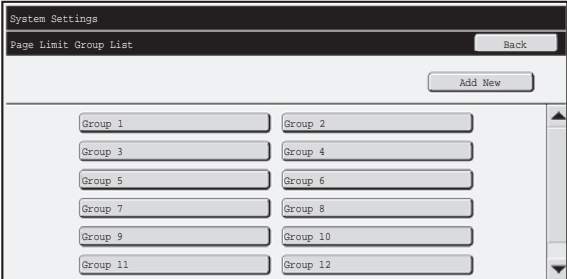

- **[Add New] key**  
Use this to add a new group.

- **List display**  
This shows the currently stored groups. A group name can be selected to open an edit/delete screen for that group.

## Storing a page limit group

Touch the [Add New] key in the above screen to open a registration screen. Up to 20 groups can be stored. For more information, see "[Settings](#)".

## Editing a page limit group

A group can be selected from the list in the above screen to open an edit/delete screen for the group. For information on the settings, see "[Settings](#)". To return a group to the factory default state, set "Select the Group Name to be the Registration Model" to "Unlimited" in the editing screen.

## Settings

Item	Description
Group Name	Store the name of the group (max. 32 characters).
Select the Group Name to be the Registration Model	Select one of the previously stored groups for use as a template for the new group. When selected, the group's settings are applied.
Function names	The names of the functions that can be configured are displayed. Set a limit for each function.
Page Limit	When [Prohibited] is selected for a mode, input and output from the mode are prohibited. When [Unlimited] is selected for a mode, there is no limit to the number of pages that can be input/output in that mode. When [Limited] is selected, enter a limit (1 to 99999999 pages).

# Authority Group List

Use this to store groups of user authority settings. The authority of each user is specified by selecting one of these stored groups when the user is stored.

When the [Authority Group List] key is touched, the following screen appears.

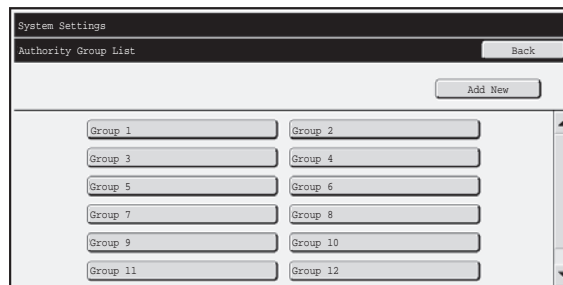

- **[Add New] key**

Use this to add a new group.

- **List display**

This shows the currently stored groups. A group name can be selected to open an edit/delete screen for that group.

## Storing an authority group

Touch the [Add New] key in the above screen to open a registration screen. Up to 20 groups can be stored.

For information on the settings, see "[List of settings and factory default settings of template groups](#)" (page 7-57).

## Editing an authority group

A group can be selected from the list in the above screen to open an edit/delete screen for the group. For information on the settings, see "[List of settings and factory default settings of template groups](#)" (page 7-57).

To return a group to the factory default state, select [Return to Administrator Authority], [Return to User Authority], or [Return to Guest Authority].

## List of settings and factory default settings of template groups

Item	Description		
Group Name	Store the name of the group (max. 32 characters).		
Select the Group Name to be the Registration Model	Select one of the previously stored groups for use as a template for the new group. When selected, the group's settings are applied. The factory default groups and their settings are shown below.		
	<b>Admin</b>	<b>User</b>	<b>Guest</b>
<b>Copy</b>			
Copy Approval Setting	Allowed	Allowed	Allowed
Special Modes Usage	Allowed	Allowed	Prohibited
<b>Printer</b>			
Printer Approval Setting	Allowed	Allowed	Allowed
FTP Pull Print	Allowed	Allowed	Prohibited
USB Memory Direct Print	Allowed	Allowed	Prohibited
Network Folder Pull Print	Allowed	Allowed	Prohibited
<b>Image Send</b>			
Approval Settings for Each Mode			
<ul style="list-style-type: none"> <li>• E-mail</li> <li>• FTP</li> <li>• Desktop</li> <li>• Network Folder</li> <li>• USB Memory</li> <li>• PC Scan</li> <li>• Internet Fax Send</li> <li>• PC-I-Fax Send</li> <li>• Fax Send</li> <li>• PC-Fax Send</li> </ul>	All allowed	All allowed	All allowed
Color Scan	Allowed	Allowed	Prohibited
Special Modes Usage	Allowed	Allowed	Prohibited
Approval Setting for Addressing			
<ul style="list-style-type: none"> <li>• Approval Setting for Direct Entry</li> <li>• Approval Setting to Use a Local Address Book</li> <li>• Approval Settings to Use a Global Address Book</li> </ul>	All allowed	All allowed	All allowed
<b>Document Filing</b>			
Scan to HDD			
<ul style="list-style-type: none"> <li>• Color Mode Approval Setting</li> </ul>	All allowed	All allowed	Only Black & White Allowed
<ul style="list-style-type: none"> <li>• Special Modes Usage</li> </ul>	Allowed	Allowed	Prohibited

Item	Description		
<b>Prints (Document Filing)</b>			
• Doc. Filing Print Approval Setting	All allowed	All allowed	Allowed
• Special Modes Usage	Allowed	Allowed	Prohibited
• Document Filing Image Check	Allowed	Allowed	Prohibited
<b>Sharp OSA</b>			
Approval Setting to Use a Sharp OSA	Allowed	Allowed	Allowed
<b>Common Functions</b>			
Approval Settings for 2-Sided Print	[1-Sided/2-Sided Approved]	[1-Sided/2-Sided Approved]	[1-Sided/2-Sided Approved]
Output Approval Settings	All allowed	All allowed	All prohibited
<b>MFP Settings</b>			
System Settings Operational Authority			
System Settings*1	Allowed*2	Only user authority settings are allowed	All settings prohibited
Web Settings Operational Authority			
Display of Device/Network Status	Allowed	Allowed	Prohibited
Power Reset		Prohibited	
Machine Identification		Prohibited	
Network Settings		Prohibited	
Application Settings (Excluding Registration of Pre-set Text/Forward Table)		Prohibited	
Registration of Pre-set Text/Forward Table		Allowed	
E-mail Alert and Status		Prohibited	
Job Log Setting		Prohibited	
Port Control/ Filter Settings		Prohibited	
Custom Link Setting		Prohibited	
Operation Manual Download		Allowed	

\*1 For information on each setting, see the system settings (general/administrator) lists.

\*2 All allowed except "Change Administrator Password".

 Depending on the machine specifications and peripheral devices installed, it may not be possible to use some settings.

# Favorite Operation Group List

This is used to store favorite operation groups and My Menu.



This setting can only be configured in the Web pages. It cannot be configured in the touch panel of the machine.

## Favorite Operation Group Registration

Sets of preferred settings can be configured and registered as groups. For example, a user who speaks a different language would normally have to change the display language each time he or she uses the machine; however, by storing the language in a favorite operation group, the language is automatically selected when the user logs in.

### Settings

Item	Description
Group Name	Store the name of the group (max. 32 characters).
Select the Group Name to be the Registration Model	Select one of the previously stored groups for use as a template for the new group. When selected, the group's settings are applied.
<b>Copy</b>	
Initial Status Settings	Select settings for Paper Tray, Exposure Type, Copy Ratio, Duplex, and Output.
<b>Image Send</b>	
Initial Status Settings	Select settings for Resolution, Exposure, Color Mode, File Format, and Original Image Type. Store the default fax sender name and number.
<b>Document Filing</b>	
Scan to HDD: Initial Status Settings	Select settings for Color Mode, Resolution, Exposure and Original Image Type.
<b>System Settings</b>	
AB/Inch Type Setting	AB or inches can be set for the units/values of default settings and entry ranges in each screen.
MFP Display Language Setting	Select the display language.
Key Operation Setting	Set the key input time and Auto Key Repeat setting.
Keys Touch Sound	Set the sound made when keys are touched.
Keyboard Select	Set the language that appears on the keyboard.
MFP Display Pattern Setting	Select the color pattern used in the touch panel.
Automatically print stored jobs after login	When retention is enabled in the printer driver and print data has been spooled to the machine, you can have the spooled print data automatically print out when the user who enabled retention logs in.
My Menu Settings	Select the My Menu.
<b>Preview Setting</b>	
Default Preview Display	Image Send: Select the zoom ratio of the preview that can be displayed when an image is received and in the memory box. Document Filing: Set the zoom ratio of the preview that can be displayed when a stored file is opened.
Default List/Thumbnail Display	Select whether the default display format is list or thumbnails.
<b>Customize Key Setting</b>	
Customize Key Setting	Set customized keys for each mode.

## My Menu List

Home screen settings must be previously stored. Select My Menu when storing a favorite operation group.

### Settings

Item	Description
My Menu Name	Enter a maximum of 32 characters for the home screen name.
Select the My Menu to be the Registration Model	Select one of the previously stored My Menu as a template for the new My Menu. When selected, the My Menu settings are applied.
Display Title	Show a title on the My Menu.
Title	Enter a maximum of 70 characters for the title name.
Display the User Name	Show the currently logged-in user name on the My Menu.
Display the Date and Time	Show the date and time on the My Menu.
Background Image	Select the image that appears in the background of the My Menu.
Design Template	A template for the design of the My Menu can be selected from the list. A sample of the selected template can be viewed.
Layout of Keys on Screen	The layout of the keys in the My Menu is displayed.
Key Number	Select the number of the key that you want to set, referring to "Screen Key Layout".
Key Name	The name of the key selected in "Key Number" can be changed (maximum of 48 characters).
Link Item	Specify the function that you want to use in the key selected in "Key Number".



# User Count

This displays the total number of pages printed by each user.  
When the [User Count] key is touched, the following screen appears.

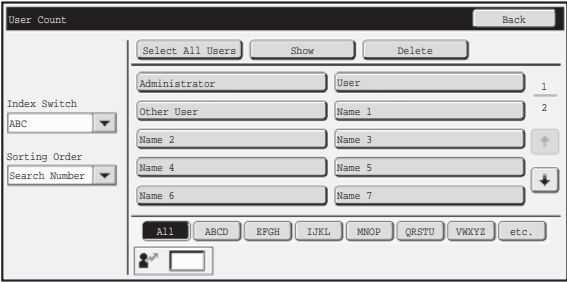

- **[Select All Users] key**  
This selects all users.
- **[Show] key**  
This shows the counts of the selected user.
- **[Delete] key**  
Use this to reset the counts of the selected user.

- **User List**  
This shows the factory-stored users and the currently stored users. To select a user, select the user name.

## Showing user count

Select a user in the above screen and touch the [Show] key. The counts of that user will appear.

Item	Settings
Next	This shows the next user (in the order of the registration numbers).
Previous	This shows the previous user (in the order of the registration numbers).
Show Counts	The counts and the number of pages remaining of the selected user are shown by function.
Page Limit	The page limit set for the user appears in parentheses below the count.

- Counts of devices that are not installed do not appear.
- A user count can be saved in the screen that appears when [User Control] - [User Count] - [Save User Count] is selected in the Web page menu.

## Resetting user counts

Select a user in the setting screen and touch the [Reset] key. A count reset screen for that user will appear. The reset screen will vary depending on whether a single user or multiple users were selected. The items displayed in each case are described in the table below.

### When a single user is selected

Item	Description
Next	This shows the next user (in the order of the registration numbers).
Previous	This shows the previous user (in the order of the registration numbers).
Show Counts	The counts and the number of pages remaining of the selected user are shown by function.
Clear Count	Reset the count of the selected item to "0".
Clear All Counts	Reset all items of the selected user to "0".

### When multiple users are selected

Item	Description
Show Counts	The counts and the number of pages remaining of the selected users are shown by function.
Clear Count	Reset the count of the selected item to "0".
Clear All Count	Reset all items of the selected users to "0".

## Card Settings (when the HID card reader is enabled.)

Configure this setting if user authentication will be performed using a Sharp OSA external authentication application and an HID card.

### Card Reader Device Registration

In this setting, the product ID and vender ID of the connected HID card reader are displayed. To store the HID card reader, touch the [Read] key.

\* For settings that enable an HID card to be used, consult your service technician.

# Energy Save

The Energy Save settings help reduce power costs. From an environmental perspective, these settings also help reduce pollution and conserve natural resources. Touch the [Energy Save] key to configure the settings.

## Toner Save Mode

You can reduce the amount of toner used for printing.

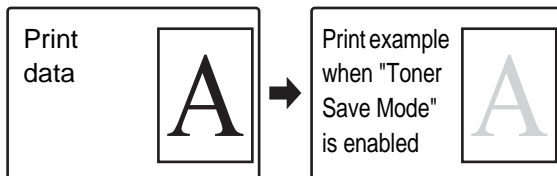

[Print] in Toner Save Mode is only effective when the machine's printer driver is not used. When the printer driver is used, the printer driver setting takes precedence.  
This function may not operate in some applications and operating systems.

## Auto Power Shut-Off

This setting enables or disables Auto Power Shut-Off. Remove the checkmark if you prefer that Auto Power Shut-Off does not operate.

When the set duration of time elapses after printing ends, Auto Power Shut-Off activates and causes the machine to go on standby at a minimal level of power consumption.

This function reduces your power costs, and at the same time helps conserve natural resources and reduce pollution.

If you prefer that auto power shut-off activates as little as possible, it is recommended that you try lengthening the time setting after which activation takes place rather than disabling the function altogether. (The time setting is changed using "[Auto Power Shut-Off Timer](#)".)

## Auto Power Shut-Off Timer

The time until Auto Power Shut-Off activates can be set to any number of minutes from 1 to 240.

Select the time that best suits your workplace needs.



The timer setting will not be effective if Auto Power Shut-Off is disabled using "[Auto Power Shut-Off](#)".

## Preheat Mode Setting

The time until Preheat Mode activates can be set to any number of minutes from 1 to 240.

Preheat Mode will activate when the set duration of time elapses after printing ends and no further operations are performed. This function reduces your power costs, and at the same time helps conserve natural resources and reduce pollution.

Select the time that best suits the needs of your workplace.



Preheat mode cannot be disabled.

# Operation Settings

Settings related to machine operation can be configured. Touch the [Operation Settings] key to configure the settings.

## Other Settings

### Keys Touch Sound

This setting is used to adjust (or turn off) the volume of the beep that sounds when you touch a key. You can also have three beeps sound at initial values when setting the ratio in copy mode or when adjusting the exposure in any mode.

Screen in which setting is effective	Initial value
Ratio setting screen in base screen of copy mode	Ratio 100%
Exposure adjustment screen in base screen of copy mode	Exposure level: 3 (medium)
Exposure adjustment screen in base screen of fax, Internet fax, and network scanner modes	
Exposure adjustment screen for Scan to HDD in document filing mode	

### Auto Clear Setting

The time until Auto Clear activates can be set to any number of seconds from 10 to 240.

If the machine is not used for the duration of time set here, the auto clear function will clear any settings that have been selected and return the screen to the base screen of copy mode or the job status screen.

#### Cancel Auto Clear Timer

This is used to disable the auto clear function.

### Message Time Setting

The duration of time that messages appear in the touch panel (the time until a message is automatically cleared) can be set to any number of seconds from 1 to 12.

### MFP Display Language Setting

The language that appears in the touch panel can be changed.



When user authentication is enabled and a display language is specified in the favorite operation group, that setting is given priority.

### Disabling of JJob Priority Operation

This disables the job priority function and hides the [Priority] key in the job status screen.

### Disabling of Bypass Printing

This is used to disable bypass printing (printing other jobs ahead of a job that has been stopped\* because the paper required for the job is not in any of the trays).

\* This does not include cases where the paper ran out during the job.

### Key Operation Setting

This setting determines how long a key in the touch panel must be touched until the key input is registered. The time can be set from 0 to 2 seconds in increments of 0.5 seconds.

By lengthening the time setting, key input can be prevented when a key is touched accidentally. Keep in mind, however, that when a longer setting is selected more care is required when touching keys to ensure that key input is registered.

#### Disable Auto Key Repeat

This is used to disable key repeat.

Key repeat causes a setting to change continuously while a key is touched, not only each time the key is touched.

### Disabling of Clock Adjustment

This setting is used to prohibit changing of the date and time.

### Business Card Scan Option

**MX-B402 Only**

When this setting is enabled, "Business Card Scan" can be used in the special modes for copying and scanning.

## Set Keyboard Priority

### MX-B402SC Only

When an external keyboard is connected, you can select whether the soft keyboard or the external keyboard is used.

## Initial Original Count Setting

### MX-B402SC Only

This specifies whether or not "Original Count" in the special functions is enabled for each function.

#### Copy

- Copy

#### Image Send

- Scan
- Internet Fax
- Fax Job
- Data Entry

#### Document Filing

- Scan to HDD

## MFP Display Pattern Setting

One of six color patterns can be selected for the color pattern in the touch panel. A sample of the selected pattern can be viewed.

## Customize Key Setting

Short-cuts to functions that are frequently used can be displayed in the base screen of each mode.

For information on customize keys, see the chapters for each function.

The settings are shown below.

Item	Description
Customized Keys 1 - 3	Enter a name for the customized key (maximum of 14 characters).
Item	Select the function that you want to assign to the key. The functions that can be selected vary by mode.
Return to the Defaults	This returns all customized keys to their factory default state.



This setting can only be configured in the Web pages. It cannot be configured in the touch panel of the machine.

## Home Screen Settings

Use this to configure the home screen that appears when the [HOME] key is pressed. The settings are shown below.

Item		Description
Mode Key	Key Name	When [custom] is selected, any key name (maximum of 16 characters) can be entered.
	Image	When [Use Custom Image] is selected, the Mode Key image can be changed using a gif file of up to 10 KB size.
Application Keys		A shortcut to the Sharp OSA application and keys that appear in "My Menu" can be stored (a total of eight keys can be stored).
Background Image		When [Use Custom Image] is selected, the background of the home screen can be changed using a 392 x 800 dot gif, png, jpg, or bmp file of up to 310 KB in size.



This setting can only be configured in the Web pages. It cannot be configured in the touch panel of the machine.

## My Menu Settings

Use this to configure the My Menu screen that appears when the [My Menu] key is pressed. The settings are shown below.

Item	Description
Display Title	Show a title on the My Menu.
Title	Enter a maximum of 70 characters for the title name.
Display the User Name*	Show the currently logged-in user name on the My Menu.
Display the Date and Time	Show the date and time on the My Menu.
Background Image	Select the image that appears in the background of the My Menu.
Design Template	A template for the design of the My Menu can be selected from the list. A sample of the selected template can be viewed.
Key Layout of the Screen	The layout of the keys in the My Menu is displayed.
Key Number	Select the number of the key that you want to configure, referring to "Screen Key Layout".
Key Name	The name of the key selected in "Key Number" can be changed (maximum of 48 characters).
Link Item	Specify the function that you want to use in the key selected in "Key Number".

\* Does not appear when user authentication is not enabled.



This setting can only be configured in the Web pages. It cannot be configured in the touch panel of the machine.

# Preview Setting

Configure settings for the preview screen that can be used for fax/image send and document filing.

## Default Preview

**MX-B402SC Only**

Set the selection state of the [Preview] key in each of the screens below.

### Copy

#### Image Send

- Scan Send
- Internet Fax Send
- Fax Send
- Data Entry
- USB Memory Scan

#### Document Filing

- Scan to HDD

## Default Preview Display

Select the display zoom ratio of the preview screen for copy\*, fax/image send and document filing.

\* MX-B402SC Only

## Received Data Image Check Setting

Select whether or not a preview of received faxes and Internet faxes is shown.

## Default List/Thumbnail Display

Select whether the default display format of the document filing file selection screen and the received fax list screen is list or thumbnails.

## Remote Operation Settings

Configure settings required for remote operation of the machine from a computer connected to the same network.

### Remote Software Operation

Operational Authority	This is used when remote software is used to operate the machine remotely.
View Password Entry Screen	When remote software is used to operate the machine remotely, the entry screen for the various passwords entered on the machine (such as login passwords) can be displayed on the machine, your computer, or both. This setting can be used to prevent the password from being seen.

### Operation from Specified PC

Operational Authority	This is used to allow remote operation of the machine using a specified computer.
Hostname or IP Address of PC	Enter the host name or IP address of the computer that will connect to the machine. A maximum of 127 characters can be entered.
View Password Entry Screen	When a specified computer is used to operate the machine remotely, the entry screen for the various passwords entered on the machine (such as login passwords) can be displayed on the machine, your computer, or both. This setting can be used to prevent the password from being seen.

### Operation by User who Has Password

Operational Authority	This is used to allow a user who has a password to operate the machine. For information on the password, consult your service technician.
View Password Entry Screen	When a user who has a password operates the machine remotely, the entry screen for the various passwords entered on the machine (such as login passwords) can be displayed on the machine, your computer, or both. This setting can be used to prevent the password from being seen.



# Device Control

These settings control devices installed on the machine. Touch the [Device Control] key to configure the settings.

## Other Settings

### AB/Inch Type Setting

The numbers and units of the default settings and input ranges that appear in the setting screens can be switched between inches and AB sizes.

### Default Original Size Settings

Specify this setting when a particular original size is frequently used. The setting will appear in the [Original] key. Specifying this setting allows the original size setting to be omitted.

Mode	Settings
Copy	None* <sup>1</sup> , A5, B5, A4, 216mm x 330mm (8-1/2" x 13"), 8-1/2" x 13-2/5" (216mm x 340mm), 216mm x 343mm (8-1/2" x 13-1/2"), 8-1/2" x 11", 8-1/2" x 14", 5-1/2" x 8-1/2", 16K, Check Size* <sup>2</sup> , Card Size* <sup>2</sup>
Image Send	None* <sup>1</sup> , A5, B5, A4, 216mm x 330mm (8-1/2" x 13"), 8-1/2" x 13-2/5" (216mm x 340mm), 216mm x 343mm (8-1/2" x 13-1/2"), 8-1/2" x 11", 8-1/2" x 14", 5-1/2" x 8-1/2", 16K, Check Size* <sup>2</sup> , Long Size
Scan to HDD	None* <sup>1</sup> , A5, B5, A4, 216mm x 330mm (8-1/2" x 13"), 8-1/2" x 13-2/5" (216mm x 340mm), 216mm x 343mm (8-1/2" x 13-1/2"), 8-1/2" x 11", 8-1/2" x 14", 5-1/2" x 8-1/2", 16K, Check Size* <sup>2</sup> , Card Size* <sup>2</sup> , Long Size

\*<sup>1</sup>When [None] is selected, the original size does not appear and must always be set manually.

\*<sup>2</sup>"Check Size" and "Card Size" are only for MX-B402SC.

### Setting of Default Original Exit Place

#### MX-B402SC Only

When the automatic document feeder is used, the original's\* default output destination can be set to the upper exit or the heavy exit.

\* Except when "Size Input" or "Card Size" is selected for the original size.

### Original Feeding Mode

The following original feeding modes can be set to operate by default in copy, Scan to HDD, and image send modes. When a mode is frequently used, this saves you from having to select the mode in the special modes each time you need to use it.

- Mixed Size Original (Same Width (Copy mode only))
- Slow Scan Mode
- Blank Page Skip (image send\* when using MX-B402SC)

\* Excluding fax mode and Internet fax mode.

### Auto Paper Selection Setting

The paper types\* that the Auto Paper Selection function will select can be specified. Select one of the following settings:

- Plain Paper
- Plain and Recycle Paper
- Recycle Paper

The Auto Paper Selection function will not select any paper types other than the paper types specified with this setting.

\* The paper type set for each paper tray using "Paper Tray Settings" (page 7-14) in the system settings (general).

### Detect Standard in Auto Color Mode

When the color mode is set to auto in image send mode, the discrimination point for detecting whether originals are color or black and white can be set to one of 5 levels. To make it easier to detect a black and white original, adjust the setting toward [(Closer B/W)]. To make it easier to detect a color original, adjust the setting toward [(Closer color)].

---

## Optimization of a Hard Disk

This function optimizes the hard drive of the machine by defragmenting data. If a job is in progress, a message will appear and optimization will not begin until the job is finished. During optimization, the following operations are not possible:

- Web page access, reception of print data
- Use of keys on the operation panel
- Turning off the power with the main power switch of the machine.
- Auto Power Shut-Off

When optimization is completed, the machine will automatically restart.



When the document filing function is frequently used and output of files seems somewhat slow, optimizing the hard drive may improve performance.

---

## Clear All Job Log Data

This is used to clear the entire job log. (There is normally no need to use this function.)

A log file is kept of jobs run on the machine. The job log can be used to check general use of the machine. The job log can be written to a computer in CSV format using a Web browser.

## Disabling of Devices

Use these settings when a peripheral device on the machine has failed or when you wish to temporarily disable a device.

---

### Disabling of Document Feeder

Use this setting to prohibit the use of the automatic document feeder, such as when the feeder malfunctions. (When the setting is enabled, scanning is still possible using the document glass.)

---

### Disabling of Duplex

This is used to disable two-sided printing, such as when the duplex module malfunctions.

---

### Disabling of Optional Paper Feed Unit

(When a 500-sheet paper feed unit is installed.)

This setting is used to disable a 500-sheet paper feed unit, such as when it malfunctions.

---

### Disabling of Tray Settings

This setting is used to prohibit tray settings (except for the bypass tray).

## Fusing Control Settings

These are used to control the toner fusing temperature according to the weight of the paper.

These settings apply to plain paper, recycled paper, punched paper, pre-printed paper, letterhead paper, colored paper, and user type paper.

You can select "16 to 23 lbs." or "23+ to 28 lbs." ("60g/m<sup>2</sup> to 89g/m<sup>2</sup>" or "90g/m<sup>2</sup> to 105g/m<sup>2</sup>").



- Be sure to use only paper that is in the same weight range as the weight range set here. Do not mix plain or other paper that is outside the range with the paper in the tray.
- When settings are changed, the changes will take effect after the machine is restarted. To restart the machine see "[TURNING THE POWER ON AND OFF](#)" (page 1-15) in "1. BEFORE USING THE MACHINE".

# Copy Function Settings

The following settings are related to copying. Touch the [Copy Function Settings] key to configure the settings. Default settings selected with these settings apply to all functions of the machine (not just the copy function).

## Initial Status Settings

The copier settings are reset when the [POWER] key (⏻) is turned on, when the [CLEAR ALL] key (Ⓢ) is pressed, or when the auto clear interval has elapsed. These settings are used to change the default settings for copy mode.

The following settings can be changed:

Item	Description
Paper Tray	Specify the paper tray that is selected by default.
Exposure Type	Configure exposure mode settings.
Copy Ratio	Specify the copy ratio that is selected by default.
2-Sided Copy	Configure the 2-sided mode settings that are selected by default. If this setting is used to change the default setting for the duplex function to other than "1-Side to 1-Side" and the duplex function or automatic document feeder fails or is disabled, the setting will revert to "1-Side to 1-Side".
Output	Set the print output method that is selected by default.
Return to the Defaults	This returns all items to the factory default settings.

## Other Settings

---

### Copy Exposure Adjustment

This is used to adjust the exposure level when [Auto] is used for the copy exposure.

Select separate settings for the document glass and for the automatic document feeder.

---

### Add or Change Extra Preset Ratios

Two enlargement preset ratios (101% to 200%) and two reduction preset ratios (50% to 99%) can be added. An added preset ratio can also be changed.



Preset ratios other than added preset ratios cannot be changed.

---

### Setting a Maximum Number of Copies

This is used to set the maximum number that can be entered for the number of copies (number of continuous copies). Any number from 1 to 999 can be specified.

---

### Initial Margin Shift Setting

This is used to set the default margin shift amount. Specify a value from 0" (0 mm) to 1" (20 mm) in increments of 1/8" (1 mm) for both the front and reverse sides.

---

### Erase Width Adjustment

This is used to set the default erase width for erase copy. Specify a value from 0" (0 mm) to 1" (20 mm) in increments of 1/8" (1 mm) for edge erase.

---

### Card Shot Settings

This is used to set the default original size for the card shot function.

Both the X (horizontal) and Y (vertical) dimensions of the original can be set from 1" (25 mm) to 8-1/2" (210 mm) in increments of 1/8" (1 mm).

#### Fit to Page

Enable this setting to have the [Fit to Page] key always appear in the card shot screen.

---

### Disabling Deletion of Job Programs

This is used to prohibit the deletion and changing of copy settings stored in job programs.

---

### Disabling of Bypass-Tray in Duplex Copy

This is used to prohibit the use of the bypass tray when making two-sided copies.

The bypass tray is often used to feed label sheets, transparency film, and other special media for which two-sided copying is prohibited. If a sheet of one of these special media enters the reversing unit, a misfeed or damage to the unit may result. If special media for which two-sided copying is prohibited is often used, it is recommended that you enable this setting.

---

### Disabling of Auto Paper Selection

This setting is used to disable the Auto Paper Selection function.

When this is enabled and an original size is set, the same size of paper is not automatically selected.

---

## Auto Selection of Paper Tray that was Last Loaded

When this setting is enabled and the machine is on standby in copy mode, the last paper tray that was loaded with paper automatically becomes the default paper tray for copy mode, until the machine is reset.

---

## 600dpi x 600dpi Scanning Mode for Document Feeder

This is used to change the scanning resolution for copying using the automatic document feeder from 600 x 300 dpi to 600 x 600 dpi (high quality mode).

When high quality mode is used, fine print and thin lines are reproduced with greater clarity, however, the scanning speed is slower.



When high quality mode is not selected, the following conditions must be satisfied in order to scan at 600 x 300 dpi and attain the fastest speed.

- The copy ratio must be set to 100%.
- Do not select a special mode that will change the ratio.

---

## Quick Scan from Document Glass

This is used to change the scanning resolution for copying using the document glass from 600 x 600 dpi to 600 x 300 dpi (speed priority mode).

When high speed mode is selected, the first copy time is quicker, however, the copy image is not as clear.



When high speed mode is selected, the following conditions must be satisfied in order to scan at 600 x 300 dpi and attain the fastest speed.

- The copy ratio must be set to 100%.
- Do not select a special mode that will change the ratio.

# Network Settings

Network settings are described below. Touch the [Network Settings] key to configure the settings.



When settings are changed, the changes will take effect after the machine is restarted. To restart the machine see "TURNING THE POWER ON AND OFF" (page 1-15) in "1. BEFORE USING THE MACHINE".

## IPv4 Settings

When using the machine on a TCP/IP (IPv4) network, use this setting to configure the IP address of the machine. The settings are shown below.

### IP Address

Enter the IP address of the machine.

### IP Subnet Mask

Enter the IP Subnet Mask.

### IP Gateway

Enter the IP Gateway address.

### DHCP

Use this setting to have the IP address obtained automatically using DHCP (Dynamic Host Configuration Protocol). When this setting is enabled, it is not necessary to manually enter an IP address.



- If the machine will be used on a TCP/IP network, be sure to enable "Enable TCP/IP" below.
- If DHCP is used, the IP address assigned to the machine may change automatically. If the IP address changes, specify the printer port setting again and then print.

## IPv6 Settings

When using the machine on a TCP/IP (IPv6) network, use this setting to configure the IP address of the machine. The settings are shown below.

### Enable IPv6 Protocol

Enable this setting.

### DHCPv6

Use this setting to have the IP address obtained automatically using DHCP (Dynamic Host Configuration Protocol). When this setting is enabled, it is not necessary to manually enter an IP address.

### Manual Address

Enter the IP address of the machine.

### Prefix Length

Enter the prefix length (0 to 128).

### Default Gateway

Enter the IP Gateway address.



- If the machine will be used on a TCP/IP network, be sure to enable "Enable TCP/IP" below.
- If DHCP is used, the IP address assigned to the machine may change automatically. If the IP address changes, specify the printer port setting again and then print.
- In an IPv6 environment, the machine can use LPD or IPP protocol.

## Enable TCP/IP

To use the machine on a TCP/IP network, this setting must be enabled.

## Enable NetWare

To use the machine on a NetWare network, this setting must be enabled.

## Enable EtherTalk

To use the machine on an EtherTalk network, this setting must be enabled.

## Enable NetBEUI

To use the machine on a NetBEUI network, this setting must be enabled.

## Reset the NIC

This returns all "Network Settings" to the factory default settings.

## Ping Command

Use this function to check if the machine can communicate with a computer on the network. Specify the IP address of the desired computer and touch the [Execute] key. A message will appear indicating whether or not the computer responded.

---

---

# Printer Settings

Settings related to the printer function can be configured. Touch the [Printer Settings] key to configure the settings.

## Default Settings

Printer condition settings are described below.

---

### Prohibit Notice Page Printing

This setting is used to disable printing of notice pages. A notice page is printed when printing cannot be executed as specified due to insufficient memory or other reason. The notice page indicates the reason.

---

### Prohibit Test Page Printing

This setting is used to disable printing of test pages. When this setting is enabled, "Printer Test Page" in the system settings cannot be used to print test pages.

---

### A4/Letter Size Auto Change

When printing an A4 size image, this setting allows letter (8-1/2" x 11") size paper to be used if A4 size paper is not loaded.

---

### Print Density Level

This lightens or darkens the print density of images. The print density can be adjusted to five levels.

---

### Bypass Tray Settings

#### Enable Detected Paper Size in Bypass Tray

This is used to prohibit printing when the paper size specified for a print job is different from the paper size inserted in the bypass tray.

#### Enable Selected Paper Type in Bypass Tray

This is used to prohibit printing when the paper type specified for a print job is different from the paper type inserted in the bypass tray.

#### Exclude Bypass-Tray from Auto Paper Select

When [auto] is selected for paper type selection, the bypass tray can be excluded from the trays that can be selected. This is recommended when special media is often placed in the bypass tray.

---

### Job Spool Queuing

When this function is enabled, received print jobs are displayed in the spool queue of the job status screen. The jobs are moved to the job queue after they have been analyzed by the machine. Multiple jobs that have not yet been analyzed can appear in the spool queue. When this function is disabled, received print jobs are displayed in the job queue without being displayed in the spool queue. However, when an encrypted PDF job is printed, the job appears in the spool queue.





# Image Send Settings

Settings related to the image send function (scan, Internet fax, etc.) can be configured. Touch the [Image Send Settings] key to configure the settings.



For explanations of settings related to the fax function, see "SYSTEM SETTINGS FOR FAX" (page 7-101).

## Operation Settings

The operation settings below apply to all image send functions.

### Other Settings

#### Default Display Settings

You can select one of 5 base screen types for the base screen that appears when the [IMAGE SEND] key is touched or when the [CLEAR ALL] (CA) key is pressed in image send mode.

- Address Book
- Scan
- Internet Fax
- Fax
- Data Entry

#### Hold settings for a while after scanning has been completed

Use this setting to hold the settings after scanning is completed (until Auto Clear Mode activates).

#### Switch Automatically to Copy Mode Screen

Enable this setting to have the screen automatically switch to the copy mode screen if no action is taken in the image send mode screen for 20 seconds.

#### Address Book Default Selection

One of the following screens can be specified for the initial address book screen.

##### Tab Switch

- ABC
- Group

##### Address Type

- All
- E-mail
- FTP/Desktop
- Network Folder
- Internet Fax (Including Direct SMTP)
- Fax
- Group

#### Initial Resolution Setting

The following settings are available for the default resolutions of scan, Internet fax, and fax mode.

Scan : 100X100 dpi, 200X200 dpi, 300X300 dpi, 400X400 dpi, 600X600 dpi

Internet fax : 200X100 dpi

200X200 dpi

200X400 dpi

400X400 dpi

600X600 dpi

Half Tone

Fax: Standard

Fine

Super Fine

Ultra Fine

Half Tone

#### Apply the Resolution Set when Stored

When an image stored by document filing is used, this applies the resolution setting that was stored with the image.

#### Default Exposure Settings

This is used to set the default exposure settings for scanning a document in image send mode. Select [Auto] or [Manual]. When [Manual] is selected, the exposure can be set to one of 5 levels.

#### Default Original Image Type

Select the original type beforehand to enable transmission at a resolution suitable for the original (only in scan mode and USB memory mode).

The settings are shown below.

- Text/Printed Photo
- Text/Photo
- Text
- Photo
- Printed Photo
- Map



When the exposure is set to [Auto], a default original type cannot be selected.

#### Moiré Reduction

This reduces the moiré effect (line pattern) that occurs when printed matter is scanned (only in scan mode and USB memory mode).

## Must Input Next Address Key at Broadcast Setting

This setting is used to require that the [Next Address] key be touched before the next address is entered when performing a broadcast transmission.

When this setting is enabled, the [Next Address] key cannot be omitted even if the next address is entered with a one-touch key.

If a user attempts to enter the next address without touching the [Next Address] key, a double-beep alarm will sound and the entry will be rejected.

## Scan Complete Sound Setting

The scan complete sound can be selected.

## The Number of File Name/Subject/Body Keys Displayed Setting

Select 6, 12 or 18 for the number of file name/subject keys that are displayed in the screen.

## The Number of Direct Address Keys Displayed Setting

Select 5, 10, or 15 for the number of one-touch keys that appear in the address book screen.

## Disable Switching of Display Order

This is used to prohibit changes to the order of display (search number order, ascending, descending) in the address book.

When this setting enabled, touching a tab on the address book screen does not change the order. The display order will remain fixed at the order that is in effect when this setting is enabled.

## Hold Setting for Received Data Print

**(When the Internet fax expansion kit or facsimile expansion kit is installed.)**

This function holds received faxes and Internet faxes in memory without printing them. The faxes can be printed by entering a password (factory default setting: 0000) with the numeric keys.

### Password

When [Hold Setting for Received Data Print] is enabled, enter the password (4-digit number).



These settings can only be configured when there is no received data in the machine's memory (excluding data in a confidential or relay broadcast memory box).

## Erase Width Adjustment

This is used to set the default erase width for erase function. Specify a value from 0" (0 mm) to 1" (20 mm) in increments of 1/8" (1 mm) for edge erase.

## Settings to Disable Registration

This is used to prohibit the storing of destinations. Storing from the machine, storing from the Web page, and storing from a computer can each be separately prohibited.

## Disable Registering Destination from Operation Panel

This disables address control from the machine. Configure the setting for each of the following items:

- Group (Direct Entry)
- Group (Address Book)
- Individual

Select All: Select all items.

Clear Checked: Clear all selections.

## Disable Registering Destination on Web Page

**(When network connection is enabled.)**

This disables address control from the Web pages. Configure the setting for each of the following items:

- Group (Direct Entry)
- Group (Address Book)
- Individual

Select All: Select all items.

Clear Checked: Clear all selections.

---

## Disable Registration of Program

This prohibits the use of the address book when a program is stored.

Configure the setting for each of the following items:

- E-mail
- FTP
- Desktop
- Network Folder
- Internet Fax (Including Direct SMTP)
- Fax

Select All: Select all items.

Clear Checked: Clear all selections.

---

## Disable Registration of Memory Box

Disable all types of memory box registration.

Configure the setting for each of the following items:

- Polling Memory
- Confidential
- Relay Broadcast (Direct Entry)
- Relay Broadcast (Address Book)

Select All: Select all items.

Clear Checked: Clear all selections.

---

## Disable Destination Registration Using Global Address Search

(When network connection is enabled.)

This disables address control from the global address search.

Configure the setting for each of the following items:

- E-mail
- Internet Fax
- Fax

Select All: Select all items.

Clear Checked: Clear all selections.

---

## Disable Registration Using Network Scanner Tool

(When network connection is enabled.)

This disables address control from the Network Scanner Tool.

---

## Settings to Disable Transmission

These settings are used to disable the following transmission operations.

---

### Disable [Resend] on Image Send Mode

This setting disables the [Resend] key in the base screen of image send mode.

---

### Disable Selection From Address Book

This disables the selection of destinations from the Address Book.

Configure the setting for each of the following items:

- E-mail
- FTP
- Desktop
- Network Folder
- Internet Fax (Including Direct SMTP)
- Fax

Select All: Select all items.

Clear Checked: Clear all selections.

---

### Disable Direct Entry

This prohibits the direct entry of addresses.

Configure the setting for each of the following items:

- E-mail
- Internet Fax (Including Direct SMTP)
- Fax

Select All: Select all items.

Clear Checked: Clear all selections.

---

### Disable PC-I-Fax Transmission

(When the Internet fax expansion kit is installed.)

This prohibits PC-I-Fax transmission.

---

### Disable PC-Fax Transmission

(When facsimile expansion kit is installed.)

This prohibits PC-Fax transmission.

---

## Own Name and Destination Set

Use this setting to enter the Internet fax address, fax number of the machine and the name of the user.

---

### Sender Data Registration

Use this to store the sender name for fax and Internet fax, the sender number for fax, and the sender address for Internet fax.

The stored sender name and fax sender number or Internet sender address will be printed at the top of the received fax.

#### Sender Name

Enter the sender name. A maximum of 20 characters can be entered for the sender name.

#### Sender Fax Number

This is used to set the sender fax number.

To insert a pause between digits of the number, touch the [-] key.

To insert a space between digits of the number, touch the [Space] key.

#### I-Fax Own Address

Enter a default sender address (maximum of 56 characters).

---

### Registration of Own Name Select

Store sender names used in "Own Name Select" in the special modes. Up to 18 sender names can be stored.

#### Add New

Store a sender name. A maximum of 20 characters can be stored.

After entering a sender name, touch the [Store] key. The lowest unused registration number from 01 to 18 will be automatically assigned to the sender name. This number cannot be changed.

#### Sender Name List

This shows a list of the stored sender names.

A sender name can be selected to delete it.

# Scan Settings

Settings related to scanning can be configured.

## Other Settings

### Default Sender Set

The information stored here is used if you do not specify [Reply-To] in the send settings when performing Scan to E-mail.

#### Sender Name

Enter a default sender name (maximum of 20 characters).

#### Reply E-mail Address

Enter a default reply address (maximum of 64 characters).



If only the sender name is stored, it will not be used as sender information.

### Default Color Mode Settings

Select a default color mode setting in scan mode. The settings are shown below.

- Auto (Mono 2, Grayscale\*)
- Full Color
- Grayscale
- Mono 2

\* File format for saving black & white originals scanned using [Auto]

#### Disable Change of B/W Setting in Auto Mode

This prohibits black & white settings from the base screen when the color mode is set to Auto.

### Initial File Format Setting

This is used to set the default file format for Scan to E-mail and USB memory mode when the e-mail address is entered manually by touching the [Address Entry] key.

#### File Format

PDF, TIFF, JPEG (B/W:TIFF), Encrypt PDF, XPS

#### Black & White

Compression Mode: None, MH(G3), MMR(G4)

#### Color/Grayscale

Compression Ratio: Low, Medium, High

#### Specified Pages per File

When multiple pages are scanned, this is used to generate a separate file for each scanned page (or specified number of pages).

When this setting is enabled, the number of pages per file can be specified.

#### Number of Pages

Any number of pages can be specified as the number of pages per file. This setting can be specified when [Specified Pages per File] is enabled.



When [JPEG] is selected for the file type, [Specified Pages per File] cannot be selected.

### Compression Mode at Broadcasting

This is used to set the compression mode for broadcasting using Scan to E-mail or Internet fax. The compression mode set here is used for all destinations regardless of their individual compression mode settings.

#### Black & White

MH(G3), MMR(G4)

#### Color/Grayscale

Low, Medium, High

## Maximum Size of E-mail Attachments (E-mail)

To prevent the transmission of excessively large image files by Scan to E-mail, a file size limit can be set from 1 MB to 10 MB in increments of 1 MB. If the total size of the image files created by scanning the original exceeds the limit, the image files are discarded.

If you do not wish to set a limit, select [Unlimited].



This setting is linked to "[Maximum Size of E-mail Attachments](#)" (page 7-85) in the Internet Fax Send Settings.

## Pre-Setting Mail Signature

A signature can be automatically appended to the end of the body text of e-mail. This is convenient when it is a corporate policy to append a specific signature at the end of e-mail.

The mail signature to be appended is configured in the Web pages. This setting simply enables or disables the signature.



This setting is linked to "[Pre-Setting Mail Signature](#)" (page 7-85) in the Internet Fax Initial Settings.

## Maximum Size of Data Attachments (FTP/Desktop/Network Folder)

A limit can be set for the size of files that can be sent by Scan to FTP, Scan to Desktop, and Scan to Network Folder. Limits that can be selected are 50 MB, 150 MB, and 300 MB. If the total size of the image files created by scanning the original exceeds the limit, the image files are discarded.

If you do not wish to set a limit, select [Unlimited].



When a broadcast transmission is performed that includes both e-mail and Internet fax destinations, the limit set in "[Maximum Size of E-mail Attachments \(E-mail\)](#)" (page 7-83) is given priority.

## Default Address Setting

A default address can be stored that makes it possible to transmit by simply pressing the [START] key without specifying an address.



- When this setting is enabled, the base screen changes to scan mode.
- Only a single default address can be set for Scan to E-mail, Scan to FTP, Scan to Desktop, and Scan to Network Folder.

## Bcc Setting

### Enable Bcc

Enable this setting if you wish to use Bcc delivery. When the setting is enabled, the [Bcc] key will appear in the image send address book screen.

### Display Bcc Address on the Job Status Screen

This displays Bcc addresses on the job status screen and address list tab.

## Disable Scan Function

This is used to disable PC scan and USB memory scan. When these modes are disabled, they are grayed out when the mode is changed in the base screen.



# I-Fax Settings



These settings can be configured when the Internet fax expansion kit is installed.

## I-Fax Default Settings

These settings are used to configure the default settings for Internet fax.

### Auto Wake Up Print

When the [POWER] key (⏻) is "off" (but the main power switch is "on") and an Internet fax is received, this function activates the machine and prints the fax. When this function is disabled, received Internet faxes are not printed until the [POWER] key (⏻) is switched "on".

### Compression Setting

This is used to set the default compression mode for Internet fax transmission.

The settings are shown below.

- MH (G3)
- MMR (G4)

### Speaker Volume Setting

This is used to adjust the volume of fax receive signals and communication error signals heard through the speaker.

A fax receive signal sounds after the machine checks the mail server and retrieves received faxes. A communication error signal sounds when a delivery failed e-mail is received from the destination Internet fax machine.

### Original Print on Transaction Report

When a transaction report is printed, this is used to print part of the first page of the transmitted original on the transaction report. Select one of the settings below.

- Print Out All Report
- Print Out Error Report Only
- No Printed Report

This setting will not be effective if "[Transaction Report Print Select Setting](#)" below is set to "No Printed Report".

### Transaction Report Print Select Setting

This is used to select whether or not a transaction report will be printed, and if printed, the condition for being printed. Select a setting for each of the following operations:

#### Single Sending

- Print Out All Report
- Print Out Error Report Only
- No Printed Report

#### Broadcasting

- Print Out All Report
- Print Out Error Report Only
- No Printed Report

#### Receiving

- Print Out All Report
- Print Out Error Report Only
- No Printed Report

When a transaction report is printed, you can have part of the first page of the transmitted original printed on the transaction report. For more information, see "[Original Print on Transaction Report](#)".



## Activity Report Print Select Setting

This is used to have the Image Sending Activity Report stored in the machine's memory automatically print at specified times.

The Image Sending Activity Report can be set to automatically print each time the number of transactions reaches 201, and it can also be set to automatically print at a specified time (once a day only). (The settings can be simultaneously enabled.)



- If you only enable the [Print Daily at Designated Time] setting  and the number of recorded transactions exceeds 201 before the specified time, each new transaction will delete the oldest transaction (the oldest transaction will not be printed).
- The Image Sending Activity Report can also be printed manually. See "[List Print \(Administrator\)](#)" (page 7-91) in the system settings (administrator).

## Body Text Print Select Setting

Image files attached to Internet faxes are normally printed. This setting can be enabled to also have the e-mail body text (subject and message) printed. This setting also applies to printing of the body text of e-mail messages without file attachments.



A maximum of 5 pages of body text can be printed.

## Pre-Setting Mail Signature

A signature can be automatically appended to the end of the body text of e-mail. This is convenient when it is a corporate policy to append a certain signature at the end of e-mail.

The mail signature to be appended is configured in the Web pages. This setting simply enables or disables the signature.



This setting is linked to "[Pre-Setting Mail Signature](#)" (page 7-83) in the Scan Settings.

## I-Fax Send Settings

I-Fax Send Settings are described below.

### I-Fax Reception Report On/Off Setting

This setting is used to request a reception report when an Internet fax is sent.

The reception report is returned to the sender address stored in "[Own Name and Destination Set](#)" (page 7-81).

### I-Fax Reception Report Request Timeout Setting

The duration of time that the machine will wait for a reception report from the destination machine can be set by any number from 1 minute to 240 hours in increments of 1 minute.



This setting is only effective when "[I-Fax Reception Report On/Off Setting](#)" is enabled.

### Number of Resend Times at Reception Error

The number of resend attempts when an error message is received from an I-Fax recipient can be set to any number from 0 to 15.



This setting is only effective when "[I-Fax Reception Report On/Off Setting](#)" is enabled.

### Maximum Size of E-mail Attachments

To prevent the transmission of excessively large image files by Internet fax, a file size limit can be set from 1 MB to 10 MB in increments of 1 MB. If the total size of the image files created by scanning the original exceeds the limit, the image files are discarded.

If you do not wish to set a limit, select [Unlimited].



- This setting is linked to "[Maximum Size of E-mail Attachments \(E-mail\)](#)" (page 7-83) in the Scan Settings.
- This setting does not apply to the limit for direct SMTP transmission.

## Rotation Sending Setting

When transmitting an image that is one of the following sizes, this function rotates the image counterclockwise 90 degrees. (The setting can be configured separately for each size.)

5-1/2" x 8-1/2", B5, A5

## Printing Page Number at Receiver

When the transmitted image is printed by the receiving machine, the page number can be added to the top of each printed page.

## Recall in Case of Line Busy

**(This setting is only effective for Direct SMTP transmission.)**

This program is used to set the number of recall attempts and the interval between recall attempts when a transmission is not successful due to the line being busy or other reason.

### Number of Times to Recall When Line is Busy

This setting specifies whether or not recalling is performed when the line is busy. When recalling is performed, you can set the number of recall attempts. Any number from 0 to 15 can be selected.

### Interval to Wait Between Recall Attempts (min.) When Line is Busy

The interval between recall attempts can be set. Any number of minutes from 1 to 15 can be selected.

## Recall in Case of Communication Error

**(This setting is only effective for Direct SMTP transmission.)**

This determines how many times your machine will automatically re-attempt the call if a fax transmission fails due to a communication error.

### Number of Times to Recall in Case of Error

Specify how many times the machine will re-attempt the call when a communication error occurs. Any number from 0 to 15 can be selected.

### Interval to Wait Between Recall Attempts (min.) in Case of Error

The interval between recall attempts can be set. Any number of minutes from 1 to 15 can be selected.

## I-Fax Receive Settings

I-Fax Receive Settings are described below.

## Auto Receive Reduce Setting

When a fax is received that includes printed information such as the sender's name and address, the received image is slightly larger than the standard size. This setting is used to automatically reduce the image to fit the standard size.



- If Auto Receive Reduce is disabled, the edges of the image outside the standard size will be cut off. However, the image will be clearer because it will be printed at the same size as the original.
- Standard sizes are sizes such as 8-1/2" x 11" and 8-1/2" x 5-1/2" (A4 and B5).

## Duplex Reception Setting

This is used to select whether or not received faxes are printed on both sides of the paper.

When this setting is enabled and a fax consisting of 2 or more pages is received (the pages must be the same size), the pages are printed on both sides of the paper.

## Set Address for Data Forwarding

When the machine is unable to print a received fax, the fax can be forwarded to another machine. This setting is used to configure the address of the other machine.

### Forwarding to

Enter the forwarding address (maximum of 64 characters).

### Direct SMTP

Select this to enable forwarding when direct SMTP is used.

### Add Hostname or IP Address.

Select this to separately enter a host name or IP address.

### Hostname or IP Address

When "Add Hostname or IP Address." is enabled, use this setting to enter the host name or IP address (maximum of 64 characters).



Multiple forwarding addresses cannot be stored.

## Receiving Date & Time Print

Enable this setting to have the date and time of reception printed.

Select [Inside the Received Image] or [Outside the Received Image] for the position where the date and time is printed.

When [Inside the Received Image] is selected, the date and time of reception is printed on the received image. When [Outside the Received Image] is selected, the received image is reduced and the date and time of reception is printed in the blank area that results.



[Outside the Received Image] cannot be selected for the reception date and time print setting when "Auto Receive Reduce Setting" (page 7-86) is not enabled.

## POP3 Communication Timeout Setting

The duration of time the machine waits until stopping reception when a response is not received from the mail server (POP3 server) can be set from 30 to 300 seconds in increments of 30 seconds.

## Reception Check Interval Setting

This is used to specify the interval at which the machine automatically checks the mail server (POP3 server) for received Internet faxes. The interval can be set from 0 minutes to 8 hours in increments of 1 minute.

When 0 hours 0 minutes is specified, the machine does not automatically check the mail server for received Internet faxes.



The machine also checks the mail server (POP3 server) for received Internet faxes when the main power is switched on. (Except when 0 hours 0 minutes is specified.)

## Allow/Reject Mail or Domain Name Setting

This setting is used to allow or refuse reception from specified addresses/domains.

Item	Description
Reject Reception	Reception from the stored address/domain is not allowed.
Allow Reception	Reception from the stored address/domain is allowed.
All Invalid	Reception from any address and domain is allowed, regardless of whether or not any addresses or domains have been stored.
Add New	Use this to add a new address or domain (maximum of 50) from which reception is to be rejected or allowed. Enter the address/domain (maximum of 64 characters) and touch the [Store] key. If the first character of the entry is not "@", the entry is identified as an address. If the first character is "@", the entry is identified as a domain. (xxx@xx.xxx.com is treated as an address, and @xx.xxx.com is treated as a domain.) Storing an address specifies only that address. Storing a domain specifies all addresses that include that domain.
Registered address or domain list	This shows a list of the stored addresses and domains. An address or domain can be selected in this screen to delete it from the list.



When there are no stored anti junk mail addresses or domains, only the [Add New] key can be selected.

# Document Filing Settings

Document filing settings are described below. Touch the [Document Filing Settings] key to configure the settings.

## Other Settings

### Default Mode Settings

This is used to specify which mode, Sharing or Confidential, is used as the default mode when storing a file.

When [Confidential Mode] is selected, the [Confidential] checkbox in the information screen for filing will be selected .

### Sort Method Setting

This setting is used to select the order in which of files stored in the Main Folder, Custom Folder, and Quick File Folder are displayed. Select one of the following settings:

- File Name
- User Name
- Date

### Administrator Authority Setting

For files and user folders that have a password, this setting allows the administrator password to be entered instead of the password when accessing the file or folder.

The administrator can also change the password.

### Delete All Quick Files

This function deletes all files except protected files from the Quick File Folder.

#### Delete Now

Touch this key to start deletion of all files immediately.

#### Delete Quick Files at Power Up

This is used to automatically delete all files in the Quick File Folder (with the exception of protected files) when the [POWER] key (⏻) is turned "on".

### Default Color Mode Settings

This sets the default color mode settings when Scan to HDD is used.

The settings are shown below.

- Auto
- Full Color
- Grayscale
- Mono 2

### Default Exposure Settings

Default exposure settings for document filing can be configured. Select [Auto] or [Manual]. If you select [Manual], set the exposure to one of 5 levels.

#### Default Original Type

Select the original type beforehand to enable scanning at a resolution suitable for the original.

The settings are shown below.

- Text/Printed Photo
- Text/Photo
- Text
- Photo
- Printed Photo
- Map



When the exposure is set to [Auto], a default original type cannot be selected.

#### Moiré Reduction

This reduces the moiré effect (line pattern) that occurs when printed matter is scanned.

### Initial Resolution Settings

One of the following resolutions can be selected for the default resolution for transmission.

- 100X100 dpi
- 200X200 dpi
- 300X300 dpi
- 400X400 dpi
- 600X600 dpi

---

## Scan Complete Sound Setting

This setting adjusts the volume of the beep that sounds when scanning ends. The beep can also be turned off.

---

## Disable Stamp for Reprinting

When a stored file is retrieved and printed, this setting prohibits the selection of a "Stamp" setting in the special modes. If a stamp setting is already selected, it will not be possible to change the stamp setting.

This function can be used to prevent inconsistencies in the printed information, such as that of the original date in the file and the date the file is retrieved and printed.

---

## Batch Print Settings

When printing files by batch printing, this setting is used to prohibit the selection of the [All Users] key and the [User Unknown] key in the user selection screen.

---

## Erase Width Adjustment

This is used to set the default erase width for erase function. Specify a value from 0" (0 mm) to 1" (20 mm) in increments of 1/8" (1 mm) for edge erase.

---

## Card Shot Settings

This is used to set the default original size for the card shot function.

Both the X (horizontal) and Y (vertical) dimensions of the original can be set from 1" (25 mm) to 8-1/2" (210 mm) in increments of 1/8" (1 mm).

### Fit to Store Size

Enable this setting to have the [Fit to Store Size] key always appear in the card shot screen.

## Document Output Options

The use of a stored file can be allowed or prohibited by operation type and by the mode from which the file was stored.



The items that appear will vary depending on the functions that have been added to the machine.

Item	Description
Print	For each mode, select whether or not printing of stored files is allowed.
Scan Send	For each mode, select whether or not scan send of stored files is allowed.
Internet Fax Send	For each mode, select whether or not I-Fax transmission of stored files is allowed.
Fax Send	For each mode, select whether or not fax transmission of stored files is allowed.

## Automatic Deletion of File Settings

Time and folder settings can be configured to have files in specified folders (stored by document filing) automatically deleted at a specified time. Up to 3 settings can be stored to be automatically deleted.

The procedure for using this function is as follows:

- (1) Select one of [Setting 1] to [Setting 3].
- (2) Set the time and date of automatic deletion.
- (3) Select the desired folder.
- (4) Specify whether or not protected files and confidential files are to be deleted.
- (5) Enable the stored settings.

Item	Description
Schedule	Select the automatic deletion cycle. <ul style="list-style-type: none"> <li>• Every Day: Auto deletion every day at the specified time.</li> <li>• Every Week: Auto deletion at the specified time on the specified day of the week.</li> <li>• Every Month: Auto deletion at the specified time on the specified day of the month.</li> </ul>
Folders	To select the folder separately, select [Folder Select] and select the desired folder. To select all folders, including the folder currently being created, select [All Folders (Including folders registered hereafter)].
Delete Protected File	Enable this setting to include protected files in the deletion.
Delete Confidential File	Enable this setting to include confidential files in the deletion.

### Delete Now

When this is executed with a folder selected, all files in the folder will be immediately deleted regardless of the date and time setting.

---

---

# List Print (Administrator)

This is used to print lists and reports that are only for use by the administrator of the machine. Touch the [List Print (Administrator)] key to configure the settings.

---

## Administrator Settings List

Lists of the administrator settings for the following modes can be printed.

- Copy
- Print
- Image Send
- Document Filing
- Security
- Common
- All Administrator Settings List

---

## Image Sending Activity Report

The following Image Sending Activity Reports can each be separately printed.

- Image Sending Activity Report (Scan)
- Image Sending Activity Report (Internet Fax)
- Image Sending Activity Report (Fax)

---

## Data Receive/Forward List

The following lists showing reception settings and forwarding settings can be printed.

- Anti Junk Fax Number List
- Anti Junk Mail/Domain Name List
- Inbound Routing List
- Document Admin List

---

## Web Settings List

**(When network connection is enabled.)**

This prints a list of the settings that are configured in the Web pages.

---

## Metadata Set List

**(When the application integration module is installed.)**

This prints a list of the metadata sets stored in the Web pages.



# Security Settings

The following settings are related to security. Touch the [Security Settings] key to configure the settings.

## SSL Settings

SSL can be used for data transmission over a network. SSL is a protocol that enables the encryption of information communicated over a network. Encrypting data makes it possible to transmit and receive sensitive information safely.

SSL can be enabled for the following protocols:

### Server Port

- **HTTPS:** Apply SSL encryption to HTTP communication.
- **IPP-SSL:** Apply SSL encryption to IPP communication.
- **Redirect HTTP to HTTPS in Device Web Page Access:**  
When this setting is enabled, all communication that attempts to access the machine by HTTP is redirected to HTTPS.

### Client Port

- **HTTPS:** Apply SSL encryption to HTTP communication.
- **FTPS:** Apply SSL encryption to FTP communication.
- **SMTP-SSL:** Apply SSL encryption to SMTP communication.
- **POP3-SSL:** Apply SSL encryption to POP3 communication.
- **LDAP-SSL:** Apply SSL encryption to LDAP communication.

### Level of Encryption

The encryption strength can be set to one of three levels.

## IPsec Settings

IPsec can be used for data transmission/reception on a network. When IPsec is used, data can be sent and received safely without the need to configure settings for IP packet encryption in a Web browser or other higher-level application.

This setting is only used to enable or disable IPsec; detailed IPsec settings are configured in the Web pages. Note the following points when enabling IPsec:

- A certain amount of time may be needed for the setting to be updated. During this time, it will not be possible to connect to the machine.
- If the settings in the Web page are not configured correctly, it will not be possible to connect to the machine, and printing, scanning, and Web page display may not be possible. In this event, disable the setting at the machine and then correct the settings in the Web page.



Detailed IPsec settings are configured in [IKEv1 Settings] and [IPsec Rules] in [Security Settings] > [IPsec Settings] in the Web page menu.

## IEEE802.1X Setting

IEEE802.1X can be used to authenticate a user to allow use of the machine.

IEEE802.1X protocol defines port-based authentication for both wired and wireless networks.

Use IEEE802.1X authentication to allow only authenticated devices to use network, and protect against network abuse by third parties.

This setting is only used to enable or disable IEEE802.1X; detailed IEEE802.1X settings are configured in the Web pages.

Some Web page settings may not allow connection to the machine, or the settings may not allow printing, scanning, or Web page display. In this case, deselect this setting and change the Web page settings.



Advanced IEEE802.1X settings are configured by clicking [Security Settings] and then [IEEE802.1X Settings] in the Web page menu.



# Enable/Disable Settings

The following settings are used to prohibit the use of certain functions. Touch the [Enable/Disable Settings] key to configure the settings.



The Enable/Disable Settings control the same parameters as the enable/disable settings in other settings. The settings are linked together (changing one setting changes the other).

## Printer Condition Settings

### Disable Blank Page Print

This setting is used to disable blank page printing.

## User Control

### Disabling of Printing by Invalid User

Printing by users whose information is not stored in the machine, such as printing without entering valid user information in the printer driver or printing of a file on an FTP server from the Web pages, can be prohibited.

## Operation Settings

### Cancel Auto Clear Timer

This setting is used to disable Auto Clear.

### Disabling of Job Priority Operation

The job priority function can be disabled. When this is done, the [Priority] key will not appear in the job status screen.

### Disabling of Bypass Printing

This setting is used to disable bypass printing (printing other jobs ahead of a job that has been stopped\* because the paper required for the job is not in any of the trays).

\* This does not include cases where the paper ran out during the job.

### Disable Auto Key Repeat

This setting is used to disable the auto key repeat function.

### Disabling of Clock Adjustment

This setting is used to prohibit changing of the date and time.

## Device Control

### Disabling of Document Feeder

Use this setting to prohibit the use of the automatic document feeder, such as when the feeder malfunctions. (When the setting is enabled, scanning is still possible using the document glass.)

### Disabling of Duplex

This is used to disable two-sided printing, such as when the duplex module malfunctions.

### Disabling of Optional Paper Feed Unit

(When a 500-sheet paper feed unit is installed.)

This setting is used to disable a 500-sheet paper feed unit, such as when it malfunctions.

### Disabling of Tray Setting

This setting is used to prohibit tray settings.

### Disabling of Offset

(When a finisher is installed.)

This setting is used to disable the offset function.

### Disabling of Stapler

(When a finisher is installed.)

This setting is used to prohibit stapling, such as when the stapler unit of the finisher malfunctions.

---

## Copy Function Settings

### Disabling Deletion of Job Programs

This is used to prohibit the deletion and changing of copy settings stored in job programs.

### Disabling of Bypass-Tray in Duplex Copy

This is used to prohibit the use of the bypass tray when making two-sided copies.

The bypass tray is often used to feed label sheets, transparency film, and other special media for which two-sided copying is prohibited. If a sheet of one of these special media enters the reversing unit, a misfeed or damage to the unit may result. If special media for which two-sided copying is prohibited is often used, it is recommended that you enable this setting.

### Disabling of Auto Paper Selection

This setting is used to disable the Auto Paper Selection function.

When this setting is enabled, automatic selection of paper that is the same size as the original on the document glass or in the automatic document feeder does not take place.

---

## Printer Settings

### Prohibit Notice Page Printing

This setting is used to disable printing of notice pages.

### Prohibit Test Page Printing

This setting is used to disable printing of test pages.

When this setting is enabled, "Printer Test Page" in the system settings cannot be used to print test pages.

### Exclude Bypass-Tray from Auto Paper Select

When [Auto] is selected for paper type selection, the bypass tray can be excluded from the trays that can be selected. This is recommended when special paper is often placed in the bypass tray.

---

## Image Send Settings

### Other Disabling

#### Disable Switching of Display Order

This is used to prohibit changes to the order of display (search number order, ascending, descending) in the address book.

When this setting is enabled, touching a tab on the address book screen does not change the order. The currently selected display order will be the order that is used after the setting is selected.

#### Disable Scan Function

This is used to disable PC scan and USB memory scan. When these modes are disabled, they are grayed out when the mode is changed in the base screen.

### Settings to Disable Registration

#### Disable Registering Destination from Operation Panel

This disables address control from the machine.

Configure the setting for each of the following items:

- Group (Direct Entry)
- Group (Address Book)
- Individual

Select All: Select all items.

Clear Checked: Clear all selections.

**Disable Registering Destination on Web Page**

(When network connection is enabled.)

This disables address control from the Web pages.

- Group (Direct Entry)
- Group (Address Book)
- Individual

Select All: Select all items.

Clear Checked: Clear all selections.

**Disable Registration of Program**

This prohibits the use of the address book when a program is stored.

Configure the setting for each of the following items:

- E-mail
- FTP
- Desktop
- Network Folder
- Internet Fax (Including Direct SMTP)
- Fax

Select All: Select all items.

Clear Checked: Clear all selections.

**Disable Registration of Memory Box**

Disable all types of memory box registration.

Configure the setting for each of the following items:

- Polling Memory
- Confidential
- Relay Broadcast (Direct Entry)
- Relay Broadcast (Address Book)

Select All: Select all items.

Clear Checked: Clear all selections.

**Disable Destination Registration Using Global Address Search**

(When network connection is enabled.)

This disables address control from the global address search.

Configure the setting for each of the following items:

- E-mail
- Internet Fax
- Fax

Select All: Select all items.

Clear Checked: Clear all selections.

**Disable Registration Using Network Scanner Tools**

(When network connection is enabled.)

This disables address control from the Network Scanner Tool.

**Settings to Disable Transmission**

These settings are used to disable the following transmission operations.

**Disable [Resend] on Image Send Mode**

This setting disables the [Resend] key in the base screen of image send mode.

**Disable Selection from Address Book**

This disables the selection of destinations from the address book.

Configure the setting for each of the following items:

- E-mail
- FTP
- Desktop
- Network Folder
- Internet Fax (Including Direct SMTP)
- Fax

Select All: Select all items.

Clear Checked: Clear all selections.

**Disable Direct Entry**

This prohibits the direct entry of addresses.

Configure the setting for each of the following items:

- E-mail
- Internet Fax (Including Direct SMTP)
- Fax

Select All: Select all items.

Clear Checked: Clear all selections.

**Disable PC-I-Fax Transmission**

(When the Internet fax expansion kit is installed.)

This prohibits PC-I-Fax transmission.

**Disable PC-Fax Transmission**

(When the facsimile expansion kit is installed.)

This prohibits PC-Fax transmission.

---

**Document Filing Settings****Disable Stamp for Reprinting**

When a stored file is retrieved and printed, this setting prohibits the selection of a "Stamp" setting in the special modes. If a stamp setting is already selected, it will not be possible to change the stamp setting.

This function can be used to prevent inconsistencies in the printed information, such as that of the original date in the file and the date the file is retrieved and printed.

**Batch Print Settings**

When printing files by batch printing, this setting is used to prohibit the selection of the [All Users] key and the [User Unknown] key in the user selection screen.

---

---

# Change Administrator Password

This is used to change the administrator password. Touch the [Change Administrator Password] key to change the password.

When changing the password, be sure to remember the new password.  
It is recommended that you periodically change the administrator password.

**Password**

Enter the new administrator password (5 to 32 characters).

**Password (confirmation)**

Enter the new password once again for confirmation purposes.



For the factory default administrator password, see "TO THE ADMINISTRATOR OF THE MACHINE" in the Start Guide.

---

---

# Product Key

The procedures for entering the product keys of the expansion kits are explained below. Touch the [Product Key] key to configure the settings.



- It may not be possible to use some settings, depending on the peripheral devices installed.
- For the product key to be entered, contact your dealer.

---

## Serial Number

This displays the serial number that is required to obtain the product key.

---

## Internet Fax Expansion Kit

Enter the product key of the Internet fax expansion kit.

---

## E-mail Alert and Status

Enter the product key of e-mail alert and status.



When the fax function is enabled, this is displayed as "E-mail Status".

---

## Application Integration Module

Enter the product key of the application integration module.

---

## Application Communication Module

Enter the product key of the application communication module.

---

## External Account Module

Enter the product key of the external account module.

---

## XPS Expansion Kit

Enter the product key of the XPS expansion kit.

---



---

# Data Backup

Settings and information stored in the machine can be saved to USB memory.



- This function can be enabled when a USB memory device is installed.
- This function cannot be used while the system settings are in use, while a job is being executed, or when there is a reserved job.
- For machines for which data can be imported, contact your SHARP dealer or nearest SHARP Service Department.

---

## Storage Backup

Address book information and user information stored in the machine can be saved to and retrieved from USB memory.

### Export

This exports data to USB memory.

### Import

This imports data that was exported to USB memory using "Export" into the machine.

---

## Device Cloning

Device cloning is used to save the machine's setting information in XML format and copy the information to another machine.

This function saves you the trouble of repeatedly configuring the same settings in multiple machines.

### Export

This exports data to USB memory.

### Import

This imports data that was exported to USB memory using "Export" into the machine.



The following data is not copied when device cloning is performed:

- List print and fax forwarding items.
- Count and device status display items.
- IP address of the machine, device name, administrator password, sender names for image send, and other information that is specific to the machine.
- Screen contrast and other adjusted values particular to each hardware device.

---

---

# Storing/Calling of System Settings

The current system settings can be stored, previously stored system settings can be retrieved, and the factory default system settings can be restored. Touch the [Storing/Calling of System Settings] key to configure the settings.

---

## Restore Factory Defaults

This is used to return the system settings to the factory default settings. If you wish to create a record of the current settings before restoring the factory default settings, print the current settings using "[List Print \(Administrator\)](#)" (page 7-91) in the system settings (administrator).



When settings are changed, the changes will take effect after the machine is restarted. To restart the machine see "[TURNING THE POWER ON AND OFF](#)" (page 1-15) in "1. BEFORE USING THE MACHINE".

---

## Store Current Configuration

This is used to store the currently configured system settings. The stored settings will be retained even if the [POWER] key (⏻) is turned off. To retrieve the stored settings, use "[Restore Configuration](#)" below.

### Items not stored

- Network Settings: These are not stored as unexpected settings may cause damage to the network.
- Product Keys: Product Keys are not stored as reissue of keys may be necessary.

---

## Restore Configuration

Use this to restore settings stored with "[Store Current Configuration](#)".

The current settings will change to the retrieved settings.

# Sharp OSA Settings



These settings can be used when the external account module or application communication module is available.

## External Account Setting

### External Account Control

When this setting is enabled, the machine enters external totaling mode and the totaling function can be used via an external account application.

### Enable Authentication by External Server

When this setting is enabled, the machine enters external authentication mode. Access to the machine is controlled by an external application.



When settings are changed, the changes will take effect after the machine is restarted. To restart the machine see "[TURNING THE POWER ON AND OFF](#)" (page 1-15) in "1. BEFORE USING THE MACHINE".

## USB Driver Settings

When installing the external account module or application communication module, set the driver of the USB device to be connected.

Configure the settings below based on the specifications of your Sharp OSA application.

### External Keyboard

Select whether the internal or external driver for the external keyboard is used.

### USB Memory

Select whether the internal or external USB memory driver is used.

### Level of Encryption

Select the level of encryption for communication using the external driver.

Select from none or AES-128, AES-256.



- When the external driver is selected, it will not be possible to use a USB device in a mode other than Sharp OSA mode.
- When settings are changed, the changes will take effect after the machine is restarted. To restart the machine see "[TURNING THE POWER ON AND OFF](#)" (page 1-15) in "1. BEFORE USING THE MACHINE".

## Job Priority Preference

Set the playing speed of the animation in the Sharp OSA application.

The following settings can be configured.

- Printing
- Balanced
- LCD Animation Playback



When "LCD Animation Playback" or "Balanced" is selected, the machine's job processing speed (for print and other jobs) may become slower. If you wish to give priority to job processing speed, select "Printing".



# SYSTEM SETTINGS FOR FAX

This section explains system settings that are specifically for the fax function.

The system settings for the fax function can only be configured when the facsimile expansion kit is installed.

## System Settings for Fax (General) List

When the system settings for fax are accessed with general rights, the following items appear. For items that can only be accessed with administrator rights, see "[System Settings for Fax \(Administrator\) List](#)" (page 7-107).



Depending on the machine specifications and peripheral devices installed, it may not be possible to use some settings.

### Address Control

Item	Factory default setting	Page
■ <a href="#">Address Control</a>		7-102
● <a href="#">Address Book</a>	–	7-102
● <a href="#">F-Code Memory Box</a>	–	7-104

### Fax Data Receive/Forward

Item	Factory default setting	Page
■ <a href="#">Fax Data Receive/Forward</a>		7-106
● <a href="#">Fax Settings</a>		7-106
▶ <a href="#">Receive Setting</a>	Auto Reception	
▶ <a href="#">Multiple Set Print</a>	Disabled	
▶ <a href="#">Staple*</a>	Disabled	
▶ <a href="#">Forward Received Data</a>	–	

\* When a finisher is installed.

# Address Control

## Address Book

This section explains items specifically used for fax in "Address Control". For items that are also used for other functions, see "Address Control" (page 7-17).

When the [Address Book] key is touched, the following screen appears.

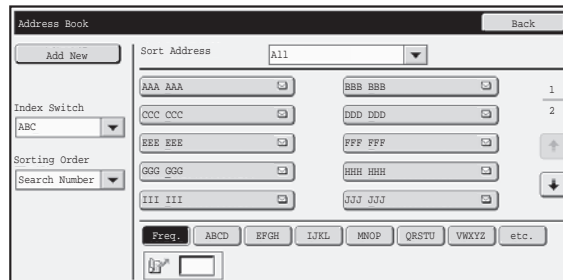

- **[Add New] key**

Use this to add a new address.

- **List display**

This displays a list of the currently stored addresses. An address can be selected to open an edit/delete screen for the address.

## Storing addresses

Touch the [Add New] key in the above screen to open a registration screen. Up to 999 addresses can be stored. For information on the settings, see "Settings" (page 7-103).



When "Disable Registering Destination from Operation Panel" (page 7-79) is enabled in the system settings (administrator) for a function, addresses cannot be stored for that function.

## Editing and deleting addresses

An address can be selected from the list in the above screen to open an edit/delete screen for the address. For information on the settings, see "Settings" (page 7-103).

Delete an address with the [Delete] key.



- **If you cannot edit or delete a one-touch individual or group key...**

Individual keys and group keys cannot be edited or deleted in the following situations:

- The key is used in a reserved transmission or a transmission in progress.
- The key is included in a group key.
- The key is included in a program.
- The key is specified as an end receiving machine in an F-code relay broadcast transmission.
- When "Disable Registering Destination from Operation Panel" (page 7-79) is enabled.

If the key is used in a reserved transmission or a transmission that is in progress, cancel the transmission or wait until it is completed and then edit or delete the key.

If the key is included in a group, first delete the key from the group and then edit or delete the key.

If the key is specified as a forwarding destination, cancel the forwarding destination setting and then edit or delete the key.

If "Disable Registering Destination from Operation Panel" has been enabled, clear this function and then edit or delete the key.

## Settings

Item	Description
<b>General items stored</b>	
Address Type	Select the type of address to be stored in the address book. In this case, select [Fax].
Search Number	Set a search number. The lowest available number is automatically entered. To change the number, enter a number from 001 to 999. A search number that has already been stored cannot be used.
Address Name	Enter a maximum of 36 characters for the address name.
Initial	Enter up to 10 characters for the initials. The initials you enter here determine the position of the one-touch key in the alphabetical index.
Key Name	Enter the name that you wish to appear in the address book (this is different from the address name).
Custom Index	Select the custom index in which the address will appear.
Register this Address to be added to the [Frequent Use] index.	Frequently used addresses can be stored in the [Frequent Use] index.
Fax Number	<p>Enter the fax number of the destination (maximum of 64 digits).</p> <p><b>Entering a pause between digits of the number</b> Touch the [-] key at the place where you wish to enter a pause.</p> <p><b>To enter an F-code (sub-address and passcode)...</b></p> <ol style="list-style-type: none"> <li>(1) Enter the destination fax number.</li> <li>(2) Touch the [/] key.</li> <li>(3) Enter the sub address (maximum of 20 digits).</li> <li>(4) Touch the [/] key.</li> <li>(5) Enter the passcode (maximum of 20 digits). A passcode is not necessary if the destination machine does not use a passcode.</li> </ol> <p>The destination fax number can be a maximum of 64 digits including all numbers and characters. However, only the first 32 digits will appear in the display.</p>
Transmission Mode	<p>Set the transmission speed and the International Correspondence Mode. Selecting appropriate settings for these items may help eliminate communication errors.</p> <p><b>Transmission Speed</b> 33.6 kbps, 14.4 kbps, 9.6 kbps or 4.8 kbps can be selected for the transmission speed. Higher numbers are higher transmission speeds. Set the transmission speed only when you know what speed is most suitable, such as when you are sending a fax to a foreign country and telephone line conditions are bad. If you do not know the line conditions, do not change this setting.</p> <p><b>Transmission Mode</b> No Sound, Mode1, Mode2, or Mode3 can be selected for the International Correspondence Mode. When sending a fax to a foreign country, telephone line conditions can sometimes distort the fax or interrupt the transmission. If errors frequently occur when sending a fax to a foreign country, try each of modes 1 to 3 and select the mode that enables the best transmission.</p>

## F-Code Memory Box

This section explains how to store memory boxes for various types of F-code communication. When the [F-Code Memory Box] key is touched, the following screen appears.

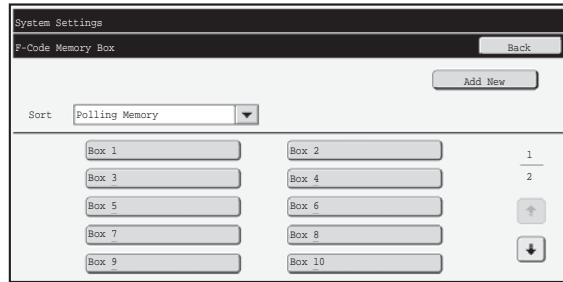

- **[Add New] key**

Use this to add a new memory box.

- **List display**

This displays a list of the currently stored memory boxes. A memory box can be selected to open an edit/delete screen for the memory box.

### Storing a memory box

Touch the [Add New] key in the above screen to open a registration screen. A total of 100 F-code memory boxes for all functions (polling memory, confidential, and relay broadcast) can be stored.

For information on the settings, see "[Settings](#)" (page 7-105).

### Editing and deleting a memory box

A memory box can be selected from the list in the above screen to open an edit/delete screen for the box.

For information on the settings, see "[Settings](#)" (page 7-105).

Delete a memory box with the [Delete] key.

## Settings

Item	Description
<b>Items common to all types</b>	
Box Type	<p>Select the type of box.</p> <ul style="list-style-type: none"> <li>• <b>Polling Memory:</b> Store a memory box for F-code polling memory. The sub-address and passcode that you program in the memory box are necessary for the other machine to poll your machine (request transmission) using F-code communication.</li> <li>• <b>Confidential:</b> Store a memory box for F-code confidential reception. In addition, store a "Print PIN" in the memory box to print faxes received by confidential reception. The sub-address and passcode that you program in the memory box are necessary for the other machine to send a fax to your machine by F-code confidential transmission.</li> <li>• <b>Relay Broadcast:</b> Store a memory box for F-code relay broadcast transmission. Store the fax numbers of the end recipients (up to 30) in the memory box. The sub-address and passcode that you program in the memory box are necessary for the other machine to perform an F-code relay request transmission (ask your machine to relay a fax).</li> </ul>
Memory Box Name	Enter a name (maximum of 18 characters) for the memory box.
Sub Address / Passcode	Enter a sub-address and passcode. A maximum of 20 digits can be entered for each. Separate a sub-address and passcode by a slash ("/").
<b>Items displayed when storing a confidential memory box</b>	
Print PIN	Set a "Print PIN" for confidential reception. Enter a 4-digit number.
<b>Items displayed when storing a relay broadcast memory box</b>	
Recipients	<p>Select the end recipients of the relay broadcast. Select the recipients from the address book.</p> <ul style="list-style-type: none"> <li>• <b>Direct Entry:</b> An address that is not stored in the address book can be directly entered. Enter the address in the same way as when storing an address for a mode.</li> <li>• <b>Address Review:</b> This displays a list of the selected recipients. Addresses can be deleted from this list if needed.</li> </ul>



- When programming a new memory box, a sub-address that is already programmed for another box cannot be used. However, the same passcode can be used for more than one memory box.
- A passcode can be omitted.
- [\*] and [#] cannot be used in a sub-address.
- Do not forget the Print PIN. In the event that you forget the Print PIN or need to verify the Print PIN, contact your SHARP dealer or nearest SHARP Service Department.

# Fax Data Receive/Forward

This section explains settings for reception and forwarding.

## Fax Settings

The following items appear when the "Fax Settings" are configured.

Item	Description
Receive Setting	Set the fax reception method. <ul style="list-style-type: none"> <li>• Auto Reception: When a call comes in, the machine rings and then automatically begins fax reception.</li> <li>• Manual Reception: This can be used when an existing extension phone is connected to the machine. Fax reception is begun by manual operation after answering on the extension phone.</li> </ul>
Multiple Set Print	Specify whether or not two or more copies of received faxes will be printed. The number of copies is set in " <a href="#">Fax Output Settings</a> ", (page 7-113).
Staple	Specify whether or not stapling is performed. (Only when a finisher is installed.)
Forward Received Data	When the machine cannot print because it is out of paper or out of toner, received faxes can be forwarded to another previously stored fax machine.



- If some pages of a fax that is being forwarded were successfully printed, only those pages that were not printed will be forwarded.
- A forwarded fax becomes a fax transmission job. If transmission does not take place because the transmission was canceled or an error occurred, the fax will be held in memory until it can be printed.
- All faxes received are forwarded. Note, however, that faxes received to an F-code confidential memory box cannot be forwarded.
- To store a forwarding fax number, see "[Set the Telephone Number for Data Forwarding](#)" (page 7-112) in the system settings (administrator).
- Forwarding is not possible if no faxes were received or a forwarding fax number is not programmed.
- If "[Hold Setting for Received Data Print](#)" (page 7-79) is enabled, you will be prompted to enter a password. Enter the correct password with the numeric keys.

# System Settings for Fax (Administrator) List

When the system settings for fax are accessed with administrator rights, the following items appear. For information on the general settings, see "[System Settings for Fax \(General\) List](#)" (page 7-101).



- For the procedure for using the system settings (administrator), see "[Accessing the System Settings \(Administrator\)](#)" (page 7-32).
- Depending on the machine specifications and peripheral devices installed, it may not be possible to use some settings.

## Image Send Settings

Item	Factory default setting	Page
■ <a href="#">Image Send Settings</a>		7-109
● <a href="#">Fax Settings</a>		7-109
▶ <a href="#">Fax Default Settings</a>		7-109
◆ <a href="#">Dial Mode Setting</a>	Tone	7-109
◆ <a href="#">Auto Wake Up Print</a>	Enabled	7-109
◆ <a href="#">Pause Time Setting</a>	2 sec.	7-109
◆ <a href="#">Fax Dest. Confirmation Mode</a>	Disabled	7-109
◆ <a href="#">Speaker Settings</a>		7-109
• Speaker	Volume: 5	
• Ringer Volume	Volume: 5	
• Line Monitor	Volume: 5	
• Fax Receive Complete Signal	Volume: 5; Tone Pattern: 3 Transmission Complete Sound Time Setting: 3 sec.	
• Fax Send Complete Signal	Volume: 5; Tone Pattern: 3 Transmission Complete Sound Time Setting: 3 sec.	
• Fax Communication Error Signal	Volume: 5; Tone Pattern: 3 Transmission Complete Sound Time Setting: 0.3 sec. each	
◆ <a href="#">Remote Reception Number Setting</a>	5	7-109
◆ <a href="#">Original Print on Transaction Report</a>	Print Out Error Report Only	7-110

Item	Factory default setting	Page
◆ Transaction Report Print Select Setting		7-110
• Single Sending	Print Out Error Report Only	
• Broadcasting	Print Out All Report	
• Receiving	No Printed Report	
• Confidential Reception	Print Out Notice Page	
◆ Activity Report Print Select Setting		7-110
• Auto Print at Memory Full	Disabled	
• Print Daily at Designated Time	Disabled	
◆ ECM	Enabled	7-110
◆ Distinctive Ring Detection	Off	7-110
▶ Fax Send Settings		7-111
◆ Rotation Sending Setting	All Enabled	7-111
◆ Quick On Line Sending	Enabled	7-111
◆ Printing Page Number at Receiver	Enabled	7-111
◆ Date/Own Number Print Position Setting	Outside the Original Image	7-111
◆ Recall in Case of Line Busy	Recall, Number of Times: 2, Interval: 3 min.	7-111
◆ Recall in Case of Communication Error	Recall, Number of Times: 1, Interval: 3 min.	7-111
▶ Fax Receive Settings		7-112
◆ Number of Calls in Auto Reception	2	7-112
◆ Duplex Reception Setting	Disabled	7-112
◆ Auto Receive Reduce Setting	Enabled	7-112
◆ Print Style Setting	Auto Size Select	7-112
◆ Set the Telephone Number for Data Forwarding	–	7-112
◆ Receiving Date & Time Print	Disabled	7-113
◆ Fax Output Settings	Number of Prints: 1	7-113
▶ Allow/Reject Number Setting	All disabled	7-113
▶ Fax Polling Security	Enabled	7-113



---



---

# Image Send Settings

Settings related to the image send function (scan, Internet fax, etc.) can be configured. Touch the [Image Send Settings] key to configure the settings.

## Fax Settings

### Fax Default Settings

The fax settings can be enabled or disabled to suit the needs of your workplace.

---

### Dial Mode Setting

Select the appropriate setting for your telephone line type.

#### Dial Mode Setting

Select the line type from the list.

#### Auto Select

Select this after the line has been connected to have the machine automatically detect whether your line is a pulse dial line or a tone dial line.

---

### Auto Wake Up Print

When the [POWER] key (⏻) is "off" (but the main power switch is "on") and a fax is received, this function automatically activates the machine and prints the fax. When this function is disabled, received faxes are not printed until the [POWER] key (⏻) is switched "on".

---

### Pause Time Setting

Use this to change the length of pauses inserted in fax numbers.

If a hyphen "-" is entered when dialing or storing a fax number, a pause of 2 seconds is inserted.

The pause can be changed to any number of seconds from 1 to 15.

---

### Fax Dest. Confirmation Mode

This setting specifies whether or not a destination verification message is displayed when sending a fax in order to prevent accidental transmission to the wrong destination.

---

### Speaker Settings

Use these settings to set the sound heard from the speaker for the Speaker, Ringer Volume, Line Monitor, Fax Receive Complete Signal, Fax Send Complete Signal, and Fax Communication Error Signal. For the Fax Receive Complete Signal, the Fax Send Complete Signal, and the Fax Communication Error Signal, the Tone Pattern and Transmission Complete Sound Time Setting can be selected in addition to the volume.

#### Check on Setup Sounds

Use this to check the selected tone pattern and volume.

---

### Remote Reception Number Setting

Fax reception can be activated from an extension phone connected to the machine by entering a 1-digit number and pressing the (\*) key twice on the phone's keypad. This number is called the remote reception number, and you can set it to any number from "0" to "9".

## Original Print on Transaction Report

When a transaction report is printed for a memory transmission, this is used to print part of the first page of the transmitted original on the transaction report. Select one of the settings below.

- Print Out All Report
- Print Out Error Report Only
- No Printed Report

This setting will not be effective if "[Transaction Report Print Select Setting](#)" below is set to "No Printed Report".

## Transaction Report Print Select Setting

This is used to select whether or not a transaction report will be printed, and if printed, the condition for being printed. Select a setting for each of the following operations:

### Single Sending

- Print Out All Report
- Print Out Error Report Only
- No Printed Report

### Broadcasting

- Print Out All Report
- Print Out Error Report Only
- No Printed Report

### Receiving

- Print Out All Report
- Print Out Error Report Only
- No Printed Report

### Confidential Reception

- Print Out Notice Page
- No Printed Report

When a transaction report is printed, you can have part of the first page of the transmitted original printed on the transaction report. For more information, see "[Original Print on Transaction Report](#)".



When transaction report printing is set for "Receiving", a report will not be printed for a reception from a number specified as a reject number in "[Allow/Reject Number Setting](#)" (page 7-113).

## Activity Report Print Select Setting

This is used to have the Image Sending Activity Report that is stored in the machine's memory printed at regular intervals.

The Image Sending Activity Report can be set to automatically print each time the number of transactions reaches 201, and it can also be set to automatically print at a specified time (once a day only). (The settings can be simultaneously enabled.)



- If you only select the "Print Daily at Designated Time" setting  and the number of recorded transactions exceeds 201 before the specified time, each new transaction will delete the oldest transaction (the oldest transaction will not be printed).
- The Image Sending Activity Report can also be printed manually. See "[List Print \(Administrator\)](#)" (page 7-91).

## ECM

Line conditions can sometimes distort a transmitted fax image. When ECM (Error Correction Mode) is turned on, pages that are distorted are automatically re-transmitted.



If the other machine supports Super G3, ECM will function regardless of this setting.

## Distinctive Ring Detection

If multiple telephone numbers have been assigned to your telephone line, the number called can be identified by its ringing pattern. By using one number for voice calls and another number for faxes, you can tell which type of call you are receiving by the ringing pattern. You can set your machine to automatically receive faxes when your fax number is called by setting the pattern that corresponds to your fax number. Six selections are available.

## Fax Send Settings

Settings for fax transmission can be configured.

### Rotation Sending Setting

When transmitting an image that is one of the following sizes, this function rotates the image counterclockwise 90 degrees. (The setting can be configured separately for each size.)

5-1/2" x 8-1/2", B5, A5

### Quick On Line Sending

When this setting is enabled, the machine starts transmitting a fax as soon as the first page is scanned. Transmission takes place at the same time as the remaining pages are being scanned.

If you disable this setting, transmission will not begin until all pages have been scanned. Note that this setting does not apply to manual transmission.

### Printing Page Number at Receiver

This setting is used to add the page number to the top of each fax page printed by the receiving machine.

### Date/Own Number Print Position Setting

This setting determines the position of the date and sender information printed at the top of faxes by the receiving machine. To have the information printed outside the transmitted document image, touch the [Outside the Original Image] key. To have the information printed inside the document image, touch [Inside the Original Image] key. For more information on the print position, see "[ADDING YOUR SENDER INFORMATION TO FAXES \(Own number sending\)](#)" (page 4-91) in "4. FACSIMILE".

### Recall in Case of Line Busy

This program is used to set the number of recall attempts and the interval between recall attempts when a transmission is not successful due to the line being busy or other reason.

#### Number of Times to Recall When Line is Busy

This setting specifies whether or not recalling is performed when the line is busy. When recalling is performed, you can set the number of recall attempts. Any number from 1 to 14 can be selected.

#### Interval to Wait Between Recall Attempts (min.) When Line is Busy

The interval between recall attempts can be set. Any number of minutes from 1 to 15 can be selected.



Even when this setting is enabled, note that your machine will not re-attempt a call when manual transmission or direct transmission is used.

### Recall in Case of Communication Error

This determines how many times your machine will automatically re-attempt the call if a fax transmission fails due to a communication error.

#### Number of Times to Recall in Case of Error

Specify how many times the machine will re-attempt the call when a communication error occurs.

#### Interval to Wait Between Recall Attempts (min.) in Case of Error

The interval between recall attempts can be set. Any number of minutes from 1 to 15 can be selected.



Even when this setting is enabled, note that your machine will not re-attempt a call when manual transmission or direct transmission is used.

## Fax Receive Settings

Settings for fax reception can be configured.

### Number of Calls in Auto Reception

This setting is used to select the number of rings on which the machine automatically receives a call and begins fax reception in auto reception mode. Any number from 0 to 15 can be selected.



If you select "0" for the number of rings, the machine will immediately answer and begin fax reception without ringing in auto reception mode.

### Duplex Reception Setting

This is used to have received faxes printed on both sides of the paper.

When this setting is enabled and a fax consisting of 2 or more pages is received (the pages must be the same size), the pages are printed on both sides of the paper.

### Auto Receive Reduce Setting

When a fax is received that includes the sender's name and number, the received image is slightly larger than the standard size. This setting is used to automatically reduce the image to fit the standard size.



- If Auto Receive Reduce is disabled, the edges of the image outside the standard size will be cut off. However, the image will be clearer because it will be printed at the same size as the original.
- Standard sizes are sizes such as 8-1/2" x 11" and 8-1/2" x 5-1/2" (A4 and B5).

## Print Style Setting

This setting determines the paper selection condition when printing received faxes. Select one of the three conditions below.

### Print Actual Size Cut off Enabled

Each received image is printed at full size. If necessary, the image is divided onto multiple sheets of paper.

### Auto Size Select

Each received image is printed at full size when possible. When not possible, the image is automatically reduced before printing.

## Set the Telephone Number for Data Forwarding

When a problem prevents the machine from printing a received fax, the received fax can be forwarded to another fax machine. This setting is used to program the fax number of the destination fax machine. Only one forwarding fax number can be programmed (maximum of 64 digits).

To insert a pause between digits of the number, touch the [-] key.

If you wish to specify an F-code confidential memory box in the destination machine, touch the [/] key after entering the fax number and enter the F-code (sub-address and passcode).

## Receiving Date & Time Print

Enable this setting to have the date and time of reception printed.

Select [Inside the Received Image] or [Outside the Received Image] for the position where the date and time is printed.

When [Inside the Received Image] is selected, the date and time of reception is printed on the received image.

When [Outside the Received Image] is selected, the received image is reduced and the date and time of reception is printed in the blank area that results.



[Outside the Received Image] cannot be selected for the reception date and time print setting when "Auto Receive Reduce Setting" (page 7-112) is not enabled.

## Fax Output Settings

These settings are used to select the number of copies for received faxes.

### Number of Prints

Set the number of copies of received faxes that are printed to any number from 1 to 99.



This setting can only be used when the [Multiple Set Print] checkbox is selected  in "Fax Settings" (page 7-106).

## Allow/Reject Number Setting

Use this setting to specify whether reception from a stored number is to be allowed or rejected.

Item	Description
Reject Reception	Reject reception from the stored number.
Allow Reception	Allow reception from the stored number.
All Invalid	Even if numbers have been stored, disregard the numbers and allow reception from all numbers.
Add New	Store a new number for which allow or reject will be specified (maximum of 50 numbers). Enter the number (maximum of 20 digits) and touch the [Store] key.
Registration Number List	A list of the stored numbers can be displayed. A number can be selected in this screen to delete it from the list.



When no numbers have been stored for allow/reject specification, no keys other than [Add New] can be selected.

## Fax Polling Security

The following settings are for regular polling memory using the Public Box.

### Set Fax Polling Security

When the memory polling function is used, this setting determines whether any machine will be allowed to poll your machine, or only machines that have been stored in your machine.

### Add New

When the Polling Security Setting is enabled, use this setting to store (or delete) the fax numbers of the machines that are allowed to poll your machine. The stored fax numbers are called passcode numbers. Up to 10 passcode numbers can be stored (maximum of 20 digits each).

### Passcode Number Key List

This shows a list of the stored passcode numbers. A number can be selected to delete it.



Note that these settings do not apply to F-code polling memory.

# APPENDIX

## System Settings Menu

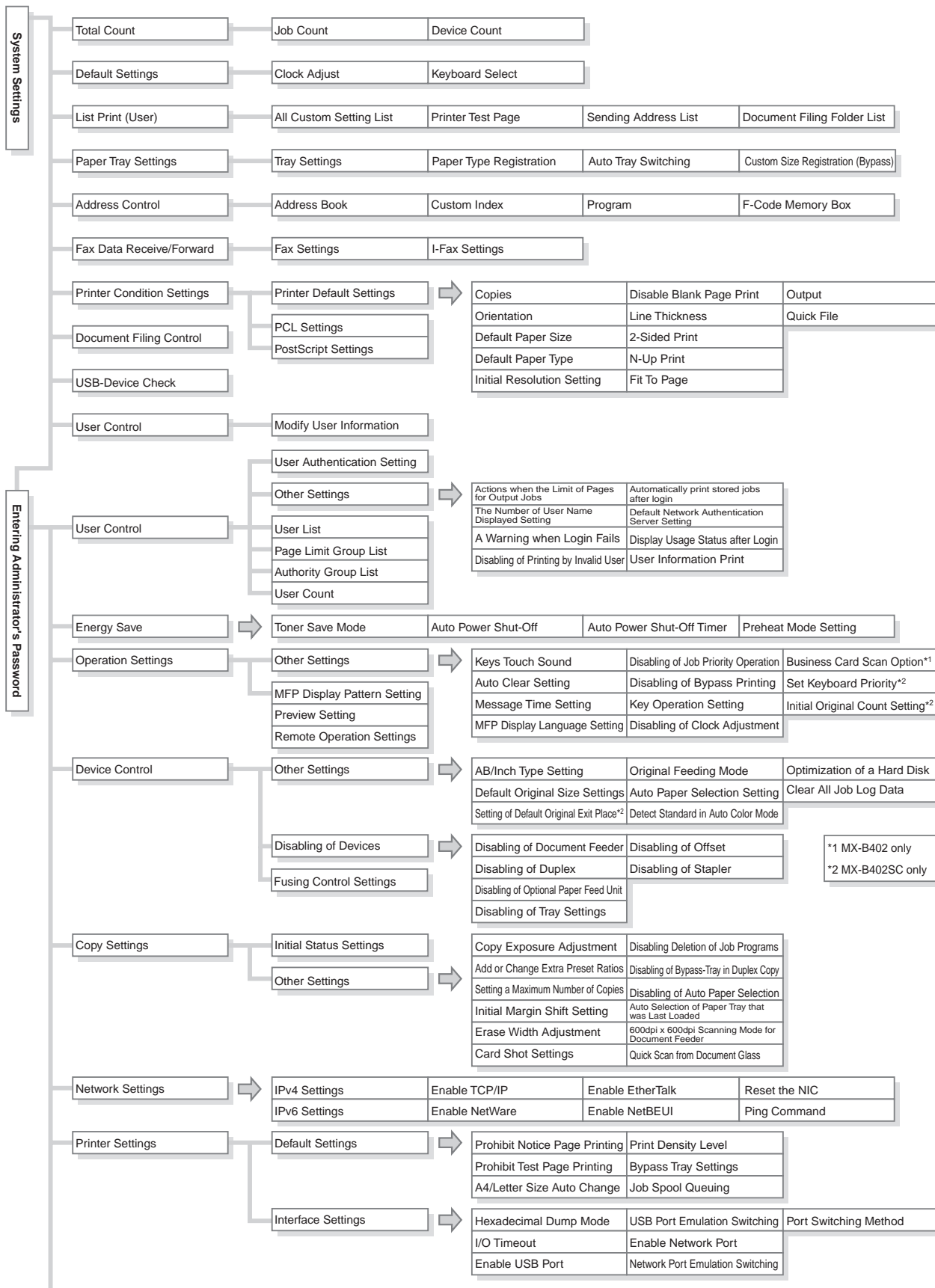

Image Send Settings	Operation Settings	Other Settings	Default Display Settings	Scan Complete Sound Setting	Erase Width Adjustment
			Address Book Default Selection	The Number of File Name/Subject/Body Keys Displayed Setting	
			Initial Resolution Setting	The Number of Direct Address Keys Displayed Setting	
			Default Exposure Settings	Disable Switching of Display Order	
			Must Input Next Address Key at Broadcast Setting	Hold Setting for Received Data Print	
		Settings to Disable Registration	Disable Registering Destination from Operation Panel	Disable Registration of Program	Disable Destination Registration Using Global Address Search
			Disable Registering Destination on Web Page	Disable Registration of Memory Box	Disable Registration Using Network Scanner Tool
		Settings to Disable Transmission	Disable [Resend] on Image Send Mode	Disable Direct Entry	Disable PC-Fax Transmission
		Own Name and Destination Set	Disable Selection from Address Book	Disable PC-I-Fax Transmission	
Scan Settings	Other Settings	Default Sender Set	Compression Mode at Broadcasting	Bcc Setting	
	Default Address Setting	Default Color Mode Settings	Maximum Size of E-mail Attachments (E-mail)	Disable Scan Function	
		Initial File Format Setting	Maximum Size of Data Attachments (FTP/Desktop/Network Folder)	Pre-Setting Mail Signature	
I-Fax Settings	I-Fax Default Settings	Auto Wake Up Print	Original Print on Transaction Report	Body Text Print Select Setting	
		Compression Setting	Transaction Report Print Select Setting	Pre-Setting Mail Signature	
		Speaker Volume Setting	Activity Report Print Select Setting		
	I-Fax Send Settings	I-Fax Reception Report On/Off Setting	Maximum Size of E-mail Attachments	Recall in Case of Line Busy	
		I-Fax Reception Report Request Timeout Setting	Rotation Sending Setting	Recall in Case of Communication Error	
		Number of Resend Times at Reception Error	Printing Page Number at Receiver		
	I-Fax Receive Settings	Auto Receive Reduce Setting	Receiving Date & Time Print		
	Allow/Reject Mail or Domain Name Setting	Duplex Reception Setting	POP3 Communication Timeout Setting		
		Set Address for Data Forwarding	Reception Check Interval Setting		
Fax Settings	Fax Default Settings	Dial Mode Setting	Remote Reception Number Setting	Distinctive Ring Detection	
		Auto Wake Up Print	Original Print on Transaction Report		
		Pause Time Setting	Transaction Report Print Select Setting		
		Fax Dest. Confirmation Mode	Activity Report Print Select Setting		
		Speaker Settings	ECM		
	Fax Send Settings	Rotation Sending Setting	Date/Own Number Print Position Setting		
		Quick On Line Sending	Recall in Case of Line Busy		
		Printing Page Number at Receiver	Recall in Case of Communication Error		
	Fax Receive Settings	Number of Calls in Auto Reception	Print Style Setting	Fax Output Settings	
	Allow/Reject Number Setting	Duplex Reception Setting	Set the Telephone Number for Data Forwarding		
	Fax Polling Security	Auto Receive Reduce Setting	Receiving Date & Time Print		
Document Filing Settings	Other Settings	Default Mode Settings	Default Exposure Settings	Erase Width Adjustment	
	Document Output Options	Sort Method Setting	Initial Resolution Settings	Card Shot Settings	
	Automatic Deletion of File Settings	Administrator Authority Setting	Scan Complete Sound Setting		
		Delete All Quick Files	Disable Stamp for Reprinting		
		Default Color Mode Settings	Batch Print Settings		
List Print (Administrator)	Administrator Settings List	Image Sending Activity Report	Data Receive/Forward List	Web Settings List	Metadata Set List
Security Settings	SSL Settings	IPsec Settings	IEEE802.1X Setting		
Enable/Disable Settings					
Change Administrator Password					
Product Key					
Data Backup	Storage Backup	Device Cloning			
Storing/Calling of System Settings	Restore Factory Defaults	Store Current Configuration	Restore Configuration		
Sharp OSA Settings	External Account Setting	USB Driver Settings	Job Priority Preference		



# CHAPTER 8

# TROUBLESHOOTING

This chapter provides solutions to possible problems in a question and answer format. Locate the question that relates to your problem and use the answer to help correct the situation. If you are unable to solve a problem using this manual, please contact your dealer or nearest SHARP Service Department.

## System settings

System settings are indicated in the "Solutions" column as shown below. In some cases a problem may be solved by enabling the indicated system setting.

Example:

→ System Settings (Administrator) > "Copy Function Settings" > "Other Settings" > "Rotation Copy Setting" >   
This is an abbreviated description of the procedure for selecting the setting. ">" indicates the setting sequence and  indicates the state of the setting after it has been enabled. Use these descriptions as a quick manual to help you configure the settings.

## TROUBLESHOOTING PROBLEMS

### FREQUENTLY ASKED QUESTIONS

- MAKING A COPY OF A NON-STANDARD SIZE ORIGINAL ..... 8-4
- I CAN'T PRINT FROM A COMPUTER... ..... 8-5
- PRINTING ON ENVELOPES ..... 8-7
- CHANGING THE PAPER SIZE USED FOR A PRINT JOB ..... 8-8
- ADJUSTING THE VOLUME OF THE RINGER ..... 8-9
- THE MACHINE STARTS PRINTING WHEN I TRY TO FORWARD DATA..... 8-9
- CHECKING THE MACHINE'S COMMUNICATION RECORD ..... 8-9

### REMOVING MISFEEDS

- REMOVING MISFEEDS. .... 8-10
- HOW TO REMOVE MISFEEDS. .... 8-11

### REMOVING STAPLE JAMS

- FINISHER. .... 8-15

### INSTALLING THE SOFTWARE

- WHEN INSTALLATION WAS NOT SUCCESSFUL ..... 8-17
- THE PRINTER DRIVER CANNOT BE INSTALLED (Windows 2000/XP/Server 2003) ..... 8-19

## COPYING

- PROBLEMS RELATED TO COPYING OPERATION ..... 8-20
- PROBLEMS RELATED TO COPY RESULTS..... 8-21

## PRINTING

- PROBLEMS RELATED TO PRINTING OPERATION ..... 8-22
- PROBLEMS RELATED TO PRINT RESULTS..... 8-25

## FACSIMILE

- PROBLEMS RELATED TO TRANSMISSION ..... 8-28
- PROBLEMS RELATED TO RECEPTION .... 8-30
- PROBLEMS RELATED TO TELEPHONE .... 8-31
- PROBLEMS RELATED TO AUDIBLE SIGNALS ..... 8-31
- PROBLEMS RELATED TO ONE-TOUCH INDIVIDUAL KEYS / GROUP KEYS ..... 8-32





**SCANNING / INTERNET FAX**

- PROBLEMS RELATED TO SCANNING / INTERNET FAX OPERATION . . . . . 8-33
- PROBLEMS RELATED TO SCAN RESULTS . . . . . 8-36
- PROBLEMS RELATED TO ONE-TOUCH INDIVIDUAL KEYS / GROUP KEYS . . . . . 8-38

**DOCUMENT FILING**

- PROBLEMS RELATED TO FILING . . . . . 8-39
- PROBLEMS RELATED TO FILE MANAGEMENT . . . . . 8-40

**GENERAL PROBLEMS**

- PROBLEMS RELATED TO MACHINE OPERATION . . . . . 8-43
- PROBLEMS RELATED TO PAPER FEEDING AND OUTPUT . . . . . 8-45
- PROBLEMS RELATED TO QUALITY / PRINT RESULTS . . . . . 8-46
- PROBLEMS RELATED TO PERIPHERAL DEVICES . . . . . 8-48
- OTHER PROBLEMS . . . . . 8-50

# TROUBLESHOOTING PROBLEMS

The chart below shows the procedure to follow in the event a problem occurs. Use it as a troubleshooting guide.



## Check this chapter first

You may find a solution to your problem here.



## Ask the administrator for help

Inform the machine's administrator of the nature of the problem and ask for help.



## Refer to other instruction manuals

You can sometimes find the solution to your problem in other chapters in this manual or in the other instruction manuals included with the machine.

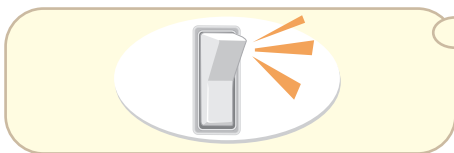

## Turn the power off and then on again

Turning the power off and on may solve the problem in some cases, so try doing so before attributing the problem to a malfunction.

Press the [POWER] key (⏻) to turn off the power and switch the main power switch to the "off" position. Wait at least 10 seconds and then switch the main power switch and the [POWER] key (⏻) back on in that order.

- When turning off the power, always wait for 20 seconds between turning off the [POWER] switch (⏻) and switching off the main power switch.
- Before turning off the main power switch, check that the print mode DATA indicator and the image send mode LINE and DATA indicators on the operation panel are not lit up or flashing.



## Contact your dealer or nearest Sharp Service Department.

If, having tried the above steps, your problem remains unsolved, contact the dealer from whom you purchased the machine or your nearest Sharp Service Department.

# FREQUENTLY ASKED QUESTIONS

## MAKING A COPY OF A NON-STANDARD SIZE ORIGINAL

The procedure for making a copy of a payment slip or other non-standard size original is explained below.

The "Centering" special mode of copy mode can be selected to position the copied image in the center of the paper.

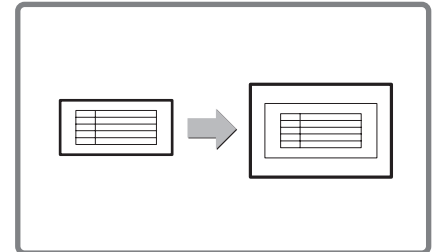

### - 1 Place the originals. \_\_\_\_\_

If the dimensions of the document are less than the following dimensions, place the original on the document glass.

When using the MX-B402:

X dimension (width): 3-1/2" (89 mm)

Y dimension (height): 4" (100 mm)

When using the MX-B402SC:

X dimension (width): 3-1/4" (85 mm)

Y dimension (height): 2" (51 mm)

When using the automatic document feeder, use "Slow Scan Mode" for a thin original.

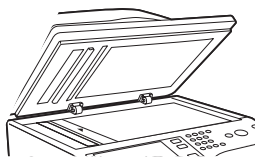

### - 2 Enter the original size. \_\_\_\_\_

From the base screen of copy mode, touch [Original] then [Size Input].

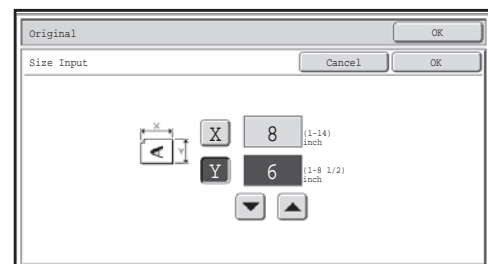

### 3 Place paper in the bypass tray.

The bypass tray is used here to copy onto paper that is not loaded in any of the paper trays of the machine.

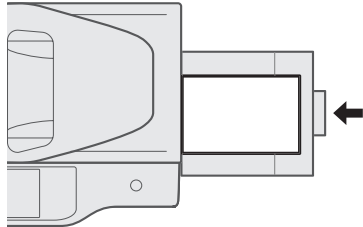

Type : Recycled  
Size : 8-1/2" x 11"

### 4 Select the bypass tray.

From the base screen of copy mode, touch [Paper Select] and then "Bypass tray paper type".

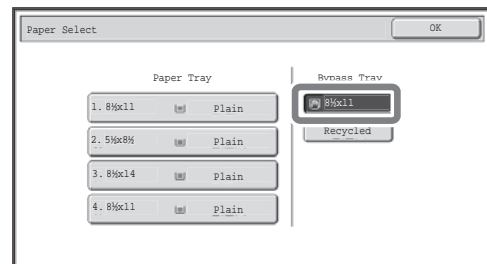
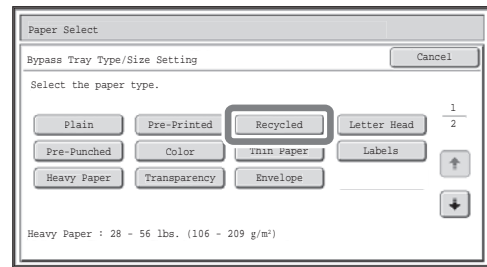

## I CAN'T PRINT FROM A COMPUTER...

First check that the printer driver for the machine is selected when printing.  
Also check that the printer driver port is set correctly.

### Checking the printer name

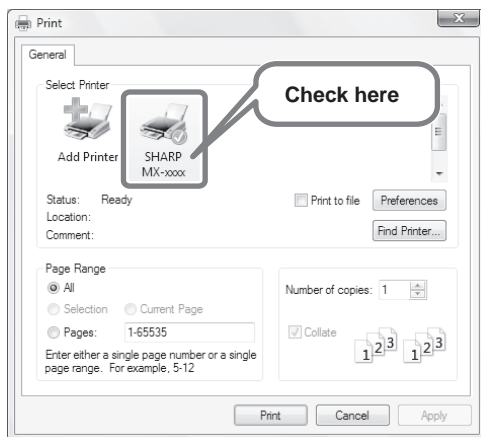

Check that the machine is selected in the Print dialog box, and select the machine if it is not.

If your machine is not listed, the printer driver is not installed. Install the printer driver and try again.

## Checking port settings in the printer driver

Display the printer driver's Properties dialog box and click the [Port] tab.

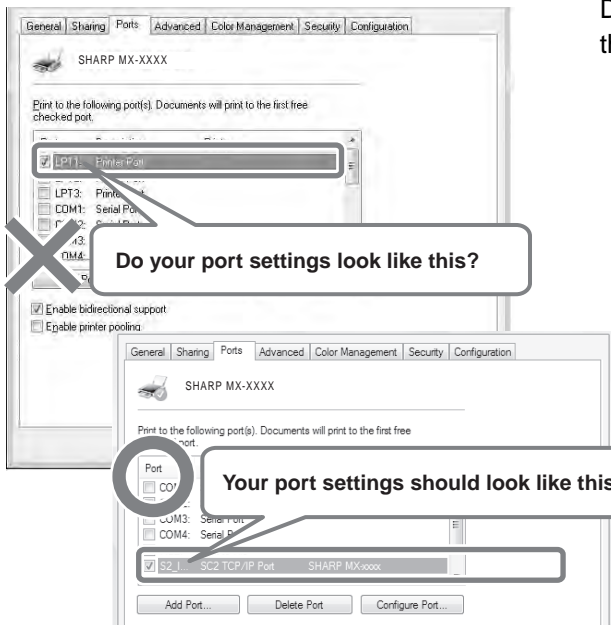

# PRINTING ON ENVELOPES

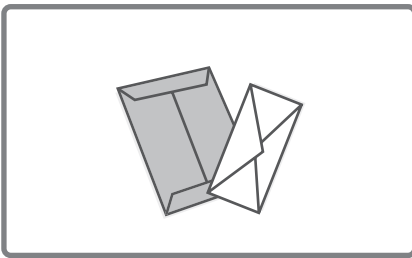

The procedure for printing on an envelope is explained below. Only the name and address side of an envelope can be printed on. It is recommended that you do a test print to check the print result before using an envelope.

## 1 Place paper in the bypass tray.

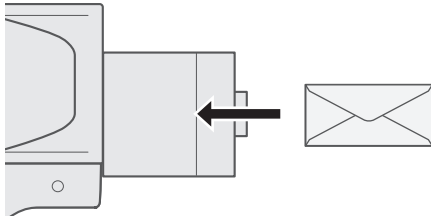

Print on the name and address side

## 2 Tray Settings.

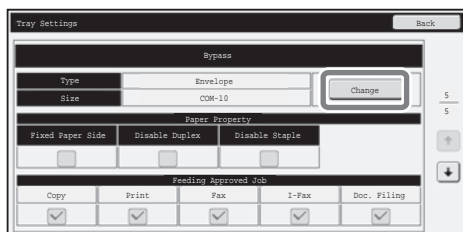

Type : Envelope  
Size : Select the envelope size

## 3 Select settings in the printer driver.

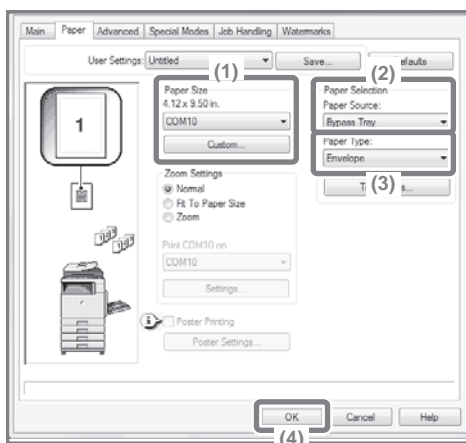

(1) Select the size of the envelope in "Paper Size".

(2) Select "Bypass Tray" from "Paper Source" in "Paper Selection".

(3) Select [Envelope] in "Paper Type".

If needed, select the "Rotate 180 degrees" checkbox () in "Image Orientation" on the [Main] tab.

(4) Click the [OK] button.

# CHANGING THE PAPER SIZE USED FOR A PRINT JOB

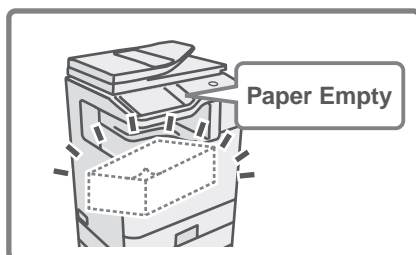

When the size of paper specified for a print job is not loaded in any of the machine's paper trays, follow the steps below to change the paper size.

## 1 Check details on the job.

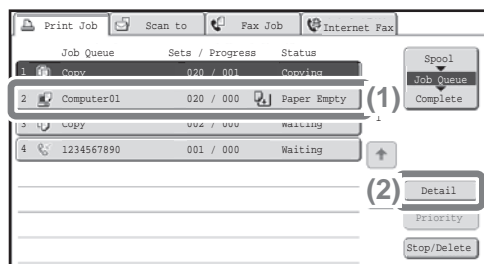

Press the [JOB STATUS] key on the operation panel to display the job status screen.

(1) Select the job whose status is [Paper Empty].

(2) Touch the [Detail] key.

To delete the job, you can press the [Stop/Delete] key.

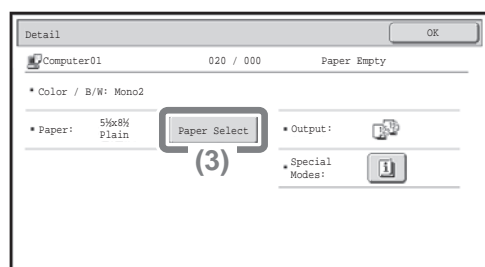

(3) Check the paper size specified for the job in the detail screen, and touch the [Paper Select] key.

## 2 Change the paper size used for the job.

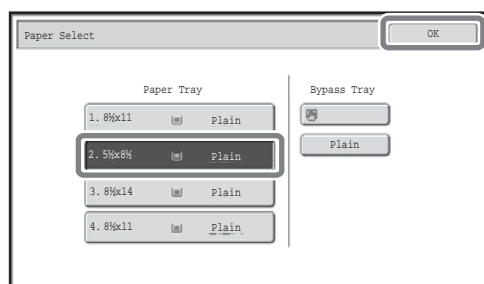

Select the paper size on which you wish to print the job from the set paper sizes.

To avoid cutting off part of the image, select a paper size that is larger than the paper size specified for the job.

## ADJUSTING THE VOLUME OF THE RINGER

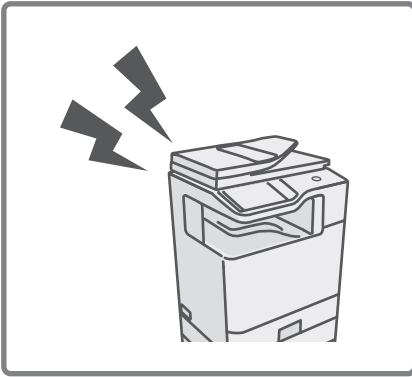

If the ringing sound made when the machine receives a fax is too loud or too soft, follow the steps below to adjust the volume.

The fax ringer volume is adjusted in the system settings (administrator).

Press the [SYSTEM SETTINGS] key on the operation panel, touch [Image Send Settings] - [Fax Settings] - [Fax Default Settings] - [Speaker Settings] - [Ringer Volume] in that order, and then select the desired volume.

## THE MACHINE STARTS PRINTING WHEN I TRY TO FORWARD DATA...

Before forwarding received fax data to a shared folder, check that destination computer is turned on.

If the computer is not turned on, the machine prints the received fax data. If data is being forwarded to several computers, received data is printed if even one of the computers is turned off.

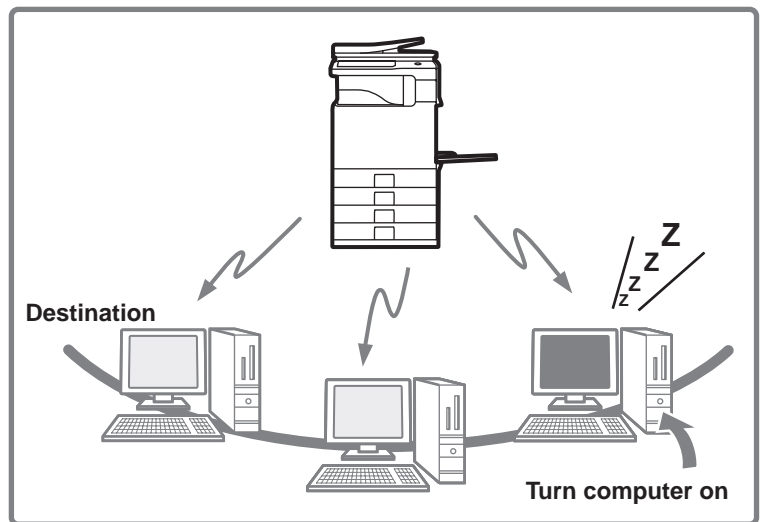

## CHECKING THE MACHINE'S COMMUNICATION RECORD

To check the machine's record of communication using the image send function, follow the steps below to print the image sending activity report.

The image sending activity report is printed from the system settings (administrator).

Press the [SYSTEM SETTINGS] key on the operation panel, and then touch [List Print (Administrator)] - [Image Sending Activity Report] to print the report.

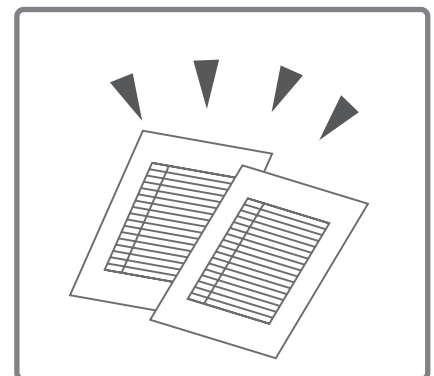



# REMOVING MISFEEDS

This section explains what to do when a paper misfeed occurs in the machine.



## Caution

**The fusing unit is hot. Take care not to burn yourself when removing a misfeed.**



- When removing misfed paper, do not touch or damage the transfer belt.
- Carefully pull the paper out without tearing it.
- A misfeed may have occurred inside the machine. Check carefully and remove the misfeed.
- If the paper tears, be sure to remove all pieces from the machine.

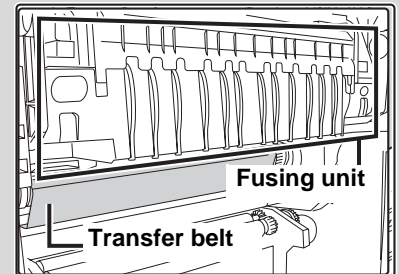

## REMOVING MISFEEDS

When a paper misfeed occurs, the message "A misfeed has occurred." will appear in the touch panel and printing and scanning will stop. In this event, touch the [Information] key in the touch panel. When the key is touched, instructions for removing the misfeed will appear. Follow the instructions. When the misfeed is cleared, the message will automatically clear.

The approximate locations of possible misfeeds are indicated by blinking ▼ marks as shown below.

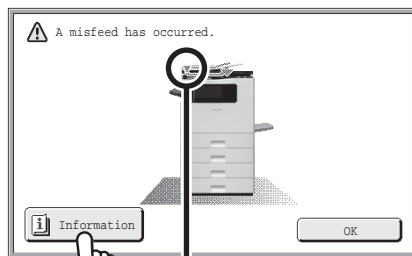

Misfeed location

**When using the MX-B402**

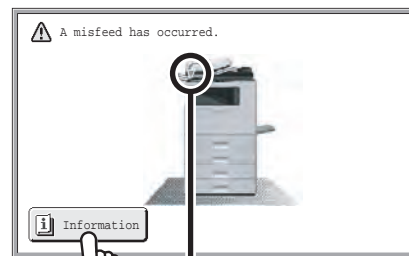

Misfeed location

**When using the MX-B402SC**



- While the message appears, printing and scanning cannot be resumed.
- If the message does not clear even after the misfeed has been removed, the causes below are possible. Check once again.
  - The misfeed was not correctly removed.
  - A torn piece of paper remains in the machine.
  - A cover or unit that was opened or moved to remove the misfeed was not returned to its original position.

# HOW TO REMOVE MISFEEDS

If you require more information when reading the instructions in the touch panel, see the paper misfeed illustrations below. Refer to the illustration below and then go to the appropriate illustration (1 to 10) for your situation.

☞ (1): page 8-11, (2)-(8): page 8-12, (9)-(10): page 8-14



When removing a misfeed or closing a cover, tray, or the finisher, take care that your fingers do not become pinched.

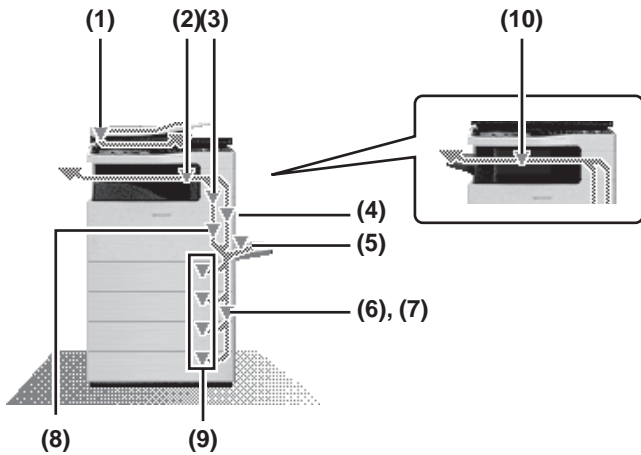

When using the MX-B402

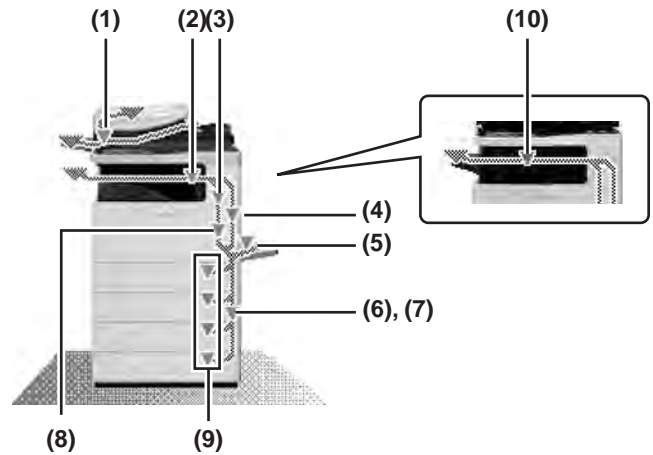

When using the MX-B402SC

## (1) Original misfeed

### When using the MX-B402

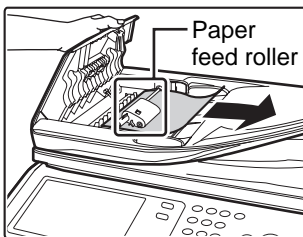

Open the document feeder cover and remove the paper feed roller.

If it is difficult to remove misfed paper, remove the paper feed roller. To remove the paper feed roller, see "[Removing the paper feed roller](#)".

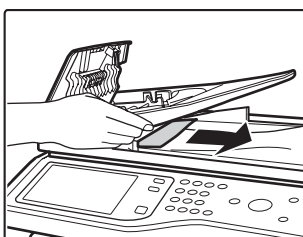

Pull out the document feeder tray and remove the misfed paper.

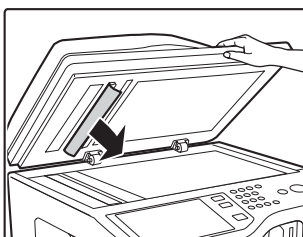

Open the automatic document feeder and remove the original.



After removing the misfeed, open and close the automatic document feeder (or the document feeding area cover or document feeder tray) to clear the misfeed display from the touch panel.

## Removing the paper feed roller

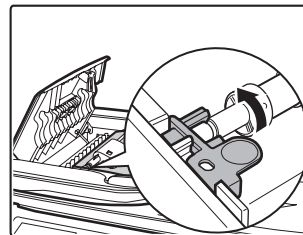

Lift up the knob that holds the roller shaft.

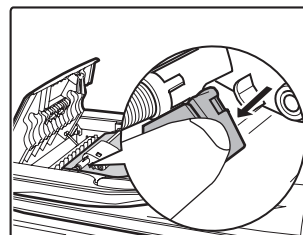

Pull down the release lever.

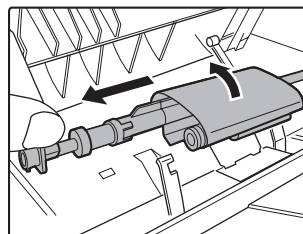

Remove the shaft rotating the roller cover upward and remove the shaft.



- If the roller cover is not pointing straight up when the shaft is removed, a failure may occur.
- Carefully pull the misfed paper out without tearing it.

**(1) Original misfeed**

When using the MX-B402SC

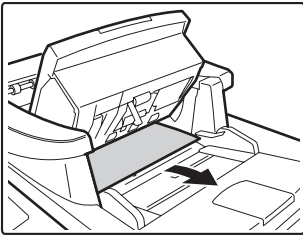

Open the document tray and remove misfeed originals.

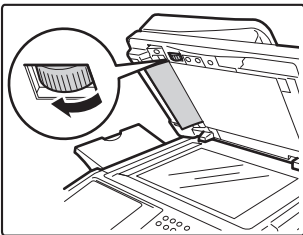

Open the automatic document feeder and remove misfeed originals while rotating the transfer roller in the direction of the arrow.

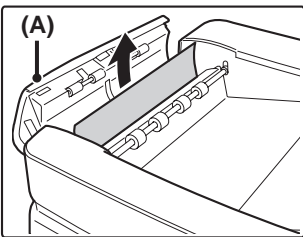

Open A section's cover and remove misfeed originals.

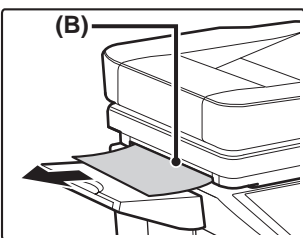

Remove misfeed originals in B section.

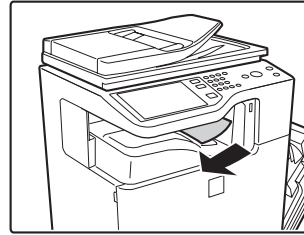
**(2) Paper misfeed in the output area**

Remove the misfed paper.

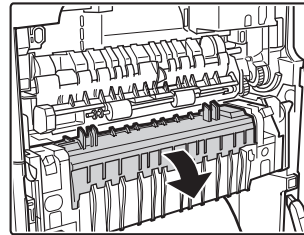
**(3) Paper misfeed in the fusing unit**

If a paper misfeed has occurred inside the fusing unit, press down on the green part, open the fusing unit, and remove the paper.

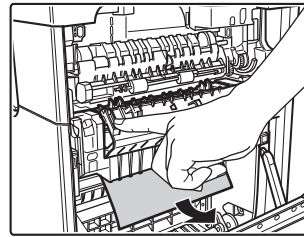
**⚠ Caution**

- The fusing unit area is hot. Take care not to burn yourself. (Do not touch any metal parts.)
- When the fusing unit is tilted down toward you, projections come out in the middle. Do not touch the projections. These can be a cause of human injury or machine failure.



Unfused toner may remain on the paper that is removed. Take care that it does not soil your hands or clothing.

**(4) Paper misfeed in the transport area**

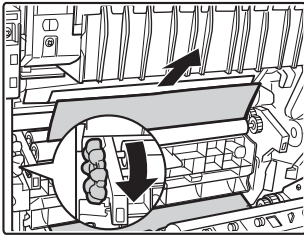

When the rotate knob is turned in the direction of the arrow, paper comes out for above.

**(8) Paper misfeed in tray 2 to tray 4 (side)**

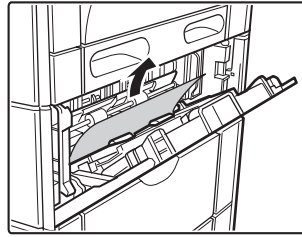

The misfeed may have occurred inside the machine. Check carefully and remove it.

**(5) Paper misfeed in the reversing unit**

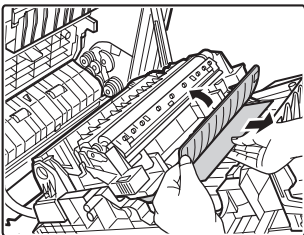

Open the right side cover, open the paper conveyor cover, and remove the paper.

**(9) Paper misfeed in tray 1 to tray 4 (in the tray)**

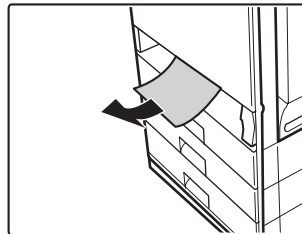

When a paper gets twisted to the roller, remove the tray and remove the misfeed paper.

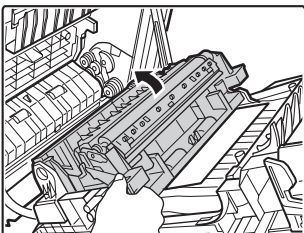

If the misfeed is not in the above location, grasp the handle on the secondary transfer roller unit, slowly open the unit, and remove the paper.

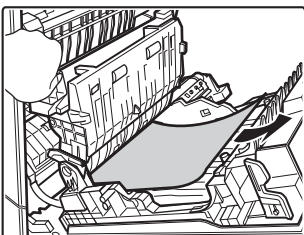

When pulling out a tray, be sure to open the right cover and check for a paper misfeed. If a tray is pulled out when there is a misfeed, the paper will tear and a torn piece may remain in the machine, making it more difficult to remove the misfed paper. To open the right cover and check for a misfeed, follow the procedure in [\(7\) Paper misfeed in tray 1 \(side\)](#) or [\(8\) Paper misfeed in tray 2 to tray 4 \(side\)](#).



When opening the paper reversing section, open slowly and gently. Jerking the section open may cause the secondary transfer roller unit to detach, resulting in failure.

**(6) Paper misfeed in the bypass tray**

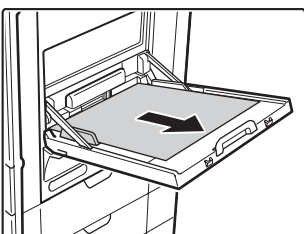

Remove the misfed paper.

**(7) Paper misfeed in tray 1 (side)**

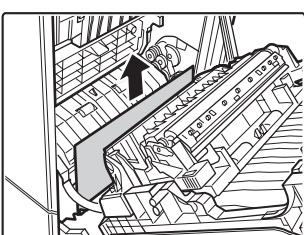

Open the right side cover and remove the misfed paper.

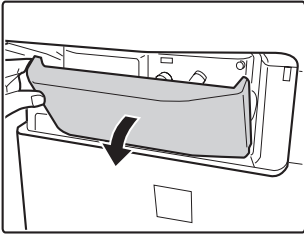
**(10) Paper misfeed in the finisher**

Open the front cover.

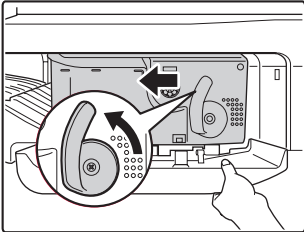

While pressing the lever over to the left, slide the finisher to the left until it stops.

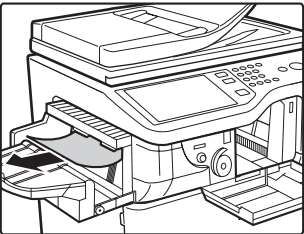

Remove the misfed paper.

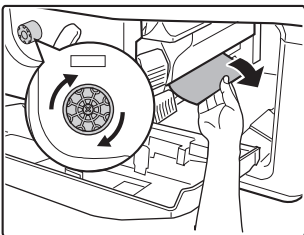

Turn roller rotating knob in the direction of the arrow to remove the misfed paper.

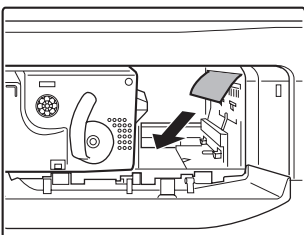

Make sure that there is no misfed paper in the machine.

# REMOVING STAPLE JAMS

Follow the steps below to remove a staple jam.

## FINISHER



### Caution

Take care that a bent staple does not hurt you.

1

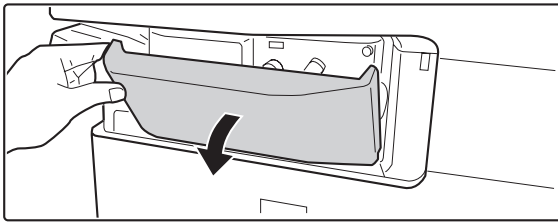

Open the cover.

2

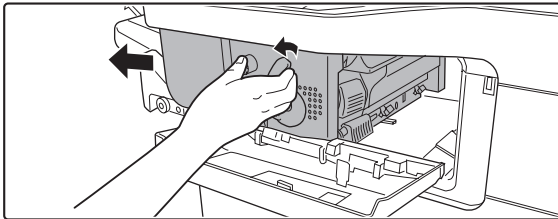

While pressing the lever over to the left, slide the finisher to the left until it stops.

Gently slide the finisher until it stops.

3

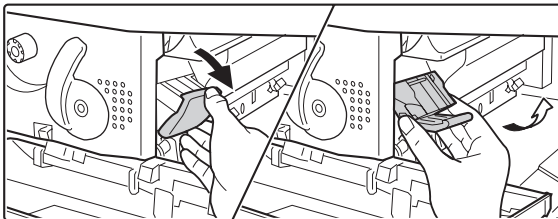

Lower the staple case release lever and remove the staple case.

Pull the staple case out to the right.

4

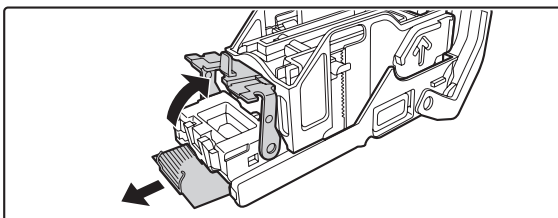

Raise the lever at the front end of the staple case and remove the jammed staple.

Remove the leading staple if it is bent. If bent staples remain, a staple jam will occur again.

5

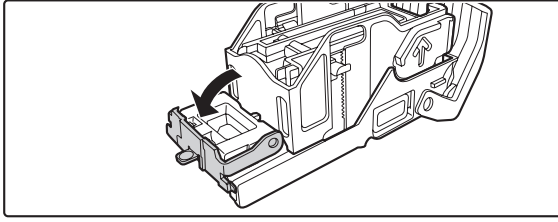

**Lower the lever at the front end of the staple case.**

6

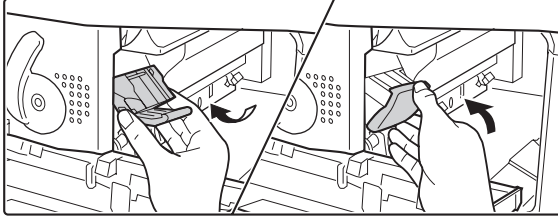

**Replace the staple case.**

Push the staple case in until it clicks into place.

7

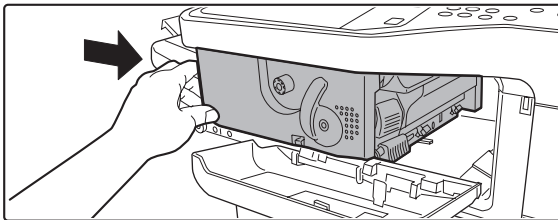

**Slide the finisher back to the right.**

Gently slide the finisher back to the right until it locks into its original position.

8

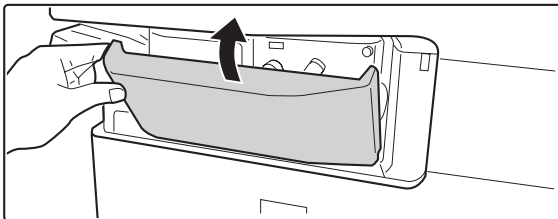

**Close the cover.**



# INSTALLING THE SOFTWARE

## WHEN INSTALLATION WAS NOT SUCCESSFUL

- The software cannot be installed.....8-17
- The machine is not detected (when connected to a network). . . . .8-17
- The plug and play screen does not appear (USB connection in Windows).....8-18
- The printer driver is not installed correctly by plug and play (USB connection in Windows). . . . .8-19

## THE PRINTER DRIVER CANNOT BE INSTALLED (Windows 2000/XP/Server 2003)

## WHEN INSTALLATION WAS NOT SUCCESSFUL

Problem	Point to check	Solution
<b>The software cannot be installed.</b>	Is there sufficient free space on your hard drive?	<b>Check remaining drive space.</b> Delete any unneeded files and applications to increase free space on your hard drive.
	Are you using an operating system that is not supported?	<b>Make sure that the software can run on your operating system.</b> For detailed information on installation requirements for each software program in Windows, click the [Display Readme] button in the installer. In a Macintosh environment, this can be checked in "ReadMe First" in the [US-English] folder ([English] folder in areas other than the U.S.) in the [Readme] folder of the "Software CD-ROM".
<b>The machine is not detected (when connected to a network).</b>	Is the IP address of the machine configured?	<b>Check IP address settings.</b> If the IP address of the machine is not configured, the machine will not be detected. Make sure that the IP address is configured correctly in "Network Settings" in the machine's system settings (administrator). → System Settings (Administrator) > "Network Settings"
	Is your computer connected to the same network as the machine?	<b>Check network connection status.</b> Windows: If the machine and your computer are not connected to the same local area network, the machine will not be detected. If the two are connected to different sub-networks, click the [Specify condition] button and enter the machine's name (host name) or IP address to search for the machine. Macintosh: If multiple AppleTalk zones exist, select the zone to which the machine is connected from the menu.

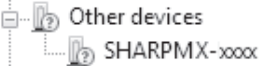

Problem	Point to check	Solution
<b>The machine is not detected (when connected to a network).</b>	Is the machine power on?	<b>Switch on the main power switch and the [POWER] key (⏻) in that order.</b> (In Windows, search again after powering on the machine.) If the machine is powered off, it will not be detected.
	Is your computer connected correctly to the machine?	<b>Make sure that the cable is connected securely to the LAN connectors on your computer and the machine.</b> Check the connections at the hub as well.
<b>The plug and play screen does not appear (USB connection in Windows).</b>	Is the machine power on?	<b>When a USB cable is connected, make sure the power of the machine is "ON" and then connect a USB cable to the machine.</b> When the machine is not powered on, switch on the main power switch and the [POWER] key (⏻) in that order.
	Can your computer use a USB connection?	<b>Check your computer whether or not a USB interface can be used on the Device Manager in your computer.</b> (For information on "Device Manager", see Help in Windows.) If USB can be used, your controller chipset type and root hub will appear in "Universal Serial Bus controllers" in "Device Manager". (The items that appear will vary depending on your computer.)  If these two items appear, USB should be useable. If a yellow exclamation point appears next to "Universal Serial Bus controllers" or the two items do not appear, refer to your computer manual or check with the manufacturer of your computer to enable USB and then reinstall the printer driver.

Problem	Point to check	Solution
<p>The printer driver is not installed correctly by plug and play (USB connection in Windows).</p>	<p>Did you connect the machine to your computer before installing the printer driver?</p>	<p><b>Check the details below and reinstall the printer driver correctly.</b></p> <p>If the machine was connected to your computer with a USB cable when the printer driver was installed, check if information on the unsuccessful installation remains in "Device Manager". (For information on "Device Manager", see Help in Windows.)</p> <p>If the model name of the machine appears in "Other devices" in "Device Manager", delete it, restart your computer, and install the printer driver again.</p> 

## THE PRINTER DRIVER CANNOT BE INSTALLED (Windows 2000/XP/Server 2003)

If the printer driver cannot be installed on Windows 2000/XP/Server 2003, follow the steps below to check your computer settings.

1

### Click the [start] button and then click [Control Panel].

In Windows 2000, click the [Start] button, point to [Settings], and click [Control Panel].

2

### Click [Performance and Maintenance] and then [System].

In Windows 2000, double-click the [System] icon.

3

### Click the [Hardware] tab and then the [Driver Signing] button.

4



### Check the settings in "What action do you want Windows to take?" ("File signature verification" in Windows 2000).

If [Block] is selected, the printer driver cannot be installed. Select [Warn] and install the printer driver again.

# COPYING

## PROBLEMS RELATED TO COPYING OPERATION

- Copying does not take place. . . . .8-20
- Two-sided copying does not take place. . . . .8-21
- The paper size of a tray cannot be set. . . . .8-21

## PROBLEMS RELATED TO COPY RESULTS

- The image is too light or too dark. . . . .8-21
- Part of the image is cut off. . . . .8-21
- Copies come out blank. . . . .8-21

- If you cannot find the item that you are looking for in the above table of contents, see "GENERAL PROBLEMS" (page 8-42).
- If you are unable to solve a problem using the solutions in this manual, switch off the [POWER] key (⏻) and the main power switch. Wait at least 10 seconds, and then switch on the main power switch and the [POWER] key (⏻) in that order.

### Caution:

When the LINE indicator is lit or the DATA indicator is lit or blinking, do not switch off the main power switch or unplug the power plug. This may damage the hard drive or cause the data being stored or received to be lost.

## PROBLEMS RELATED TO COPYING OPERATION

Problem	Point to check	Solution
Copying does not take place.	Have functions been disabled by the administrator?	<b>Check with your administrator.</b> Some functions may have been disabled in the system settings (administrator). When user authentication is enabled, the functions that you can use may be restricted in your user settings.

Problem	Point to check	Solution
<b>Two-sided copying does not take place.</b>	Does the paper type setting of the selected tray specify a type of paper that cannot be used for two-sided copying?	<b>Check "Tray Settings" in the system settings.</b> If the [Disable Duplex] checkbox is selected <input checked="" type="checkbox"/> , two-sided copying using that tray will not be possible. Change the paper type setting to a type that can be used for two-sided printing. → System Settings > "Paper Tray Settings" > "Tray Settings" > "Change"
	Are you using a special size or type of paper?	<b>For the paper types and sizes that can be used for two-sided copying, see "SPECIFICATIONS" in the Start Guide.</b>
	Are you copying using settings that do not allow two-sided copying?	Two-sided copying can generally be combined with other special modes, however, some combinations are not possible. If a prohibited combination is selected, a message will appear in the touch panel.
	Have functions been disabled by the administrator?	<b>Check with your administrator.</b> Some functions may have been disabled in the system settings (administrator). Check with your administrator. When user authentication is enabled, the functions that you can use may be restricted in your user settings.
<b>The paper size of a tray cannot be set.</b>	Have functions been disabled by the administrator?	<b>Check with your administrator.</b> Some functions may have been disabled in the system settings (administrator). Check with your administrator.

## PROBLEMS RELATED TO COPY RESULTS

Problem	Point to check	Solution
<b>The image is too light or too dark.</b>	Is the image too light or too dark?	<b>Select an appropriate exposure mode for the original being copied and adjust the exposure level manually.</b>
	If you selected an original type instead of "Auto" for the copy exposure setting, is the selected original type appropriate for your original?	Select the original type that matches your original. If the wrong type is selected, suitable image adjustment will not be possible.
<b>Part of the image is cut off.</b>	Has an appropriate ratio been selected for the original size and paper size?	<b>Select an appropriate ratio setting.</b>
	Are you using an AB size original?	<b>When copying an AB size original, specify the original size manually.</b>
	Has the correct original size been set?	Touch the [Original] key and select the correct size.
<b>Copies come out blank.</b>	Is the original placed face up or face down correctly?	<b>When using the document glass, the original must be placed face down. When using the automatic document feeder, the original must be placed face up.</b>

# PRINTING

## PROBLEMS RELATED TO PRINTING OPERATION

- Printing does not take place. . . . . 8-22
- Two-sided printing does not take place. . . . . 8-24
- Direct printing of a file in a shared folder on a computer is not possible. . . . . 8-24
- A tray, finisher, or other peripheral device installed on the machine cannot be used. . . . . 8-24

## PROBLEMS RELATED TO PRINT RESULTS

- The image is grainy. . . . . 8-25
- The image is too light or too dark. . . . . 8-25
- Text and lines are faint and difficult to see. . . . . 8-25
- Part of the image is cut off. . . . . 8-25
- The image is upside down. . . . . 8-26
- Many nonsense characters are printed. . . . . 8-26

- If you cannot find the item that you are looking for in the above table of contents, see "GENERAL PROBLEMS" (page 8-42).
- If you are unable to solve a problem using the solutions in this manual, switch off the [POWER] key (⏻) and the main power switch. Wait at least 10 seconds, and then switch on the main power switch and the [POWER] key (⏻) in that order.

### Caution:

**When the LINE indicator is lit or the DATA indicator is lit or blinking, do not switch off the main power switch or unplug the power plug. This may damage the hard drive or cause the data being stored or received to be lost.**

## PROBLEMS RELATED TO PRINTING OPERATION

Problem	Point to check	Solution
Printing does not take place.	Is your computer connected correctly to the machine?	<p><b>Make sure that the cable is connected securely to the LAN connector or the USB connector on your computer and the machine.</b></p> <p>If you are on a network, check the connections at the hub as well.</p> <p>☞ 1. BEFORE USING THE MACHINE "SIDE AND BACK" (page 1-7)</p>
	Is the machine connected to the same network (LAN, etc.) as your computer?	<p><b>The machine must be connected to the same network as your computer.</b></p> <p>If you do not know which network the machine is connected to, ask the network administrator.</p>

Problem	Point to check	Solution
<b>Printing does not take place.</b>	Is the IP address selected correctly? (Windows)	<p><b>Check the IP address setting.</b></p> <p>If the machine does not have a permanent IP address (the machine receives an IP address from a DHCP server), printing will not be possible if the IP address changes. Print the "All Custom Setting List" in the system settings and check the IP address of the machine. If the IP address has changed, change the port setting in the printer driver.</p> <p>→ System Settings &gt; "List Print (User)" &gt; "All Custom Setting List"</p> <p>📖 Start Guide</p> <p>If the IP address changes frequently, it is recommended that a permanent IP address be assigned to the machine.</p> <p>→ System Settings (Administrator) &gt; "Network Settings"</p>
	Are you using a printer port created using Standard TCP/IP Port? (Windows 2000/XP/Server 2003/Vista/Server 2008/7)	<p><b>Check the settings of your computer.</b></p> <p>When a port created with Standard TCP/IP Port in Windows is used and the [SNMP Status Enabled] checkbox is <input checked="" type="checkbox"/>, it may not be possible to print correctly. Change the [SNMP Status Enabled] checkbox to <input type="checkbox"/>.</p> <p>📖 1. BEFORE USING THE MACHINE "Software Setup Guide"</p>
	Is "Connect via" set to [Ethernet] for AppleTalk? (Mac OS 9.0-9.2.2)	<p><b>Open [AppleTalk] from the [Control Panels] and make sure that [Ethernet] is selected in the "Connect via" menu.</b> Printing is not possible if [Ethernet] is not selected.</p>
	Is your computer in an unstable state?	<p><b>Restart your computer.</b></p> <p>Printing is sometimes not possible when running multiple applications at once, or there is insufficient memory or hard drive space.</p>
	Is the machine specified correctly in the software application that you are using for printing?	<p>Make sure that the printer driver of the machine is selected in the Print window of the application. If the printer driver does not appear in the list of available printer drivers, it may not be installed correctly. Remove the printer driver and then install it once again.</p> <p>📖 1. BEFORE USING THE MACHINE "Software Setup Guide"</p>
	Are the network connection devices operating normally?	<p><b>Make sure that the routers and other network connection devices are operating correctly.</b> If a device is not powered on or is in an error state, see the manual of the device to correct the problem.</p>

Problem	Point to check	Solution
Printing does not take place.	Is the I/O timeout setting too short?	<b>Check with your administrator.</b> If the I/O timeout setting is too short, errors may occur while writing to the printer. Ask the administrator of the machine to configure an appropriate time in "I/O Timeout". → System Settings (Administrator) > "Printer Settings" > "Interface Settings" > "I/O Timeout"
	Was a Notice Page printed?	<b>Check the printed Notice Page.</b> A Notice Page will be printed to indicate the cause of the problem if a print job cannot be performed as specified and the cause is not shown in the display. Read the printed page and take appropriate action. For example, a notice page will be printed in the following situations. <ul style="list-style-type: none"> <li>• The print job is too large to fit in memory.</li> <li>• A function that has been prohibited by the administrator is specified.</li> </ul> By factory default, Notice Pages are not printed.
	Have functions been disabled by the administrator?	<b>Check with your administrator.</b> When user authentication is enabled, the functions that you can use may be restricted in your user settings.
Two-sided printing does not take place.	Does the paper type setting of the selected tray specify a type of paper that cannot be used for two-sided printing?	<b>Check "Tray Settings" in the system settings.</b> If the [Disable Duplex] checkbox is selected <input checked="" type="checkbox"/> , two-sided printing using that tray will not be possible. Change the paper type setting to a type that can be used for two-sided printing. → System Settings > "Paper Tray Settings" > "Tray Settings" > "Change"
	Are you using a special size or type of paper?	For the paper types and sizes that can be used for two-sided printing, see "SPECIFICATIONS" in the Start Guide.
	Have functions been disabled by the administrator?	<b>Check with your administrator.</b> Some functions may have been disabled in the system settings (administrator). When user authentication is enabled, the functions that you can use may be restricted in your user settings.
Direct printing of a file in a shared folder on a computer is not possible.	Is "IPsec Settings" enabled on the machine?	<b>Check with your administrator.</b> When "IPsec Settings" is enabled in the system settings (administrator), direct printing of a file in a shared folder may not be possible in some computer environments. → System Settings (Administrator) > "Security Settings" > "IPsec Settings"
A tray, finisher, or other peripheral device installed on the machine cannot be used.	Have the peripheral devices that are installed on the machine been configured in the printer driver?	Open the printer properties and click the [Auto Configuration] button on the [Configuration] tab. (Windows) If auto configuration cannot be executed, see the 1. BEFORE USING THE MACHINE "Software Setup Guide".

# PROBLEMS RELATED TO PRINT RESULTS

Problem	Point to check	Solution
<b>The image is grainy.</b>	Are the printer driver settings appropriate for the print job?	<p><b>Check the settings of the printer driver.</b> When selecting print settings, you can set the print mode to [Normal], [High Quality], or [Fine]. When you need a very clear image, select [Fine]. (The print mode cannot be used when using the PCL5e printer driver.)</p> <p>Windows: The resolution setting is selected in the [Advanced] tab of the printer driver properties window.</p> <p>Macintosh: This is done in the [Advanced] menu of the [Printer Features] menu of the print screen.</p>
<b>The image is too light or too dark.</b>	Does the image (particularly a photo) need correction? (Windows)	<p><b>Check the settings of the printer driver.</b> Brightness and contrast can be corrected by performing [Image Adjustment] on the [Advanced] tab of the printer driver. These settings can be used for simple corrections when you do not have image editing software installed on your computer.</p>
<b>Text and lines are faint and difficult to see.</b>	Was color data printed? (Windows)	<p><b>Check the settings of the printer driver.</b> When color text and lines are printed, they may become faint and difficult to see. To have color text or lines (areas) that are faint converted to black, select [Text To Black] or [Vector To Black] on the [Advanced] tab of the printer driver. (Raster data such as bitmap images cannot be adjusted.)</p>
<b>Part of the image is cut off.</b>	Does the paper size specified by the job match the size of paper loaded in the tray?	<p><b>Make sure that the paper size setting matches the size of paper loaded in the tray.</b> The paper size setting is selected as follows:</p> <p>Windows: On the [Paper] tab of the printer driver. If [Fit to Paper Size] is selected, check the loaded paper and the paper size setting.</p> <p>Macintosh: In the [Page Setup] menu.</p>
	Is the print orientation setting (portrait or landscape) correct?	<p><b>Set the print orientation to match the image.</b> The print orientation is selected as follows:</p> <p>Windows: On the [Main] tab of the printer driver. Macintosh: In the [Page Setup] menu.</p>
	Are the margins set correctly in the layout settings of the application?	<p><b>Select an appropriate paper size and margins in the layout settings of the application.</b> If the edge of the image extends outside the printable area of the machine, the edge will be cut off.</p>



Problem	Point to check	Solution
<p><b>The image is upside down.</b></p>	<p>Are you using a type of paper (punch paper, etc.) that can only be loaded in a fixed orientation?</p>	<p><b>Rotate the image 180 degrees before printing.</b>            When the image size and paper size are the same but the orientations are different, the orientation of the image is automatically rotated to match the paper. However, when the paper can only be loaded in a fixed orientation, this may result in the image being printed upside down. The 180 degree rotation setting is selected as follows:            Windows:              On the [Main] tab of the printer driver.            Macintosh:              On the [Page Setup] menu. (Landscape orientation only.)              (In Mac OS 9.0 to 9.2.2, in the [PostScript Options] menu of the [Page Setup] menu.)</p>
	<p>Is the correct binding position selected for two-sided printing?</p>	<p><b>Be sure to set the appropriate binding position.</b>            When two-sided printing is performed, every other page is printed upside down when tablet binding is selected for the binding position. The binding position is selected as follows:            Windows:              On the [Main] tab of the printer driver.            Macintosh:              In the [Layout] menu of the print window. (In Mac OS 9.0 to 9.2.2, in [Output/Document Style].)</p>
<p><b>Many nonsense characters are printed.</b></p>	<p>Is your computer or the machine in an unstable state?</p>	<p><b>Cancel printing, restart your computer and the machine, and try printing again.</b>            If little free space remains in the memory or hard drive of your computer, or many jobs have been spooled on the machine and it has little free memory remaining, printed text may turn into nonsense characters.            To cancel printing            Windows:              Double-click the printer icon that appears at the lower right of the task bar and click "Cancel All Documents" (or "Purge Print Documents") in the [Printer] menu.            Macintosh:              Double-click the name of the machine in the printer list, select the job that you wish to delete, and delete it. (In Mac OS 9.0 to 9.2.2, double-click the printer icon on the desktop, select the print job that you wish to delete, and delete it.)            At the machine:              Press the [JOB STATUS] key on the operation panel, touch the [Print Job] tab to change the screen, touch the key of the print job that you wish to delete, and touch the [Stop/Delete] key. A message appears to confirm the cancelation. Touch the [Yes] key.            If nonsense characters are still printed after restarting, ask your administrator to lengthen the timeout setting of "I/O Timeout" in the system settings (administrator).              → System Settings (Administrator) &gt; "Printer Settings" &gt; "Interface Settings" &gt; "I/O Timeout"             If nonsense characters are still printed after taking the above measures, remove and then reinstall the printer driver.</p>

# FACSIMILE

## PROBLEMS RELATED TO TRANSMISSION

- Transmission does not take place. . . . .8-28
- The transmitted fax prints out blank at the receiving side. . . . .8-29
- The transmitted fax is reduced by the receiving fax machine. . . . .8-29
- Transmission does not begin at the specified time. . . . .8-29

## PROBLEMS RELATED TO RECEPTION

- Printing does not take place after reception. . . . .8-30
- The received image is faint. . . . .8-30
- Manual reception / polling reception are not possible. . . . .8-30
- The machine does not begin fax reception. . . . .8-30

## PROBLEMS RELATED TO TELEPHONE

- Dialing is not possible. . . . .8-31
- You cannot talk to the other party. . . . .8-31

## PROBLEMS RELATED TO AUDIBLE SIGNALS

- The volume is too low. . . . .8-31
- No sound is heard. . . . .8-31

## PROBLEMS RELATED TO ONE-TOUCH INDIVIDUAL KEYS / GROUP KEYS

- A one-touch individual key or group key cannot be stored. . . . .8-32
- A one-touch individual key or group key cannot be edited or deleted. . . . .8-32

- If you cannot find the item that you are looking for in the above table of contents, see "GENERAL PROBLEMS" (page 8-42).
- If you are unable to solve a problem using the solutions in this manual, switch off the [POWER] key (⏻) and the main power switch. Wait at least 10 seconds, and then switch on the main power switch and the [POWER] key (⏻) in that order.

### Caution:

**When the LINE indicator is lit or the DATA indicator is lit or blinking, do not switch off the main power switch or unplug the power plug. This may damage the hard drive or cause the data being stored or received to be lost.**

# PROBLEMS RELATED TO TRANSMISSION

Problem	Point to check	Solution
Transmission does not take place.	Is the telephone line connected securely?	Check the telephone line jack, the wall jack, and any extension adapters to make sure that all connections are secure.  <a href="#">CONNECTION TO THE TELEPHONE LINE</a> (page 4-4)
	Is the correct dial mode set for your line?	Ask your administrator to verify that "Dial Mode Setting" is set correctly for the line you are using. → System Settings (Administrator) > "Image Send Settings" > "Fax Settings" > "Fax Default Settings" > "Dial Mode Setting"
	Is a busy signal received?	If a busy signal is received, the transmission is temporarily canceled and then automatically re-attempted after a brief interval. (Factory default setting: 2 attempts, 3 min. intervals) → System Settings (Administrator) > "Image Send Settings" > "Fax Settings" > "Fax Send Settings" > "Recall in Case of Line Busy" To cancel the transmission, press the [JOB STATUS] key, touch the key of the job that you wish to cancel, and then touch the [Stop/Delete] key.
	Did a communication error occur?	If an error occurs that prevents transmission, the transmission is temporarily canceled and then automatically re-attempted after a brief interval. (Factory default setting: 3 min. intervals) → System Settings (Administrator) > "Image Send Settings" > "Fax Settings" > "Fax Send Settings" > "Recall in Case of Communication Error" To cancel the transmission, press the [JOB STATUS] key, touch the key of the job that you wish to cancel, and then touch the [Stop/Delete] key. The machine supports error correction mode (ECM) and is configured to automatically resend any part of a fax that is distorted due to noise on the line. → System Settings (Administrator) > "Image Send Settings" > "Fax Settings" > "Fax Default Settings" > "ECM"
	Does a message appear indicating that the memory is full?	If the memory becomes full, the transmission canceled. Divide the originals into sets and separately, or use direct transmission.
	Has the correct original size been set?	When an original is placed, the detected original size is displayed. If the original size displayed in this key is different from the size of the original you placed, be sure to touch this key and specify the correct size.

Problem	Point to check	Solution
<b>Transmission does not take place.</b>	Does the job status screen (completed jobs) or a transaction report indicate that the transmission was not successful?	<p><b>Perform the transmission again.</b></p> <p>If the transmission is still not successful after recalling is performed as set in "Recall in Case of Line Busy" or "Recall in Case of Communication Error", the transmission failure will be indicated in the job status screen and the transaction report.</p> <p>→ System Settings (Administrator) &gt; "Image Send Settings" &gt; "Fax Settings" &gt; "Fax Send Settings" &gt; "Recall in Case of Line Busy"</p> <p>→ System Settings (Administrator) &gt; "Image Send Settings" &gt; "Fax Settings" &gt; "Fax Send Settings" &gt; "Recall in Case of Communication Error"</p>
	Did you place a long size original on the document glass when it is scanned?	<p><b>Place originals in the document feeder tray of the automatic document feeder.</b></p> <p>A long size original cannot be scanned from the document glass.</p>
	Are the sub-address and passcode correct? (When using F-code communication)	<p><b>Check with the operator of the other machine to make sure that the sub-address and passcode are correct.</b></p>
	Have functions been disabled by the administrator?	<p><b>Check with your administrator.</b></p> <p>When user authentication is enabled, the functions that you can use may be restricted in your user settings.</p>
<b>The transmitted fax prints out blank at the receiving side.</b>	Is the original placed face up or face down correctly?	<p><b>Place the original correctly and send the fax again.</b></p> <p>When using the document glass, the original must be placed face down. When using the automatic document feeder, the original must be placed face up. Place the original correctly and send the fax again.</p>
	If the receiving machine is using thermal paper, was the thermal paper loaded with the wrong side out?	<p><b>Check with the operator of the receiving machine.</b></p>
<b>The transmitted fax is reduced by the receiving fax machine.</b>	Has image rotation been enabled?	<p><b>Enable "Rotation Sending Settings" before transmission.</b></p> <p>When "Rotation Sending Setting" is not enabled (the image is not rotated), an original placed in the vertical orientation may be reduced by the receiving machine.</p> <p>→ System Settings (Administrator) &gt; "Image Send Settings" &gt; "Fax Settings" &gt; "Fax Send Settings" &gt; "Rotation Sending Setting" &gt; <input checked="" type="checkbox"/></p> <p>If "Mixed Size Originals" in the special modes is enabled and an original with a different width is sent, rotate transmission will be disabled.</p>
<b>Transmission does not begin at the specified time.</b>	Is the machine's clock set to the correct time?	<p><b>Set the clock to the correct time.</b></p> <p>→ System Settings &gt; "Default Settings" &gt; "Clock" &gt; "Clock Adjust"</p>
	Is a transmission in progress?	<p>If another transmission is in progress when the specified time arrives, the timer operation will begin after that transmission is finished.</p>

## PROBLEMS RELATED TO RECEPTION

Problem	Point to check	Solution
<b>Printing does not take place after reception.</b>	Does a message appear in the display instructing you to add toner or paper? (Printing is not possible when this screen appears.)	<b>Restore printing capability as instructed by the message.</b>
	Does a password entry screen appear?	<b>Enter the correct password with the numeric keys.</b> "Hold Setting for Received Data Print" is enabled. If you do not know the password, check with your administrator.
	Is forwarding (Inbound Routing function) selected in the Web page for a received fax?	<b>If you need to print a received fax, ask your administrator.</b> When the Inbound Routing function is enabled in the Web pages, received faxes are automatically forwarded to a specified address. If "Print at Error" is selected when Inbound Routing is enabled, received faxes will only be printed when an error occurs.
<b>The received image is faint.</b>	Is the original that was faxed also faint?	<b>Ask the other party to send the fax again using a suitable (darker) exposure setting.</b>
<b>Manual reception / polling reception are not possible.</b>	Is little free memory remaining?	Free memory by printing faxes received by confidential reception and other received data that is protected by a password, and by deleting data stored in memory boxes.
<b>The machine does not begin fax reception.</b>	Has the reception mode been set to "Manual Reception" in the system settings?	When the reception mode is set to "Manual Reception", the machine will not receive faxes automatically. To have the machine receive faxes automatically, set the reception mode to "Auto Reception". → System Settings > "Fax Data Receive/Forward" > "Fax Settings" > "Receive Setting"

## PROBLEMS RELATED TO TELEPHONE

Problem	Point to check	Solution
<b>Dialing is not possible.</b>	Is the extension phone connected?	<b>Check connections.</b> Check the telephone line jack, the extension phone jack, the wall jack, and any extension adapters to make sure that all connections are secure.
<b>You cannot talk to the other party.</b>	Did you dial using the speaker?	<b>Use the extension phone.</b> When you dial using the speaker, you will be able to hear the voice of the other party, but he or she will not hear your voice. (When the extension phone is not installed, you cannot talk to the other party.)

## PROBLEMS RELATED TO AUDIBLE SIGNALS

Problem	Point to check	Solution
<b>The volume is too low.</b> <ul style="list-style-type: none"> <li>• Speaker</li> <li>• Ringer Volume</li> <li>• Line Monitor</li> <li>• Fax Receive Complete Signal</li> <li>• Fax Send Complete Signal</li> <li>• Fax Communication Error Signal</li> </ul>	Has the volume been set to a low level in the system settings (administrator)?	<b>Ask your administrator to set the volumes in "Speaker Settings" to a higher level.</b> → System Settings (Administrator) > "Image Send Settings" > "Fax Settings" > "Fax Default Settings" > "Speaker Settings"
<b>No sound is heard.</b> <ul style="list-style-type: none"> <li>• Ringer Volume</li> <li>• Line Monitor</li> <li>• Fax Receive Complete Signal</li> <li>• Fax Send Complete Signal</li> <li>• Fax Communication Error Signal</li> </ul>	Has the ringer volume been turned off in the system settings (administrator)?	<b>Ask your administrator to set the volumes in "Speaker Settings" to other than "No Sound".</b> → System Settings (Administrator) > "Image Send Settings" > "Fax Settings" > "Fax Default Settings" > "Speaker Settings"

# PROBLEMS RELATED TO ONE-TOUCH INDIVIDUAL KEYS / GROUP KEYS

Problem	Point to check	Solution
A one-touch individual key or group key cannot be stored.	Has the maximum number of keys been stored?	<b>Delete one-touch keys and group keys that are not being used.</b>
	Have functions been disabled by the administrator?	<b>Check with your administrator.</b> Some functions may have been disabled in the system settings (administrator).
A one-touch individual key or group key cannot be edited or deleted.	If the key is an individual key, is the key included in a group?	<b>Remove the key from the group and then edit or delete the key.</b> (If the key is included in multiple groups, it must be removed from all groups.) → System Settings > "Address Control" > "Address Book"  If multiple group keys have been stored, print the Group List in "Sending Address List" in the system settings. The list will show where the key is stored. → System Settings > "List Print (User)" > "Sending Address List" > "Group List"
	Is the key being used in a reserved transmission or a transmission in progress?	<b>Wait until the transmission is finished or cancel the transmission and then edit or delete the key.</b>
	Is the key included in a program key?	<b>Remove the key from the program and then edit or delete the key.</b> (If the key is included in program, it must be removed from program.) → System Settings > "Address Control" > "Program"  If multiple program keys have been stored, print the Program List in "Sending Address List" in the system settings. The list will show where individual and group keys are stored. → System Settings > "List Print (User)" > "Sending Address List" > "Program List"
	Is the key that you wish to edit or delete stored as a relay destination of an F-code relay broadcast transmission?	<b>Remove the key from the relay destinations of the F-code relay broadcast transmission and then edit or delete the key.</b> An individual or group one-touch key that is stored as a relay destination cannot be edited or deleted. → System Settings > "Address Control" > "F-Code Memory Box"
	Have functions been disabled by the administrator?	<b>Check with your administrator.</b> Some functions may have been disabled in the system settings (administrator).
	Has your administrator enabled a function that prevents editing/deleting?	<b>Check with your administrator.</b> If your administrator has enabled settings such as "Inbound Routing Settings" (in the Web pages), editing/deleting will not be possible.

# SCANNING / INTERNET FAX

## PROBLEMS RELATED TO SCANNING / INTERNET FAX OPERATION

- Transmission does not take place. . . . . 8-33
- An address cannot be specified. . . . . 8-34
- Mode cannot be selected. . . . . 8-34
- Auto selection of the color mode does not take place correctly. . . . . 8-34
- The received image file cannot be opened. . . . . 8-35
- Transmission takes a long time. . . . . 8-35
- A destination is pre-selected. . . . . 8-35
- Cannot write to USB memory. (When using USB Memory Scan.) . . . . . 8-35

## PROBLEMS RELATED TO SCAN RESULTS

- The scanned image is clipped. . . . . 8-36
- The quality of the scanned image is poor. . . . . 8-36
- The scanned image is blank. . . . . 8-36
- The scanned image is upside down or on its side. . . . . 8-36
- The scanned image is black and white. . . . . 8-37
- JPEG was selected for the file type but the file was created as a TIFF file. . . . . 8-37
- The image is too light or too dark. (When using PC Scan.) . . . . . 8-37

## PROBLEMS RELATED TO ONE-TOUCH INDIVIDUAL KEYS / GROUP KEYS

- A one-touch individual key or group key cannot be stored. . . . . 8-38
- A one-touch individual key or group key cannot be edited or deleted. . . . . 8-38

- If you cannot find the item that you are looking for in the above table of contents, see "GENERAL PROBLEMS" (page 8-42).
- If you are unable to solve a problem using the solutions in this manual, switch off the [POWER] key (⏻) and the main power switch. Wait at least 10 seconds, and then switch on the main power switch and the [POWER] key (⏻) in that order.

### Caution:

**When the LINE indicator is lit or the DATA indicator is lit or blinking, do not switch off the main power switch or unplug the power plug. This may damage the hard drive or cause the data being stored or received to be lost.**

## PROBLEMS RELATED TO SCANNING / INTERNET FAX OPERATION

Problem	Point to check	Solution
Transmission does not take place.	Did you select the correct destination? Is the correct information (e-mail address or FTP server information) stored for that destination?	<b>Make sure that the correct destination information is stored for the destination and that the destination is correctly selected.</b> If delivery by e-mail (Scan to E-mail) is unsuccessful, an error message such as "Undelivered Message" may be sent to the designated administrator's e-mail address. This information may help you determine the cause of the problem.



Problem	Point to check	Solution
<b>Transmission does not take place.</b>	Does the image file exceed the e-mail attachment limit set in the system settings (administrator)?	<b>Check with your administrator.</b> If your administrator has set a limit on the size of transmitted files, a file that exceeds the limit cannot be transmitted.
	Did the image file exceed the file attachment size limit of your mail server? (When Scan to E-mail is used.)	<b>Reduce the size of the file attachment (reduce the number of pages scanned).</b> The size of the file can also be reduced by scanning using a lower resolution setting. Ask your mail server administrator what the file size limit is for one e-mail transmission.
	Has the folder on the destination computer been set as a shared folder so that files can be sent to it? (When using Scan to Network Folder.)	<b>If the destination folder is not configured as a shared folder, select "share" in the folder properties.</b> If the folder was moved or otherwise changed, the "share" setting may have been canceled.
	Is "IPsec Settings" enabled on the machine? (When using Scan to Network Folder.)	When "IPsec Settings" is enabled in the system settings (administrator), direct printing of a file in a shared folder may not be possible in some computer environments. For information about "IPsec settings", consult your administrator. → System Settings (Administrator) > "Security Settings" > "IPsec Settings"
	Did you place a long size original on the document glass when it is scanned?	<b>Place originals in the document feeder tray of the automatic document feeder.</b> A long size original cannot be scanned from the document glass.
<b>An address cannot be specified.</b>	Have functions been disabled by the administrator?	<b>Check with your administrator.</b> Some functions may have been disabled in the system settings (administrator). Check with your administrator. When user authentication is enabled, the functions that you can use may be restricted in your user settings.
<b>Mode cannot be selected.</b>		
<b>Auto selection of the color mode does not take place correctly.</b>	Are you scanning one of the following types of originals? <b>When Black &amp; White is not selected:</b> <ul style="list-style-type: none"> <li>• Are there colors or coloring in the paper?</li> </ul> <b>When Color is not selected:</b> <ul style="list-style-type: none"> <li>• Is the color in the original very light?</li> <li>• Is the color in the original very dark, almost black?</li> <li>• Is only a very small area of the original colored?</li> </ul>	When the color mode is set to "Auto", the machine detects whether the original is black and white or color when the [START] key is pressed; however, in the cases at left, automatic detection may not give the correct result. In this event, specify the color mode manually.

Problem	Point to check	Solution
The received image file cannot be opened.	Does the viewer program used by the recipient support the format of the received image data?	<p><b>Use a software program that is capable of opening the selected file type and compression mode.</b></p> <p>The recipient may be able to open the file if you change the file type and compression mode selected at the time of transmission.</p>
	Does a message appear prompting you to enter your password?	<p><b>Ask the sender for the password, or have the image sent again in a non-encrypted format.</b></p> <p>The received file is an encrypted PDF file.</p>
Transmission takes a long time.	Is the resolution setting appropriate at the time of scanning?	<p><b>Select resolution and data compression settings that are suited to the purpose of transmission.</b></p> <p>To create image data that is balanced in terms of resolution and file size, pay attention to the following points:</p> <p>Resolution settings</p> <p>The default resolution setting is [200X200dpi] in scanner and USB memory mode, and [200X100dpi] in Internet fax mode. If the original does not contain a halftone image such as a photo or illustration, scanning at the default resolution will create a practical and useful image. A higher resolution setting or the "Half Tone" setting (in Internet fax mode) should only be selected if the original contains a photo and you wish to give priority to the quality of the photo image. Exercise caution in this case as a larger file will be created than when the default setting is used.</p>
A destination is pre-selected.	Is "Default Address Setting" enabled in the system settings (administrator)?	<p><b>If you wish to send to a destination other than the default destination, touch the [Cancel] key.</b></p> <p>If you are the administrator and wish to change or disable the default destination, change the settings as appropriate in "Default Address Setting".</p> <p>→ System Settings (Administrator) &gt; "Image Send Settings" &gt; "Scan Settings" &gt; "Default Address Setting"</p>
Cannot write to USB memory. (When using USB Memory Scan.)	Is the connected USB device recognized correctly?	<p><b>Use "USB-Device Check" in the system settings to check whether or not the device can be recognized.</b></p> <p>→ System Settings &gt; "USB-Device Check"</p> <p>If it is not recognized, connect it once again.</p>

# PROBLEMS RELATED TO SCAN RESULTS

Problem	Point to check	Solution
The scanned image is clipped.	Is the original scan size setting smaller than the actual original size?	<p><b>Set the scan size to the actual original size.</b></p> <p>If you have intentionally set a smaller size than the actual original size, note carefully the placement position of the selected scan size when placing the original. For example, when scanning an 8-1/2" x 11" (A4) original using a 5-1/2" x 8-1/2" (B5) setting on the document glass, align the original using the document glass scale at the left center to fit the area you wish to scan into the 5-1/2" x 8-1/2" (B5) scanning area.</p> <p> 1. BEFORE USING THE MACHINE "PLACING THE ORIGINAL ON THE DOCUMENT GLASS" (page 1-41)</p>
The quality of the scanned image is poor.	Is the original printed matter such as a book or magazine?	<p><b>Use the following method to reduce the occurrence of vertical patterns (moiré)</b></p> <p>When the original is printed matter, vertical patterns (moiré) may occur. Touch the [Exposure] key in the base screen to open the exposure setting screen. The [Moiré Reduction] checkbox appears in this screen. This checkbox can be selected <input checked="" type="checkbox"/> to reduce the moiré effect. (only in scan mode and USB memory scan mode)</p> <p>It may also be possible to reduce the moiré effect by changing the resolution setting or shifting the original (or changing its angle) slightly on the document glass.</p>
	When scanning a color or grayscale original, is the color mode set to "Mono2"?	Setting the color mode to "Mono2" replaces the colors in the original with either black or white. This is suitable for text-only originals; however, originals with illustrations should be scanned with the color mode set to [Grayscale], [Full Color], or [Auto] - [Grayscale].
	Is a destination included that has [TIFF-S] selected for the format?	<p><b>If you wish to send an image scanned at high resolution to scan mode destinations, send the image in a separate transmission.</b></p> <p>When a broadcast transmission is performed that includes both scan mode destinations and Internet fax destinations that have [TIFF-S] selected for the format, the resolution will remain fixed at [200X200dpi] even if a different resolution setting is selected.</p>
The scanned image is blank.	Is the original placed face up or face down correctly?	<p><b>Reload the thermal paper correctly and send the fax again.</b></p> <p>When using the document glass, the original must be placed face down. When using the automatic document feeder, the original must be placed face up.</p>
The scanned image is upside down or on its side.	Are Internet fax addresses included in the transmission?	<p><b>Send the image to the scan mode destinations in a separate transmission.</b></p> <p>When both scan mode and Internet fax destinations are included in a broadcast transmission, the original transmission orientation of Internet fax takes precedence, and thus the file may not appear in the correct orientation when viewed on a computer.</p>

Problem	Point to check	Solution
<b>The scanned image is black and white.</b>	Are Internet fax or fax destinations included?	If Internet fax or fax destinations are included, scanning will only take place in black and white.
<b>JPEG was selected for the file type but the file was created as a TIFF file.</b>	Is the color mode set to [Mono2]?	<b>Change the color mode to [Full Color] and then press the [START] key.</b> When [JPEG] is selected for the file type and the image is scanned in Mono 2, the file will be created as a TIFF file.
<b>The image is too light or too dark. (When using PC Scan.)</b>	Is the threshold value suitable?	<b>Check the "B/W Threshold" setting.</b> When scanning from the TWAIN driver with [Mono 2 gradation] selected from the [Color Mode] of the "Custom Settings" window, check the "B/W Threshold" setting. A large threshold value makes the image darker and a small threshold value makes the image brighter. To adjust the "B/W Threshold" automatically, click the [Auto Threshold] button on the [Image] tab of the "Custom Settings" window.
	Are the brightness and contrast settings suitable?	When the brightness and contrast settings are not suitable (for example, the scanned image is too bright), click the [Auto Brightness / Contrast Adjustment] button on the [Color] tab of the "Custom Settings" window. You can also click the [Brightness / Contrast] button to set the brightness and contrast while viewing the scanned image.

# PROBLEMS RELATED TO ONE-TOUCH INDIVIDUAL KEYS / GROUP KEYS

Problem	Point to check	Solution
A one-touch individual key or group key cannot be stored.	Has the maximum number of keys been stored?	<b>Adjust the number of stored keys.</b> Delete one-touch keys (or group keys) that are not being used.
	Have functions been disabled by the administrator?	<b>Check with your administrator.</b> Some functions may have been disabled in the system settings (administrator).
A one-touch individual key or group key cannot be edited or deleted.	If the key is an individual key, is the key included in a group?	<b>Remove the key from the group and then edit or delete the key.</b> (If the key is included in multiple groups, it must be removed from all groups.) → System Settings > "Address Control" > "Address Book"  If multiple group keys have been stored, print the Group List in "Sending Address List" in the system settings. The list will show where the key is stored. → System Settings > "List Print (User)" > "Sending Address List" > "Group List"
	Is the key being used in a reserved transmission or a transmission in progress?	<b>Wait until the transmission is finished or cancel the transmission and then edit or delete the key.</b>
	Is the key included in a program key?	<b>Remove the key from the program and then edit or delete the key.</b> (If the key is included in program, it must be removed from program.) → System Settings > "Address Control" > "Program"  If multiple program keys have been stored, print the Program List in "Sending Address List" in the system settings. The list will show where individual and group keys are stored. → System Settings > "List Print (User)" > "Sending Address List" > "Program List"
	Have functions been disabled by the administrator?	<b>Check with your administrator.</b> Some functions may have been disabled in the system settings (administrator).
	Has your administrator enabled a function that prevents editing/deleting?	<b>Check with your administrator.</b> If your administrator has enabled "Default Address Setting" (on the machine) or "Inbound Routing Settings" (in the Web pages), editing/deleting will not be possible.

# DOCUMENT FILING

## PROBLEMS RELATED TO FILING

- Document filing does not take place. . . . .8-39
- A filed data can not be printed. . . . .8-40
- A job cannot be stored in a custom folder. . . . .8-40

## PROBLEMS RELATED TO FILE MANAGEMENT

- A stored file has disappeared. . . . .8-40
- A file cannot be deleted. . . . .8-40
- The property of a file cannot be set to [Confidential]. . . . .8-40
- A confidential file or confidential folder cannot be opened.. . . .8-40
- A file name cannot be stored or changed. . . . .8-41
- A custom folder name cannot be stored or changed. . . . .8-41
- A file name is cut off.. . . .8-41

- If you cannot find the item that you are looking for in the above table of contents, see "[GENERAL PROBLEMS](#)" (page 8-42).
- If you are unable to solve a problem using the solutions in this manual, switch off the [POWER] key (⏻) and the main power switch. Wait at least 10 seconds, and then switch on the main power switch and the [POWER] key (⏻) in that order.

### Caution:

**When the LINE indicator is lit or the DATA indicator is lit or blinking, do not switch off the main power switch or unplug the power plug. This may damage the hard drive or cause the data being stored or received to be lost.**

## PROBLEMS RELATED TO FILING

Problem	Point to check	Solution
Document filing does not take place.	Did you select document filing settings in the printer driver?	<b>Enable document filing settings.</b> In print mode, enable document filing on the [Job Handling] tab of the printer driver. In copy mode or image send mode, touch the [Quick File] key or the [File] key and then use the document filing function.
	Have functions been disabled by the administrator?	<b>Check with your administrator.</b> Some functions may have been disabled in the system settings (administrator). Check with your administrator. When user authentication is enabled, the functions that you can use may be restricted in your user settings. Check with your administrator.

Problem	Point to check	Solution
<b>A filed data can not be printed.</b>	Have functions been disabled by the administrator?	<b>Check with your administrator.</b> Some functions may have been disabled in the system settings (administrator). Check with your administrator. When user authentication is enabled, the functions that you can use may be restricted in your user settings. Check with your administrator.
<b>A job cannot be stored in a custom folder.</b>	Do custom folders appear in "Folder Information"? (When printing)	<b>Click the [Get Folder Name] button in the document filing save screen of the printer driver to call up the custom folders that have been created on the machine.</b>
	Does the custom folder have a password?	<b>Enter the password configured in the machine in the document filing save screen.</b>

## PROBLEMS RELATED TO FILE MANAGEMENT

Problem	Point to check	Solution
<b>A stored file has disappeared.</b>	Did you touch the [Print and Delete the Data] key to print a stored file?	A file that is printed using the [Print and Delete the Data] key is automatically deleted after being printed. To print a file without deleting it, use the [Print and Save the Data] key. The file property can be set to "Protect" to prevent the file from being easily deleted.
	Has automatic deletion of document filing files been enabled?	<b>If files that you need have been deleted, consult the administrator of the machine.</b> When "Automatic Deletion of File Settings" is enabled in the system settings (administrator), the files in the specified folders are periodically deleted. (Even when the file property is "Confidential" or "Protect", the file may be deleted.)
<b>A file cannot be deleted.</b>	Is the property of the file set to [Protect]?	<b>Change the property to [Sharing] and then delete the file.</b> A file cannot be deleted when its property is set to [Protect].
<b>The property of a file cannot be set to [Confidential].</b>	Is the file in the Quick File folder?	<b>Move the file to a different folder and then specify "Confidential".</b> "Confidential" cannot be specified for a file in the Quick File folder. (Note that "Protect" can be specified for a file in the Quick File folder to prevent it from being easily deleted.)
<b>A confidential file or confidential folder cannot be opened.</b>	Did you enter the wrong password?	<b>Ask your administrator.</b> If you cannot remember the password, it is possible to change the file or folder password to a new password in the system settings (administrator).

Problem	Point to check	Solution
A file name cannot be stored or changed.	Does the name include characters that cannot be used in a file or folder name?	<b>The following characters cannot be used in a file or folder name:</b> \ ? / " ; : , < > ! * & #
A custom folder name cannot be stored or changed.		
A file name is cut off.	Was the file name stored in the advanced transmission settings during a scan or Internet fax transmission?	If the name was stored in the advanced transmission settings before Quick File or File settings were configured, that name will be used for the stored file. If the number of characters in the name exceeds the maximum number of characters allowed for a Quick File name (30 characters), the characters after the 30th character will be discarded.



# GENERAL PROBLEMS

## PROBLEMS RELATED TO MACHINE OPERATION

- Specified machine functions cannot be used. . . . . 8-43
- The operation panel cannot be used. . . . . 8-43
- Printing is not possible or stops during a job. . . . . 8-44
- The wrong size is selected. . . . . 8-44
- The displayed bypass tray paper size is not correct. . . . . 8-44

## PROBLEMS RELATED TO PAPER FEEDING AND OUTPUT

- The original misfeeds (automatic document feeder). . . . . 8-45
- The paper misfeeds. . . . . 8-45
- Paper does not feed from the paper tray. . . . . 8-46
- The image on paper is skewed. . . . . 8-46
- The automatic document feeder does not operate. . . . . 8-46

## PROBLEMS RELATED TO QUALITY / PRINT RESULTS

- Lines appear in the scanned image. . . . . 8-46
- Smudges appear on printed output. . . . . 8-47
- Toner does not adhere well or creases appear in the paper. . . . . 8-47
- Print quality is poor. . . . . 8-47
- Part of the image is cut off. . . . . 8-48
- Printing takes place on the wrong side of the paper. . . . . 8-48
- A cover or insert is not printed on the specified paper. . . . . 8-48

## PROBLEMS RELATED TO PERIPHERAL DEVICES

- The connected USB device cannot be used. . . . . 8-48
- The connected USB memory cannot be used. . . . . 8-48
- The finisher does not operate. . . . . 8-49
- Stapling does not take place. . . . . 8-49
- The stapling position is not correct. . . . . 8-49
- Output does not collect neatly in the output tray of the finisher. . . . . 8-49
- Stapled output does not collect neatly. . . . . 8-49

## OTHER PROBLEMS

- Preview images or thumbnail images do not appear. . . . . 8-50
- The touch panel screen is difficult to view. . . . . 8-50
- You were logged out without having performed logout yourself. . . . . 8-50
- You forgot the administrator password. . . . . 8-50

If you are unable to solve a problem using the solutions in this manual, switch off the [POWER] key (⏻) and the main power switch. Wait at least 10 seconds, and then switch on the main power switch and the [POWER] key (⏻) in that order.

### Caution:

**When the LINE indicator is lit or the DATA indicator is lit or blinking, do not switch off the main power switch or unplug the power plug. This may damage the hard drive or cause the data being stored or received to be lost.**

# PROBLEMS RELATED TO MACHINE OPERATION

Problem	Point to check	Solution
Specified machine functions cannot be used.	Have functions been disabled by the administrator?	<p><b>Check with your administrator.</b></p> <p>Some functions may have been disabled in the system settings (administrator). Check with your administrator. When user authentication is enabled, the functions that you can use and page counts may be restricted in your user settings.</p>
The operation panel cannot be used.	Is the main power indicator lit?	<p><b>Make sure that the power plug is firmly inserted in the power outlet, switch the main power switch to the "on" position, and press the [POWER] key (⏻) to turn on the power.</b></p>
	Did you just power on the machine?	<p><b>Wait until a message appears indicating that the machine is ready.</b></p> <p>After the [POWER] key (⏻) is turned on, the machine requires some time to complete warmup operation. During this time functions can be selected, however, a job cannot be run.</p>
	Is the [POWER SAVE] key (⏻) blinking?	<p>Press the [POWER SAVE] key (⏻) to turn off Auto Power Shut off mode.</p> <p>1. BEFORE USING THE MACHINE "[POWER SAVE] KEY" (page 1-16)</p>
	Is a cover open or a device separated from the machine?	<p><b>Read the message and take appropriate action.</b></p> <p>A warning message will appear when a cover is open or a device is separated from the machine.</p>
	Did login fail three times in a row?	<p><b>Log in using the correct user information.</b></p> <p>When "A Warning when Login Fails" is enabled in the system settings (administrator) and login fails 3 times in a row, a warning will be displayed and operation will lock for 5 minutes. After operation unlocks, log in using the correct user information. (If you do not know your user information, contact your administrator.)</p>
	Does a message appear indicating that Auto Login failed?	<p><b>Contact your administrator.</b></p> <p>Auto Login failed due to a problem on the network. If you are the administrator, touch the [Admin Password] key, log in as an administrator, and temporarily change the auto login settings in the system settings (administrator). (Restore the changed settings to their original state after the network problem has been solved.)</p>

Problem	Point to check	Solution
<b>The operation panel cannot be used.</b>	Does the message "Call for service. Code:xx-xx*" appear in the touch panel? *Letters and numbers appear in xx-xx.	<b>Switch the power off and then restart the machine.</b> Make sure that the LINE indicator is not lit and that the DATA indicator is not blinking or lit and then switch off the [POWER] key (⏻) and the main power switch. Wait at least 10 seconds and then switch the main power switch and the [POWER] key (⏻) back on in that order. If the message still appears after switching the [POWER] key (⏻) and main power switch off and on several times, it is likely that a failure has occurred that requires service. In this event, stop using the machine, unplug the power plug, and contact your dealer or nearest SHARP Service Department. (When contacting your dealer or nearest SHARP Service Department, inform them of the displayed error code.)
<b>Printing is not possible or stops during a job.</b>	Is a tray out of paper?	<b>Add paper as instructed by the message in the touch panel.</b>
	Is the machine out of toner?	<b>Replace the toner cartridge.</b> When toner runs low, a message will appear to inform you that the toner cartridge must be replaced. To replace the toner cartridge, see the Start Guide
	Has a paper misfeed occurred?	<b>Remove the misfeed as instructed by the message in the touch panel.</b> 👉 <a href="#">REMOVING MISFEEDS</a> (page 8-10)
	Is the output tray full?	<b>Remove the output from the tray and resume printing.</b> When the output tray becomes full, a detector activates and stops printing.
	Is the toner collection container full?	Replace the toner collection container as instructed by the message in the touch panel. 👉 Start Guide
	In the Paper Tray Settings of the system settings, are restrictions placed on the trays that can be used in each mode (copy, print, fax, Internet fax, and document filing)?	<b>Check the Paper Tray Settings and see if checkmarks appear in the checkboxes of each mode (Feeding Approved Job).</b> Functions without a checkmark cannot be used for printing using that tray. → System Settings > "Paper Tray Settings" > "Tray Settings" > "Change" > <input checked="" type="checkbox"/> (Each mode)
<b>The wrong size is selected.</b>	Has the correct original size been set?	When an original is placed, the detected original size is displayed. If the original size displayed in this key is different from the size of the original you placed, be sure to touch this key and specify the correct size.
<b>The displayed bypass tray paper size is not correct.</b>	Is the bypass tray extension pulled out?	<b>Pull out the bypass tray extension.</b> When loading paper in the bypass tray, be sure to pull out the extension to enable the paper size to be detected correctly.

# PROBLEMS RELATED TO PAPER FEEDING AND OUTPUT

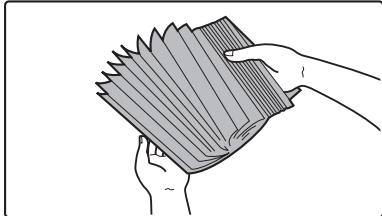
Problem	Point to check	Solution
<b>The original misfeeds (automatic document feeder).</b>	Is too much paper loaded in document feeder tray?	<b>Make sure that the stack of paper in the tray is not higher than the indicator line.</b>
	Is the original a long original?	<b>When using the automatic document feeder to scan a long original, set the scan size to [Long Size].</b> (Note that long originals cannot be copied using the copy function.)
	Is the original on thin paper?	<b>Use the document glass to scan the original.</b> If you need to use the automatic document feeder, use slow scan mode in the special modes to scan the original.
	Is the feed roller dirty?	<b>Clean the surface of the original feed roller.</b> ☞ Start Guide
<b>The paper misfeeds.</b>	Is a torn piece of paper remaining in the machine?	<b>Make sure all paper is removed.</b> ☞ <a href="#">REMOVING MISFEEDS</a> (page 8-10)
	Is too much paper loaded in the tray?	<b>Make sure that the stack of paper in the tray is not higher than the indicator line.</b>
	Are multiple sheets feeding at once?	<b>Fan the paper well before loading it.</b> 
	Are you using paper that is not within the specifications?	<b>Use SHARP-recommended paper.</b> Using paper that is not supported may result in misfeeds, creases, or smudges. Please use SHARP-recommended paper and label sheets. For details, contact your dealer or nearest SHARP Service Department. For paper that is prohibited or not recommended, see " <a href="#">USEABLE PAPER</a> " (page 1-27) in "1. BEFORE USING THE MACHINE".
	Has the paper in the tray absorbed moisture?	If you will not be using paper in a tray for a long time, remove the paper from the tray and store it in a bag in a dark and dry location.
	Are the bypass tray guides adjusted to the width of the paper?	<b>Adjust the bypass tray guides to the width of the paper.</b>
	Is the bypass tray extension pulled out?	<b>When loading a large size of paper, pull out the extension.</b>
	Is the bypass feed roller dirty?	Clean the surface of the bypass feed roller. ☞ Start Guide

Problem	Point to check	Solution
The paper misfeeds.	Has the correct paper size been set?	<b>If you are using a special size, be sure to specify the paper size.</b> If the size of paper loaded in a tray was changed, be sure to check the paper size setting. → System Settings > "Paper Tray Settings" > "Tray Settings"
	Did you add paper to the bypass tray?	<b>When adding paper, remove any paper remaining in the bypass tray, combine it with the paper to be added, and reload as a single stack.</b> If paper is added without removing the remaining paper, a misfeed may result.
Paper does not feed from the paper tray.	Is the paper loaded correctly in the paper tray?	<b>Set the guides to the size of the paper.</b> Make sure the height of the paper does not exceed the indicator line.
	In the Paper Tray Settings of the system settings, are restrictions placed on the trays that can be used in each mode (copy, print, fax, Internet fax, and document filing)?	<b>Check the Paper Tray Settings and see if checkmarks appear in the checkboxes of each mode (Feeding Approved Job).</b> Functions without a checkmark cannot be used for printing using that tray. → System Settings > "Paper Tray Settings" > "Tray Settings" > "Change" > <input checked="" type="checkbox"/> (Each mode)
The image on paper is skewed.	Is too much paper loaded in the bypass tray?	<b>Do not load more than the maximum number of sheets.</b> The maximum number of sheets varies depending on the paper type setting. For more information, see "SPECIFICATIONS" in the Start Guide.
	Are the bypass tray guides adjusted to the width of the paper?	<b>Adjust the bypass tray guides to the width of the paper.</b>
	Are the original guides adjusted to the width of the paper?	<b>Adjust the original guides to the width of the paper.</b>
The automatic document feeder does not operate.	Have functions been disabled by the administrator?	<b>Check with your administrator.</b> Some functions may have been disabled in the system settings (administrator).

## PROBLEMS RELATED TO QUALITY / PRINT RESULTS

Problem	Point to check	Solution
Lines appear in the scanned image.	Are the scanning areas of the document glass or automatic document feeder dirty?	<b>Clean the scanning areas of the document glass or automatic document feeder.</b> ☞ Start Guide
	Is the paper feed roller or the bypass feed roller dirty?	<b>Clean the surface of the paper feed roller or the bypass feed roller.</b> ☞ Start Guide

Problem	Point to check	Solution
<b>Smudges appear on printed output.</b>	Are you using paper that is not within the specifications?	<b>Use SHARP-recommended paper.</b> Using paper that is for other models or special paper that is not supported may result in misfeeds, creases, or smudges. For details, contact your dealer or nearest SHARP Service Department.
	Are you printing on pre-punched paper?	<b>Take care that the image does not overlap the punch holes.</b> If the printed image overlaps the punch holes, smudges may appear on the reverse side of the paper following one-sided printing, or on both sides following two-sided printing.
	Is the laser unit, the main charger, or the PT charger dirty?	If these units are dirty, smudges appear upon print results. Clean these units periodically. For cleaning, see "Start Guide".
	Does a message appear indicating the need for maintenance?	<b>Contact your dealer or nearest SHARP Service Department as soon as possible.</b>
<b>Toner does not adhere well or creases appear in the paper.</b>	Are you using paper that is not within the specifications?	<b>Use SHARP-recommended paper.</b> Using paper that is for other models or special paper that is not supported may result in misfeeds, creases, or smudges. For details, contact your dealer or nearest SHARP Service Department.
	Did you set the correct paper type?	<b>Set the correct paper type in the tray settings.</b> Make sure that the following has not occurred: <ul style="list-style-type: none"> <li>• Heavy paper is being used, but a paper type other than heavy paper is selected in the tray settings. (The image may disappear if rubbed.)</li> <li>• Paper other than heavy paper is being used, but heavy paper is selected in the tray settings. (This may cause creases and misfeeds.)</li> </ul> → System Settings > "Paper Tray Settings" > "Tray Settings"
	Is the paper loaded so that printing takes place on the reverse side?	<b>Check that the paper is loaded so that printing takes place on the correct side.</b> If printing takes place on the wrong side of label sheets or transparency film, the toner may not adhere well and a clear image may not be obtained.
<b>Print quality is poor.</b>	Is "Toner Save Mode" enabled?	<b>Check with your administrator.</b> When "Toner Save Mode" is enabled, printing takes place using less toner and thus the print result is lighter.

Problem	Point to check	Solution
Part of the image is cut off.	Has the correct paper size been set?	<b>If you are using a special size, be sure to specify the paper size.</b> If the size of paper loaded in a tray was changed, be sure to check the paper size setting. → System Settings > "Paper Tray Settings" > "Tray Settings"
	Was the original placed in the correct position?	<b>If you are using the document glass, be sure to place the original in the left center of the document glass.</b> 1. BEFORE USING THE MACHINE "PLACING THE ORIGINAL ON THE DOCUMENT GLASS" (page 1-41)
Printing takes place on the wrong side of the paper.	Is the paper loaded with the print side facing in the correct direction?	<b>Check that the paper is loaded so that printing takes place on the correct side.</b> <ul style="list-style-type: none"> <li>• Trays 1 to 4: Load the paper with the front side facing up*.</li> <li>• Bypass tray: Load the paper with the front side facing down*.</li> </ul> * When the paper type is "Pre-Punched", "Pre-Printed" or "Letter Head", load the paper in the opposite way. (Except when "Disabling of Duplex" is enabled in the system settings (administrator). For the current setting, check with your administrator.)
A cover or insert is not printed on the specified paper.	Has the paper type been set correctly?	<b>Set the correct paper type for the tray that contains the paper specified for the cover or insert.</b> If the paper type set for the cover or insert is not the same as the paper type set for the tray, paper will be fed from a different tray. → System Settings > "Paper Tray Settings" > "Tray Settings"



## PROBLEMS RELATED TO PERIPHERAL DEVICES

Problem	Point to check	Solution
The connected USB device cannot be used.	Is the USB device compatible with the machine?	<b>Ask your dealer if the device is compatible with the machine.</b>
	Is the connected USB device recognized correctly?	<b>Use "USB-Device Check" in the system settings to check whether or not the device can be recognized.</b> → System Settings > "USB-Device Check" If it is not recognized, connect it once again.
The connected USB memory cannot be used.	Is the format of the USB memory FAT32?	<b>Check the USB memory device format.</b> If the format of the USB memory is other than FAT32, use your computer to change the format to FAT32.
	Are you using a USB memory with a capacity of more than 32 GB?	<b>Use a 32-GB or less USB memory.</b>

Problem	Point to check	Solution
<b>The finisher does not operate.</b>	Does a message appear indicating that you need to remove paper from the stapler compiler?	Remove all remaining paper from the stapler compiler.
	Does the following message appear in the touch panel? "Call for service. Code:xx-xx. Finisher trouble." *Letters and numbers appear in xx-xx.	<b>Check the connection cable.</b> Remove and then firmly reinsert the connection cable, and restart the machine.
<b>Stapling does not take place.</b>	Does a message appear instructing you to check the staple unit?	<b>Remove jammed staples.</b> ☞ "REMOVING STAPLE JAMS" (page 8-15)
	Does a message appear instructing you to add staples?	<b>Replace the staple cartridge.</b> Do not forget to replace the staple case. ☞ "REMOVING STAPLE JAMS" (page 8-15)
	Is a different width of paper mixed in?	<b>To perform mixed size stapling, use paper of the same width.</b> Stapling is not possible when paper of different widths are mixed together. When copying, select [Mixed Size Original] in the special modes.
	Are there more sheets than can be stapled at once?	<b>For the maximum number of sheets that can be stapled, see "SPECIFICATIONS" in the Start Guide.</b>
	Is a paper size that cannot be stapled included in the print job?	<b>For the paper sizes that can be stapled, see "SPECIFICATIONS" in the Start Guide.</b>
	Is the paper type setting of the tray selected in the printer driver set to a paper type that cannot be stapled?	Check the paper type settings in the machine and select a tray that has paper that can be used for stapling*. Click the [Tray Status] button in "Paper Selection" on the [Paper] tab of the printer properties window and check the paper type setting of each tray. * Stapling is not possible on labels, transparency film, or envelopes. In addition, if "Disable Staple" is selected in the user type, stapling will not be possible.
	Have functions been disabled by the administrator?	<b>Check with your administrator.</b> Some functions may have been disabled in the system settings (administrator).
<b>The stapling position is not correct.</b>	Is the stapling position set correctly?	<b>Check the stapling position setting.</b> ☞ 2. COPIER "OUTPUT" (page 2-35)
<b>Output does not collect neatly in the output tray of the finisher.</b>	Is the paper curled?	It may help to turn the paper over in the paper tray.
<b>Stapled output does not collect neatly.</b>	Is the paper curled?	It may help to turn the paper over in the paper tray.



## OTHER PROBLEMS

Problem	Point to check	Solution
Preview images or thumbnail images do not appear.	Are there a number of jobs waiting to be executed?	Wait until several of the jobs have been executed.
The touch panel screen is difficult to view.	Is the display contrast properly adjusted?	<p><b>Touch the brightness adjustment key (  ) on the system bar in the touch panel to adjust the brightness.</b></p> <p> 1. BEFORE USING THE MACHINE "SYSTEM BAR" (page 1-13)</p>
You were logged out without having performed logout yourself.	Did Auto Clear activate?	<p><b>Log in again.</b></p> <p>When user authentication is used, the currently logged in user will be automatically logged out if Auto Clear activates. (Except when in PC scan mode.)</p> <p>If you are the administrator, you can change the time setting of Auto Clear or disable Auto Clear in "Auto Clear Setting".</p> <p>→ System Settings (Administrator) &gt; "Operation Settings" &gt; "Other Settings" &gt; "Auto Clear Setting"</p>
You forgot the administrator password.	Was the administrator password changed from the factory default setting?	<p>Contact your dealer or nearest SHARP Service Department.</p> <p>For the factory default administrator password, see "TO THE ADMINISTRATOR OF THE MACHINE" in the Maintenance &amp; Safety Guide. After changing the password, take special care to remember it.</p>



**SHARP®**

**SHARP ELECTRONICS CORPORATION**

1 Sharp Plaza, Mahwah, New Jersey 07495-1163.

[www.sharppusa.com](http://www.sharppusa.com)

**SHARP ELECTRONICS OF CANADA LTD.**

335 Britannia Road East, Mississauga, Ontario, L4Z 1W9

**SHARP CORPORATION**